

# 2014/2015 CATALOG HARRIS-TELLER INC.

**800-252-4004**

OR

**708-496-2100**

FAX NUMBERS

**888-983-5537**

(888-9TELLER)

OR

**708-496-2130**

E-MAIL

[sales@harristeller.com](mailto:sales@harristeller.com)

WEB SITE

[www.harristeller.com](http://www.harristeller.com)

Others may claim "fast service" and "complete stock." Our many satisfied customers know that day in and day out through school season and Christmas rush, we give the fastest service, highest percentage of fill, fair competitive prices and honest treatment.

**VISA/MASTER CARD/DISCOVER ACCEPTED**

#### **ORDERING INFORMATION**

We require orders to be a minimum of **\$50.00 NET** due to additional handling. Our computerized order entry system gives us instant inventory and pricing information. Orders are processed immediately. We cannot guarantee to cancel, add to, or change orders after they have been entered.

#### **RETURNS FOR CREDIT**

All items returned for credit must be current stock items, in original cartons, and in resaleable condition. All accessories and manuals, etc. must be returned with the item. Ship all items in a protective carton. Please include your invoice with the reason(s) you are returning the merchandise. Lack of invoice numbers will delay the processing of your credit.

Harris-Teller reserves the right to charge a **15% restocking charge** on all returned goods and to reduce the amount of credit or to return the item uncredited if the unit is not in full resaleable condition. Dealer is responsible for shipping charges on all returns (unless due to unit defect).

#### **FACTORY WARRANTY**

Most goods manufactured in the United States are warranted by the factory. In the event a problem should arise, it is to the buyer's advantage to deal directly with the manufacturer. To expedite handling, give specific details of the problem involved and be sure to include your return address. We will send the manufacturer's address upon request.

#### **PRICES ARE SUGGESTED RETAIL.**

**ALL RETURNED CHECKS ARE SUBJECT TO A SERVICE CHARGE OF \$30.00  
WE RESERVE THE RIGHT TO CORRECT TYPOGRAPHICAL & PHOTOGRAPHICAL ERRORS  
PRICES SUBJECT TO CHANGE WITHOUT NOTICE**

We cannot guarantee that published prices in this catalog will remain constant.

For the current price on any item, please call our sales department.

**HARRIS-TELLER INC.**

**7400 S. MASON AVE.**

**CHICAGO, IL 60638**

# HARRIS-TELLER 2014/2015 CATALOG

## TABLE OF CONTENTS

### I. GUITAR AND RELATED PRODUCTS

A. GUITARS, BASSES, UKES, UKE BAGS, MANDOLINS, BANJOS & DULCIMERS.....	4-18
B. CASES, BAGS & HUMIDIFIERS.....	19-23
C. STRAPS, STRAPLOCKS, GUITAR TOOLS, FOOT STOOLS & GRIPS.....	24-45
D. GUITAR STRINGS.....	46-68
E. TUNING FORKS, PITCH PIPES, POLISH & CLOTHS.....	69-71
F. CAPOS, STRING WINDERS, SLIDES & STEEL BARS.....	72-75
G. HARDWARE, BRIDGES, STRING WINDERS, NECKS, BODIES & GRAPH TECH, Q-PARTS, FENDER PARTS.....	76-90
H. PICK GUARD, KNOBS, SWITCHES, BRIDGE PINS, GUITAR BRIDGES, BANJO BRIDGES & PICKS.....	91-111
I. TUNING MACHINES, BANJO, GUITAR, MANDOLIN, TAILPIECES & PEGS.....	112-117
J. GUITAR STANDS, DISPLAYS & HOOKS.....	118-122

### II. PERCUSSION

A. WIND CHIMES & TRIANGLES.....	123-124
B. ZILDJIAN CYMBALS, GEARS & ACCESSORIES.....	125-140
C. POLISH, CYMBAL BAGS & CYMBAL CASES.....	141-142
D. THRONES, STANDS & PEDALS.....	143-147
E. MOUNTING, REPLACEMENT PARTS & HOOPS.....	148-152
F. COWBELLS, DRUM KEYS, WOODBLOCKS, HOLDERS & SHAKERS.....	153-156
G. PERCUSSION TABLES, SHAKERS, WASHBOARD & WHISTLES.....	157-160
H. SLEIGH BELLS, DIDJERIDOO, PAN PIPES & THUMB PIANO.....	160-161
I. SHEKERE, CONGAS, CAJON, DJEMBES, HANDDRUMS, BONGO & BAGPIPES.....	162-171
J. TIMBALES, DRUMS, BELL SETS, SNARE KITS & TAMBOURINES.....	172-181
K. DRUM BAGS, COVERS, CARRIERS, SLINGS & PRACTICE PADS.....	182-184
L. STICKS, MALLETS, BRUSHES & STICK BAGS.....	185-208
M. DRUM HEADS AND SOUND CONTROLLERS, ROCK 'N ROLL CARTS & KICKPORT.....	209-231

### III. ELECTRONICS AND KEYBOARDS

A. MICROPHONES (WIRED AND WIRELESS), PORTABLE P.A.....	232-243
B. HEADPHONES.....	244-246
C. SPEAKERS.....	247-248
D. MICROPHONE STANDS & ACCESSORIES.....	249-257
E. ADAPTORS, CABLES, TUBES, NOISE FILTERS & A/B-DIRECT BOXES.....	258-275
F. PICKUPS.....	276-284
G. ADAPTORS, HEADPHONE AMPS, PEDALS, EFFECTS, TUNERS, PRO AUDIO/RECORDING & GIG BAGS.....	285-324
H. CHAUVET LIGHTING.....	325-328
I. SOUND REINFORCEMENT/AMPS, AMP/MONITOR STANDS & SKB CASES/BAGS.....	329-337
J. KEYBOARDS & STANDS/CASES/BAGS/COVERS.....	338-343

### IV. SMALL INSTRUMENTS AND PRE-BAND

A. HARMONICAS, CONCERTINAS, ACCORDIANS & HARP MICS.....	344-346
B. RHYTHM BAND, RECORDERS, BATONS (CONDUCTING) (TWIRLING), WRIGHT WAY TEACHING AIDS, KAZOOS, NOVELTIES, MELODICAS & TIN WHISTLES.....	347-354

**V. EDUCATIONAL NEEDS**

A. MUSIC STANDS, FOLDERS & iPad/TABLET HOLDERS.....355-359  
B. LAMPS & TEXT BOOKS .....360-367

**VI. BOWED INSTRUMENTS AND ACCESSORIES**

A. VIOLINS, VIOLAS, CELLOS, BASSES & BOWS .....368-370  
B. BAGS, CASES & PARTS, STANDS & POLISH .....371-372  
C. SHOULDER/CHIN RESTS, ADJUSTERS, MUTES & BRIDGES.....373-374  
D. PEGS, TAILPIECES & P/Us.....375  
E. ROSIN, SOUND POSTS/SETTERS & FINGERBOARDS.....376  
F. STRINGS .....377-380

**VII. BAND AND ORCHESTRA**

A. REEDS, TRIMMERS & HOLDERS.....381-386  
B. MOUTHPIECES, PATCHES, POUCHES, PULLERS & BERPS .....387-395  
C. MUTES.....396-399  
D. BAND INSTRUMENTS.....400-402  
E. INSTRUMENT CASES & BAGS .....403  
F. STANDS & PEGS.....404-407  
G. CAPS, LIGATURES, LYRES & DISINFECTANTS.....408-412  
H. CLEANING & MAINTENANCE PRODUCTS.....413-418  
I. POLISH, OILS & CORK GREASE .....419  
J. STRAPS & HARNESSSES.....420-422  
K. VALENTINO REPAIR PARTS, WORK MATS & PIANO TUNING HAMMERS .....423  
L. METRONOMES.....424-425

**VIII. BOUTIQUE ITEMS, VIDEOS AND PEAVEY**

A. ZILDJIAN BASICS .....426  
B. AWARD PINS & MERCHANDISE BAGS .....427  
C. HALBE STATUETTES, GIFTS, PINS & EARRINGS .....428-429  
D. IMPRINT ITEMS .....430-431  
E. DISPLAY FIXTURES .....432-438  
F. APPAREL, FENDER & ERNIE BALL.....439-442

**IX. INDEX .....443-445**

IF THERE IS SOMETHING YOU CANNOT FIND, PLEASE CALL US AT 800-252-4004. WE ADD NEW LINES AND PRODUCTS TO OUR INVENTORY THROUGHOUT THE YEAR.

OUR PRINT MUSIC DIVISION STOCKS A COMPREHENSIVE LISTING OF TITLES FROM ALL MAJOR PUBLISHERS. ASK YOUR ACCOUNT MANAGER FOR INFORMATION.

*Sign up for e-mail blasts & specials at: [www.harristeller.com](http://www.harristeller.com)*

**PRICES SHOWN IN THIS CATALOG ARE SUGGESTED RETAIL,  
AND ARE SUBJECT TO CHANGE WITHOUT NOTICE.**

**HARRIS-TELLER INC.**

**800-252-4004 • 708-496-2100**

**E-MAIL: [sales@harristeller.com](mailto:sales@harristeller.com)**

**[www.harristeller.com](http://www.harristeller.com)**

**FAX: 708-496-2130**

**888-983-5537**

**(888-9TELLER)**

## SAVANNAH BANJO GUITAR



Six string Banjo guitar with mahogany resonator with thumb screws, mahogany neck with rosewood fingerboard, dot position markers, 3-ply maple rim, 24 brackets, individual geared tuners, adjustable truss rod, scale length 22<sup>3</sup>/<sub>4</sub>"", nut width 1<sup>1</sup>/<sub>16</sub>"", total length 34<sup>3</sup>/<sub>4</sub>"".

**SB106**.....\$439.55

## SAVANNAH BANJOS



### JOHNSON

Mahogany resonator with thumb screws, mahogany neck, laminate maple rim, geared 5th peg, individual geared tuning machines, 24 brackets, nickel-plated armrest. Also available left-handed (-L).

**SB080** 18 Bracket.....\$409.00  
**SB100** 24 Bracket.....\$453.65  
**SB100L** 24 Bracket, Lefty.....\$453.65



Cast aluminum rim, mahogany neck, mahogany resonator with thumb screws, planetary tuning machines, inlaid M.O.P. headstock design, bound rosewood fretboard, geared 5th peg, 30 brackets.  
**MLSB110** 30 Bracket Planetary Banjo .....\$554.70



**SB060**.....\$411.35  
 5-String Travel Banjo w/ Padded Bag

## SAVANNAH MANDOLINS



**SF120SN**

Spruce top; maple back, sides & neck; ebony bridge; nickel-plated tuning machines; sunburst satin finish; also available with pickup (-E)

**SF120SN** F Style .....\$498.20  
**SF120E** F Style.....\$557.10



Solid hand-carved spruce top, solid hand-carved maple back and sides, solid maple neck, rosewood fretboard and bridge, nickel-plated hardware.

**SF200SB** F Style Sunburst..\$655.45



Spruce top, maple back and sides, extended 24-fret fingerboard, ebony bridge, nickel tuning machine.

**SF100** F Style Sunburst w/case .....\$343.30



Hard maple neck, bound rosewood fretboard, 12th fret neck joint, adjustable compensated bridge.

**SA100** A Style.....\$125.15  
 Sunburst, BK Black

## THE LOAR



Solid hand-carved spruce top and maple back, solid maple sides, maple neck w/rounded "V" profile, bound rosewood fretboard. Bone Nut. Compensated adjustable ebony bridge. Grover tuning machines with pearlloid buttons. M.O.P. logo headstock inlay. Ivory body and neck binding. Vintage sunburst gloss finish.

**LM520VS** F Style .....\$907.50



Spruce top, maple back and sides, hard maple neck, extended 24-fret rosewood fretboard, 12th fret neck joint, adjustable compensated bridge.

**MLSA110** Oval Hole Sunburst .....\$141.15



SA-100 mandolin, instructional DVD, pitch pipe, 6 picks, padded nylon carrying bag.

**SAKIT** Sunburst .....\$243.45



Solid carved top, solid maple back, sides and neck, Gotoh machine heads, adjustable compensated rosewood bridge.

**SA120** A Style Sunburst ....\$263.60

## THE LOAR GRASSROOTS MANDOLINS



### Performer Series F-Style Mandolin

Solid hand-carved spruce top and maple back, solid maple sides, maple neck w/rounded "V" profile, bound rosewood fretboard. Bone Nut. Compensated adjustable ebony bridge. Grover tuning machines with pearloid buttons. M.O.P. logo headstock inlay. Ivory body and neck binding. Vintage sunburst gloss finish.

LM520VS .....\$907.50



### The Loar Grassroots F Style Mandolin

Solid hand carved, fully graduated spruce top, maple back and sides, Grover tuning machines, vintage sunburst matte finish, rosewood fretboard, 13<sup>39</sup>/<sub>32</sub>" scale length, 1<sup>1</sup>/<sub>8</sub>" nut width, bone nut, compensated adjustable rosewood bridge, ivory body binding, D'Addario strings.

LM370VSM .....\$708.65



### The Loar Grassroots A Style Mandolin

Solid hand carved, fully graduated spruce top, maple back and sides, Grover tuning machines, vintage sunburst matte finish, rosewood fretboard, bone nut, compensated adjustable rosewood bridge, ivory body binding, D'Addario Strings.

LM170VSM .....\$500.75

## RECORDING KING BANJOS

### Starlight Series Banjos



### Songster Resonator Banjo

Mahogany resonator, mahogany neck, rolled brass tone ring, nickel-plated flange, bound rosewood fretboard, Kershner-style tailpiece, nickel-plated hardware.

RKR20 24 Bracket .....\$845.70



### Recording King Starlight Resonator Banjo

Maple neck w/adjustable truss rod, multi-ply maple rim, steel rod tone ring, rosewood fretboard, 24 brackets w/notched tension, dual coordinator rods, presto-style tailpiece, 30s style arm-rest included, maple/ebony <sup>3</sup>/<sub>8</sub>" bridge, nickel-plated hardware. Custom starlight color series [Sky Blue (LBL), Deep Grey (DBL), Yellow (Y)].

RKS06 .....\$721.55



### Recording King Starlight Open Back Banjo

Maple neck with adjustable truss rod, Presto style tailpiece, 16 brackets, REMO recording king head. Custom starlight color series [Sky Blue (LBL), Deep Grey (DBL), Yellow (Y)].

RKS06 .....\$418.90

### Dirty 30's Series Banjos



### Recording King Dirty 30 Resonator Banjo

Maple neck with adjustable 2-way truss rod, maple resonator, adjustable coordinator rod, plate flange with 24 American threaded hooks & nuts, REMO recording king head, Presto tailpiece, maple/ebony bridge, rosewood fretboard, satin finish.

RKH05 .....\$644.05



### Recording King Dirty 30 Open Back Banjo

Maple Neck with adjustable 2-way truss rod, adjustable coordinator rod, REMO recording king head, Presto tailpiece, maple/ebony bridge, 16 brackets, rosewood fretboard, satin finish.

RKH05 .....\$413.85



### Recording King Dirty 30 Tenor Banjo

Maple Neck with adjustable 2-way truss rod, adjustable coordinator rod, Presto style tailpiece, REMO recording king heads, satin finish.

RKT05 .....\$393.05

## AXL



**AS820**.....\$320.00  
Distressed, solid alder body, distressed pickguard, 1 humbucker, 2 single coil pickups.

Available in Black (CKBK),  
Brown (BR), Brn/Crm (CKBW)



**AT820**.....\$320.00  
Distressed, solid alder body, distressed pickguard, 2 single coil pickups.

Available in  
Crackle Brown/White (CKBW)



**AL820** .....\$399.05  
Badwater single cut electric guitar.

Available in Matte Sunburst (MS),  
Off White Crackle (WO),  
Crackle Blue (CKBL)



**Hollow Body  
JH100S Sunburst** .....\$358.00

Spruce top, mahogany body, set-in mahogany neck, diecast chrome tuners, two humbucking pickups, multi-ply body binding.

## AXL

### HEADLINER SERIES



#### Headliner

Basswood body, maple neck, rosewood fretboard, 3 single coil pickups, volume/tone/tone controls and 5-way selector switch, tremolo bridge, 25½" scale length, sealed tuning machines. Available in Black (BK) or Metallic Blue (MBL). **Left handed model available in full or ¾ sizes (Black and Metallic Blue only).**

**AS754 Lefty** .....\$192.75



#### Headliner

Basswood body, maple neck, rosewood fretboard, 3 single coil pickups, volume/tone/tone controls and 5-way selector switch, tremolo bridge, 25½" scale length, sealed tuning machines. Available in Black (BK), White (W), Red (R) and Sunburst (SB) finishes. **Also available in ¾ or ½ sizes (Black, Metallic Blue and Metallic Red only).**

**AS750**.....\$189.40

## BALTIMORE



#### Bass

**BB5** Specify Color .....\$225.40  
Solid alder top, split pick up, maple neck, rosewood fingerboard.

Colors: Red (R), Black (BK),  
Sunburst (SB)

## JOHNSON



#### Thin body w/pickup

Chambered mahogany body with spruce top, maple neck, rosewood fretboard and bridge, die cast tuning machines, 4 Band EQ with tuner, bolt on neck, deep treble side cutaway, 25.5" scale length, with 1⅞" nut width.

**JG50NA** .....\$327.65

## FLINT HILL MANDOLINS



Handcarved, arched, all solid spruce top, handcarved, arched, all solid maple back and sides, Pearloid peghead overlay, mahogany neck.

**SFHM50BK Black** .....\$230.95

**SFHM50SB Sunburst** .....\$230.95



Handcarved, arched, all solid spruce top; handcarved, arched, all solid maple back and sides; Pearloid peghead overlay; long F-scale mahogany neck; dovetailed neck joint; bound, dot-inlaid rosewood fingerboard; perfectly shaped and positioned F-holes; multi-ply body binding; loar-style rosewood bridge; chrome-plated traditional tailpiece & tuners; Sunburst finish.

**SFHM75** .....\$682.40

## FLINT HILL BANJOS



5-string open back, 16 bracket w/ geared 5th peg and 11 inches composite rim, Pearloid peghead overlay, inlaid position markers, mahogany neck, rosewood, fingerboard 25½" scale, adjustable truss rod, P44 flat hook & nut set, traditional P115 "no knot" tailpiece.

**SFHB50** .....\$309.70



5-string resonator, 16 bracket, 11" molded composite rim, geared 5th peg, Pearloid peghead overlay, P44 flat hook & nut set, traditional P115 "no knot" tailpiece, mahogany neck, rosewood fingerboard, inlaid position markers, adjustable truss rod, F2000 guitar style geared tuners, 25.5" scale.

**SFHB55** .....\$367.40

## JOHNSON



**JJ200VS**.....\$420.75

The Viola bass features a flamed maple body, dual humbucking pickups with volume and tone controls, and a hard maple neck with a set construction. The 60's-style semi-hollowbody design provides tones similar to an upright bass.

**CG020VB** Case.....\$108.30  
**CG044VB** Woodcase.....155.25



**AL790**.....\$280.15

Slab-body, single cutaway body style, distressed solid mahogany body, solid mahogany set neck, rosewood fretboard, dog-ear single coil, volume & tone controls, wrap-around bridge/tailpiece, vintage style covered tuners.

Available in Antique Brown (ABR), Off White (WO), and Matte Sunburst (MS) finishes.



**Marquee MJZ AZ800**.....\$359.85

Solid alder body, rock maple bolt on neck, rosewood fretboard, 2 Alnico P-90 pickups, volume & tone controls, 3-way pickup selector switch, tremolo bridge, 25½" scale length, 1⅛" nut width, bound headstock. Available in Lake Placid Blue (BLP), and Sunburst (SB).

## JOHNSON



**Marquee Capricorn Bass AJ800**.....\$384.10

Classic double cutaway body, maple neck, rosewood fretboard, 2 single coil Alnico pickups, vintage style bridge, 34" scale length, 1½" nut width, unique 2-piece pickguard, elephant ear tuning machines.

Available in Black (BK) and Sunburst (SB) finishes



**Solara Special JL750**.....\$220.10

Basswood body, bolt on maple neck, rosewood fretboard, dual humbuckers.

Available in Sunburst (SB)

## J REYNOLDS



### Mini Electric Guitar Prelude Packs

#### Single Cutaway

29" long, 21 frets, 1 single coil pickup, 1 volume control. Available in Beautiful Black (BK), Groovy Gold (GO), Pop Princess Pink (PI), and Bodacious Blue (B).

**JRPKLP** Specify Color.....\$199.99

#### Double Cutaway

29" long, 21 frets, 1 single coil pickup, 1 volume control, 1 tone control. Available in Rockin' Red (R), Blueblast Sparkle Blue (B), Jet Black (BK), and Gold Rush (GO).

**JRPKST** Specify Color.....\$199.99

## RECORDING KING DIRTY THIRTIES



**RDH05 Dreadnought**.....\$266.10

Solid spruce top and rosewood fretboard, bone nut 1⅛" width, scale length 25.4", diecast chrome machines, rosewood bridge. Satin Sunburst.



**ROH05 000 Style**.....\$266.10

Solid spruce top and rosewood fretboard, bone nut 1¾" width, scale length 24.9", diecast chrome machines, rosewood bridge. Satin Sunburst.



**RPH05 Single O**.....\$271.50

Solid spruce top and rosewood fretboard, bone nut 1¾" width, scale length 25.4", diecast chrome machines, rosewood bridge. Satin Sunburst.

All of our Dirty Thirties guitars start with a solid spruce top and rosewood fretboard with bone nut and saddle. We've finished each guitar with classic extra-large fretboard dots, aged ivoroid body binding, satin sunburst finish, vintage-inspired tuning keys and historic Recording King headstock.

## RECORDING KING



### O BODY STYLE

Solid Sitka spruce top, mahogany back and sides, fully scalloped x-bracing, "C" profile mahogany neck, rosewood fretboard, 25.4" scale length, 1 1/4" nut width, bone nut and saddle, open geared Butterbean, tuning machines, gloss finish.

**RP06** .....\$500.65



### JUMBO BODY STYLE

Solid Sitka spruce top, mahogany back and sides, fully scalloped x-bracing, "C" profile mahogany neck, rosewood fretboard, 24.75" scale length, 1 1/8" nut width, bone nut and saddle, die cast tuning machines, gloss finish.

**RJ06**.....\$499.85

## JOHNSON



Solid spruce top, dreadnaught, white wood back and sides with visible wood grain, Nato neck, ebonized fretboard and bridge, plastic nut and saddle, Ivoroid body binding, ivory bridge pins, inlaid rosette, die-cast tuning machines, satin finish.

**JG615NA** .....\$201.95

## JOHNSON



**JG610** Dreadnaught.....\$148.45  
**34JG610** 3/4 Size .....143.60  
**12JG610** 1/2 Size .....139.80  
 N-Natural, B-Blue,  
 BK-Black, R-Red



**JG620** DreadNought .....\$168.75  
 N-Natural, BK-Black, SB-Sunburst  
**JG624N Lefty** .....\$179.55  
 N-Natural



**JG620CE** .....\$305.20  
 Cutaway Dreadnaught with active 4-band EQ Pickup. Natural top. Nato wood sides, back and neck.  
 BK-Black, SB-Sunburst



**SGD12NA** .....\$140.65  
**SGD12BK** .....145.65  
**Savannah Dreadnaught Guitar**  
 Basswood top with Sitka bracing, thin C neck, 25.4" scale, 1 1/16" nut width, bound rosewood fretboard, ivory body binding, nickel-plated hardware.  
 BK-Black, NA-Natural Gloss Finish

## JOHNSON



### THIN BODY

**JG650T** .....\$217.30  
 Spruce Top, Nato back, sides & neck, rosewood fretboard & bridge, die-cast chrome tuners, EQ pickup with tone & volume controls.  
 BK-Black, N-Natural



**JG100** .....\$113.35  
 Catalpa back, top, & sides. Maple fretboard. Gloss finish. Steel strings. Scale length 25 1/2".  
 BK-Black, B-Blue, PI-Pink  
 WL-Walnut



**JG622E** Spruce Top .....\$428.00  
 Acoustic/electric bass, diecast chrome machine heads, bound rosewood fretboard, active 4 band EQ.



**Savannah Single O Guitar**  
**SGP12NA 0** .....\$140.65  
**SGP12BK 0** .....145.65  
**Savannah 000 Guitar**  
**SGO12NA 000** .....\$140.65  
**SGO12BK 000** .....145.65  
 Basswood top with Sitka bracing, thin C neck, 25.4" scale, 1 1/16" nut width, bound rosewood fretboard, ivory body binding, nickel-plated hardware.  
 BK-Black, NA-Natural Gloss Finish



## RECORDING KING



### Classic Series

**RO06** OOO Style .....\$482.95  
Solid Sitka spruce top, mahogany neck, mahogany (-06) back & sides, ultra thin "C" profile neck, die cast tuners, rosewood fretboard.

## JOHNSON

### SONGWRITER II SERIES



**JD0612** 12 String .....\$370.70  
**JD0612L** 12 String Lefty.....\$370.70  
Dreadnought body, solid spruce top, mahogany back & sides, mahogany neck, herringbone body binding, gloss finish.



**JO06** OOO .....\$274.95  
**JD06** Dreadnaught .....\$274.95  
Solid spruce top, mahogany back & sides, mahogany neck, rosewood fretboard, herringbone body binding, gloss finish.

## JOHNSON

### TRAVELERS



**JGTR2** .....\$146.25  
Spruce top, mahogany back and sides, rosewood fretboard and bridge, scale length: 24<sup>3</sup>/<sub>4</sub>, 22 full-size frets. **Includes carrying bag.**



**JGTR12** .....\$225.10  
Spruce top, mahogany back, sides & neck, arched back for projection, rosewood fretboard & bridge, adjustable truss rod, 12th fret neck joint, scale length: 22<sup>5</sup>/<sub>8</sub>". **Includes carrying bag.**



**JGTR15** .....\$308.95  
Solid spruce top, mahogany back, sides & neck, arched back for projection, rosewood fretboard & bridge, scale length: 24<sup>3</sup>/<sub>4</sub>", 22 full-size frets. **Includes carrying bag.**

## JOHNSON



### Parlor Guitar

**JG420** .....\$168.75  
Spruce top, diecast tuning machines, nickel/silver frets. Rosewood fretboard & bridge, nato neck, body binding.



**SR200SN**.....\$422.95  
Round neck, resonator guitar, Sunburst.  
**SR200S** .....\$440.00  
Square neck available in Sunburst (SB) or Black (BK).



**JR550** .....\$445.00  
Mahogany top, back, sides & neck; hard maple biscuit bridge; 9.5" hand spun, aluminum cone, round neck.

## FLINTHILL



**SFHD100S** Sqr Sunburst .....\$576.37  
Mahogany body and neck. Multi-ply white body binding. Bound rosewood fingerboard with mother-of-pearl dots. 10<sup>1</sup>/<sub>2</sub>" spun aluminum cone. Traditional spider bridge. Chrome-plated hardware.

# LUCIDA



**Classical**  
**LK2** 4/4, 3/4, 1/2, sizes.....**\$86.30**  
 White wood top, back & sides, gold-plated tuning machines. Sizes: 4/4, 3/4, 1/2, 1/4. Overall length: 39.25", 35.8", 33", 29.5".



**Classical**  
**LG510** 4/4, 3/4, 1/2, Sizes.....**\$107.05**  
 White wood top, back & sides, open gear Gotoh tuning machines. Sizes: 4/4, 3/4, 1/2, 1/4. Overall length: 38.6", 36.4", 33.5", 29.5".



**Classical**  
**LG520** .....**\$123.45**  
 Spruce top, white wood back & sides, hard maple fretboard, adjustable truss rod, open gear Gotoh tuning machines.



**Bajo Quinto**  
**LGBQ1E** .....**\$452.10**  
**LGBQ2E** Thinbody .....**452.10**  
 Spruce top, mahogany back, sides and neck, rosewood fretboard, colorful body binding, mosaic rosette, authentic Mexican mariachi strings. Available with 4 Band EQ (**LGBQ1E**) or 4 Band EQ with thin profile body depth (**LGBQ2E**).



**Classical**  
**LK6** .....**\$144.10**  
 Cedar top, mahogany back, sides and neck, rosewood fretboard, gold-plated tuning machines.



**Requinto**  
 Standard spruce top, mahogany back, sides and neck. Nickel-plated tuning machines. Satin finish.  
**LGRQ1** .....**\$121.90**



**Guitarron**  
**LGGR1** .....**\$625.15**  
 The guitarron is a six string acoustic bass. It is considered to be the heartbeat of modern mariachi music because of its soulful tone and romantic energy. It features authentic nylon strings from Mexico and a large round back.



**Vihuela**  
**LGVH1** .....**\$388.65**  
 The beauty and tradition of Mexican guitars comes alive with the Lucida Vihuela. This finely crafted instrument, traditionally used as a rhythm guitar for classical and mariachi music, has a nature rounded back, a halo neck and top, a rosewood nut and fingerboard.



**Bajo Sexto**  
**LGBS1E** .....**\$351.45**  
 Spruce top, mahogany back & sides, rosewood fretboard, 4-band EQ pickup, decorative rosette.

# HOHNER



**Student Size Steel String Acoustic**  
Spruce top, mahogany neck, back & sides, hardwood fretboard, adjustable truss rod 18 frets, in-line tuning machines.

**HW03** .....\$159.00



**Concert Size Acoustic**  
Mahogany back, sides & neck, spruce top, hardwood fretboard, 2-way adjustable truss rod, 18 frets, open tuning machines, scale length: 25½", neck width @ nut: 1⅞".

**HW200** .....\$189.00



**Dreadnought Acoustic**  
Spruce top, mahogany back, sides & neck, hardwood fretboard, 2-way adjustable truss rod, 20 frets, open tuning machines.

**HW220** .....\$209.00



**Full Size Classical**  
Spruce Top • mahogany neck, back & sides • rosewood fingerboard.

**HHHC09** .....\$240.00



**1/4 Size Classical Package**  
Agathis top, back & sides, 18 frets, individual open tuning machines, includes brightly colored outer carton & song-book, scale length: 19".

**HAG250P** .....\$60.00B



**Student Size Classical**  
Spruce top, mahogany back, sides & neck, rosewood fretboard, 18 frets, scale length: 21¾".

**HCO2** .....\$158.00



**Student Size Classical**  
Spruce top, mahogany neck, back & sides, hardwood fingerboard, 18 frets, scale length: 23¾".

**HCO3** .....\$168.00



**Full Size Classical**  
Spruce top, mahogany neck, back & sides, hardwood fretboard, 18 frets.

**HCO6** .....\$178.00

## MARVEL

### Acoustic Guitars



Your favorite, officially licensed Marvel characters adorn this quality junior-size acoustic guitar! Easy to play and stays in tune, these starter guitars are perfect for your little Super Hero. Every guitar is made of real wood with steel strings and comes with Peavey picks and a Marvel guitar strap. Includes a removable headstock cover with matching superhero graphic protecting little fingers from string ends.

**Captain America 1/2 Size Acoustic**  
03011990 .....\$69.99B

**Iron Man 1/2 Size Acoustic**  
03012010 .....\$69.99B

**Wolverine 1/2 Size Acoustic**  
03012030 .....\$69.99B

**Hulk 1/2 Size Acoustic**  
03012000 .....69.99B

**Spider-man 1/2 Size Acoustic**  
03012020 .....69.99B

**Thor 1/2 Size Acoustic**  
03012040 .....69.99B

Basswood body, hardwood neck, basswood fingerboard, 18 frets, chrome gears with ABS keys tuner, 30" length.

# RECORDING KING GUITARS



### Cutaway Electric OM-Style

Cutaway OM-style body, solid sitka spruce top, mahogany back and sides, scalloped spruce forward x-bracing, thin "C" profile mahogany neck, rosewood fretboard, 25.4" scale length, 1 1/16" nut width, bone nut and saddle, die cast tuning machines, **Fishman Presys EQ**, satin finish.

**ROM06CFE4** .....\$651.75



### Dreadnought Body 12 String

Solid sitka spruce top, mahogany back and sides, scalloped spruce forward x-bracing, thin "C" profile mahogany neck, rosewood fretboard, 25.4" scale length, 1 1/16" nut width, bone nut and saddle, die cast tuning machines, black pickguard, gloss finish.

**RD0612** .....\$565.20



### RO-10 000-Style

000-Style body, sitka spruce top, solid mahogany back and sides, scalloped spruce x-bracing, thin "C" profile mahogany neck, 24.9" scale length, 1 3/4" nut width, rosewood fretboard, bone nut and saddle, die cast tuning machines.

**RO10** .....\$659.75



### RD-10 Dreadnought

Dreadnought style body, solid sitka spruce top, solid mahogany back and sides, scalloped spruce forward x-bracing, thin "C" profile mahogany neck with 1 1/16" nut width, 25.4" scale length, rosewood fretboard, bone nut and saddle, die cast tuning machines.

**RD10** .....\$659.75



Dreadnought body, solid sitka spruce top, mahogany back and sides, scalloped spruce forward x-bracing, thin "C" profile mahogany neck, rosewood fretboard, 25.4" scale length, 1 1/16" nut width, bone nut and saddle, die cast tuning machines, black pickguard, gloss finish.

**RD06** .....\$492.30



### Baritone Uke

Mahogany body, geared tuning machines, 18 nickel-plated frets, inlaid position markers, D'Addario nylon strings, includes carrying bag.

**UK210** .....\$119.90

## SAVANNAH

# DIAMOND HEAD UKES



Mahogany body and neck, rosewood fingerboard and bridge with M.O.P. plastic dots, gold-plated guitar-style geared tuners with white plastic buttons.\*

**DU200** Soprano.....\$78.70

**DU200P** Pineapple .....\$78.70



Mahogany body and neck, rosewood fingerboard and bridge with M.O.P. plastic dots, gold-plated guitar-style geared tuners with white plastic buttons.\*

**DU200C** Concert .....\$83.95



Mahogany body and neck, rosewood fingerboard and bridge with M.O.P. plastic dots, gold-plated guitar-style geared tuners with white plastic buttons.\*

**DU200T** Tenor .....\$110.20



Mahogany body and neck, rosewood fingerboard and bridge with M.O.P. plastic dots, gold-plated guitar-style geared tuners with white plastic buttons.\*

**DU200B** Bari.....\$115.45

\* Bag included

## UKES



### Hawaiian Soprano

Mahogany Body, Champion-Style Friction Pegs, 15 Frets, Inlaid Position Markers, Black Nylon Strings, Includes Carrying Bag.

**UK120** .....\$62.05



### Savannah Soprano

White Wood Body, Maple Neck & Fretboard, Friction Peg Tuners, 12 Frets, Inlaid Position Markers, Matte Finish, Includes Carrying Bag.

**SU100** .....\$45.55



### Savannah Soprano

White Wood, G geared Tuners, 12 Frets, Available in Black, Blue, Green, Red, Yellow. Matching Nylon Carrying Bag.

**SU105** .....\$48.15



### Savannah Baritone

White Wood Body, Maple Fretboard, G geared Tuners, 18 Frets, Inlaid Position Markers, Clear Nylon Strings. Includes Carrying Bag.

**SU200** .....\$64.90

## UKES



### Soprano with a Pineapple Shape – Diamond Head

Mahogany body and neck, rosewood fingerboard and bridge with M.O.P. plastic dots, gold-plated guitar-style geared tuners with white plastic buttons. Bag included.

**DU200P** Pineapple .....\$78.70



### Soprano – Diamond Head

Brightly colored ukes nickel-plated guitar-style geared tuners w/bag. Available in: Pink (PI), Blue (B), Red (R), Purple (PU), Orange (O), Lite Blue (LB), White, (W), Green (G), Yellow (Y), Brown (BR), Black (BK)

**DU10** .....\$47.20



### Concert/Spanish

Mahogany Body, Rosewood Fretboard, Champion-Style Friction Pegs, 12 Nickel-Plated Frets, Black Nylon Strings. Includes Carrying Bag.

**UK150** .....\$64.90

**CG070US** Uke bag .....\$11.30



### Baritone

**BU17** Light top .....\$105.85

Mahogany finish, brass frets.

**CG070UB** Bari Uke bag .....\$14.80

## MADISON BANJO UKULELE



### Recording King

Maple neck, single coordinator rod, laminated maple rim, rosewood fretboard, 10 brackets, 20 frets, open-gear tuners, open back, nickel hardware, nylon strings, satin finish.

**RKU25BR** .....\$336.15



### Soprano

Solid mahogany top, mahogany back & sides, mahogany neck, rosewood fretboard & bridge, 13<sup>3/16</sup>" scale length, bone nut & saddle, deluxe adjustable friction tuners, satin finish.

**KU300** .....\$354.65



### Concert

Solid mahogany top, mahogany back & sides, mahogany neck, rosewood fretboard & bridge, 15" scale length, bone nut & saddle, deluxe adjustable friction tuners, satin finish.

**KU320** .....\$354.65



### Tenor

Solid mahogany top, mahogany back & sides, mahogany neck with cut-away and **Fishman "Kula" pickup with LED tuner**, rosewood fretboard & bridge, 17" scale length, bone nut & saddle, deluxe adjustable friction tuners, satin finish.

**KU340CFEU** .....\$328.80

# KOHALA/TIKI SERIES UKULELES



### Soprano Standard Uke

The Tiki series features linden wood construction, vintage-style geared tuning machines, rosewood fingerboard and Tiki bridge, right and left-handed side fret board positioning markers and Aquila Nylgut strings and includes a learn-to-play instruction booklet.

PI (Pink), PU (Purple)

KTSPi .....\$74.00  
KTSPU .....74.00



### Soprano Standard Uke

The Tiki series features linden wood construction, vintage-style geared tuning machines, rosewood fingerboard and Tiki bridge, right and left-handed side fret board positioning markers and Aquila Nylgut strings and includes a learn-to-play instruction booklet.

RD (Red), YE (Yellow)

KTSRD .....\$74.00  
KTSYE .....74.00



### Soprano Standard Uke w/Tuner

The Tiki series features linden wood construction, vintage-style geared tuning machines, rosewood fingerboard and Tiki bridge, right and left-handed side fret board positioning markers and Aquila Nylgut strings and built-in chromatic tuner and includes a learn-to-play instruction booklet.

PI (Pink), PU (Purple)

KTSTPI .....\$94.00  
KTSTPU .....94.00



### Soprano Standard Uke w/Tuner

The Tiki series features linden wood construction, vintage-style geared tuning machines, rosewood fingerboard and Tiki bridge, right and left-handed side fret board positioning markers and Aquila Nylgut strings and built-in chromatic tuner and includes a learn-to-play instruction booklet.

RD (Red), YE (Yellow)

KTSTRD .....\$94.00  
KTSTYE .....94.00



### Concert Uke

The Tiki series features linden wood construction, vintage-style geared tuning machines, rosewood fingerboard and Tiki bridge, right and left-handed side fret board positioning markers and Aquila Nylgut strings and includes a learn-to-play instruction booklet.

PI (Pink), PU (Purple)

KTCPI .....\$94.00  
KTCPU .....94.00



### Concert Uke

The Tiki series features linden wood construction, vintage-style geared tuning machines, rosewood fingerboard and Tiki bridge, right and left-handed side fret board positioning markers and Aquila Nylgut strings and includes a learn-to-play instruction booklet.

RD (Red), YE (Yellow)

KTCRD .....\$94.00  
KTCYE .....94.00



### Concert Uke w/Tuner

The Tiki series features linden wood construction, vintage-style geared tuning machines, rosewood fingerboard and Tiki bridge, right and left-handed side fret board positioning markers and Aquila Nylgut strings and built-in chromatic tuner and includes a learn-to-play instruction booklet.

PI (Pink), PU (Purple)

KTCTPI .....\$115.00  
KTCTPU .....115.00



### Concert Uke w/Tuner

The Tiki series features linden wood construction, vintage-style geared tuning machines, rosewood fingerboard and Tiki bridge, right and left-handed side fret board positioning markers and Aquila Nylgut strings and built-in chromatic tuner and includes a learn-to-play instruction booklet.

RD (Red), YE (Yellow)

KTCTRD .....\$115.00  
KTCTYE .....115.00

The TIKIPOP is a wall display that is mountable on either slat wall or pegboard and holds four Tiki Series ukes of any size.  
TIKIPOP.....\$50.00

# LAG UKULELES



### Soprano Uke

Tramontane headstock w/ivory Lag logo, nickel machine heads w/ivory buttons, solid rosewood fretboard & bridge, 345mm/soprano scale length, nickel frets, mahogany top, back & sides, Lag ukulele 44 rosette, French satin finish, aquila strings, with gigbag with printed logo.

LAGU44S .....\$129.00B



### Concert Uke

Tramontane headstock w/ivory Lag logo, nickel machine heads w/ivory buttons, solid rosewood fretboard & bridge, 380mm/concert scale length, nickel frets, mahogany top, back & sides, Lag ukulele 44 rosette, French satin finish, aquila strings, with gigbag with printed logo.

LAGU44C .....\$140.00B



### Soprano Standard Uke

Tramontane headstock w/black Lag logo, satin black small die cast machine heads w/oval buttons, solid rosewood fretboard & bridge, 345mm/soprano scale length, nickel frets, mahogany top, back & sides, black & ivory bindings, Lag ukulele 77 rosette, French satin finish, D'Addario Nyltech strings, with gigbag with printed logo.

LAGU77S .....\$194.00B



### Concert Uke

Tramontane headstock w/black Lag logo, satin black small die cast machine heads w/oval buttons, solid rosewood fretboard & bridge, 380mm/concert scale length, nickel frets, mahogany top, back & sides, black & ivory bindings, Lag ukulele 77 rosette, French satin finish, D'Addario Nyltech strings, with gigbag with printed logo.

LAGU77C .....\$224.00B

# KOHALA



**Standard Uke**  
Standard size, mahogany top, mahogany back/sides, rosewood fretboard & bridge, 12 frets, geared machines.  
AKSL .....\$92.00



**Standard Uke**  
Standard size, mahogany top, mahogany back/sides, rosewood fretboard, 12 frets, geared machines, white binding.  
AKS .....\$115.00



**Tenor Uke**  
Tenor size, mahogany top, mahogany back/sides, rosewood fretboard, 18 frets, die-cast machines, white binding.  
AKT .....\$175.00



**Baritone Uke (Kanipapila)**  
Baritone uke, mahogany top, mahogany back/sides, rosewood fretboard, 18 frets, die-cast machines, white binding.  
KPB .....\$175.00



**Pineapple Uke**  
Pineapple size, mahogany top, mahogany back/sides, rosewood fretboard, 12 frets, geared machines, white binding.  
AKSP .....\$115.00



**Concert Uke**  
Concert size, mahogany top, mahogany back & sides, rosewood fretboard, passive under saddle electronics, 18 frets, chrome die-cast machines, white binding.  
AKCAE .....\$220.00



**Tenor Uke**  
Tenor size, mahogany top, mahogany back & sides, rosewood fretboard, passive under saddle electronics, 18 frets, chrome die-cast machines, white binding.  
AKTAE .....\$260.00



**Concert Uke**  
Concert size, mahogany top, mahogany back/sides, rosewood fretboard, 18 frets, die-cast machines, white binding.  
AKC .....\$155.00

## GUARDIAN HARDSHELL UKULELE CASES



CG020US Soprano Uke, 5 ply .....\$57.60  
CG020UC Concert Uke, 5 ply .....72.40  
CG020UT Tenor Uke, 5 ply .....74.30  
CG020UB Bari Uke, 5 ply .....73.20



## HOHNER UKE CASES/BAGS



UCB Baritone, Featherweight Case .....\$59.00  
UCC Concert, Featherweight Case .....59.00  
UCS Standard, Featherweight Case .....59.00  
UCT Tenor, Featherweight Case .....59.00  
HSS611 Standard Bag, w/Shoulder Strap .....22.00  
HSS612 Concert Bag w/Shoulder Strap .....22.00  
HSS613 Tenor Bag w/Shoulder Strap .....24.00  
HSS614 Baritone Bag w/Shoulder Strap .....24.00

# RIPTIDE UKES



Soprano, laminated mahogany top, back and sides, (natural satin finish).  
**US5NS .....\$141.00**



Concert, laminated mahogany top, back and sides, (natural satin finish).  
**UC5NS.....\$156.00**



A/E concert, laminated mahogany top, back and sides, (natural satin finish).  
**EUC5NS .....\$270.00**



Tenor, laminated mahogany top, back and sides, (natural satin finish).  
**UT5NS .....\$199.00**



Baritone, laminated mahogany top, back and sides, (natural satin finish).  
**UB5NS .....\$227.00**



A/E concert, solid mahogany top, laminated mahogany back and sides, (natural gloss finish), abalone inlay/binding.  
**EUC5NG .....\$427.00**



Concert, laminated mahogany top, back and sides, (gloss butter cream finish), abalone inlay/binding.  
**UC5BC.....\$313.00**



Soprano, solid spruce top, laminated rosewood back and sides, (gloss natural finish), abalone inlay/binding.  
**US2N .....\$270.00**



Concert, solid spruce top, laminated rosewood back and sides, (gloss natural finish), abalone inlay/binding.  
**UC2N .....\$284.00**



Concert, solid spruce top, laminated rosewood back and sides, (gloss cabo sunset finish), abalone inlay/binding.  
**UC2CS .....\$284.00**



A/E concert, solid spruce top, laminated rosewood back and sides (gloss natural finish), abalone inlay/binding.  
**EUC2N .....\$384.00**



Tenor, solid spruce top, laminated rosewood back and sides (gloss natural finish), abalone inlay/binding.  
**UT2N .....\$327.00**



# RIPTIDE UKES



A/E tenor, solid spruce top, laminated rosewood back and sides, (gloss natural finish), abalone inlay/binding.  
**EUT2N** .....\$399.00



A/E tenor, with cutaway, solid spruce top, laminated rosewood back and sides, (gloss vintage natural finish), abalone inlay/binding.  
**ECUT2V** .....\$469.00



Baritone, solid spruce top, laminated rosewood back and sides, (gloss natural finish), abalone inlay/binding.  
**UB2N** .....\$341.00



A/E baritone, solid spruce top, laminated rosewood back and sides, (gloss natural finish), abalone inlay/binding.  
**EUB2N** .....\$427.00



A/E tenor, w/cutaway, laminated mahogany top, solid mahogany back and sides, abalone inlay/binding.  
**ECUT5BK Black** .....\$427.00



A/E tenor, w/cutaway, solid spruce top, laminated rosewood back and sides, (gloss cabo sunset finish), abalone inlay/binding.  
**ECUT2CS** .....\$469.00

[www.bouldercreekguitars.com](http://www.bouldercreekguitars.com)

## JUST IN CASE

### CASE HARDWARE



**CP10**



**CP15**



**CP20**



**CP32**



**CP66**

<b>CP10</b>	Small Drawbolt, Brass .....	\$ 4.95
<b>CP12</b>	Small Drawbolt, Deluxe, Brass .....	5.95
<b>CP15</b>	Large Drawbolt, Brass .....	7.00
<b>CP17</b>	Large Drawbolt, Deluxe, Brass .....	7.95
<b>CP20</b>	Small Lock Deluxe, Brass .....	7.95
<b>CP22</b>	Large Lock Deluxe, Brass .....	11.95
<b>CP30</b>	Rubber Bumpers, Four .....	5.95
<b>CP32</b>	Steel Corners, Four Chrome.....	7.00
<b>CP40</b>	Large Hinge Chrome .....	5.85

<b>CP60</b>	Molded Handle .....	\$11.95
<b>CP62</b>	Center Bar Handle .....	13.00
<b>CP64</b>	Leather Emergency Handle, Brown .....	22.95
<b>CP66</b>	Leather Emergency Handle, Black .....	22.95
<b>CP68</b>	Leather Buckle Handle, Brown .....	25.95
<b>CP70</b>	Leather Buckle Handle, Black.....	25.95

### MOUNTING HARDWARE

<b>CP45</b>	Wood Screws, Four .....	\$4.00
<b>CP46</b>	Chrome Split Rivets, Four.....	4.00
<b>CP47</b>	Brass Split Rivets, Four .....	4.00

## CASE HANDLES



**5596**

<b>CP64</b>	Emergency Handle, Brown .....	\$22.95
<b>CP66</b>	Emergency Handle, Black .....	22.95
<b>5564</b>	Emergency Buckle Black .....	21.95
<b>5596</b>	Post Type Buckle Handle, Black.....	25.95
<b>CH912</b>	12 piece handle replacement kit ....	48.00

## APPLECREEK DULCIMERS



**ACD100**  
Teardrop shape .....\$149.50  
Natural laminated spruce top.  
Stained laminated spruce back and  
sides. Solid maple neck and finger-  
board. Total length: 31", body depth:  
1 7/8", scale length: 24".

**AC50** .....\$29.50  
Padded carry bag for ACD100



**ACD150**  
Hourglass .....\$219.50  
Natural laminated spruce top.  
Stained laminated spruce back and  
sides. Solid maple neck and finger-  
board. Total length: 37", body depth:  
2", scale length: 27", lower bout:  
16 1/2", upper bout: 13 1/4".

**AC75**  
Case (ACD 150, 200) .....\$79.50



**ACD200 - PRO MODEL**  
Cherry Hourglass .....\$289.50  
Solid cherry back, sides and neck.  
Total length: 37", body depth: 2",  
scale length: 27", lower bout: 16 1/2",  
upper bout: 13 1/4".

## DULCIMER

JOHNSON



Oval Shaped w/case.  
**FI220** .....\$185.50  
Nato top and neck, mahogany body,  
scalloped strumming area, 15-fret  
fingerboard, scale length: 26 1/2", de-  
corative heart-shaped sound holes.  
Includes featherweight case.

## JOHNSON PLAYER PACKS



**Acoustic**  
Includes acoustic guitar (**JG-610**)  
Cordura nylon bag, pitch pipe, peg  
winder, guitar strap, 6 celluloid  
picks.  
**JGKITN** Natural .....\$219.05  
**JGKITBL** Blue .....\$219.05



**Parlor**  
Includes acoustic guitar (**JG-420**),  
padded Cordura gig bag, pitch pipe,  
peg winder, guitar strap, 6 celluloid  
picks.  
**JGKITW** .....\$214.30

## TRAVELERS GUITARS

APPLECREEK



**ACG10** Acoustic .....\$139.50  
**ACG10E** Acous/Elec.....\$159.50  
**ACB15** Carry Bag .....\$22.50  
Beautifully mahogany stained back  
and sides, laminated spruce tops,  
enclosed tuning gears. Total length:  
33", width: 7 3/4", depth 2 1/2", nut to  
saddle length: 25", nut 1 5/8", 23 frets.  
**ACG20** 3/4 Size Parlor .....\$249.50  
**ACB20** Bag for ACG20 .....\$29.50  
**ACG20K** w/Bag .....\$279.50

JOHNSON



**JGTR2** w/Bag ..\$142.95 Small scale  
design; spruce top; mahogany back,  
sides & neck; nickel/  
silver frets; scale length 24 3/4".

## RECORDING KING LAP STEEL GUITARS



**Lap Steel Guitar**  
**RG31NA** .....\$260.15  
Natural mahogany satin finish



**RG32SN** .....\$267.55  
Gloss sunburst finish

The Recording King Lap Steel is simple but classic. One volume, one tone, and one hot P-90 give this guitar the historic lap steel sound. Solid mahogany body, Pearlloid fretboard, metal button tuning machines, single P-90 pickup, volume and tone controls, string-through-body design.  
**CG090LS** Lapsteel Bag .....\$35.15

## CHROMAHARPS



**CAP2515** 15 Chord .....\$687.10  
**CAP2521** 21 Chord .....\$747.10

### ACCESSORIES

**P204** Spring .....\$ .75  
**GCAH** Case for CAP2515, CAP2521 .....\$73.70  
**BWAHK** Tuning Key .....\$10.95  
**S100** Chromaharp String Set .....\$120.00  
**RB1508** Bag .....\$30.00

# CASES & BAGS

## CHIPBOARD CASES



MODEL	STYLE	LENGTH	UPPER WIDTH	LOWER WIDTH	DEPTH	LIST
GC149	3/4, 3100.....	37.625	10.875	12.625	4.750	\$69.45
GC150	Student, 3101 .....	39.375	10.875	14.000	4.750	69.45
GC151	Concert, 3102 .....	41.125	11.750	15.000	5.000	69.45
GC152	Classic, 3248 .....	41.375	11.625	15.625	5.250	69.45
GC153	Gr. Concert, 3250.....	41.875	12.125	16.125	5.500	69.45
GC154	Dread., 3105 .....	42.500	12.875	16.500	5.500	69.45
GC155	Jumbo, 3240 .....	42.750	12.625	16.500	6.000	69.45
GC157	12 String, 3106.....	43.750	12.750	16.875	5.750	73.70
GC3406	Solid S Style, Elec. ....	42.625	11.750	13.500	3.250	73.70
GC673	Bass, 3116 .....	48.000	13.375	15.000	3.500	78.10
GC135	Banjo, Large Resonator, 3119.....					69.45
GCKM	Mandolin, Arch Top, 3120 .....					69.45
GCBU	Bari Uke, 3121 .....					73.70
JP523	Case Humidifier, John Pearse .....					29.95B

Quantity Pricing Available

## TKL GUITAR BAGS



B5100	Black Belt Classical.....	\$15.00
B5115	Black Belt 6/12 String .....	15.00
B5130	Black Belt Electric .....	15.00
B5136	Black Belt P-Bass.....	15.00
B5150	Black Belt 1/2 Guitar .....	15.00
B5175	Black Belt 3/4 Guitar .....	15.00
B4650	Traditional 1/2 Guitar .....	37.70
B4651	Traditional A/F Mandolin .....	37.70
B4675	Traditional 3/4 Guitar .....	37.70
B4629	Lap Steel .....	37.70
B4630	Traditional Electric .....	37.70
B4636	Bass .....	37.70
B4600	Classical.....	37.70
B4615	Dreadnaught .....	37.70
B4700	Deluxe Classical .....	60.40
B4715	Deluxe Acoustic .....	60.40
B4720	Deluxe Jumbo .....	60.40
B4730	Deluxe Electric .....	60.40
B4736	Deluxe J/P Bass .....	60.40
B4755	Deluxe 335 .....	60.40
B5200	High Definition Classical.....	60.40
B5215	High Definition Dread 6/12.....	60.40
B5230	High Definition Electric .....	60.40
B5236	High Definition J/P Bass .....	60.40
B5300	High Definition Classical.....	75.55
B5315	High Definition Dread 6/12.....	75.55
B5330	High Definition Electric Bag .....	75.55
B5336	High Definition J/P Bass Bag .....	75.55
B5415	High Definition Dread 6/12.....	113.35
B5430	High Definition Electric .....	113.35
B5436	High Definition J/P Bass .....	113.35

www.tkl.com

## GIG BAGS



SC260	Dreadnaught (Nylon) Superior.....	\$62.20
SC262	Classic (Nylon) Superior .....	62.20
SC266	Electric (Nylon) Superior.....	62.20
SC267T	Tenor Banjo O/B - Travel Guitar.....	47.20
SC267	Banjo w/o Resonator (Nylon) Superior.....	50.00
SC268	Bass (Nylon) Superior.....	62.20
SC269	Banjo w/ Resonator (Nylon) Superior .....	62.20
SCG180	(Nylon) Dreadnaught.....	39.85
SCG182	(Nylon) Classic.....	39.85
SCG186	(Nylon) Electric.....	39.85
SCG188	(Nylon) Bass .....	39.85
44CG180	4/4 Guitar (Nylon) Golden Gate .....	39.85
34CG180	3/4 Guitar (Nylon) Golden Gate .....	42.15
SCG160	Dreadnaught (Nylon) Golden Gate.....	36.60
SCG162	Classic (Nylon) Golden Gate .....	36.60
SCG166	Electric (Nylon) Golden Gate.....	36.60
SCG168	Bass (Nylon) Golden Gate.....	36.60
CG090EM	3/4 Electric (Nylon) Johnson.....	31.45
CG090B	Bass.....	34.45
CG090D	Dreadnaught Johnson (Nylon) .....	34.45
CG100D	Dreadnaught (Nylon) Johnson.....	38.30
CG100C	Classic.....	38.30
CG100B	Bass.....	38.30
CG100E	Electric.....	38.30
CG100J	Banjo .....	38.10
CG400AB	Acoustic Bass 5" Deep.....	56.15
PM615	Banjo (Cordura) .....	37.80
SC3770	Mandolin (Nylon) .....	38.85

## ECONOMY SERIES

GB060	1/2 Acoustic Guitar Bag (Vinyl) .....	\$23.50
GB160	Standard .....	23.50
SCG050	Dreadnaught, Nylon .....	24.40
SCG052	Classic, Nylon .....	24.40
SCG056	Universal Electric, Nylon .....	24.40
SCG058	Universal Bass, Nylon .....	24.40
CG070US	Ukulele .....	11.55
CG070UB	Bariuke .....	15.00
CG075B	Bass .....	15.20
CG075C	Classical, Specify 4/4, 3/4 or 1/2 Size .....	16.65
CG075D	Dreadnaught, Specify 4/4, 3/4 or 1/2 Size.....	16.65
CG075E	Electric .....	14.25
CG085B	Bass.....	17.60
CG085C	Classical .....	18.55
CG085D	Dreadnaught, Specify 4/4, 3/4 or 1/2 Size.....	18.55
CG085J	Banjo .....	17.30
CG085E	Electric .....	16.15

## TKL ZERO GRAVITY CASES



TKL6115	Dreadnaught .....	132.30
TKL6130	Electric .....	132.30
TKL6136	Bass .....	151.75

www.tkl.com

## KACES WEIGHTLESS CASES



KPFC18	Classic (Poly Foam).....	\$157.45
KPFA20	Dreadnaught (Poly Foam) .....	157.45
KPFE07	Electric (Poly Foam) .....	157.45

www.aceproducts.com

Prices Subject to Change Without Notice

## PEAVEY®



00479950



00480400

### BAGS & CASES

Deluxe acoustic bag with front accessory pouch. Handgrip and adjustable shoulder strap. Embroidered Peavey logo.

<b>00479950</b>	Electric Guitar Bag .....	<b>\$25.99</b>
<b>00480400</b>	Deluxe Acoustic Bag .....	<b>\$37.49</b>

Quality nylon exterior lite cases. Convenient large, zippered accessory pouch. Plush, Styrofoam-formed interior. Back strap equipped with metal clasps. Includes Peavey luggage tag for easy identification.

<b>00454110</b>	Acoustic Lite Case .....	<b>\$99.99</b>
<b>00454120</b>	Electric Lite Case, Rectangular.....	<b>101.29</b>
<b>00496970</b>	Bass Lite Case, Rectangular .....	<b>109.99</b>

## ON STAGE

### Hardshell Guitar Cases

All cases are constructed from plywood w/vinyl covering with an interior that is custom molded to keep the guitar stable with full neck support. The interior also features a soft plush lining and an accessories compartment, perfect for picks and capos. Gold-plated hardware.

<b>GCA5000B</b>	Acoustic Guitar Case .....	<b>\$159.99</b>
	Sized to fit most dreadnought and 12 string guitars	
<b>GCA5500B</b>	Semi-Acoustic Guitar Case .....	<b>159.99</b>
	Sized to fit most semi-acoustic and dreadnought guitars	
<b>GCA5600B</b>	Jumbo Acoustic Guitar Case.....	<b>209.99</b>
	Sized to fit most jumbo acoustic guitars	
<b>GCC5000B</b>	Classical Guitar Case .....	<b>179.99</b>
	Sized to fit most classical and Spanish style guitars	

## ON STAGE

### Gig Bags

#### GUITAR GIG BAGS

They are made from a rugged, water repellent, easy to clean 600-D nylon material. Features include interior lining, heavy-duty 2-pull zipper, and a front zip pocket to carry pics or replacement strings. Use either th two carrying handles or the removable padded backpack-style straps.

<b>GBE4550</b>	Electric Guitar Gig Bag.....	<b>\$37.99</b>
<b>GBA4550</b>	Acoustic Guitar Gig Bag.....	<b>37.99</b>
<b>GBB4550</b>	Bass Guitar Gig Bag .....	<b>37.99</b>
<b>GBC4550</b>	Classical Guitar Gig Bag .....	<b>37.99</b>

#### DELUXE GUITAR GIG BAGS

The series includes four models; all models combine the protection of a 1/2" foam-lined interior with the portability of a canvas bag. Features include 2 exterior accessories pockets with a leather accent strip; heavy-duty 2-pull zippers, which allow the bag to be unzipped lengthwise; 1 side carry handle with padded leather; 1 top carry handle with padded leather; adjustable back-pack straps; an ID tag; and 2 bag hangers.

<b>GBE4660</b>	Electric Guitar Gig Bag .....	<b>\$44.99</b>
<b>GBA4660</b>	Acoustic Guitar Gig Bag .....	<b>44.99</b>
<b>GBB4660</b>	Bass Guitar Gig Bag .....	<b>44.99</b>
<b>GBC4660</b>	Classical Guitar Gig Bag .....	<b>44.99</b>

#### UKULELE GIG BAGS

A new line of durable and affordable gig bags designed to hold and transport your new uke! These lightweight bags were designed for easier mobility; bag can be carried using the padded carry handle or adjustable/removable back-pack straps. All bags feature a 7mm foamed-lined interior, 2 exterior accessories pockets and a top bag hanger.

<b>GBU4103</b>	Soprano Ukulele Bag .....	<b>\$39.99</b>
<b>GBU4104</b>	Concert Ukulele Bag .....	<b>39.99</b>
<b>GBU4102</b>	Tenor Ukulele Bag .....	<b>39.99</b>
<b>GBU4101</b>	Baritone Ukulele Bag.....	<b>39.99</b>

## PROFILE GIG BAGS



PREB906BL

#### 5mm Foam Padding

<b>B05TX</b>	Bass .....	<b>\$35.99</b>
<b>CF05TX</b>	Classic .....	<b>35.99</b>
<b>W05TX</b>	Dreadnought .....	<b>35.99</b>
<b>G05TX</b>	Electric Guitar .....	<b>35.99</b>

#### 30mm Foam Padding

<b>PRDB906KA</b>	Dreadnought.....	<b>\$69.99B</b>
<b>PRBB906GR</b>	Bass .....	<b>69.99B</b>
<b>PREB906BL</b>	Electric Guitar .....	<b>69.99B</b>
<b>PRCB906RD</b>	Classic .....	<b>69.99B</b>
<b>PRXB906BK</b>	Large Body Electric Guitar .....	<b>69.99B</b>

## KACES GIG BAGS



KBBU

<b>KBBU</b>	Pro Universal Banjo .....	<b>\$69.25</b>
<b>KUMB</b>	Pro Universal Mandolin .....	<b>54.45</b>
<b>KXA3</b>	Razor Express Dreadnaught .....	<b>34.65</b>
<b>KXC4</b>	Razor Express Classical .....	<b>32.15</b>
<b>KXE1</b>	Razor Express Electric .....	<b>32.15</b>
<b>KXB2</b>	Razor Express Bass.....	<b>34.65</b>
<b>KGB20</b>	Acoustic Guitar .....	<b>65.30</b>
<b>KREBK2</b>	Electric, Pointy Guitar 48" x 18" .....	<b>93.70</b>
<b>KGBXC</b>	Razor Multipocket Pro Classical.....	<b>69.25</b>
<b>KUKS3</b>	Soprano Uke .....	<b>27.50</b>
<b>KUKT2</b>	Tenor Uke .....	<b>46.40</b>

[www.aceproducts.com](http://www.aceproducts.com)

## LEVY'S GIG BAGS



EM8

<b>EM8</b>	600 denier polyester economy <b>bass guitar</b> gig bag with 1/2" foam padding and headliner lining. Bag features accessory pocket and shoulder strap. 47" x 16" at lower bout .....	<b>\$35.95</b>
<b>EM7</b>	600 denier polyester economy <b>electric guitar</b> gig bag with 1/2" foam padding and headliner lining. Bag features accessory pocket and shoulder strap. 40" x 15" at lower bout .....	<b>32.00</b>
<b>EM20</b>	600 denier polyester economy <b>acoustic guitar</b> gig bag with 1/2" foam padding and headliner lining. Bag features accessory pocket and shoulder strap. 43" x 16" .....	<b>44.60</b>
<b>EM20C</b>	600 denier polyester economy <b>classical guitar</b> gig bag with 1/2" foam padding and headliner lining. Bag features accessory pocket and shoulder strap. 40" x 15" .....	<b>42.35</b>
<b>EM7S</b>	For <b>electric guitar</b> . 40" x 15" at lower bout .....	<b>59.65</b>
<b>EM7P</b>	600 denier polyester <b>electric guitar</b> gig bag with 3/4" foam padding and headliner lining. With accessory pocket and twin shoulder strap. 40" x 16" at lower bout .....	<b>39.40</b>
<b>EM8P</b>	Same as EM7P for <b>electric bass guitar</b> . 49" x 16" at lower bout.....	<b>53.80</b>
<b>EM20P</b>	Same as EM7P for <b>acoustic guitar</b> . 42" x 16" at lower bout.....	<b>47.00</b>
<b>CMUB</b>	Polyester ukulele bag for <b>baritone ukulele</b> . Features foam padding, plush lining, back-pack shoulder straps, and pouch pocket. Available in black only. Interior dimensions 31 1/4" x 11 1/4" .....	<b>45.45</b>
<b>CMUT</b>	Same as CMUB but for <b>tenor ukulele</b> . Interior dimensions 27 1/2" x 9 1/2" .....	<b>39.90</b>
<b>CMUC</b>	Same as CMUB but for <b>concert ukulele</b> . Interior dimensions 25" x 9" .....	<b>33.54</b>
<b>CMUS</b>	Same as CMUB but for <b>soprano ukulele</b> . Interior dimensions 22" x 7 1/2" .....	<b>31.25</b>

# CASES

## TKL HARD SHELL CASES



GC8836

### RECTANGULAR

<b>GC8930TW</b>	Solid Body Guitar, Tweed .....	<b>\$358.65</b>
<b>GC8836TW</b>	1-2 PU Bass, Tweed .....	<b>249.95</b>
<b>GC8736</b>	Solid Body Bass, Molded Plastic .....	<b>251.85</b>
<b>GC8830</b>	Solid Body Guitar .....	<b>197.70</b>
<b>GC8835</b>	1 Pick-up Bass .....	<b>202.00</b>
<b>GC8836</b>	1-2 Pick-up Bass .....	<b>202.00</b>
<b>O900</b>	Fender Strat, Tele Molded Plastic .....	<b>159.40B</b>
<b>GC7830</b>	Electric.....	<b>163.35</b>
<b>GC7832</b>	Ex Style .....	<b>194.10</b>
<b>GC7836</b>	J or P Bass .....	<b>171.90</b>



### SHAPED

<b>GC7875</b>	Standard, Parlor .....	<b>\$163.35</b>
<b>GC652</b>	Classic.....41.000 12.000 15.750 5.000.....	<b>189.10</b>
<b>TKL9100</b>	Elite Classic .....	<b>287.90</b>
<b>GC8805</b>	Grand Concert .....	<b>189.10</b>
<b>GC654</b>	Dreadnaught.....44.500 12.750 16.500 5.750.....	<b>189.10</b>
<b>SC1502F</b>	Classic Resonator (Saga).....	<b>110.25</b>
<b>GC7825</b>	Single Cutaway Electric .....	<b>163.15</b>
<b>GC8820</b>	Jumbo, Arched Top.....	<b>202.00</b>
<b>GC8825TW</b>	Single Cutaway Elec. Tweed .....	<b>244.95</b>
<b>HS6145</b>	Semi Acoustic.....43.000 12.500 16.500 4.375.....	<b>202.00</b>
<b>GC7800</b>	Classic .....	<b>163.15</b>
<b>GC7805</b>	Grand Concert .....	<b>163.15</b>
<b>GC7815</b>	Dreadnaught .....	<b>163.15</b>
<b>GC7855</b>	Semi Acoustic .....	<b>171.90</b>
<b>GC8801</b>	Arch Top Resonator – Square Necks.....	<b>189.10</b>
<b>GC8825</b>	Arch Top Single Cutaway .....	<b>197.70</b>
<b>GC7826</b>	Double Cutaway Case .....	<b>163.35</b>
<b>GC7868</b>	Acoustic Bass .....	<b>210.60</b>
<b>GC8802</b>	Arch Top Round Neck Resonator .....	<b>189.10</b>

## TKL HARD SHELL BANJO/MANDOLIN CASES



<b>GC2960</b>	Banjo, Large Resonator .....	<b>\$171.70</b>
<b>GC7843</b>	Tenor Banjo .....	<b>171.70</b>
<b>GC8852</b>	F Style Mandolin .....	<b>171.70</b>
<b>GC8952</b>	F Style Mandolin, A/T Oblong.....	<b>283.65</b>
<b>GC8851</b>	A Style Mandolin .....	<b>171.90</b>

## GUARDIAN HARDSHELL CASES



CG020C

<b>CG044D</b>	Dreadnaught, Vintage, 7 ply .....	<b>\$163.45</b>
<b>CG044VB</b>	Viola Bass, Vintage, 7 ply .....	<b>155.25</b>
<b>CG018D</b>	Arch Top Dreadnaught, 3 ply.....	<b>105.80</b>
<b>CG018C</b>	Arch Top Classic, 3 ply .....	<b>102.35</b>
<b>CG018E</b>	Electric, 3 ply .....	<b>97.60</b>
<b>CG018B</b>	Bass, 3 ply .....	<b>104.85</b>
<b>CG018J</b>	Arch Top Resonator Banjo, 3 ply .....	<b>98.25</b>
<b>CG020C</b>	Classic, 5 ply .....	<b>108.65</b>
<b>CG020CT</b>	Classic, Thin Line, 5 ply .....	<b>116.20</b>
<b>CG022C</b>	Classic, Arch Top, 5 ply .....	<b>121.85</b>
<b>CG022D</b>	Dreadnaught, 5 ply .....	<b>126.75</b>
<b>CG022DT</b>	Arch Top, Thin Body, Acoustic, 5 ply .....	<b>123.75</b>
<b>CG022E</b>	Electric, 5 ply .....	<b>111.10</b>
<b>CG022GJ</b>	Gypsy Jazz, 5 ply, Arch Top .....	<b>127.85</b>
<b>CG022P</b>	Parlor, Arch Top, 5 ply .....	<b>122.80</b>
<b>CG022SGG</b>	Deluxe, Double Cutaway, Arch Top, 5 ply .....	<b>114.30</b>
<b>CG020D</b>	Dreadnaught, 5 ply .....	<b>112.75</b>
<b>CG022000</b>	Deluxe OOO Arch Top .....	<b>123.45</b>
<b>CG020000</b>	OOO, 5 ply.....	<b>109.25</b>
<b>CG020E</b>	Electric, 5 ply.....	<b>103.60</b>
<b>CG020B</b>	Bass, 5 ply .....	<b>111.80</b>
<b>CG020DJ</b>	Jumbo, 5 ply .....	<b>115.55</b>
<b>CG020HS</b>	Semi Acoustic, 5 ply .....	<b>109.25</b>
<b>CG020JO</b>	Open Back Banjo.....	<b>125.65</b>
<b>CG020LP</b>	Single Cutaway, 5 ply .....	<b>109.10</b>
<b>CG020V</b>	V Styles, 5 ply .....	<b>174.45</b>
<b>CG020VB</b>	Viola Bass, 5 ply.....	<b>108.30</b>
<b>CG020X</b>	Ex Style, 5 ply .....	<b>157.95</b>
<b>CG022BA</b>	Acoustic Bass, Arch Top, 5 ply.....	<b>140.15</b>
<b>CG022SQ</b>	Square Neck Resonator, Arch Top, 5 ply .....	<b>125.65</b>
<b>CG035D</b>	Dreadnaught, Tweed, 5 ply .....	<b>159.35</b>
<b>CG035E</b>	Electric, Tweed, 5 ply .....	<b>160.00</b>
<b>CG035B</b>	Bass, Tweed, 5 ply .....	<b>175.15</b>
<b>CG041D</b>	Dreadnaught, Molded Plastic .....	<b>139.85</b>
<b>CG041E</b>	Electric, Molded Plastic .....	<b>135.10</b>
<b>CG010C</b>	Classic Featherweight .....	<b>97.45</b>
<b>CG010D</b>	Dreadnaught, Featherweight .....	<b>105.75</b>
<b>CG010E</b>	Electric Featherweight .....	<b>96.60</b>
<b>CG010B</b>	Bass Featherweight .....	<b>104.55</b>
<b>CG010DJ</b>	Jumbo, Featherweight .....	<b>115.80</b>
<b>CG010S</b>	Electric Shaped Featherweight .....	<b>109.60</b>
<b>GLF104</b>	Case Freshener, 4 oz. ....	<b>10.20</b>

## GUARDIAN BANJO/MANDOLIN CASES



<b>CG020J</b>	Banjo, 5 ply .....	<b>\$104.55</b>
<b>CG020MA</b>	A Style Mandolin, 5 ply .....	<b>78.80</b>
<b>CG020MF</b>	F Style Mandolin, 5 ply.....	<b>84.15</b>
<b>CG035MA</b>	A Style Mandolin, Hardshell Tweed .....	<b>107.40</b>
<b>CG040MF</b>	Mandolin, Fit All, Molded Plastic .....	<b>114.70</b>
<b>CG010J</b>	Banjo w/Reso, Featherweight .....	<b>90.50</b>
<b>CG010MF</b>	Mandolin, F Style, Featherweight .....	<b>74.10</b>
<b>CG010MA</b>	Mandolin, Featherweight, A Style .....	<b>65.35</b>
<b>CG010JO</b>	Banjo, No Resonator, Featherweight.....	<b>91.35</b>
<b>CG010US</b>	Uke, Featherweight .....	<b>52.25</b>
<b>CG010UB</b>	Bari Uke, Featherweight.....	<b>52.25</b>

# CASES & BAGS

## SKB



### HARD SHELL

<b>SKB18</b>	Dreadnaught.....	<b>\$259.99</b>
<b>SKB20</b>	Jumbo.....	<b>295.99</b>
<b>SKB30</b>	Classic.....	<b>254.99</b>
<b>SKB000</b>	000.....	<b>254.99</b>
<b>SKB50</b>	Banjo Univers A1.....	<b>212.99</b>
<b>SKB80A</b>	A Mandolin.....	<b>160.99</b>
<b>SKB80F</b>	F Mandolin.....	<b>160.99</b>
<b>SKB56</b>	Electric, Single Cutaway.....	<b>228.99</b>
<b>SKB58</b>	V Style.....	<b>290.99</b>
<b>SKB63</b>	Ex Style.....	<b>290.99</b>
<b>SKB66</b>	Electric, S Style.....	<b>238.99</b>
<b>SKB44</b>	Bass.....	<b>264.99</b>
<b>SKBFS6</b>	Shaped Strat/Tele (Leftys Also Fit).....	<b>238.99</b>
<b>SKBFB4</b>	Shaped J/P Bass.....	<b>264.99</b>
<b>SKB300</b>	Baby Taylor.....	<b>150.99</b>
<b>SKB35</b>	Electric, Thin Body.....	<b>235.99</b>
<b>SKB3</b>	Thin-line Acoustic-Electric.....	<b>176.99</b>
<b>SKB4</b>	Electric Bass.....	<b>181.99</b>
<b>SKB6</b>	Electric Guitar.....	<b>165.99</b>
<b>SKB8</b>	Acoustic Cases.....	<b>181.99</b>
<b>SKB16</b>	Acoustic Shallow Roundback Shaped.....	<b>259.99</b>
<b>SKB17</b>	Acoustic Deep Roundback Shaped.....	<b>259.99</b>
<b>SKB52</b>	Universal 6-string Banjo Case.....	<b>212.99</b>
<b>SKB62</b>	Jaguar/Jazzmaster Type Shaped.....	<b>238.99</b>



### GUITAR SOFT CASES

<b>SKBSC30</b>	Thin-line AE/Classic.....	<b>\$147.99</b>
<b>SKBSC44</b>	Electric Bass.....	<b>145.99</b>
<b>SKBSC66</b>	Electric Guitar.....	<b>154.99</b>
<b>SKBSC18</b>	Acoustic Case.....	<b>147.99</b>
<b>SKBSC56</b>	Single Cutaway.....	<b>141.99</b>
<b>SKBSC58</b>	V Style.....	<b>194.99</b>
<b>SKBSC63</b>	Ex Style.....	<b>194.99</b>
<b>SKBSC300</b>	Baby Taylor.....	<b>125.99</b>
<b>SKBSCFB4</b>	Universal Electric Bass.....	<b>160.99</b>
<b>SKBSCFS6</b>	Universal Electric Guitar.....	<b>150.99</b>

### INJECTION MOLDED GUITAR CASES

<b>3I421718</b>	Injection Molded Dreadnaught Flight Case.....	<b>\$494.99</b>
<b>3I421730</b>	Injection Molded Classical Case.....	<b>494.99</b>
<b>3I421466</b>	Injection Molded Electric Guitar Case (Strat/Tele Shaped Interior).....	<b>419.99</b>
<b>3I421456</b>	Injection Molded Electric Guitar Case (S Style Shaped Interior).....	<b>419.99</b>
<b>3I42140P</b>	Injection Molded Open Cavity Electric Guitar Case.....	<b>419.99</b>
<b>3I4214PRS</b>	Injection Electric Guitar Case (PRS Shaped Interior).....	<b>419.99</b>
<b>3I501444</b>	Injection Molded Electric Bass Case P/J Bass Interior.....	<b>469.99</b>
<b>3I50140P</b>	Injection Molded Electric Bass Case (Open Interior).....	<b>469.99</b>

### GIG BAGS

<b>SKBGB66</b>	Electric Guitar.....	<b>\$83.99</b>
<b>SKBGB44</b>	Electric Bass.....	<b>83.99</b>
<b>SKBGB18</b>	Acoustic Guitar.....	<b>83.99</b>

www.skbcases.com

## KYSER LIFEGUARD



KLHA

The Lifeguard Humidifier fits quickly into the sound hole of both classic and standard guitars, effectively sealing the interior body of the guitar. This creates an environment which can then be maintained at proper humidity levels.

<b>KLHA</b>	Steel String.....	<b>\$19.95B</b>
<b>KLHC</b>	Classical.....	<b>19.95B</b>

## PLANET WAVES



PWHTS

The Planet Waves Humidity & Temperature Sensor (HTS) will help maintain the proper climatic conditions.

<b>PWHTS</b>	Humidity Control Sensor.....	<b>\$51.99</b>
<b>PWGHHTS</b>	Guitar Humidifier w/Humidity Control Sensor.....	<b>62.25</b>
<b>PWHPK01</b>	Automatic Humidity Control System.....	<b>35.70</b>
<b>PWHPRP03</b>	Refill 3 Pack.....	<b>25.50</b>



GH

The Planet Waves Guitar Humidifying system protects your guitars from damage even in the driest conditions.

<b>GH</b>	.....	<b>\$16.35</b>
<b>GHR5</b>	Replacement Sponges.....	<b>9.20/3 pk.</b>

## GROVER

<b>7960</b>	Guitar.....	<b>\$15.95</b>
-------------	-------------	----------------

## OASIS

<b>OH1</b>	Guitar.....	<b>\$20.95</b>
<b>OH6</b>	Case.....	<b>20.95</b>
<b>OH5</b>	Guitar Plus, 50% More Humid.....	<b>20.95</b>
<b>OH14</b>	Case Plus, 50% More Humid.....	<b>20.95</b>
<b>OH18</b>	Ukulele.....	<b>20.95</b>
<b>OH21</b>	Upright Bass.....	<b>24.99</b>
<b>OH2</b>	Digital Hygrometer.....	<b>33.95</b>
<b>OH20</b>	Hygrometer Holder.....	<b>9.95</b>
<b>OH26</b>	Mandolin.....	<b>20.95</b>
<b>OH3</b>	OH1 and OH2.....	<b>54.90</b>
<b>OH3P</b>	OH5 and OH2.....	<b>54.90</b>
<b>OH3C</b>	OH6 and OH2.....	<b>54.90</b>
<b>OH3CP</b>	OH14 and OH2.....	<b>54.90</b>
<b>OH4</b>	Humigel Replacement Kit.....	<b>5.95</b>
<b>OH7</b>	Micro-Fiber Polish Cloth.....	<b>6.95</b>
<b>OH22</b>	Grip Strip for your Guitar, Steel String or Classical.....	<b>9.95</b>
<b>OH25</b>	Guitar Leg Rest.....	<b>29.95</b>



7960



OH1

## HUMITRON



Maintains proper moisture level.

<b>DAMPG</b>	.....	<b>\$8.85</b>
<b>DAMPGDLX</b>	Deluxe.....	<b>10.50</b>

## DAMPITS

Prevents cracking, warping & shrinkage due to moisture loss. Room humidity indicator included.



<b>GPIT</b>	Guitar.....	<b>\$28.45</b>
<b>SPIT</b>	Super, Guitar.....	<b>29.45</b>
<b>VPIT</b>	Violin.....	<b>21.70</b>
<b>APIT</b>	Viola.....	<b>22.25</b>
<b>CPIT</b>	Cello.....	<b>23.50</b>
<b>BPIT</b>	Bass.....	<b>25.00</b>
<b>MPIT</b>	Mandolin.....	<b>20.05</b>

## THE GUARD FATHER

Helps prevent drying out and cracking.  
**HE360.....\$4.85**



## HUMISTAT

Controls humidity with the turn of a dial.  
**FIH3.....\$30.50**  
**FIH1.....17.70**



## PEARSE

**JPGH** Guitar.....**\$11.95B**  
**JP523** Case Humidifier.....**24.99B**



## SKB

**SKBCLIP6** Guitar.....**\$34.99**

## TRUSS ROD TOOL



Hardened steel for long life.

- GTTRS1** GrooveTech™ Standard Truss Rod Driver .....\$14.95
- GTTRC2** GrooveTech™ Cheater Driver™ .....14.95
- GP140** 1/4" Tool .....5.00
- GP150** 5/16" Tool .....5.00
- HS233** Allen Wrench .....17.15

## CRUZTOOLS

### KITS



6-in-1 Screwdriver • 5 Metric Hex Keys • 6 inch Hex Keys • Thickness Gauge • 6" Steel Rule • Diagonal Cutter • Capo • 3-LED Flashlight • String Winder • Setup Guide.

- GTGTR1** Guitar .....\$74.95



6-in-1 Screwdriver • 3 Metric Hex Keys • 5 inch Hex Keys • Thickness Gauge • 6" Steel Rule • Diagonal Cutter • Capo • Setup Guide.

- GTBASI** Bass .....\$71.95

## CRUZTOOLS SUPER BRIGHT 9-LED FLASHLIGHT

Nine LEDs provide extremely bright illumination. A cannister holds three AAA batteries (included)

- FL9L** .....\$14.95

## GUITAR FOOT STOOLS



Foot stools that instantly adjusts from 4" to 9" high. 12" by 4" heavy rubber tread foot rest.

- 7590** .....\$18.00
- PGF1** .....23.50
- WFS22** Wood .....27.20
- SG005** .....8.15
- FS100B** 12" x 5.5" Hercules ..29.99
- FS7850B** On Stage .....17.99



Guitarist foot stool. Heavy duty, fully adjustable.

- KM14670** Black .....\$22.99
- KM14670N** Nickel .....22.99
- KM14675** Black .....24.99

## TREM SETTER



Automatically returns floating tremolo to exact zero setting.

- 401000** Hipshot .....\$51.20
- WDTS** WD .....30.00
- HS377** Schaller .....53.05

### TUNE UP KIT

Includes Trem Setter, Non Friction Nut, and Roller String Tree.

- 402000** .....\$58.70

### ROLLER STRING TREES

- 802100** Guitar .....\$16.65

## EZ CHORD



The amazing device that lets you start playing guitar in an instant.

- EZCHORD** .....\$27.99

## ERNIE BALL



### MUSICIAN'S TOOL KIT

6-in-1 screwdriver • Hex wrench set • Ruler • Pegwinder • Heavy duty string cutter • Wonder wipes • Microfiber polish cloth.

- EB4114** .....\$49.99

## NECK CRADLE



The self-aligning cradle rotates on an axis to provide full support to the back or front of the neck for stability during repairs.

- NC65** .....\$48.14

## HEADSTAND



Designed to gently and securely support the guitar. The Headstand makes the string-changing process hassle-free. The compact size and collapsibility allow you to store The Headstand in your case.

- PWHDS** .....\$18.99

## FEEDBACK BUSTER



Acoustic guitar volume control, helps eliminate feedback. Ideal for quiet practicing.

- FBR2** Feedback Buster .....\$9.25

## SCREECHING HALT



Eliminate feedback and enhance stage volume. Soft rubber insert safe for guitar finish. Tapered design allows greater fit to a variety of guitars.

- PWSH01** .....\$10.20

## LUTE HOLE



Feedback Controllers

- LH01** Moderate .....\$39.00B
- LH02** Light .....39.00B
- LH15** Heavy .....39.00B

Available in Maple (MA), Walnut (WA)

- Mahogany (MH) .....\$65.00

## SUPPRESSOR



Controls feedback

- DSC311** Pro 1 Chrome .....\$15.27
- DSB312** Pro 1 Black .....15.27
- DSG313** Pro 1 Gold .....15.27
- DSC301** Pro 9 Chrome .....15.27
- DSB302** Pro 9 Black .....15.27
- DSG303** Pro 9 Gold .....15.27

## THE GUITAR REST

The Planet Waves Guitar Rest turns any flat surface into a guitar stand. Simply lay the Guitar rest over the edge of any level surface and lean your instrument against the "neck pocket" of the guitar rest.

- PWGR01** .....\$13.25
- PWGD01** Guitar Dock .....43.85

## MULTI TOOL



- GTMLT1** .....\$19.95

## ARM REST



Armrest attaches to the edge of a guitar's soundboard to give you more tonal clarity than you would believe.

- JPEAR** Ebony .....\$38.95B

## GUITAR TOOLS



- GTSC1** String Cutter .....\$14.95

Guitar Utility Tool

- 20001** .....\$25.99B

## THE SQUEEZE BALL



- CSB1** Gel Hand Exerciser .....\$4.98B

## DYNAFLEX



Exercise and condition hands, wrist and forearms. Increases hand speed. Improves endurance.

- PWDFP01** Pro Exerciser .....\$39.00
- PWDFP02** Pro Exerciser with docking station .....59.99

## VARIGRIP



Develops strength and dexterity in fingers and hands.

- PWVG01** .....\$19.99

## VITA GRIP/GRIP MASTER

Light Tension, 4 lbs. per finger

- VM13101** .....\$12.50

Medium Tension, 7 lbs. per finger

- VM13102** .....12.50

Light Tension, 5 lbs. per finger

- GML** Blue .....19.25

Medium Tension, 7 lbs. per finger

- GMM** Red .....19.25

Extra Light Tension, 3 lbs. per finger

- GMXL** Yellow .....19.25

Relaxes finger muscles, improves finger coordination. Helps circulation in the hands

# LEVY'S

## Ultra Comfort Guitar Strap – No. 1 Stretch Strap



The original No. 1 Stretch Strap is now being exclusively manufactured and distributed by Levy's. The rubber and polyester webbing of this 2 1/2" guitar strap was developed by engineers in Germany to achieve just the right degree of stretch and strength. It is finished with leather ends and is available in black (BLK) only. Adjustable from 42" to 50". Also available in extra long (XL), which adds 12" to overall length.

**MN01BLK** .....\$39.52

## Standard Guitar Straps – Suede Leather



MSS3

MSS3CP

**MSS3** 2 1/2" Signature Series suede guitar strap with black decorating piping .....\$72.45

**MSS3CP** 2 1/2" Signature Series suede guitar strap with cream decorating piping .....72.45

All straps are available in suede colors below.  
All straps are adjustable from 38" to 53".  
Also available in extra long (XL), which adds 12" to overall length.

### SUEDE LEATHER COLORS



## Printed Polyester Guitar Straps – Jimi Hendrix



001

004

005

007

008

**MPJH2** 2" polyester guitar strap featuring Jimi Hendrix design, with polyester ends and tri-glide adjustment .....\$33.95  
Available in designs 001-008.  
Adjustable to 60".

## Standard Guitar Straps – Suede Leather



MSS7

**MSS7** 2" Signature Series suede guitar strap with tri-glide adjustment .....\$53.60

### SUEDE LEATHER COLORS

Subject to dye lot variations.



## Standard Guitar Straps – Carving Leather

**MVR17** 2 1/2" carving leather guitar strap with decorative red stitching .....\$66.55

Available in black (BLK) only. Adjustable from 41" to 54".

## Standard Guitar Straps – Distressed Leather

**MX26DC** 2 3/4" distressed leather guitar strap with chevron embossing and cobalt blue garment leather backing .....\$112.05

Available in dark brown (DBR) only. Adjustable from 37" to 51".

## Standard Guitar Straps – Garment Leather



DM1FF

DM1SG

**DM1FF** 2 1/2" garment leather guitar strap with Florentine embossing, foam padding and suede backing .....\$72.10

**DM1SG** 2 1/2" garment leather guitar strap with decorative stitching, foam padding and suede backing .....76.25

**M26GF** 2 1/2" garment leather guitar strap with foam padding and suede backing .....70.10

**M17SS** 2 1/2" triple-ply super-soft garment leather guitar strap with contrasting double stitching. Adjustable from 41" to 54" .....143.80

DM1SG, M26GF and M17SS are available in garment colors below.  
All straps are adjustable from 38" to 53".  
Also available in extra long (XL), which adds 12" to overall length.

### GARMENT LEATHER COLORS

Subject to dye lot variations.



M26GF



# LEVY'S

## Printed Polyester Guitar Straps – Sonic-Art™

### MPS2 SONIC-ART™ POLYESTER DESIGNS

2" Sonic-Art™ polyester guitar strap featuring original artist design, with polyester ends and tri-glidge adjustment

MPS2 .....\$29.30

Adjustable to 60".

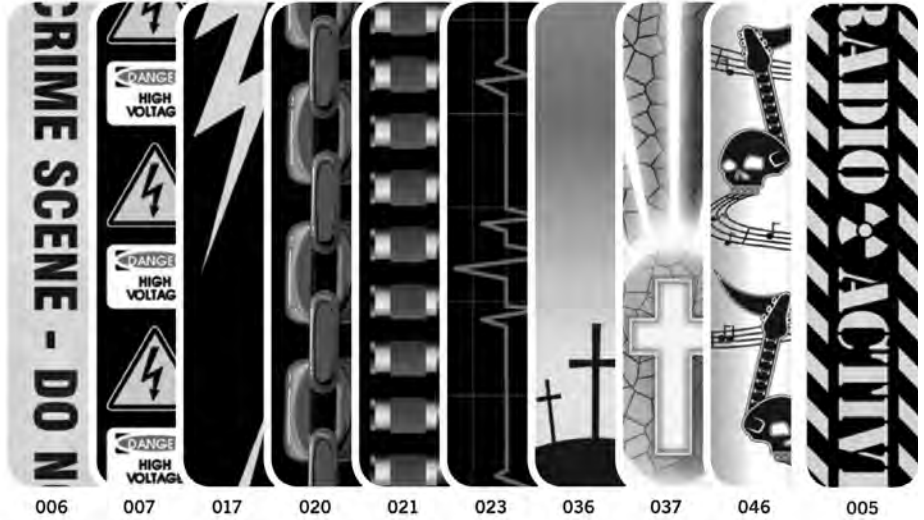

## Printed Polyester Guitar Straps – Rat Fink®

## Printed Polyester Guitar Straps – Rat Fink®



MPRF2 2" polyester guitar strap featuring the Rat Fink® art of Ed "Big Daddy" Roth™, with polyester ends and tri-glidge adjustment .....\$30.95

Available in designs 001-017.  
Adjustable to 60".

Levy's Leathers Limited is an authorized licensee of Ed Big Daddy Roth™ 2005.

MPRF2 2" polyester guitar strap featuring the Rat Fink® art of Ed "Big Daddy" Roth™, with polyester ends and tri-glidge adjustment .....\$30.95

Available in designs 001-017.  
Adjustable to 60".

Levy's Leathers Limited is an authorized licensee of Ed Big Daddy Roth™ 2005.



www.levysleathers.com

## MPD2 - Designer Sublimation Designs

2" polyester guitar strap sublimation-printed with original artist's design, with polyester ends and tri-glide adjustment.

MPD2XX Specify strap # .....\$29.30



## Licensed Guitar Straps Legendary Lyrics



2" polyester guitar strap sublimation-printed with popular song lyric design (excerpt on front, full song on back), with polyester ends and tri-glide adjustment. Available in designs 001 through 013.

MPL2XX Specify strap # .....\$37.88

- MPL2001 I Am The Walrus, John Lennon, Paul McCartney, ©1967, ©1995 Sony/ATV Tunes LLC
- MPL2002 Back in the USSR, John Lennon, Paul McCartney, ©1968, ©1996 Sony/ATV Tunes LLC
- MPL2003 Blackbird John Lennon, Paul McCartney, ©1968, ©1996 Sony/ATV Tunes LLC
- MPL2004 All My Loving, John Lennon, Paul McCartney, ©1964, ©1992 Sony/ATV Tunes LLC
- MPL2005 Day Tripper, John Lennon, Paul McCartney, ©1965, ©1993 Sony/ATV Tunes LLC
- MPL2006 Hello Goodbye, John Lennon, Paul McCartney, ©1967, ©1995 Sony/ATV Tunes LLC
- MPL2007 Ticket to Ride, John Lennon, Paul McCartney, ©1965, ©1993 Sony/ATV Tunes LLC
- MPL2008 Revolution, John Lennon, Paul McCartney, ©1968, ©1996 Sony/ATV Tunes LLC
- MPL2009 Hey Jude, John Lennon, Paul McCartney, ©1968, ©1996 Sony/ATV Tunes LLC
- MPL2010 A Hard Day's Night, John Lennon, Paul McCartney, ©1964, ©1992 Sony/ATV Tunes LLC
- MPL2011 Get Back, John Lennon, Paul McCartney, ©1969, ©1997 Sony/ATV Tunes LLC
- MPL2012 Help, John Lennon, Paul McCartney, ©1965, ©1993 Sony/ATV Tunes LLC
- MPL2013 Come Together, John Lennon, Paul McCartney, ©1969, ©1997 Sony/ATV Tunes LLC



## Genre Guitar Straps - Glam

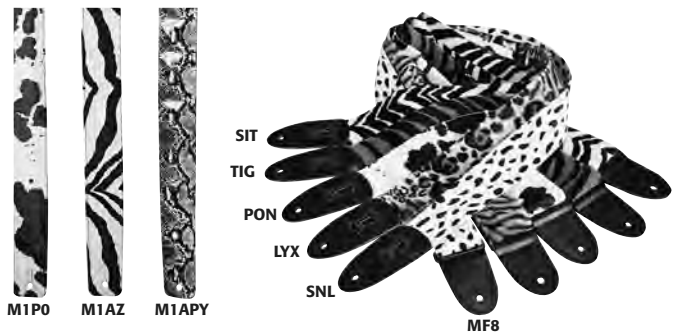

- M1P0 2 1/2" faux pony fur guitar strap with suede backing.....\$43.60  
Also available in zebra (M1AZ) and lynx (M1LY)  
Adjustable from 38" to 53".
- M1APY 2 1/2" vinyl python print guitar strap with suede backing. ....\$43.60  
Adjustable from 38" to 53".
- MF8 2" faux fur guitar strap with leather ends and tri-glide adjustment .....\$23.48  
Available in siberian tiger (SIT), tiger (TIG), lynx (LYX), and snow leopard (SNL). Adjustable to 56".

# LEVY'S

## Printed Polyester Guitar Straps – Artist Series™



003 006 007 016

**MPA2** 2" Artist Series™ polyester guitar strap with original street artist design, with polyester ends and tri-glide adjustment.....\$29.30

## Printed Polyester Guitar Straps – Standard Designs

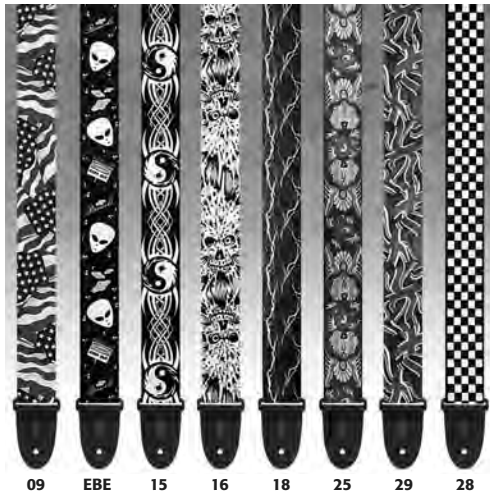

09 EBE 15 16 18 25 29 28

**MP** 2" polyester guitar strap with printed design, polyester ends and tri-glide adjustment.....\$22.75

All straps are available in extra long (XL), which adds 12" to overall length

## Woven Design Guitar Straps – Hootenanny



10 13 M8HT 11 12

**M8HT** 2" 60's Hootenanny jacquard weave guitar strap with polypropylene backing, leather ends, and tri-glide adjustment.....\$30.05  
Adjustable to 54".

### HOOTENANNY PATTERNS

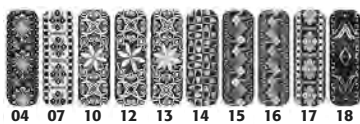

04 07 10 12 13 14 15 16 17 18

## Woven Design Guitar Straps – Southwestern

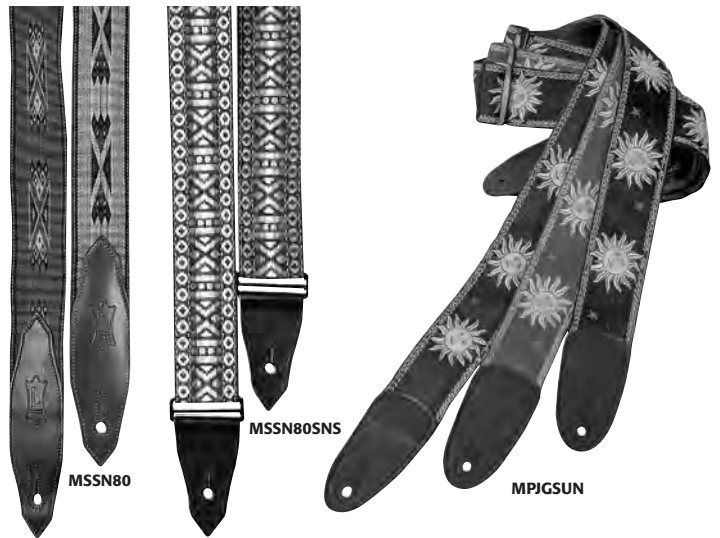

MSSN80

MSSN80SNS

MPJGSUN

**MSSN80** 2" polypropylene jacquard weave guitar strap with leather ends and tri-glide adjustment. Available in southwest Navajo or 60's hootenanny designs .....\$39.75  
(RED), (TAN), (BLU), (SNS)  
Adjustable to 54".

**MPJGSUN** 2" polyester guitar strap with jacquard weave sun design, garment leather backing, leather ends, and tri-glide adjustment .....48.38  
Available in blue (BLU), red (RED) and black (BLK).  
Adjustable to 54".

## Basic Polypropylene Guitar Straps



**M8P3** 3" polypropylene guitar strap with polyester ends and tri-glide adjustment. Available in black (BLK), royal blue (ROY), white (WHT), red (RED), brown (BRN), tan (TAN), navy (NAV) and burgundy (BRG). .....\$14.32  
Adjustable to 54".  
Also available in extra long (XL), which adds 12" to overall length.

# LEVY'S

## Woven Design Guitar Straps – Asian



M8AS



M8ASA

**M8AS** 2" Asian jacquard weave guitar strap with polypropylene backing, leather ends, and tri-glide adjustment.....**\$30.05**  
(BLU), (RED), (GRN), (NAV)

**M8ASA** 2" Asian script jacquard weave guitar strap with polypropylene backing, leather ends, and tri-glide adjustment.....**30.05**

Available in red (RED) and blue (BLU).  
All straps are djustable to 54".

## Basic Guitar Straps – Suede Leather



MS12

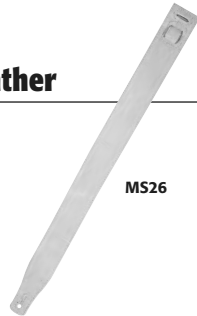

MS26

**MS12** 2" suede guitar strap with suede backing.....**\$46.35**

**MS26** 2½" suede guitar strap with suede backing. ....**49.75**

**MS4** 3½" suede bass guitar strap with suede backing. ....**61.33**

### SUEDE LEATHER COLORS

Subject to dye lot variations.



BLK BRN BRG RST CPR HNY SND TAN SNR BNA RED ROS NAV ROY DGR GRN GRY



## Basic Guitar Straps – Cotton

**MC8** 2" cotton guitar strap with suede ends and tri-glide adjustment .....**\$30.30**  
Available in cotton colors below. Adjustable to 54".

**MC8S** 2" cotton guitar strap with decorative suede strip, suede ends and tri-glide adjustment.....**46.60**  
Available in navy (NAV), black (BLK), green (GRN), and tan (TAN). Adustable to 56.

**MC8TWD** 2" distressed cotton guitar strap with suede ends and tri-glide adjustment .....**46.95**  
Available in brown (BRN), green (GRN), black (BLK), and camo (CAM). Adustable to 60".

**MSSC4** 3" heavy-weight cotton guitar strap with suede ends and tri-glide adjustment .....**50.35**  
Adjustable to 60". Also available in extra long (XL), which adds 12" to overall length. Available in brown (BRN) and black (BLK).

**MSSC8** 2" Signature Series cotton guitar strap with suede ends and tri-glide adjustment .....**34.14**

### COTTON COLORS



BLK BRN BRG TAN NAT GRN RED NAV GRY WHT PAS CAM DCM ACM USA RWB PNK

## Basic Guitar Straps – Leather



M12



M26



DM1

**M1** 2½" leather guitar strap. Adjustable from 37" to 50" .....**\$26.41**  
Also available in chrome-tan colors below.

**M12** 2" leather guitar strap .....**23.75**  
Available in chrome-tan colors below.

**M26** 2½" leather guitar strap .....**26.41**  
Available in chrome-tan colors below.

**DM1** 2½" leather guitar strap with suede backing and decorative double stitch. ....**33.75**  
Also available in chrome-tan colors below.

All straps are adjustable from 38" to 53".  
Also available in extra long (XL), which adds 12" to overall length.

### CHROME-TAN LEATHER COLORS

Subject to dye lot variations.



BLK DBR BRN WAL BRG TAN RED NAV GRY WHT

## Basic Guitar Straps – Garment Leather



MSS7G

**MSS7G** 2" Signature Series garment leather guitar strap with suede backing and tri-glide adjustment. BLK, BRN .....**\$63.98**

**MSS7GP** 2" Signature Series garment leather guitar strap with easy-slide polypropylene and tri-glide adjustment. BLK, BRN.....**53.98**

## Basic Guitar Straps – Soft-Hand Polypropylene



M15



M88

**M8BLK** 2" Black .....**\$26.26**

**M15** 2" soft-hand polypropylene guitar strap with quick-release ends and tri-glide adjustment .....**38.28**

**MSS8** 2" Signature Series soft-hand polypropylene guitar strap with leather ends and tri-glide adjustment .....**29.19**

### SOFT-HAND POLYPROPYLENE COLORS



BLK BRN BRG TAN RED NAV ROY LTB GRY MLT

www.levysleathers.com

# LEVY'S

## Basic Guitar Straps – Polypropylene



M8POLY

**M8POLY** 2" polypropylene guitar strap with tri-glide adjustment and polyester end.....\$5.93

**8POLYXLBKB** Extra long.....6.82

### POLYPROPYLENE COLORS



BLK BKB BRN BRG TAN GRN RED NAV ROY YEL GRY WHT PNK PRP

## Classic Guitar Straps – Padded Leather



M17T03TAN

MSS1

MSS2

**MSS1** 2½" Signature Series carving leather guitar strap with foam padding and garment leather backing .....\$97.01  
*Available in carving colors below.*

**MSS2** 2½" Signature Series garment leather guitar strap with foam padding and garment leather backing.....83.07  
*Available in garment colors below.*

**MV17** 2½" carving leather guitar strap with decorative cable stitching. **Adjustable from 41" to 54"** .....60.47

**M17T03** 2½" carving leather guitar strap tooled with a Kokopelli design, with garment leather backing .....115.37  
*Also available in carving colors below.*

### GARMENT LEATHER COLORS

*Subject to dye lot variations.*



BLK DBR BRN BRG TAN RED NAV BLU GRN WHT

### CARVING LEATHER COLORS

*Subject to dye lot variations.*



BLK DBR BRG BRN WAL TAN RUS NAT CRA

## Classic Guitar Straps – Padded Leather



MSS80



**MSS80** 2" carving leather guitar strap with foam padding and garment leather backing .....\$94.25



*Also available in carving colors*

BLK BRN TAN

## Classic Guitar Straps – Padded Leather



MG12PDX



DM1PD

**MG12PDX** 2" garment leather guitar strap with foam padding and garment leather backing .....\$85.60  
*Available in garment colors below.*

**DM1PD** 2½" leather guitar strap with foam padding and garment leather backing .....49.49  
*Available in chrome-tan colors below.*

### GARMENT LEATHER COLORS

*Subject to dye lot variations.*



BLK DBR BRN BRG TAN RED NAV BLU GRN WHT

### CHROME-TAN LEATHER COLORS

*Subject to dye lot variations.*



BLK DBR BRN WAL BRG TAN RED NAV GRY

## Genre Guitar Straps – Rockabilly



M25



M11

**M25** ¾" carving leather guitar strap with classic 50's pad and buckle adjustment .....\$43.94  
*Available in carving colors*

**M11** .....14.77

**M4N** 3½" leather guitar strap with leather musical notes inlay and suede backing .....\$47.98

**M8BLK** 2" Black Woven Strap .....26.26

## Genre Guitar Straps – Christian



DM7



DM1SGC

DM1SGN

**DM7** 2½" leather guitar strap with leather Holy cross inlay and suede backing .....\$66.99

**DM1SGC** 2½" leather guitar strap with super-embossed Christian cross and suede backing.....66.99

**DM1SGN** Same as DM1SGC with super-embossed musical notes .....55.93



BLK DBR BRN WAL BRG TAN RED NAV GRY WHT

# LEVY'S

## Genre Guitar Straps – Christian

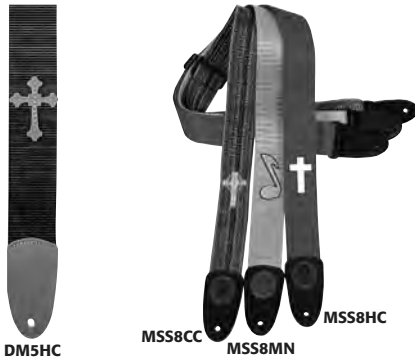

- DM5HC** 2" soft-hand polypropylene guitar strap with leather Holy Cross applique, leather ends and tri-glide adjustment .....\$36.65  
*Also available in soft-hand polypropylene colors below.*
- MSS8CC** 2" soft-hand polypropylene guitar strap embroidered with Celtic cross, with leather ends and tri-glide adjustment.....\$39.75  
*Also available in soft-hand polypropylene colors below.*
- MSS8HC** Same as MSS8CC embroidered with Holy cross .....\$39.75

All straps are adjustable to 54".  
 All straps except MSS7CC, MSS7MN, and MSS7HC are available in extra long (XL), which adds 12" to overall length.



## Genre Guitar Straps – Hard Rock

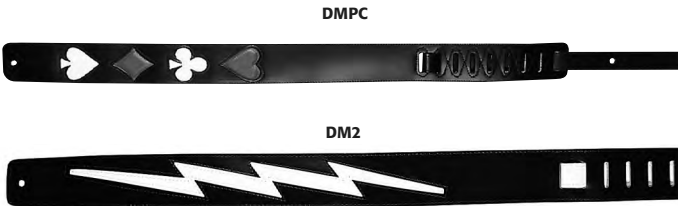

- DM2** 2½" leather guitar strap with leather lightning bolt inlay and suede backing.....\$66.99  
*Available in chrome-tan colors below. Leather inlays come in white, except for DBR which comes with tan, BRN which comes with tan, WAL which comes with tan, TAN which comes with brown, and WHT which comes in black.*
- DMPC** 2½" leather guitar strap with leather playing card suit inlays and suede backing .....\$61.60  
*Available in white (WHT) or black (BLK).*

## Genre Guitar Straps – Hard Rock



- DM1SGF** 2½" garment leather guitar strap with decorative flame stitching and suede backing .....\$66.99  
*Available in garment colors below.*



## Genre Guitar Straps – Christian



- M17CHC** 2½" chrome tan leather guitar strap with Christian cross embossing. ....\$36.80  
*Available in burgundy (BRG), black (BLK) and tan (TN). Also available in chrome tan colors pictured below. Adjustable from 41" to 54". Also available in extra long (XL), which adds 12" to overall length.*
- M17CPH** 2½" chrome tan leather guitar strap with praying hands embossing. ....\$36.80  
*Available in navy (NAV), brown (BRN) and red (RED). Also available in chrome tan colors pictured below. Adjustable from 41" to 54". Also available in extra long (XL), which adds 12" to overall length.*

## Genre Guitar Straps – Hard Rock



- DM5** 2" soft-hand polypropylene guitar strap with leather lightning bolt applique, leather ends and tri-glide adjustment .....\$36.65  
*Available in soft-hand polypropylene colors below.*

## Genre Guitar Straps – Hard Rock

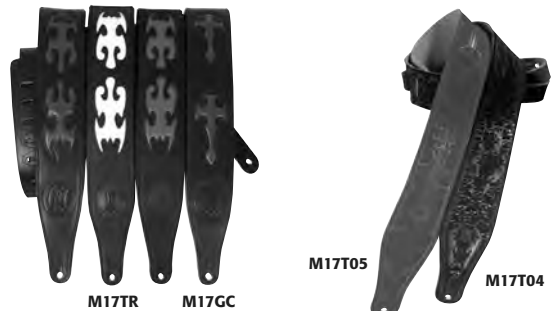

- M17TR** 2½" leather guitar strap with leather tribal design inlays, foam padding, and garment leather.....\$64.51  
*Available in black with burgundy (BLK/BRG), white (BLK/WHT) and red (BLK/RED).*
- M17T05** 2½" suede leather guitar strap tooled with a bats design, with suede backing .....\$89.51  
*Also available in suede colors.*



# LEVY'S

## Special Materials Guitar Straps – Tread Wear®



**M8HR** The Original Hot Rod Strap™ was designed by country recording star Eric Heatherly. This 2" wide strap features genuine seatbelt polyester, auto seatbelt buckle, leather ends and tri-glide adjustment.  
 Patent no. 6,269,991 / 6,405,908. ....\$72.97  
 Adjustable to 56". Also available in extra long (XL), which adds 12" to overall length.

## Designer Guitar Straps – Rayon Webbing

**MSSR80** 2" rayon webbing guitar strap with leather ends and tri-glide adjustment. Available in black (BLK), natural (NAT), and brown (BRN). ....\$46.71  
 Adjustable to 60". Also available in extra long (XL), which adds 12" to overall length.

**MG70R** 2" rayon guitar strap with garment leather ends and tri-glide adjustment .....\$73.05  
 Adjustable to 50" to 58". Available in black (BLK), natural (NAT), brown (BRN). Also available in extra long (XL) which adds 12" to overall length.

## Genre Guitar Straps – Levy Metal



**M17BP1** 2½" leather guitar strap curved barbell body piercing jewelry, foam padding, and garment leather backing .....\$106.56  
 Available in black (BLK) only. Adjustable from 41" to 55".

## Genre Guitar Straps – Hard Rock



**M1SC** 2½" leather guitar strap with skull and crossbones embossing. Black (BLK), white (WHT) .....\$33.41

**M1R** 2½" leather guitar strap with rose embossing .....\$33.41

**MDL8** 2" polyester guitar strap with sublimation-printed skull design, distressed leather ends and tri-glide adjustment .....\$41.75  
 014, 015, 016. Adjustable to 61".

### COTTON COLORS



### SOFT-HAND POLYPROPYLENE COLORS



## Genre Guitar Straps – Levy Metal



M1SD

**M1SD** 2½" leather guitar strap with metal studs .....\$44.85  
 Available in black (BLK), red (RED), white (WHT). Adjustable from 38" to 53".



MSSC8SD

**M17SD** 2½" leather guitar strap with metal studs and rivets, foam padding, and garment leather backing .....\$61.74  
 Available in black (BLK) or white (WHT). Adjustable from 41" to 55".



M17SD

**MSSC8SD** 2" cotton guitar strap with metal studs, suede ends, and tri-glide adjustment .....\$35.10  
 Available in black (BLK) only. Adjustable to 56".

**MSS8E** 2" soft-hand polypropylene guitar strap with ¼" nickel eyelets, leather ends and tri-glide adjustment .....\$33.71  
 Available in soft-hand polypropylene colors below. Adjustable to 56".

## Acoustic Guitar Straps



MSS60SG

**MSS60SG** 2½" tapering to 1" garment leather acoustic guitar strap with decorative stitching, foam padding and suede backing. ....\$87.19  
 Available in black (BLK). Adjustable from 44" to 58". Also available in extra long (XL), which adds 12" to overall length.

## Kid's Guitar Straps



M8PJ

**M8PJ** 1½" polypropylene kids' guitar strap with moveable leather pad, leather ends and tri-glide adjustment. ....\$21.03  
 Available in red (RED), blue (BLU) and black (BLK). Adjustable to 38".



M8PIG

**M8PIG** 1½" polypropylene girls' guitar strap with moveable leather pad, leather ends and tri-glide adjustment. ....\$25.20  
 Available in pink (PNK), purple (PRP) and light blue (LTB). Adjustable to 38".

# LEVY'S

## Bass Guitar Straps



- M4GF** 3½" leather garment leather bass strap with foam padding and suede backing .....\$75.37
- M4** 3½" leather bass strap .....29.37  
Available in chrome-tan colors below.

### CHROME-TAN LEATHER COLORS

*Subject to dye lot variations.*



### GARMENT LEATHER COLORS

*Subject to dye lot variations.*



## Mandolin Straps/Dobro



- M19PR** ½" carving leather mandolin strap with feed-through adjustment .....\$42.95
- M19DX** ½" carving leather mandolin strap with antiqued brass buckle adjustment .....26.46  
Available in carving colors below.
- MS19** ¾" suede leather mandolin strap.....29.29  
Available in suede colors below.
- M19** ¾" leather mandolin strap .....21.00
- MSS6BLK** Leather dobro strap.....72.42  
Available in chrome-tan colors below.

### CARVING LEATHER COLORS

*Subject to dye lot variations.*



## Classical Guitar/Ukulele Straps



- M20BLK** 1" nylon classical guitar/ukulele strap with plastic sound-hole hook and tri-glide adjustments .....37.67  
Available in black (BLK) only. Adjustable from 27" to 36"
- M20LBLK** 1" leather classical guitar strap with plastic sound-hole hook and tri-glide adjustments .....\$37.67  
Available in black. Adjustable from 27" to 36".
- M20PDXBLK** 1½" neoprene padded classical guitar/ukulele strap with garment leather backing, nylon webbing, plastic sound-hole hook and tri-glide adjustments .....62.75  
Available in black (BLK) only. Adjustable from 30" to 35".
- M22BLK** ¾" cotton webbing ukulele strap with plastic sound-hole hook and tri-glide adjustment.....25.25  
Available in black (BLK) only. Adjustable to 25"

## Banjo Straps



- M9** 2" leather banjo strap with metal clips and tri-glide adjustment .....\$39.52  
Available in chrome-tan colors below. Adjustable to 60".
- M10** 2" soft-hand polypropylene banjo strap with metal clips and tri-glide adjustment .....23.76  
Available in soft-hand polypropylene colors below. Adjustable to 60".
- MC10** 2" cotton banjo strap with metal truss-rod clips, and tri-glide adjustment.....31.65  
Available in black (BLK), burgundy (BRG), brown (BRN)
- PM14** 2½" leather banjo strap with sheepskin lining and cradle attachments .....61.76  
Available in chrome-tan colors below. Adjustable from 62" to 68".
- PMB42** 2" carving leather banjo strap with sheepskin lining and Chicago screw attachments .....130.60  
Available in Walnut. Adjustable from 44" to 53".

### CHROME-TAN LEATHER COLORS

*Subject to dye lot variations.*



### SOFT-HAND POLYPROPYLENE COLORS



**IF YOU ARE LOOKING FOR A LEVY'S PRODUCT AND DON'T SEE IT LISTED, GIVE US A CALL. SPECIAL ORDERS ARE AVAILABLE.**

**GUITAR STRAP DISPLAYS ARE AVAILABLE  
ASK ABOUT QUANTITY SPECIAL PRICING**

www.levysleathers.com



# PLANET WAVES / D'ADDARIO



Rock Star  
50C01 .....\$30.60



Rain Forest  
50A04 .....\$30.60

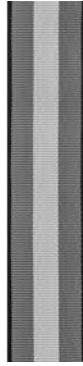

Jamaica  
50A06 .....\$30.60  
Celtic  
50A07 .....30.60



Chopper  
50C03 .....\$30.60



Stars & Stripes  
50A10 .....\$30.60  
Cranium  
50D02 .....\$29.00



Black Satin  
50B01 .....\$30.60  
Union Jack  
50A11 .....30.60



Voodoo  
50A12 .....\$30.60



Hold Em  
50D01 .....\$30.60



Aloha  
50C04 .....\$30.60



Black/Grey Tatoo  
50F078 .....\$29.99



50A13 Henna .....\$30.60  
50E02 Stained Glass.....29.99



50E02



50C08 Monterey .....\$30.60



50C02 Check Mate .....\$30.60



50E03 Saugerties.....\$30.60



50D02 Cranium .....\$29.00  
50F078 Black/Gray Tattoo.....\$30.60  
50B01 Black Satin .....30.60



## The Woodstock™ Strap Collection

Wisely regarded as one of the greatest moments in music history, Woodstock has become known as a celebration of peace, love, and music. Planet Waves celebrates this historic event with the officially licensed Woodstock Strap Collection. These straps infuse the sound, style, and atmosphere that still live on to this day.

50W03 3 Days .....\$36.00  
50W04 Tie Dye .....\$36.00  
50W05 Army 69 .....\$36.00  
25LW01 Tix - Leather.....\$44.00  
25LW06 Peace Flag - Leather .....\$44.00



50W03



50W04



50W05



25LW01



25LW06

# PLANET WAVES/D'ADDARIO

## Classic Leathers



**25L00DX** Leather - Black.....**\$23.45**  
**25L01DX** Leather - Brown.....**23.45**



**25LS00DX** Leather w/stitch- Blk **\$30.60**  
**25LS01DX** Leather w/stitch- Brn ..**30.60**



**25SL00DX** Garment Leather- Blk **\$54.05**  
**25SL01DX** Garment Leather- Brn ..**52.99**



**25WSTE01** Western Eagle  
 Brn .....**\$44.90**  
**25WSTB00** Basket Weave  
 Blk.....**44.90**

## Icon Leather Strap Collection



**25VNS00DX** Stonewashed  
 Leather - Blk .....**\$40.80**  
**25VNS01DX** Stonewashed  
 Leather - Brn .....**40.80**



**25VNRD01DX** Blasted  
 Leather - Brn .....**\$40.80**  
**25VNRD00DX** Blasted  
 Leather - Blk .....**40.80**



**25LDRG** Dragon.....**\$29.60**  
**25LBIO** Biohazard .....**29.60**  
**25LCHN** Chinese Script .....**28.99**  
**25LCELT** Celtic Knot .....**29.60**  
**25LTRBB** Tribal Band .....**28.99**

## Vented Leather



**25PRF01** Black Rows .....**\$50.00**  
**25PRF03** Whitewashed Blocks.....**50.00**  
**25PRF04** Camel Suede Rosette...**50.00**  
**25PRF05** Honey Suede Apache...**50.00**

## Comfort Leather Strap Collection



**25RVP01DX** Reversible suede strap w/piping - black/brown .....**\$ 54.05**  
**20PLC00DX** 2" Padded strap w/contrast stitch - black .....**83.99**  
**30PL01DX** 3" Padded Leather strap - brown .....**74.99**  
**30PL02DX** 3" Padded Leather strap - burgundy .....**74.99**

## Bass Guitar Straps



74T is a 3" (74mm) wide tubular strap **with an internal pad**. Available only in black, perfect for heavy bass guitars.  
**74T000** .....**\$33.00**

75B is a 3" (75mm) basic wide strap **made of polypropylene**. Available in black only.

**75B000** .....**\$27.00**

## Mandolin Straps

75M series – 3/4" wide mandolin strap made with premium leather  
**75M00** Black .....**\$20.40**  
**75M01** Brown .....**20.40**

## Planet Lock



**50PLA10** Stars/Stripes .....**\$37.75**  
**50PLA05** Black.....**37.75**  
**50PLA04** Barbed Wire.....**37.75**  
**50PLA01** Flames .....**37.75**  
**50PLC01** Rock Star.....**37.75**

## Polypropylene



**PWS100** Black.....**\$8.50**  
**PWS101** Red.....**8.50**  
**PWS102** Blue .....**8.50**  
**PWS105** Silver.....**8.50**  
**PWS106** Pink.....**8.50**  
**PWS107** Green .....**8.50**  
**PWS108** White .....**8.50**  
**PWSPL200** Black Planet Lock.....**22.45**

## Dare Strap



Planet Waves has teamed up with product designer Troy Dare to bring you the patented Dare Strap. Unlike conventional straps, the Patented Dare Strap allows you to spread the weight of your instrument over both shoulders instead of only one. Great for heavy instruments and players with back/neck conditions.

**50DARE000** Dare Strap .....**\$30.60**

# PLANET WAVES/D'ADDARIO

## Joe Satriani Straps

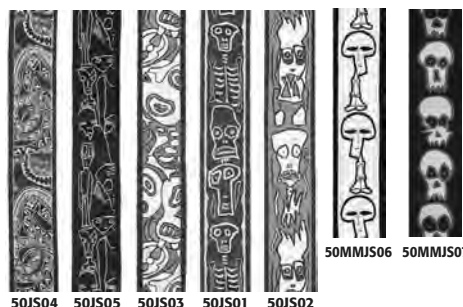

50JS01	Skull N' Bones.....	\$37.75
50JS02	Up in Flames.....	\$37.75
50JS03	Souls of Distortion.....	\$37.75
50JS04	Snakes Mosaic.....	\$37.75
50JS05	Silver Sketches.....	\$37.75
50MMJS06	Spaceman.....	\$37.75
50MMJS07	Skulls.....	\$37.75
25LSJS1	Frog Man, Leather.....	\$37.75
25LSJS2	Grey Man, Leather.....	\$37.75

## Lethal Threat

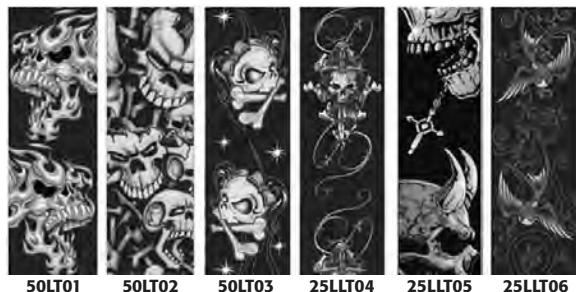

Lethal Threat is on the cutting edge of detail graphics for cars and motorcycles. Their award-winning artists create designs screaming with high speed and power.

50LT01	Flaming Skulls.....	\$37.75
50LT02	Skull Pile.....	\$37.75
50LT03	Girl Skulls.....	\$37.75
25LLT04	Skull Dagger - Leather.....	\$44.00
25LLT05	Saint & Sinner - Leather.....	\$44.00
25LLT06	Rocking Bird - Leather.....	\$44.00

## Dare Strap



Planet Waves has teamed up with product designer Troy Dare to bring you the patented Dare Strap. Unlike conventional straps, the Patented Dare Strap allows you to spread the weight of your instrument over both shoulders instead of only one. Great for heavy instruments and players with back/neck conditions.

50DARE000	Dare Strap.....	\$30.60
-----------	-----------------	---------

## Kiss



KISS is arguably the most iconic band in history. Planet Waves honors KISS with a unique collection of guitar straps featuring album cover artwork and images of Demon, Starchild, Catman, and Spaceman.

25LK01	Kiss.....	\$56.10
25LK02	Rhinestone.....	\$56.10
25LK03	Destroyer.....	\$56.10
25LK04	Rock and Roll Over.....	\$56.10
25LK05	Alive II.....	\$56.10
25LK06	Double Platinum.....	\$56.10
25LK07	Sonic Boom.....	\$56.10

## The Beatles



From *Love Me Do* to *Revolution*, the Beatles were arguably the most creative, diverse and influential band in pop music history. Planet Waves honors the Beatles' legacy with a unique collection of guitar picks and straps, featuring iconic album covers and timeless images which capture the enduring spirit and essence of the "Fab Four."

25LB01	Meet The Beatles.....	\$56.10
25LB02	Hard Day's Night.....	\$56.10
25LB03	Help.....	\$56.10
25LB04	Revolver.....	\$56.10
25LB05	Sgt. Pepper.....	\$56.10
25LB06	Yellow Submarine.....	\$56.10
25LB07	Abbey Road.....	\$56.10
25LB08	Anthology.....	\$56.10

## Pat Metheny Straps

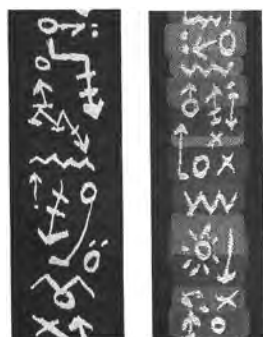

50PM01	Travels.....	\$37.75
50PM02	Watercolors.....	\$37.75

## Shoulder Pads



The Gel Strap Shoulder Pad makes use of a revolutionary gel that transforms your favorite strap into a comfortable, stress-relieving solution for even the heaviest instruments. Thanks to a secure hook-and-loop attachment system, the Gel Strap Shoulder Pad is interchangeable between multiple guitars and straps in an instant!

PWGSP	.....	\$25.50
-------	-------	---------

This molded foam shoulder pad slides over most popular fabric straps for quick relief of playing discomfort.

PWFSP1	.....	\$20.40
--------	-------	---------

## Quick Release System



The Acoustic Guitar Strap Quick Release System\* takes just seconds to set up, it won't come loose while playing, and the extra length of the cord keeps the guitar strap's webbing from interfering with the guitarist's hand.

DGS15	.....	\$17.15
-------	-------	---------

# DUNLOP STRAPS

## Bob Marley Straps



<b>BOB01</b>	Marley Band – Black Cotton .....	<b>\$33.65</b>
<b>BOB02</b>	Marley Hacky Sack – Black Cotton.....	<b>33.65</b>
<b>BOB03</b>	Marley Zig Zag – Natural Hemp .....	<b>33.65</b>
<b>BOB04</b>	Marley Wide – Natural Hemp .....	<b>33.65</b>
<b>BOB05</b>	Marley Face – Polyester .....	<b>33.65</b>
<b>BOB06</b>	Marley Lions – Polyester .....	<b>33.65</b>
<b>BOB07</b>	Marley Ovals – Black Cotton .....	<b>33.65</b>
<b>BOB08</b>	Marley Flowers – Black Cotton .....	<b>33.65</b>

## Classic Woven Guitar Straps



**D3819BK**

### NYLON STRAPS

The D-38 series features easy adjustment custom buckles, patented Custom-Edge® webbing, extra-long strap lengths, 100% leather ends, bold original jacquard woven and poly-woven designs.

<b>D3809BK</b>	Solid Black .....	<b>\$18.52</b>
<b>D3810GY</b>	Cammo Grey .....	<b>18.52</b>
<b>D3811GY</b>	Flambé – Grey.....	<b>18.52</b>
<b>D3811BL</b>	Flambé – Blue.....	<b>18.52</b>
<b>D3811OY</b>	Flambé – Orange Yellow .....	<b>18.52</b>
<b>D3811RD</b>	Flambé – Red .....	<b>18.52</b>
<b>D3814GY</b>	Celtic Grey .....	<b>18.52</b>
<b>D3815CL</b>	Tweed Classic .....	<b>22.50</b>
<b>D3819BK</b>	Grommet Black.....	<b>22.50</b>
<b>D3831BK</b>	Black & White Check.....	<b>22.50</b>
<b>D3831RD</b>	Red Check .....	<b>22.50</b>
<b>D3832GN</b>	Sergeant .....	<b>22.50</b>
<b>D3833GN</b>	GI Cammo .....	<b>22.50</b>
<b>D3834GY</b>	Grey Grommet .....	<b>22.50</b>
<b>D3834KH</b>	Khaki Grommet .....	<b>22.50</b>

## Lucky 13® Guitar Straps



**D3816LS**    **D3817LC**    **D3820LS**    **D3821LD**    **D3822LO**    **D3824LB**



**D3825LG**    **D3842MF**    **D3843SG**    **D3845SP**    **D3846DS**    **D3847SW**

### LUCKY 13

Lucky 13 and Dunlop have joined to bring you full-throttle, in-your-face images! The classic tattoo-inspired images on poly-woven straps with our patented comfort edge webbing and 100% leather ends.

<b>D3816LS</b>	Lucky 13 Skull.....	<b>\$22.50</b>
<b>D3817LC</b>	Lucky 13 Iron Cross.....	<b>22.50</b>
<b>D3820LS</b>	Lucky 13 Japan Tat.....	<b>27.06</b>
<b>D3821LD</b>	Lucky 13 Day of the Dead.....	<b>27.06</b>
<b>D3822LO</b>	Lucky 13 Old School Tattoo .....	<b>27.06</b>
<b>D3824LB</b>	Lucky 13 Beelzebub .....	<b>22.50</b>
<b>D3825LG</b>	Lucky 13 Gun Skull .....	<b>22.50</b>
<b>D3842MF</b>	Lucky 13 L13 MFG .....	<b>27.06</b>
<b>D3843SG</b>	Lucky 13 Skull Gfy .....	<b>27.06</b>
<b>D3845SP</b>	Lucky 13 Skull Paisley.....	<b>27.06</b>
<b>D3846DS</b>	Lucky 13 Diamond Skull .....	<b>27.06</b>
<b>D3847SW</b>	Lucky 13 Skull Wings.....	<b>27.06</b>

# MARVEL GUITAR STRAPS

## Marvel Polyester Guitar Straps

High quality polyester strap with colorful Marvel graphics. Strap adjusts from 38" to 54" in length. 2" strap width.



Marvel Captain America Guitar Strap – 13  
03019450 .....\$24.99B



Marvel Ultimate Spider-Man Guitar Strap – 13  
03019480 .....\$24.99B



Marvel Thor Guitar Strap – 13  
03019500 .....\$24.99B



Marvel Black Widow Guitar Strap – 13  
03019540 .....\$24.99B



Marvel Iron Man 3 Guitar Strap – 13  
03019530 .....\$24.99B



Marvel Hulk Guitar Strap – 13  
03019460 .....\$24.99

## Marvel Leather Guitar Straps

Striking Marvel graphics on high quality genuine leather strap. Strap adjusts from 44" to 50" in length. 2 1/2" strap width.



Marvel Universe Leather Guitar Strap  
03013860 .....\$39.99B



Marvel Ghost Rider Leather Guitar Strap  
03013870 .....\$39.99B



Marvel Six Leather Guitar Strap  
03013880 .....\$39.99B



Marvel Punisher Leather Guitar Strap  
03013890 .....\$39.99B



Marvel Captain America Leather Guitar Strap  
03014020 .....\$39.99B



Marvel X-Men Leather Guitar Strap  
03014030 .....\$39.99B



Marvel Spider-Man Leather Guitar Strap – Black  
03016010 .....\$39.99B



Marvel Spider-Man Leather Guitar Strap – Red  
03016000 .....\$39.99B



Marvel Iron Man 3 Logo Leather Strap  
03020150 .....\$39.99B



Marvel Avengers Leather Strap  
03016030 .....\$39.99B



Marvel Avengers Logo Leather Guitar Strap  
03016020 .....\$39.99B



Marvel Deadpool Jump Leather Guitar Strap  
03017110 .....\$39.99B



Marvel Deadpool Gunfire Leather Guitar Strap  
03017060 .....\$39.99B

# PEAVEY® GUITAR STRAPS

## Premium Accent Straps



Premium level nylon Accent strap. All leather tabs. 2" wide. Straps adjust from 34" to 60". Available in black, red and blue.

- 00565890** Premium Black Accent Strap.....**\$14.99B**
- 00565910** Premium Blue Accent Strap.....**14.99B**
- 00565900** Premium Red Accent Strap.....**14.99B**

## Woven Strap Guitar Straps



2" width. Available in Black, Red, Brown, and Dark Blue. Strap adjusts from 40" to 55", leather tabs.

- 03016800** Blue.....**\$15.99B**
- 03016810** Black.....**15.99B**
- 03016820** Red.....**15.99B**
- 03016840** Brown.....**15.99B**



2.5" wide leather strap in black or brown finish. Adjustable, extra length strap for the taller player needing a longer strap length option.

- 00394760** Tall Man Strap – Black.....**\$15.79B**
- 00394750** Tall Man Strap – Brown.....**15.79B**

## Black Cushion Strap



3" wide Rubatex® strap. Imprinted Peavey logo. Available in black only. Strap adjusts from 43" to 57".

- 00484040** Peavey Black Cushion Strap.....**\$31.99B**

## Black Padded Strap



Durable 2" polypropylene webbing. Double adjustable. Original PARAPAC shoulder pad. Leather tab imprinted with Peavey logo. Strap adjusts from 29" to 54".

- 00089200** Peavey Black Padded Strap.....**\$11.99B**

## Accent Straps



Made of woven nylon, with Peavey logo, 2" width. Straps adjust from 29" to 54".

- 00070920** Black Nylon Accent Strap.....**\$4.39B**
- 00070930** Blue Nylon Accent Strap.....**4.39B**
- 00070940** Red Nylon Accent Strap.....**4.39B**
- 00070950** White Nylon Accent Strap.....**4.39B**

## The Walking Dead Guitar Straps



High quality nylon strap with colorful The Walking Dead graphics. Strap adjusts from 38" to 54" in length. 2" strap width.

- 03021100** The Walking Dead Survivors Guitar Strap.....**\$24.99B**
- 03021090** The Walking Dead Walkers Guitar Strap.....**24.99B**

## Classic Leather Straps



Classic 2" and 3" black leather straps. Imprinted Peavey logo. Straps adjust from 43" to 57".

- 00710740** 2" Black Leather Strap.....**\$10.99B**
- 00710750** 3" Black Leather Strap.....**11.99B**



Black and brown straps have distinctive topside textured, leatherlike material. Also available in black or brown simulated crocodile material. Soft comfortable padding. Polypropylene adjustments. Straps adjust from 41" to 55".

- 00456170** 2.5" Black Leatherlike Strap.....**\$21.99B**
- 00456180** 2.5" Brown Leatherlike Strap.....**21.99B**

## Suede Straps



Fully adjustable. 3" sueded strap with a padded backing. Three color choices. Strap adjust from 43" to 57".

- 00381950** 3" Black Suede Strap.....**\$25.99B**
- 00381940** 3" Brown Suede Strap.....**25.99B**
- 00381960** 3" Tan Suede Strap.....**25.99B**

# JACK DANIEL'S® STRAPS

## Jack Daniel's® Filigree White Oak Strap



Premium black leather strap with suede insert and white filigree graphic. All leather adjustments. Strap adjusts from 38" to 54".

**03000490** Jack Daniel's Filigree White Oak Strap .....\$45.99B

## Jack Daniel's® Old No. 7® Black Label Strap



Glove leather strap with Jack Daniel's® medallion. Suede tabs. Straps adjust from 38" to 54".

**03000470** Jack Daniel's Old No. 7 Black Label Strap .....\$45.99B

## Jack Daniel's® Barrelhouse I Strap



Glove leather strap with woven inset. Includes Jack Daniel's® medallion. Strap adjusts from 38" to 54".

**03000480** Jack Daniel's Barrelhouse I Strap .....\$43.99B

## Jack Daniel's® Tennessee Whiskey Black Strap



Premium black leather strap with distinctive embossed Jack Daniel's® badge. All leather adjustments. Strap adjusts from 38" to 54".

**00568250** Jack Daniel's Tennessee Whiskey Black Strap .....\$59.99B

## Jack Daniel's® Old No. 7 Pin Stripe Straps



Black pin stripe strap with Old No. 7® medallion. Strap includes four Jack Daniel's® picks. Strap adjusts from 48" to 62".

**00565400** Jack Daniel's Old No. 7 Black Pin Stripe Strap .....\$49.99B

**00565410** Jack Daniel's Old No. 7 Brown Pin Stripe Strap .....\$49.99B

## Jack Daniel's® Barrel Stave Straps



2" cotton-webbing strap. Glove leather tab with embossed Jack Daniel's® logo. Strap adjusts from 36" to 60".

**03000520** Jack Daniel's Barrel Stave Black Strap .....\$12.99B

**03000510** Jack Daniel's Barrel Stave Tan Strap .....\$12.99B

## Jack Daniel's® Square Shooter Strap



Leather strap with Jack Daniel's® logo fabric insert. All leather adjustments. Strap adjusts from 45" to 55".

**03000500** Jack Daniel's Square Shooter Strap .....\$29.99B

## Jack Daniel's® Tennessee Straps



Black poly strap with Old No. 7® Jack Daniel's® logo patch. Genuine leather tabs. Strap adjusts from 34" to 60" in length.

**00579670** Jack Daniel's Tennessee Guitar Strap Black .....\$7.99B

**00579880** Jack Daniel's Tennessee Guitar Strap Brown .....\$7.99B

# LM STRAPS



UL1BK



LS314BK

UL1BK 2.5" pad with 1" leather ends.....\$26.25

Leather rock & roll strap with comfort back.

LS314BK Black.....16.50



CRUSH VELVET PS24CVBK Black.....\$27.00



EXTRA LONG 2 1/2" leather, strap adjusts from 35" to 62"  
TM2502BK Black.....\$27.90



DOBRO LS207BK Black.....\$24.00



RM24AF



RM24FL



RM24LS



RM24SC



RM24SN

Ralph Marlin Designer Series, 3" Wide Straps

RM24AF Flag.....\$27.00

RM24FL Flame.....\$27.00

RM24LS Last Supper.....\$27.00

RM24SC Scream.....\$27.00

RM24SN Stary Night.....\$27.00



Three ply garment leather. Top and bottom layer soft garment and simulated suede core construction. Double detail stitched. 2 1/4" strap adjusts from 42" to 60".

SLIMBK.....\$52.50

SLIMBR.....\$52.50



Strap and Lock System combined. Locks securely to any Guitar.

SLL2BK Leather 2" Black \$24.75

SLLPOLYBK Poly Black.....15.75

LADDER WEBBING

SLLADBK Black 2".....19.50



FB1BK



FB1T



FB1GR

FLY BOY 2.5" ergonomic pad with suede underside and a canvas 1.5" wide strap.

FB1.....\$49.50

Black (BK), Tan (T), Gray (GR)



BASS LS322BK Black.....\$39.00



PS201CK PS201SK PS201IC PS201ST

PYRAMID STUDS STRAPS Pyramid studs on 2" wide 1/4" thick heavy duty vinyl with leather ends and quick, easy adjustable 2" poly web section.

PS201CK Checkered.....\$28.50

PS201SK Skull Studs.....\$28.50

PS201IC Iron Cross.....\$28.50

PS201ST 3 Rows Studs.....\$28.50



Rich, detailed leather LS2502BK 2 1/2" Black.....\$27.00

LS2502BR 2 1/2" Brown.....\$27.00



3" poly, silk screened. PS25SK Skulls.....\$27.00

## ALEXIS STRAPS FOR GIRLS



PSCAM

2" Camo Strap PSCAM.....\$15.00

2" Poly Rainbow Strap PS3ERB.....4.35



ALPL Pink Dalmation.....\$23.25  
ALPC Pink Cameo.....\$21.75  
ALFP Pink Poodle.....\$21.75  
ALFL Lilac Poodle.....\$21.75



ALDD  
ALMP



ALDD Daisy Delight.....\$21.75  
ALMP Pink Minky.....\$21.75



# LM STRAPS



3" leather straps with cross symbol.  
**LS309BK** Black .....\$30.00  
**LS309BR** Brown .....30.00



Genuine cowhide straps  
**LS301BK** 3" Black.....\$19.50  
**LS301BR** 3" Brown.....19.50  
**LS2501BK** 2½" Black.....17.25  
**LS2501BR** 2½" Brown .....17.25



**MANDOLIN**  
 Leather strap. Fits F or A style.  
**M1BK** Black .....\$12.00  
**M1BR** Brown .....12.00



**CLASSICAL**  
**C1BK** Black .....\$9.00



3" leather with notes  
**LS326BKW** Black/White .....\$37.50



Silk Screen on Black  
**PS25SK** Skull .....\$25.50



2" ladder webbing.  
**PS31W** White .....\$12.75  
**PS31R** Red .....12.75  
**PS31BK** Black.....12.75  
**PS31BR** Brown .....12.75  
**PS31B** Blue .....12.75  
**PS31AF** American Flag .....12.75



**BANJO**  
 Leather straps.  
**B5BK** Black.....\$28.50  
**B5BR** Brown.....28.50  
 2" black poly pro banjo strap with nylon hooks.  
**B1BK** .....\$9.75  
 Banjo converter. Makes any guitar strap a banjo strap.  
**BACC** .....\$3.00



**HAND PAINTED LEATHER**  
**AB24CR** Cross .....\$30.00



**UKULELE**  
**UK1** 1" Poly .....\$8.25

## NEO TECH STRAP



From ukuleles and mandolins to classical and flamenco guitars, Simple Sling™ can be adjusted to fit in the playing position that's just right. Features a custom felt-lined hook with rounded edges to protect your instrument's finish. It incorporates a smooth herringbone weave ¾" nylon webbing which easily adjusts.  
**SLLING** .....\$8.95



2" Cotton Embroidered  
**CS2C** Light/Cross.....\$20.25  
**CS2J** Jesus.....20.25  
**CS2LCGO** Gold Cross .....20.25  
**CS2LCPU** Purple Cross.....20.25



**PS24RF** Rebel Flag .....\$27.00  
**PS24AF** American Flag .....27.00  
**PS24TG** The Girl.....27.00



Ultra Soft  
 2½" Leather Like  
**UL10LBK** Black .....\$30.00  
**UL10LBR** Brown .....30.00  
**UL10CBK** Black Crocodile .....30.00  
[www.lmproducts.com](http://www.lmproducts.com)

## SCRAPS STRAPS



2" hand distressed and spray painted cotton top w/unique "never two alike" personal tagging by the strap creator, backed w/2" cotton webbing and heavy duty antiqued hardware & recycled oil-tanned leather ends.  
**LMSCG** Green.....\$36.00  
**LMSCB** Blue .....36.00  
**LMSCR** Red .....36.00  
**LMSCBK** Black.....36.00

## ERNIE BALL



Hot glued and sewn leather ends, woven fibers and vivid colors make these straps a sterling value. Available in Black, Silver, Red, White, Blue, Green, Burgundy, Purple and Brown.  
**EB40** .....\$8.50  
[www.ernieball.com](http://www.ernieball.com)

## LM STRAPS



2" silk screened fabric guitar strap.

<b>PS5MH</b> Mental Health.....	<b>\$12.75</b>
<b>PS4LB</b> Lightening Bolt.....	<b>11.25</b>
<b>PS4ST</b> Stars.....	<b>11.25</b>
<b>PS4GP</b> Peace.....	<b>11.25</b>



2" silk screened fabric guitar strap.

<b>PS4RA</b> Radiation.....	<b>\$11.25</b>
<b>PS4TW</b> Toxic Waste.....	<b>11.25</b>
<b>PS4CK</b> Checkerboard.....	<b>11.25</b>
<b>PS4YY</b> Yin Yang.....	<b>11.25</b>



2" silk screened fabric guitar strap.

<b>PS4S</b> Skull & Crossbones.....	<b>\$11.25</b>
<b>PS4PL</b> Police Line.....	<b>11.25</b>
<b>PSMR</b> D.O.C.....	<b>11.25</b>
<b>PS4BW</b> Barbed Wire.....	<b>11.25</b>



2" silk screened fabric guitar strap.

<b>PS4GR</b> Grim Reaper.....	<b>\$11.25</b>
<b>PS4EB</b> Eight Ball.....	<b>11.25</b>
<b>PS4DI</b> Dice.....	<b>11.25</b>
<b>PS4H</b> Small Cross.....	<b>11.25</b>

## RETRO



**FF15T**  
Tan



**FF15O**  
Orange



**FF15B**  
Blue



**FF15G**  
Green



**FF15Y**  
Yellow



**FF15EP**  
Electric  
Pink



**FF15EO**  
Electric  
Orange



**FF15ER**  
Electric  
Red



**FF15P**  
Paisley

2" cotton jacquard weave with poly web underside with leather ends.

<b>FF15</b> .....	<b>\$21.75</b>
-------------------	----------------

## D'ANDREA STRAPS



**1313**.....**\$7.35**

Woven guitar strap in bright colors with heavy duty leather tabs for durability.

**RST** Strap Tie.....**\$ .22**



**1352** 2".....**\$5.85**

Available in Red, Blue, White, Black.

**RG302** Ft. Bryan 3" Black.....**11.60**



**APFW4** Denim.....**\$16.35**

**APFW6** Flag.....**16.35**

**APFW8** Bandanna.....**16.35**



### BANJO

Colorful woven fabric with plastic hooks for easy attachment to the banjo.

**1312** Ace.....**\$9.85**

**GB** Ft Bryan, Hootenany ....**12.55**

**GBBK** Ft Bryan, Black .....**11.15**



### CLASSIC GUITAR

**1200BK**.....**\$8.35**

A soft vinyl neck band for classic guitar. Available in black.

**1300BK**.....**10.00**

Leather neckband for classic guitar. Available in black.

**1399** Woven.....**9.00**



"50s" look skinny guitar strap.

**1472BK** Black.....**\$33.20**

Strap Pad

## SLIDER LM



**SGBK** Guitar, Bass, Black.....**\$36.00**

**SBBK** Banjo, Black.....**36.00**

[www.dandreapicks.com](http://www.dandreapicks.com)

# FORT BRYAN STRAPS



2 1/2" leather with silver conchos.  
**LC502** Black .....\$22.80  
**LC510** Brown .....22.80



2" woven guitar straps. Available in (R) Red, (W) White, (BK) Black, (BR) Brown, (NB) Navy Blue, (SI) Silver and (PB) Med. Blue, (RB) Rainbow  
**FF** .....\$4.70  
**FFWS** Hootenany.....5.90



2 1/2" soft leather.  
**LR102BK** Black, Top Grain ....\$17.55  
**LR142T** Tan .....16.55  
**LR142W** White .....16.55  
**LR142BK** Black.....16.55  
**LR142BR** Brown .....16.55



Leather straps, 3" wide.  
**FBSL38** Black.....\$47.10  
**FBSL40** Tan.....47.10



**BANJO**  
 Leather Straps, Cradle Style.  
**CBSLBK** Black .....\$32.90  
**CBSFBK** Black,  
 Fleece Lined..... 43.55



Woven Guitar Straps  
 Available in black with white web, and white with black web.  
**WEBBK**.....\$13.50  
**WEBW**.....13.50



Colorful woven guitar straps. Available in black (BK), red (R), white (W), silver (SI), brown (BR), navy blue (NB), med. blue (PB), Rainbow (RB), Pink (PI)  
**R20** .....\$5.65



3 1/2" soft leather.  
**LR143T** Tan .....\$18.55  
**LR143W** White .....18.55  
**LR143BK** Black.....18.55  
**LR143BR** Brown .....18.55



Leather with Note  
**SRV103BK** Black .....\$56.65  
**SRV103W** White .....56.65



Leather Strap w/cross  
**CR104BK** Black .....\$44.55  
**CR104W** White .....44.55



**FBCRI** Crime Scene .....\$11.60  
**FBFIR** Fire Dept. ....11.60  
**FBHAZ** Haz Mat .....11.60  
**FBPOL** Police Line .....11.60



**CHEVRON LEATHER SERIES**  
 Handcrafted in America, these genuine, 100% leather straps are 2 1/2" wide and adjust from 48" to 56".  
 Black Leather Strap with 3 White Leather Chevrons  
**CHEVRONBK** .....\$20.25  
 White Leather Strap with 3 Black Leather Chevrons  
**CHEVRONW** .....\$20.25

## AMERICAN MUSIC



**GUITAR**  
 Strap with 3 1/2" pad.  
**BN2BK** 2" Black .....\$24.95  
**BN3BK** 3" Black .....34.95

**BANJO**  
 2" wide, 3 1/2" pad. Cradle style.  
**DBXBK** Black .....\$24.95

## MARTIN STRAPS HOOKS



Guitar Strap Hooks  
**18ASHK BK** Black.....\$7.99B  
**18ASHKBR** Brown.....7.99B  
[www.martinguitar.com](http://www.martinguitar.com)

## TROPHY STRAPS



**GS1B** Blue .....\$3.63  
**GS1R** Red .....3.63  
**GS1BK** Black.....3.63



**LOUNGE LIZARD SERIES**  
 Layered with genuine crushed velvet and sewn on top of 2" black polypro, they're extraordinarily comfortable. Attached to high-strength D-loops, all straps are adjustable from 35" to 60" and are proudly handcrafted in the U.S.A.  
**FBLLBK** Black Jaguar .....\$27.75  
**FBLLB** Blue Diamond .....27.75  
**FBLLR** Casino Red .....27.75  
**FBLLPU** Purple Passion.....27.75

## DI MARZIO STRAPS



Di Marzio Cliplock Guitar Straps. Made of strong nylon web. Available in white, black, blue, red, green, pink, orange, yellow, purple, gray, camo (CM), military green (MG).

**DD2200** 2" .....\$26.00  
**DD2210BK** Black, Metal Buckle .....\$37.00  
**DD2800BK** 3" Bass Guitar .....\$31.00

Di Marzio Cliplock Straps made of elastic stretch material.

**DD2300** Black, 2" .....\$26.00

Nylon Web Guitar Strap, (seat belt material) 2-inch width, leather ends, includes tie cord.

**DD3100NBK** Black .....\$12.95  
**DD3100N** Green, Pink, Orange, Yellow.....\$21.95

Cotton Guitar Strap, (cotton weave) 2-inch width, leather ends, includes tie cord, available in black.

**DD3100CBK**.....\$12.95

ClipLock Cotton Guitar Strap, 2-inch width.

**DD2200CBK** Black .....\$26.00

Elastic Guitar Strap, 2-inch width, leather ends.

**DD3100EBK**Black .....\$18.00

### CLIPS ONLY

**DD2201BK** Black .....\$9.95PR  
**DD2202BK** Black, Extra Long.....9.95PR

### URBAN DECAY

**DD3243** Black or White .....\$59.00

Custom Italian Leather

**DD3252** Black .....\$79.00  
**DD3242** Black, No Metal .....\$69.00

[www.dimarzio.com](http://www.dimarzio.com)



## STRAP SYSTEMS



### PLANET WAVES

Acoustic Guitar Strap Quick Release System.  
**DGS15**.....\$7.15

[www.planetwaves.com](http://www.planetwaves.com)

## FENDER STRAPS



### Monogrammed Leather

Our New Fender monogram straps features our most popular design tooled right into high quality, 3 ply leather. Full adjustable, a truly broken-in feel.

**0681006** Black .....\$49.99

**0681050** Brown .....49.99

### 2 1/2" Genuine Leather Straps

Feature an embossed Fender logo.

**0611006** 2 1/2" Leather Small Rivets Strap, Black .....\$99.99

**0612006** 2 1/2" Leather Punched Holes Strap, Black .....69.99

**0613006** 2 1/2" Leather Lightning Bolt Strap, Black .....69.99

### Deluxe 3 1/4" Wide Padded Leather

**0665006** Deluxe Wide, Black.....\$79.20

**0665050** Deluxe Wide, Walnut .....79.20

### Vintage-Style 3/4" Straps w/Pad

**0664006** Super Deluxe Black .....\$31.70

**0664021** Super Deluxe Natural.....\$31.70

**0689** Deluxe Standard Blk.....19.80

### 2" Genuine Woven Straps

Feature leather ends with embossed Fender logo.

**0614001** 2" Hootenanny Woven Strap, Red .....\$29.99

**0614002** 2" Hootenanny Woven Strap, Grey/Black .....29.99

**0614003** 2" Hootenanny Woven Strap, Brown/Gold .....29.99

### Plain Leather Strap

**0663006** Black w/Gold Logo.....\$21.80

**0663050** Brown w/Gold Logo.....21.80

### 2" Genuine Nylon Straps

Feature leather ends with embossed Fender logo.

**0615001** 2" Nylon Diamond Strap, Black/Grey .....\$19.99

**0615002** 2" Nylon Checker Board Strap, Black/White.....19.99

**0615003** 2" Nylon American Flag Strap, Black .....19.99

**0615004** 2" Nylon Stars and Stripes Strap, Black/Grey .....19.99

**0613106** 2" Nylon Lightning Bolt Strap, Black .....14.99

### Vintage Tweed Strap

**0687** 2" Tweed (soft) .....\$16.85

### Monogrammed Straps

**0681000** Black/Yellow/Brown .....\$16.85

**0681500** Black/Yellow/Red .....16.85

**0681502** Black/Lt Gry/Med Blue .....16.85

**0681543** Black/Lt Gry/Drk Gry .....16.85

**0682** Red/White/Blue.....16.85

**0683** White/Brown/Yellow .....16.85

### 2" Poly Logo Strap

**0662070** Black/Yellow Logo.....\$9.90

**0662015** Black/Red Logo .....9.90

**0662080** Black/White Logo .....9.90

**0662043** Black/Pewter Logo .....9.90

### Woven "Running" Logo Strap

**0671** Black/Silver .....\$16.85

### Leather Straps

**EVH42** Van Halen, 42".....\$60.00

**EVH62** Van Halen, 62" .....60.00

### Strap Locks & Buttons

**0690** Security Locks/Pair .....\$18.35

**4915000** Vintage Buttons/Pair .....6.40

**4914000** Standard Strap Button .....7.30

**0819** Strap Locks,

1 pr. Black/1 pr. Red.....4.05 pk.

[www.fender.com](http://www.fender.com)

## NEO-TECH STRAPS

Learn more at [www.neotechstraps.com](http://www.neotechstraps.com)

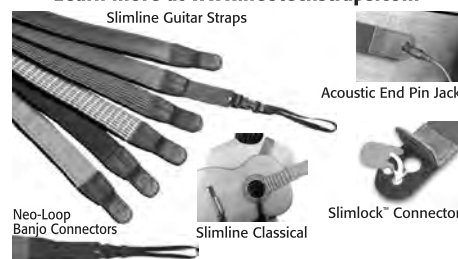

**SLIMLINE STRAP™** 2.25" wide non-stretch memory foam pad with nylon webbing or leather on top. Webbing: (\*BK) Black, (\*R) Red, and (\*RB) Royal Blue. Leather: (\*BK) Black, (\*BR) Brown.

**SGSR \*** Regular, Webbing, Slimlock™ .....\$31.95

**SGSL \*** Long, Webbing, Slimlock™ .....33.95

**SLSR \*** Regular, Leather, Slimlock™ .....39.95

**SLSL \*** Long, Leather, Slimlock™ .....43.95

**SLBRBK** Regular, Banjo, Webbing .....27.95

**SLBR \*** Regular, Banjo, Leather.....35.95

**SAGSL \*** Long, Webbing, Acoustic End Pin Jack/Slimlock™. 35.95

**SAGSL \*** Long, Leather, Acoustic End Pin Jack/Slimlock™. 45.95

**SCSRBK** Classical, Black Webbing .....27.95

**SCSR \*** Classical, Leather .....38.95 (insert color at \*)

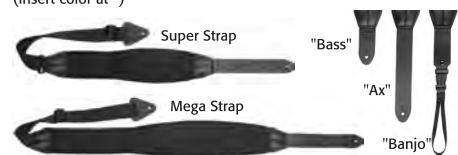

**SUPER STRAP™** with pad made of black neoprene laminated with elastic for long-lasting comfort.

**MEGA STRAP™** uses the same construction but with a longer and wider pad. Both available in Ax, Bass, and Banjo versions.

**SASBK** Super, Ax.....\$32.50

**SBSBK** Super, Bass.....32.50

**SBJBK** Super, Banjo .....32.50

**MAS** Mega, Ax .....42.95

**MBS** Mega, Bass.....39.95

**MBSS** Mega, Bass, Short.....39.95

**MBJS** Mega, Banjo.....44.25

**JAMMIN' STRAP™** with pad made of neoprene laminated with elastic and memory foam. Available in (\*BK) Black, (\*R) Red, (\*RB) Royal Blue, (\*G) Green or (\*GR) Steel Gray. Also available in regular and long lengths with standard leather or Cam-Lock connections. (Insert color at \*)

**JSR \*** Regular, Std. Leather.....\$33.95

**JSLBK** Long, Std Leather .....35.50

**JSR \* CL** Regular, Cam-Lock.....38.95

**JSLBKCL** Long, Cam-Lock.....42.95



**MANDOLIN/UKULELE STRAP™** with neoprene pad and fully adjustable connectors to fit a wide variety of instruments.

**SIMPLE SLING™** 3/4" nylon webbing adjusts easily for ukuleles, mandolins, flamenco or classical guitars.

**MSBK** Mandolin/Ukulele Strap.....\$29.95

**SSLING** Simple Sling.....8.95

**ACOUSTIC GUITAR HARNESS** with neoprene yoke and non-marring felt-lined hooks to protect instrument's finish.

**AGH** Regular.....\$55.00

**AGHXL** X-Long.....56.00

## STRAP LOCK SYSTEMS

### DUNLOP



Set (2 units for instrument and strap) adapts to instrument by replacing existing strap pins/screws with special Straplok® System buttons/screws. Two strap attachments are included for your strap. Available in four finishes and four button styles.

#### ORIGINAL

Complete Basic Set (2 units/for instrument and strap)

SLS 1101	Nickel	.....	\$21.15
SLS 1102	Brass	.....	23.44
SLS 1103	Black	.....	23.44
SLS 1104	Gold	.....	30.60

#### TRADITIONAL

Traditional button shape comes with an extra wide flange.

SLS 1501	Nickel	.....	\$21.15
SLS 1502	Brass	.....	23.44
SLS 1503	Black	.....	23.44
SLS 1504	Gold	.....	30.60



#### DUAL DESIGN

Wider flange button provides extra security

SLS 1031	Nickel	.....	\$21.15
SLS 1032	Brass	.....	23.44
SLS 1033	Black	.....	23.44
SLS 1034	Gold	.....	30.60



#### FLUSH MOUNT

Internal mounting feature for sleeker profile

SLS 1401	Nickel	.....	\$21.15
SLS 1402	Brass	.....	23.44
SLS 1403	Black	.....	23.44
SLS 1404	Gold	.....	30.60



www.jimdunlop.com



### PLANET WAVES

End Pins

PWEP102	Pair, Black	.....	\$10.20/2
PWEP202	Pair, Chrome	.....	10.20/2
PWEP302	Pair, Brass	.....	10.20/2

Rotating Elliptical End Pin

PWREP202	Chrome	.....	\$25.50 set
----------	--------	-------	-------------

## SCHALLER



445	Nickel	.....	\$20.15/set
446	Chrome	.....	24.10/set
447	Gold	.....	35.85/set
1446	Black	.....	30.75/set

## ERNIE BALL



EB4600	Nickel	.....	\$30.00
EB4601	Black	.....	35.00
EB4602	Gold	.....	44.00

## Q PARTS



Fire Wheel



Aztec

	Chrome	Black	Gold	
Aztec	SLC1502	SLB1501	SLG1503	.....\$24.00
Fire Wheel	SLC1505	SLB1504	SLG1506	.....24.00
Sun	SLC1508	SLB1507	SLG1509	.....24.00
Western	SLC1511	SLB1510	SLG1512	.....24.00
Standard	SLC1514	SLB1513	SLG1515	.....24.00

www.qparts.com

## STRAP BUTTONS



### PEAVEY® GUITAR STRAP BUTTONS

Package includes two complete strap buttons (buttons, screws and felt washers).

00050800	Guitar Strap Buttons (Chrome)	.....	\$4.39B
00069250	Guitar Strap Buttons (Black)	.....	4.39B
00069260	Guitar Strap Buttons (Gold)	.....	4.79B

7100SI	Chrome, 24	.....	27.70/CD
EP24C	Chrome, 24	.....	29.15
EP24BK	Black, 24	.....	32.75
EP2	Black, Chrome, Brass (G)	.....	4.15/2
EB4237	Chrome, 12	.....	9.25/bag
SF0091	Chrome, Vintage	.....	8.35/12
SF0092	Gold, Vintage	.....	16.75/12
SF0093	Black, Vintage	.....	12.60/12
MM5610BK	(2) Black	.....	5.50
MM5610C	(2) Chrome	.....	4.50
MM5610GO	(2) Gold	.....	5.50
MM5612C	(2) Oversize, Chrome	.....	4.50
MM5612GO	(2) Oversize, Gold	.....	5.00
MM5612BK	(2) Oversize, Black	.....	5.00

## GROVER

610C	Skull, Chrome	.....	\$14.95/2
610G	Skull, Gold	.....	19.95/2
620C	Eagle, Chrome	.....	14.95/2
620G	Eagle, Gold	.....	19.95/2
630C	Star, Chrome	.....	14.95/2
630G	Star, Gold	.....	14.95/2
640C	Iron Cross, Chrome	.....	14.95/2
640G	Iron Cross, Gold	.....	19.95/2

## ON/STAGE

### HENNESSEY™ STRAP LOCKS

Constructed from solid brass.

NSL7200C	Chrome Finish	.....	\$30.99
NSL7200B	Black Finish	.....	32.99
NSL7200G	Gold Finish	.....	33.99

## LOK STRAP



36 Disk Locks In Convenient Display.

7036	.....	\$52.76	
7007J	Ergonomic 50 Disk Display	.....	83.60
7000	Set of 2	.....	4.72
7007	Set of 2, Ergonomic	.....	5.02

## PRO ROCK GEAR



RGSL10	Chrome	.....	\$17.70
RGSL20	Black	.....	20.40
RGSL30	Gold	.....	27.60
RGSL40	Nickel	.....	17.70
RGSL50	Black Nickel	.....	20.40
RGSL60	Antique Silver	.....	24.90
RGSL70	Antique Bronze	.....	24.90
RGSL10S	Satin Chrome	.....	27.60
RGSL20S	Satin Black	.....	30.60
RGSL30S	Satin Gold	.....	31.65
RGSL40S	Satin Nickel	.....	23.70

## STRAP LOCK



Prevents accidental dropping of guitars. Genuine leather, easy to install.

SL12BK	.....	\$3.15 ea.
--------	-------	------------

## GROVER

GP800N	Nickel	.....	\$20.05
GP800C	Chrome	.....	22.45
GP800BK	Black	.....	26.95
GP800GO	Gold	.....	28.95

#### END PINS

GP810N	Nickel	.....	\$4.95/2
GP810C	Chrome	.....	4.95/2
GP810BK	Black	.....	5.50/2
GP810GO	Gold	.....	5.50/2

# D'ADDARIO STRINGS

## Electric Guitar

### XL Nickel Round Wound



<b>EXL110</b>	Regular Light .010-.046.....	<b>\$10.10</b>
<b>EXL1107</b>	Regular Light 7-string .010-.059.....	<b>13.10</b>
<b>EXL110W</b>	Regular Light/Wound 3rd .010-.046.....	<b>11.05</b>
<b>EKXL110</b>	Regular Light/Soldered Twists .010-.046.....	<b>12.50</b>
<b>ESXL110</b>	Regular Light/Double Ball End .010-.046.....	<b>26.55</b>
<b>EXL110+</b>	Regular Light Plus .0105-.048.....	<b>10.10</b>
<b>EXL111</b>	Balanced Tension/Regular Light .010-.046.....	<b>10.10</b>
<b>EXL115</b>	Blues/Jazz Rock .011-.049.....	<b>10.10</b>
<b>EXL115W</b>	Blues/Jazz Rock/Wound 3rd .011-.049.....	<b>11.05</b>
<b>EXL116</b>	Medium Top, Heavy Bottom .011-.052.....	<b>11.05</b>
<b>EXL117</b>	Medium Top, Extra Heavy Bottom .011-.056.....	<b>11.05</b>
<b>EXL120</b>	Super Light .009-.042.....	<b>10.10</b>
<b>EXL1207</b>	Super Light 7-string .009-.054.....	<b>13.10</b>
<b>EXL1208</b>	Super Light 8-string .009-.065.....	<b>17.15</b>
<b>EKXL120</b>	Super Light/Soldered Twists .009-.042.....	<b>12.05</b>
<b>ESXL120</b>	Super Light/Double Ball End .009-.042.....	<b>26.55</b>
<b>EXL120+</b>	Super Light Plus .0095-.044.....	<b>10.10</b>
<b>EXL125</b>	Super Light Top/Regular Bottom .009-.046.....	<b>10.10</b>
<b>ESXL125</b>	Super Light Top/Reg Bottom/Dbal Ball End .009-.046.....	<b>21.65</b>
<b>EXL130</b>	Extra-Super Light .008-.038.....	<b>10.10</b>
<b>EXL130+</b>	Extra-Super Light Plus .0085-.039.....	<b>10.10</b>
<b>EXL140</b>	Light Top/Heavy Bottom .010-.052.....	<b>11.05</b>
<b>EXL1408</b>	Light Top/Heavy Bottom .010-.074.....	<b>20.70</b>
<b>EXL145</b>	Heavy .012-.054.....	<b>11.05</b>
<b>EXL148</b>	Extra Heavy .012-.060.....	<b>11.05</b>
<b>EXL150</b>	12 String/Super Light .010-.046.....	<b>15.85</b>
<b>EXL150H</b>	High Strung/Nashville Tuning .010-.026.....	<b>7.40</b>
<b>EJ20</b>	Jazz Extra-Light .010-.049.....	<b>12.05</b>
<b>EJ21</b>	Jazz Light .012-.052.....	<b>12.05</b>
<b>EJ22</b>	Jazz Medium .013-.056.....	<b>12.05</b>
<b>EXL156</b>	Electric Guitar/Bass-Fender Bass VI .024-.084.....	<b>26.55</b>
<b>XL157</b>	Baritone Medium .014-.068.....	<b>16.35</b>
<b>EXL158</b>	Baritone Light .013-.062.....	<b>15.45</b>

### Pure Nickel

<b>EPN110</b>	Regular Light .010-.045.....	<b>\$14.40</b>
<b>EPN115</b>	Blues/Jazz Rock .011-.048.....	<b>14.40</b>
<b>EPN120</b>	Super Light .009-.041.....	<b>14.40</b>
<b>EPN21</b>	Jazz Light .012-.057.....	<b>16.25</b>
<b>EPN22</b>	Jazz Medium .013-.055.....	<b>16.25</b>

## NYXL Electric Guitar

### Nickel Wound

<b>NYXL0942</b>	Super Light .009-.042.....	<b>\$19.95</b>
<b>NYXL1046</b>	Regular Light .010-.046.....	<b>19.95</b>

## Balanced Tension XL Electric Guitar & Bass

D'Addario Balanced Tension guitar set are comprised of mathematically optimized string gauge combinations, resulting in greater control and playing comfort. Combined with the distinctive bright tone of XL nickel wound strings, each set offers greater dynamic control and a more consistent feel between strings for evenly balanced bending, strumming, fretting, picking, plucking and slapping.

<b>EXL110BT</b>	Regular light .010-.046.....	<b>\$10.10</b>
<b>EXL115BT</b>	Blues/Jazz Rock .011-.050.....	<b>10.10</b>
<b>EXL120BT</b>	Super Light .009-.040.....	<b>10.10</b>

### Bass Sets

<b>EXL160BT</b>	Long .050-.120.....	<b>\$35.40</b>
<b>EXL170BT</b>	Long .045-.107.....	<b>35.40</b>
<b>EXL220BT</b>	Long .045-.095.....	<b>35.40</b>

## Electric Guitar

### Half Round Heat Treated Stainless Steel

<b>EHR310</b>	Regular Light .010-.046.....	<b>\$17.85</b>
<b>EHR320</b>	Super Light .009-.042.....	<b>17.85</b>
<b>EHR330</b>	Extra-Super Light .008-.039.....	<b>17.85</b>
<b>EHR350</b>	Jazz Light .012-.052.....	<b>21.05</b>
<b>EHR360</b>	Jazz Med .013-.056.....	<b>21.05</b>
<b>EHR370</b>	Medium .011-.047.....	<b>17.85</b>

## EXP™ Nickel Round Wound

<b>EXP110</b>	EXP Coated Regular Light .010-.046.....	<b>\$18.80</b>
<b>EXP115</b>	EXP Coated Blues/Jazz Rock .011-.049.....	<b>18.80</b>
<b>EXP120</b>	EXP Coated Super Light .009-.042.....	<b>18.80</b>
<b>EXP125</b>	EXP Coated Super Light Top/Reg. Bottom .009-.046.....	<b>18.80</b>
<b>EXP140</b>	EXP Coated Light Top/Heavy Bottom .010-.052.....	<b>18.80</b>

## Electric Guitar

### Chromes Flat Wound

<b>ECG23</b>	Extra Light .010-.048.....	<b>\$27.15</b>
<b>ECG24</b>	Jazz Light .011-.050.....	<b>27.15</b>
<b>ECG247</b>	Jazz Light .011-.065 7-string.....	<b>35.40</b>
<b>ECG25</b>	Light .012-.052.....	<b>27.15</b>
<b>ECG26</b>	Medium .013-.056.....	<b>27.15</b>

## Gypsy Jazz

D'Addarop Gypsy Jazz strings are specially designed for the "Django" style. Silverplated copper is wound on a high carbon steel core, delivering a warm, projecting tone, optimal for any Gypsy Jazz style guitar.



<b>EJ83L</b>	Gypsy Jazz Ball End Light .010-.044.....	<b>\$16.90</b>
<b>EJ83M</b>	Gypsy Jazz Ball End Medium .011-.045.....	<b>16.90</b>
<b>EJ84L</b>	Gypsy Jazz Loop End Light .010-.044.....	<b>16.90</b>
<b>EJ84M</b>	Gypsy Jazz Loop End Medium .011-.045.....	<b>16.90</b>

## EXP Acoustic Guitar

### Coated Phosphor Bronze Round Wound

<b>EXP15</b>	EXP Coated PB Extra Light .010-.047.....	<b>\$24.40</b>
<b>EXP26</b>	EXP Coated PB Custom Light .011-.052.....	<b>24.40</b>
<b>EXP16</b>	EXP Coated PB Light .012-.053.....	<b>24.40</b>
<b>EXP19</b>	EXP Coated Bluegrass .012-.056.....	<b>24.40</b>
<b>EXP17</b>	EXP Coated PB Medium .013-.056.....	<b>24.40</b>
<b>EXP42</b>	EXP Coated PB Resophonic Guitar .016-.056.....	<b>24.40</b>
<b>EXP38</b>	EXP Coated PB 12-String Light .010-.047.....	<b>40.35</b>
<b>EXP23</b>	EXP Coated PB Baritone Guitar .016-.070.....	<b>28.20</b>

## Acoustic Guitar

### Phosphor Bronze Round Wound

Introduced to stringmaking by D'Addario in 1974, phosphor bronze has become synonymous with great, long-lasting string tone.

<b>EJ15</b>	Extra Light .010-.047.....	<b>\$13.15</b>
<b>EJ26</b>	Custom Light .011-.052.....	<b>13.15</b>
<b>EJ16</b>	Light .012-.053.....	<b>13.15</b>
<b>EJ17</b>	Medium .013-.056.....	<b>13.15</b>
<b>EJ18</b>	Heavy .014-.059.....	<b>13.15</b>
<b>EJ19</b>	Bluegrass: Light Top/Medium Bottom .012-.056.....	<b>13.15</b>
<b>EJ24</b>	True Medium .013-.056.....	<b>13.15</b>
<b>EJ38H</b>	High Strung/Nashville Tuning .10-.27.....	<b>9.40</b>
<b>EJ37</b>	12-String: Med Top/Heavy Bottom .12-.54.....	<b>22.55</b>
<b>EJ38</b>	12-String/Light .010-.047.....	<b>20.70</b>
<b>EJ39</b>	12-String/Medium .012-.052.....	<b>20.70</b>
<b>EJ41</b>	12-String/Extra Light .009-.045.....	<b>20.70</b>
<b>EJ42</b>	Resophonic Guitar .016-.056.....	<b>13.15</b>

www.daddario.com

# D'ADDARIO STRINGS

## Acoustic Guitar

### Flat Tops Semi-Flat Phosphor Bronze

D'Addario phosphor bronze strings in a semi-flat format. Three polishing steps produce a smooth, flattened playing surface without sacrificing the tone and sustain associated with phosphor bronze strings.



<b>EFT13</b>	Resophonic Guitar .016-.056.....	<b>\$26.55</b>
<b>EFT15</b>	Extra Light .010-.047.....	<b>26.55</b>
<b>EFT16</b>	Regular Light .012-.053.....	<b>26.55</b>
<b>EFT17</b>	Medium .013-.056.....	<b>26.55</b>

## EXP Acoustic Guitar

### Coated 80/20 Bronze Round Wound

We've added our ultra-fine EXP Coating to the 80/20 bronze outer wrap wire to create the brightest, longest lasting acoustic guitar strings on the market.



<b>EXP10</b>	EXP Coated 80/20 Extra Light .010-.047.....	<b>\$21.65</b>
<b>EXP11</b>	EXP Coated 80/20 Light .012-.053.....	<b>21.65</b>
<b>EXP12</b>	EXP Coated 80/20 Medium .013-.056.....	<b>21.65</b>
<b>EXP13</b>	EXP Coated 80/20 Custom Light .011-.052.....	<b>21.65</b>
<b>EXP14</b>	EXP Coated 80/20 Blue Grass .012-.056.....	<b>21.65</b>
<b>EXP36</b>	EXP Coated 80/20 12-String .010-.047.....	<b>34.20</b>

## Acoustic Guitar

### 80/20 Bronze Round Wound

D'Addario pioneered the use of 80/20 bronze (sometimes called brass) for use on acoustic guitar strings. Bright and crisp sounding, they are still a popular choice for stage and studio professionals.



<b>EJ10</b>	Extra Light .010-.047.....	<b>\$10.35</b>
<b>EJ11</b>	Light .012-.053.....	<b>10.35</b>
<b>EJ12</b>	Medium .013-.056.....	<b>10.35</b>
<b>EJ13</b>	Custom Light .011-.052.....	<b>10.35</b>
<b>EJ14</b>	Bluegrass: Light Top/Medium Bottom .012-.056.....	<b>10.35</b>
<b>EJ36</b>	12-String/Light .010-.047.....	<b>16.45</b>

## Electric Guitar/Bass

### Nickel Round Wound

30" Scale. A 6-string guitar/bass is normally played with a pick and is tuned like a guitar except at an octave lower.



<b>EXL156</b>	Electric Guitar/Bass-Fender Bass VI .024-.084.....	<b>\$26.55</b>
---------------	--	----------------

## Electric Guitar

### XL Prosteels Round Wound

Prosteels are D'Addario's brightest and most magnetic guitar strings. A specialized alloy delivers harmonically rich, brilliant, high-end and increased crunch and sustain.



<b>EPS510</b>	Regular Light .010-.046.....	<b>\$11.20</b>
<b>EPS520</b>	Super Light .009-.042.....	<b>11.20</b>
<b>EPS530</b>	Extra-Super Light .008-.038.....	<b>11.20</b>
<b>EPS540</b>	Light Top/Heavy Bottom.....	<b>11.85</b>
<b>EPS590</b>	Jazz Light .012-.052.....	<b>13.45</b>
<b>EPS600</b>	Jazz Medium .013-.056.....	<b>13.45</b>
<b>PS490</b>	E-9th Pedal Steel Tuning.....	<b>19.10</b>
<b>PS500</b>	C-6th Pedal Steel Tuning.....	<b>21.65</b>

## Classical Guitar

### Pro•Arté



<b>EJ44C</b>	Long Lasting Composite Polymer/X-Hard.....	<b>\$24.30</b>
<b>EJ44</b>	Silver/Clear/Extra-Hard.....	<b>16.05</b>
<b>EJ44LP</b>	Lightly Polished Silver/Clear/X-Hard.....	<b>36.75</b>
<b>EJ45C</b>	Long Lasting Composite Polymer/Normal.....	<b>24.30</b>
<b>EJ45</b>	Silver/Clear/Normal.....	<b>16.05</b>
<b>EJ45LP</b>	Lightly Polished Silver/Clear/Normal.....	<b>36.75</b>
<b>EJ46C</b>	Long Lasting Composite Polymer/Hard.....	<b>24.30</b>
<b>EJ46</b>	Silver/Clear/Hard.....	<b>16.05</b>
<b>EJ46LP</b>	Lightly Polished Silver/Clear/Hard.....	<b>36.75</b>
<b>EJ43</b>	Silver/Clear/Light.....	<b>16.05</b>
<b>EJ47</b>	Gold/Clear/Normal.....	<b>16.05</b>
<b>EJ48</b>	80/20 Bronze/Clear/Hard.....	<b>16.05</b>
<b>EJ49</b>	Silver/Black/Normal.....	<b>16.05</b>
<b>EJ50</b>	Silver/Black/Hard.....	<b>16.05</b>
<b>EJ51</b>	Polished Basses/Hard.....	<b>50.10</b>
<b>EJ52</b>	Alto Guitar Silver/Clear/Normal.....	<b>13.35</b>
<b>EJ25C</b>	Composite Flamenco/Clear/Normal.....	<b>18.80</b>
<b>EJ25B</b>	Composite Flamenco/Black/Normal.....	<b>18.80</b>

## EXP Classical

<b>EXP44</b>	EXP Coated Silver Wound/Extra-Hard.....	<b>\$22.55</b>
<b>EXP45</b>	EXP Coated Silver Wound/Normal.....	<b>22.55</b>
<b>EXP46</b>	EXP Coated Silver Wound/Hard.....	<b>22.55</b>

## Pro•Arté™ Dynacore Strings

Pro•Arté DynaCore sets are constructed using our exclusive multifilament stranded core material with a revolutionary winding technique. The result is a truly unique and contemporary tone...rich, round and full with dramatically improved string life, tuning stability and consistency. These sets are complimented by titanium trebles (bright and projecting) for optimal tonal balance.



<b>EJ45TT</b>	Composite / Titanium / Normal.....	<b>\$24.30</b>
<b>EJ44TT</b>	Composite / Titanium / Extra-Hard.....	<b>24.30</b>
<b>EJ46TT</b>	Composite / Titanium / Hard.....	<b>24.30</b>

## Classical Guitar

### D'Addario Classics

<b>EJ29</b>	Silver Wound/Rectified Clear Nylon - Moderate.....	<b>\$15.99</b>
<b>EJ30</b>	Silver Wound/Rectified Clear Nylon - Normal.....	<b>16.05</b>
<b>EJ31</b>	Silver Wound/Rectified Clear Nylon - Hard.....	<b>16.05</b>
<b>EJ27N</b>	Silver Wound/Clear Nylon - Normal - 3/4, 1/2 Also.....	<b>10.75</b>
<b>EJ27H</b>	Silver Wound/Clear Nylon - Hard Tension.....	<b>10.75</b>

## Folk Guitar

### Folk Nylon

Folk nylon strings are high-quality nylon guitar strings with **ball ends**.



<b>EJ32</b>	Silver Wound/Black nylon trebles.....	<b>\$16.55</b>
<b>EJ33</b>	Gold Wound/Clear nylon trebles.....	<b>16.55</b>
<b>EJ34</b>	Gold Wound/Black nylon trebles.....	<b>16.55</b>

## Folk Guitar

### Silk & Steel

Silk & steel strings make for easier fingering and mel-low tone. Excellent on smaller body acoustic guitars.



<b>EJ35</b>	12-String/Silverplated Wound.....	<b>\$26.55</b>
<b>EJ40</b>	Silverplated Wound.....	<b>20.40</b>

# D'ADDARIO STRINGS

## EXP Electric Bass

### Coated Nickel Round Wound

The ultra-fine layer of EXP Coating, bonded to the outer nickelplated steel wrap wire, provides a barrier against corrosion and wear and keeps strings sounding fresh and bright far longer than traditional bass strings.



ITEM #	SCALE	GAUGES	RETAIL
<b>EXP160</b>	Long	.050 .070 .085 .105	<b>\$56.35</b>
<b>EXP165</b>	Long	.045 .065 .085 .105	<b>\$6.35</b>
<b>EXP170</b>	Long	.045 .065 .080 .100	<b>\$6.35</b>
<b>EXP170SL</b>	Super	.045 .065 .080 .100	<b>\$9.80</b>
<b>EXP1705</b>	5-String Long	.045 .065 .080 .100 .130	<b>\$6.80</b>
<b>EXP1705SL</b>	5-String Super Long	.045 .065 .080 .100 .130	<b>\$9.00</b>
<b>EXP220</b>	Long	.040 .060 .075 .095	<b>\$5.20</b>

## XL™ Nylon Tape Wound

<b>ETB92</b>	Long	.050 .065 .085 .105	<b>\$7.90</b>
<b>ETB92S</b>	Short	.050 .065 .085 .105	<b>\$7.90</b>
<b>ETB92M</b>	Medium	.050 .065 .085 .105	<b>\$7.90</b>
<b>ETB925</b>	5-String/Long	.050 .065 .085 .105 .135	<b>\$9.30</b>

## Electric Bass

### XL Nickel Round Wound

Nickel-plated steel delivers excellent magnetic output while providing a smooth, comfortable surface that reduces premature fret wear. XL electric bass strings are known for their distinctive bright sound and excellent intonation.



ITEM #	SCALE	GAUGES	RETAIL
<b>EXL160</b>	Long	.050 .070 .085 .105	<b>\$35.40</b>
<b>EXL160SL</b>	Super Long	.050 .070 .085 .105	<b>\$9.40</b>
<b>EXL160S</b>	Short	.050 .070 .085 .105	<b>\$5.40</b>
<b>EXL160M</b>	Medium	.050 .070 .085 .105	<b>\$5.40</b>
<b>EXL1605</b>	5-String/Long	.050 .070 .085 .105 .135	<b>\$6.20</b>
<b>ESXL160</b>	Double Ball/Long	.050 .070 .085 .105	<b>\$1.10</b>
<b>EXL165</b>	Long	.045 .065 .085 .105	<b>\$5.40</b>
<b>EXL165SL</b>	Super Long	.045 .065 .085 .105	<b>\$9.40</b>
<b>EXL1655</b>	5-String/Long	.045 .065 .085 .105 .135	<b>\$6.20</b>
<b>EXL1656</b>	6-String/Long	.032 .045 .065 .085 .105 .135	<b>\$1.10</b>
<b>EXL170</b>	Long	.045 .065 .080 .100	<b>\$5.40</b>
<b>EXL170SL</b>	Super Long	.045 .065 .080 .100	<b>\$9.40</b>
<b>EXL170S</b>	Short	.045 .065 .080 .100	<b>\$5.40</b>
<b>EXL170M</b>	Medium	.045 .065 .080 .100	<b>\$5.40</b>
<b>EXL1705</b>	5-String/Long	.045 .065 .080 .100 .130	<b>\$6.20</b>
<b>EXL1705SL</b>	5-String/Super Long	.045 .065 .080 .100 .130	<b>\$1.10</b>
<b>EXL1706</b>	6-String/Long	.032 .045 .065 .080 .100 .130	<b>\$1.20</b>
<b>EXL1708</b>	8-String/Long	.018 .028 .040 .050	
		.045 .065 .080 .100	<b>\$8.20</b>
<b>EXL17012</b>	12-String/Long	.045 .018P .018P .065 .025W .025W	
		.080 .035 .035 .100 .045 .045	<b>\$7.65</b>
<b>ESXL170</b>	Double Ball/Long	.045 .065 .080 .100	<b>\$1.10</b>
<b>EXL180</b>	Long	.035 .055 .075 .095	<b>\$5.40</b>
<b>EXL190</b>	Long	.040 .060 .080 .100	<b>\$5.40</b>
<b>EXL220</b>	Long	.040 .060 .075 .095	<b>\$5.40</b>
<b>EXL220S</b>	Short	.040 .060 .075 .095	<b>\$5.40</b>
<b>EXL220SL</b>	Super Long	.040 .060 .075 .095	<b>\$9.40</b>
<b>EXL220M</b>	Medium	.040 .060 .075 .095	<b>\$5.40</b>
<b>EXL2205</b>	5-String/Long	.040 .060 .075 .095 .125	<b>\$6.20</b>
<b>EXL230</b>	Long	.055 .075 .090 .110	<b>\$5.40</b>
<b>EXL280</b>	Piccolo/Long	.020 .032 .042 .052	<b>\$9.50</b>

## Flex Steels Bass Sets

A monumental breakthrough in bass string technology, FlexSteels bass strings deliver the unique combination of a flexible feel coupled with a coveted deep and round tone with just the right amount of punch and bite. A harmonic-rich steel alloy with precisely formulated core-to-wrap diameters wound to the most precise specifications deliver this singular tone and feel with unsurpassed consistency and extra-long string life.

<b>EFX125</b>	Set Long Scale 4-String, 45-105	<b>\$44.90</b>
<b>EFX160</b>	Set Long Scale 4-String, 50-105	<b>\$4.90</b>
<b>EFX220</b>	Set Long Scale 4-String, 40-95	<b>\$4.90</b>
<b>EFX170</b>	Set Long Scale 4-String, 45-100	<b>\$4.90</b>
<b>EFX1705SL</b>	Set Super Long Scale 5-String, 45-130	<b>\$3.90</b>
<b>EFX170SL</b>	Set Long Scale 5-String, 45-100	<b>\$8.65</b>
<b>EFX1706</b>	Set Long Scale 6-String, 32-130	<b>\$3.90</b>
<b>EFX1705</b>	Set Long Scale 5-String, 45-130	<b>\$4.90</b>

## Acoustic Bass

### EXP Coated & Phosphor Bronze

Phosphor bronze is popular in the acoustic market for its resilient tone and boomy bass. Now available in EXP Coated!

ITEM #	SCALE	GAUGES	RETAIL
<b>EXPPBB170</b>	Long	.045 .065 .080 .100	<b>\$73.60</b>
<b>EPBB170</b>	Long	.045 .065 .080 .100	<b>\$6.20</b>
<b>EPBB1705</b>	5 String/Long	.045 .065 .080 .100 .130	<b>\$7.15</b>

## Electric Bass Twin Packs

### EXL Bass Twin Packs

D'Addario's Bass Twin Packs are two complete sets in one box, with each set packaged in a Corrosion Intercept bag for long life.

ITEM #	SCALE	RETAIL
<b>EXL160TP</b>	2 Sets EXL Bass Reg Long	<b>\$56.50</b>
<b>EXL165TP</b>	2 Sets EXL Bass Soft/Reg	<b>\$6.50</b>
<b>EXL170TP</b>	2 Sets EXL Bass Soft Long	<b>\$2.90</b>
<b>EXL1705TP</b>	2 Sets EXL-5 String Bass Soft Long	<b>\$9.50</b>
<b>EXL220TP</b>	2 Sets EXL-5 Bass Long	<b>\$6.50</b>

## Electric Bass

### XL Chromes Flat Wound

Complex combinations of interlocking underwindings on a hex core build a foundation for the delicate outer ribbon winding. Each string is ground and polished to produce an incredibly smooth surface.

<b>ECB80</b>	Long	.040 .060 .075 .095	<b>\$64.20</b>
<b>ECB80SL</b>	Super Long	.040 .060 .075 .095	<b>\$64.20</b>
<b>ECB81</b>	Long	.045 .065 .080 .100	<b>\$64.20</b>
<b>ECB81M</b>	Medium	.045 .065 .080 .100	<b>\$64.20</b>
<b>ECB81S</b>	Short	.045 .065 .080 .100	<b>\$64.20</b>
<b>ECB84</b>	Custom Lite	.040 .065 .080 .100	<b>\$64.20</b>
<b>ECB81SL</b>	Super Long	.045 .065 .080 .100	<b>\$73.85</b>
<b>ECB815</b>	5-String/Long	.045 .065 .080 .100 .132	<b>\$90.40</b>
<b>ECB815SL</b>	5-String/Super Long	.045 .065 .080 .100 .132	<b>\$101.10</b>
<b>ECB82</b>	Long	.050 .070 .085 .105	<b>\$64.20</b>

## Electric Bass

### Half Round™ Heat Treated Nickel

Half Round bass strings are round wound with pure nickel, then precision ground, leaving the outer surface smooth.

ITEM #	SCALE	GAUGES	RETAIL
<b>ENR70</b>	Long	.040 .060 .075 .095	<b>\$56.10</b>
<b>ENR71</b>	Long	.045 .065 .080 .100	<b>\$6.10</b>
<b>ENR71SL</b>	Super Long	.045 .065 .080 .100	<b>\$64.10</b>
<b>ENR71S</b>	Short	.045 .065 .080 .100	<b>\$6.10</b>
<b>ENR71M</b>	Medium	.045 .065 .080 .100	<b>\$6.10</b>
<b>ENR715</b>	5-string/Long	.045 .065 .080 .100 .130	<b>\$77.55</b>
<b>ENR715SL</b>	5-string/Super Long	.045 .065 .080 .100 .130	<b>\$83.75</b>
<b>ENR716</b>	6-string/Long	.030 .045 .065 .080 .100 .130	<b>\$83.75</b>
<b>ENR72</b>	Long	.050 .070 .085 .105	<b>\$6.10</b>
<b>ENR73</b>	Long	.055 .075 .090 .110	<b>\$6.10</b>



# D'ADDARIO STRINGS

## Ukulele

D'Addario ukulele sets are available in a wide variety of gauges for all popular ukulele instrument sizes and tunings. Each set is made from the finest quality nylon, aluminum and silverplated copper materials ensuring optimal tone and guaranteed to have absolutely perfect intonation each time.



<b>EJ88T</b>	Nyltech Tenor Ukulele .....	<b>\$12.85</b>
<b>EJ88S</b>	Nyltech Soprano Ukulele .....	<b>11.35</b>
<b>EJ88C</b>	Nyltech Concert Ukulele .....	<b>11.35</b>
<b>EJ88B</b>	Nyltech Baritone Ukulele .....	<b>14.20</b>
<b>J65</b>	Soprano Ukulele .....	<b>8.55</b>
<b>J53</b>	Ukulele/Hawaiian-Concert Blk/Nylon .....	<b>8.55</b>
<b>J54</b>	Tenor Ukulele/Hawaiian Blk/Nylon.....	<b>9.30</b>
<b>J68</b>	Baritone Ukulele .....	<b>10.65</b>
<b>J71</b>	Pro•Arté Tenor Ukulele.....	<b>8.55</b>
<b>J92</b>	Pro•Arté Concert Ukulele .....	<b>8.55</b>
<b>EJ87S</b>	Titanium Soprano Ukulele .....	<b>8.40</b>
<b>EJ87T</b>	Titanium Tenor Ukulele .....	<b>8.85</b>
<b>EJ87C</b>	Titanium Concert Ukulele.....	<b>8.40</b>
<b>EJ87B</b>	Titanium Baritone Ukulele .....	<b>10.05</b>

## ProSteels™

### XL ProSteels™ Round Wound

ProSteels are D'Addario's brightest and most magnetic bass strings. A specialized alloy delivers harmonically rich, brilliant high-end coupled with deep, tight lows that work in tandem to create the "piano tone" steel players crave. ProSteels are the new sounds of steel!



ITEM #	SCALE	GAUGES	RETAIL
<b>EPS160</b>	Long	.050 .070 .085 .105 .....	<b>\$35.40</b>
<b>EPS1605</b>	5-String/Long	.050 .070 .085 .105 .135 .....	<b>46.20</b>
<b>EPS160SL</b>	Super Long	.050 .070 .085 .105 .....	<b>39.40</b>
<b>EPS165</b>	Long	.045 .065 .085 .105 .....	<b>35.40</b>
<b>EPS1655</b>	5-String/Long	.045 .065 .085 .105 .135 .....	<b>47.25</b>
<b>EPS165SL</b>	Super Long	.045 .065 .085 .105 .....	<b>39.30</b>
<b>EPS170</b>	Long	.045 .065 .080 .100 .....	<b>35.40</b>
<b>EPS1705</b>	5-String/Long	.045 .065 .080 .100 .130 .....	<b>47.25</b>
<b>EPS1706</b>	6-String/Long	.030 .045 .065 .080 .100 .130 .....	<b>51.20</b>
<b>EPS170M</b>	Medium	.045 .065 .080 .100 .....	<b>35.40</b>
<b>EPS170S</b>	Short	.045 .065 .080 .100 .....	<b>35.40</b>
<b>EPS170SL</b>	Super Long	.045 .065 .080 .100 .....	<b>39.30</b>
<b>EPS1705SL</b>	5-String/Super Long	.045 .065 .080 .100 .130 .....	<b>47.85</b>
<b>EPS1706SL</b>	6-String/Super Long	.030 .045 .065 .080 .100 .130 .....	<b>52.45</b>
<b>EPS180</b>	Long	.035 .055 .075 .095 .....	<b>35.40</b>
<b>EPS190</b>	Long	.040 .060 .080 .100 .....	<b>35.40</b>
<b>EPS220</b>	Long	.040 .060 .075 .095 .....	<b>35.40</b>
<b>EPS2205</b>	5-String/Long	.040 .060 .075 .095 .125 .....	<b>47.25</b>
<b>EPS230</b>	Long	.055 .075 .090 .110 .....	<b>35.40</b>

## EXP Reds

EXP Reds use a proprietary outer wrap wire made of copper coated steel which is then micro-coated utilizing D'Addario's EXP technology. Like a standard electric bass guitar string, the outer wire is highly magnetic, but the copper coating imparts a more "acoustic" tone on basses with magnetic and/or piezo pickups.



<b>EXPR160</b>	Long	.050 .070 .085 .105 .....	<b>\$56.35</b>
<b>EXPR165</b>	Long	.045 .065 .085 .105 .....	<b>56.35</b>
<b>EXPR170</b>	Long	.045 .065 .080 .100 .....	<b>56.35</b>

## Mandolin Family

**Mandolin, Mandola, Mandocello & Mandobass**  
D'Addario mandolin family strings are the choice of David Grisman, Mike Marshall, Ricky Skaggs, Ronnie McCoury, Doyle Lawson and more.



<b>J62</b>	Mandolin - 80/20 Bronze .....	<b>\$12.85</b>
<b>J67</b>	Mandolin/Nickel .....	<b>12.80</b>
<b>J74</b>	Mandolin/Phosphor Bronze - Medium .....	<b>13.10</b>
<b>J73</b>	Mandolin/Phosphor Bronze - Light.....	<b>13.10</b>
<b>EXP74</b>	Mandolin/EXP Coated Phosphor Bronze - Medium .....	<b>24.40</b>
<b>EXP75</b>	Mandolin/EXP Coated Bronze - Medium/Heavy .....	<b>24.40</b>
<b>EXP77</b>	Mandolin/EXP Coated 80/20 Bronze - Medium .....	<b>20.70</b>
<b>J574</b>	Mandolin/Stainless Steel - Medium .....	<b>12.80</b>
<b>J80</b>	Octave Mandolin/Phosphor Bronze .....	<b>18.90</b>
<b>EJ70</b>	Mandolin/Phosphor Bronze Ball End.....	<b>13.50</b>
<b>FT74</b>	Mandolin/Flat Tops/Phosphor Bronze .....	<b>32.10</b>
<b>FW74</b>	Mandolin/ <b>Flat Wound</b> /Medium .....	<b>28.60</b>
<b>J75</b>	Mandolin/Phosphor Bronze - Medium/Heavy .....	<b>13.10</b>
<b>J76</b>	Mandola/Phosphor Bronze .....	<b>18.90</b>
<b>J72</b>	Mandola/Phosphor Bronze - Light .....	<b>18.90</b>
<b>FT76</b>	Mandola/Flat Tops/Phosphor Bronze .....	<b>42.00</b>
<b>J78</b>	Mandocello/Phosphor Bronze .....	<b>32.75</b>
<b>J79</b>	Mandobass/Copper Coated Steel .....	<b>47.40</b>

## Banjo

### 5-String and Tenor

With a strong selection of gauges and alloys, D'Addario banjo strings have become the choice of players.



<b>J60</b>	5-String/Light/Nickel.....	<b>\$7.70</b>
<b>JS60</b>	5-String/Light/Stainless Steel.....	<b>7.70</b>
<b>J61</b>	5-String/Medium/Nickel .....	<b>7.70</b>
<b>J60+</b>	5-String Banjo/Light Plus/Nickel.....	<b>7.70</b>
<b>J55</b>	5-String Banjo/Medium/Phos Bronze.....	<b>7.70</b>
<b>J57</b>	5-String Banjo/Custom Medium/Nickel.....	<b>7.70</b>
<b>JS57</b>	5-String/Medium/Stainless Steel .....	<b>7.70</b>
<b>J63</b>	Tenor Banjo/Nickel .....	<b>7.70</b>
<b>J631</b>	Irish Tenor Banjo .....	<b>7.70</b>
<b>J69</b>	5-String/Light/Phosphor Bronze .....	<b>7.70</b>
<b>J69B</b>	5-String/ <b>Ball End</b> /Phosphor Bronze .....	<b>7.70</b>

## Other Sets

### Dulcimer, Tenor Guitar, Oud, Bouzouki, Cuatro, Fiddle



<b>J64</b>	Dulcimer/4-String .....	<b>\$ 6.30</b>
<b>J66</b>	Tenor Guitar .....	<b>7.00</b>
<b>J85</b>	Bajo Quinto.....	<b>29.85</b>
<b>J86</b>	Bajo Sexto .....	<b>39.80</b>
<b>J81</b>	Bouzouki, Irish .....	<b>12.95</b>
<b>J89</b>	Cretan Lyra .....	<b>20.35</b>
<b>J93</b>	Cavaquinho .....	<b>6.45</b>
<b>J94</b>	Requinto.....	<b>14.00</b>
<b>J95</b>	Oud/11-String .....	<b>25.00</b>
<b>J96</b>	Cuatro-Puerto Rico 10-String.....	<b>27.00</b>
<b>J97</b>	Bouzouki, Greek 8-String .....	<b>11.90</b>
<b>J98</b>	Cuatro-Venezuela.....	<b>5.95</b>
<b>J976</b>	6-String Bouzouki - Greek .....	<b>9.80</b>
<b>J987</b>	6-String Baglama - Tzouras.....	<b>9.80</b>

# D'ADDARIO STRINGS



PL007	.....	\$1.25
PL008	.....	1.25
PL0085	.....	1.25
PL009	.....	1.25
PL0095	.....	1.25
PL010	.....	1.25
PL0105	.....	1.25
PL011	.....	1.25
PL0115	.....	1.25
PL012	.....	1.25
PL0125	.....	1.25
PL013	.....	1.25
PL0135	.....	1.25
PL01355	.....	1.25
PL014	.....	1.25
PL015	.....	1.25
PL016	.....	1.25
PL017	.....	1.25
PL018	.....	1.25
PL019	.....	1.30
PL020	.....	1.30
PL022	.....	1.30
PL024	.....	1.30
PL026	.....	1.30

Acoustic Guitar  
80/20 Bronze  
Round Wound



BW020	.....	\$2.55
BW021	.....	2.55
BW022	.....	2.55
BW023	.....	2.55
BW024	.....	2.55
BW025	.....	2.55
BW026	.....	2.55
BW027	.....	2.55
BW029	.....	2.90
BW030	.....	2.90
BW032	.....	2.90
BW034	.....	2.90
BW035	.....	2.90
BW036	.....	2.90
BW039	.....	2.90
BW042	.....	2.90
BW045	.....	2.90
BW047	.....	2.90
BW049	.....	3.20
BW052	.....	3.20
BW053	.....	3.20
BW056	.....	3.20
BW059	.....	3.20



Long Scale

XLB018p	.....	\$ 4.30
XLB020p	.....	4.30
XLB028w	.....	6.40
XLB032	.....	7.20
XLB035	.....	7.20
XLB040	.....	7.20
XLB042	.....	7.20
XLB045	.....	7.20
XLB050	.....	7.20
XLB052	.....	7.20
XLB055	.....	7.20
XLB060	.....	8.70
XLB065	.....	8.70
XLB067	.....	8.70
XLB070	.....	8.70
XLB075	.....	9.25
XLB080	.....	9.25
XLB085	.....	9.25
XLB090	.....	11.20
XLB095	.....	11.20
XLB100	.....	11.20
XLB105	.....	11.20
XLB107	.....	11.20
XLB110	.....	11.20
XLB120	.....	12.50
XLB125	.....	12.50
XLB130	.....	12.50
XLB135	.....	12.50
XLB145	.....	12.50

Acoustic Guitar  
EXP Coated  
Phosphor Bronze  
Round Wound

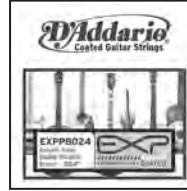

EXPPB020	.....	\$5.30
EXPPB022	.....	5.30
EXPPB023	.....	5.30
EXPPB024	.....	5.30
EXPPB025	.....	5.30
EXPPB026	.....	5.30
EXPPB027	.....	5.30
EXPPB028	.....	5.80
EXPPB029	.....	5.80
EXPPB030	.....	5.80
EXPPB032	.....	5.80
EXPPB034	.....	5.80
EXPPB035	.....	5.80
EXPPB036	.....	5.80
EXPPB039	.....	6.25
EXPPB042	.....	6.25
EXPPB045	.....	6.25
EXPPB047	.....	6.25
EXPPB049	.....	6.70
EXPPB052	.....	6.70
EXPPB053	.....	6.70
EXPPB056	.....	6.70
EXPPB059	.....	6.70

Acoustic Guitar  
EXP Coated  
80/20 Bronze  
Round Wound



EXPBW020	.....	\$4.40
EXPBW022	.....	4.40
EXPBW023	.....	4.40
EXPBW024	.....	4.40
EXPBW025	.....	4.40
EXPBW026	.....	4.40
EXPBW027	.....	4.40
EXPBW030	.....	5.00
EXPBW032	.....	5.00
EXPBW035	.....	5.00
EXPBW036	.....	5.00
EXPBW039	.....	5.50
EXPBW042	.....	5.50
EXPBW045	.....	5.50
EXPBW047	.....	5.50
EXPBW052	.....	6.05
EXPBW053	.....	6.05
EXPBW056	.....	6.05
EXPBW059	.....	6.05



NW017	.....	\$2.40
NW018	.....	2.40
NW019	.....	2.40
NW020	.....	2.40
NW021	.....	2.40
NW022	.....	2.40
NW024	.....	2.40
NW025	.....	2.40
NW026	.....	2.40
NW028	.....	2.55
NW030	.....	2.55
NW032	.....	2.55
NW034	.....	2.55
NW036	.....	2.55
NW037	.....	2.95
NW038	.....	2.95
NW039	.....	2.95
NW040	.....	2.95
NW042	.....	2.95
NW044	.....	2.95
NW046	.....	2.95
NW048	.....	2.95
NW049	.....	2.95
NW050	.....	2.95
NW052	.....	3.50
NW054	.....	3.50
NW056	.....	3.50
NW059	.....	3.50

Acoustic Guitar  
Phosphor Bronze  
Round Wound



PB020	.....	\$2.75
PB021	.....	2.75
PB022	.....	2.75
PB023	.....	2.75
PB024	.....	2.75
PB025	.....	2.75
PB026	.....	2.75
PB027	.....	2.75
PB028	.....	3.45
PB029	.....	3.45
PB030	.....	3.45
PB032	.....	3.45
PB034	.....	3.45
PB035	.....	3.45
PB036	.....	3.45
PB039	.....	3.45
PB042	.....	3.45
PB045	.....	3.45
PB047	.....	3.45
PB049	.....	3.85
PB052	.....	3.85
PB053	.....	3.85
PB056	.....	3.85
PB059	.....	3.85
PB060	.....	3.85
PB062	.....	4.30
PB064	.....	4.30
PB066	.....	4.30
PB070	.....	7.15

## Single String Bins/Display

- PL100 300 plain steel strings in diameters from .007-.026 for acoustic or electric guitars.....\$312.85
- NW100 Nickel Wound String Kit - 138 strings in diameters from .017-.059.....312.35

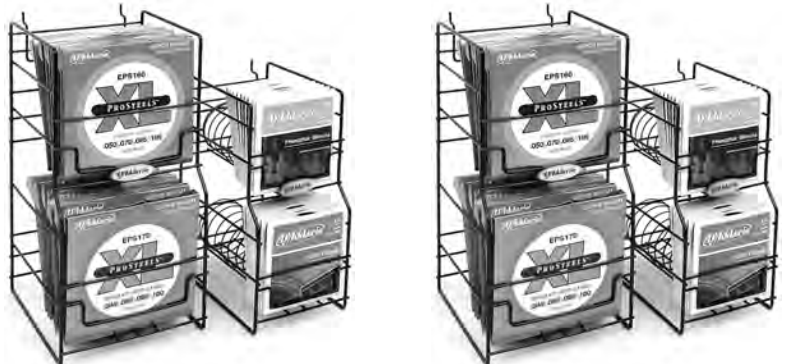

## Spring-Loaded String Set Wall Displays

- EXL30 30-sets of XL electric guitar strings:  
15 EXL110 and 15 EXL120 contained in spring loaded display.....\$302.95
- EPA30 30-sets of Pro-Arté classical guitar strings  
15 EJ45 and 15 EJ46 contained in spring loaded display.....480.45
- EPB30 30-sets of Phosphor Bronze guitar strings  
15 EJ16 and 15 EJ17 contained in spring loaded display.....393.25
- EXLB15 15-sets of XL bass strings:  
10 EXL170 and 5 EXL160 contained in spring loaded displays.....511.40

# PEAVEY® STRING SETS



## STRINGS

### ELECTRIC GUITAR STRINGS

<b>00579450</b>	Balanced 9s Nickel Wound Elements® (9-42).....	<b>\$7.99</b>
<b>00579470</b>	Balanced 10s Nickel Wound Elements (10-46).....	<b>7.99</b>
<b>00577930</b>	Balanced 11s Nickel Wound Elements (11-48).....	<b>7.99</b>
<b>00577940</b>	Balanced 12s Nickel Wound Elements (12-56).....	<b>7.99</b>
<b>00579480</b>	Balanced 9s Stainless Steel Elements (9-46).....	<b>8.69</b>
<b>00578130</b>	Balanced 10s Stainless Steel Elements (10-52).....	<b>8.69</b>

Peavey Elements include an extra E string at no extra charge.

### ACOUSTIC GUITAR STRINGS

<b>00578640</b>	Phosphor Bronze-Balanced 12s (12-053).....	<b>\$7.99</b>
-----------------	--	---------------

### BASS GUITAR STRINGS

<b>00379260</b>	Cirrus™ Bass String 4XL (045-105).....	<b>\$29.99</b>
<b>00379270</b>	Cirrus Bass String 5XL (045-125).....	<b>32.49</b>
<b>00379280</b>	Cirrus Bass String 6XL (036-125).....	<b>43.19</b>

### JACK DANIEL'S STRINGS

<b>00590680</b>	Jack Daniel's Lynchburg Premium Phosphor Bronze Acoustic 10s.....	<b>\$13.99</b>
<b>00590560</b>	Jack Daniel's Lynchburg Premium Phosphor Bronze Acoustic 11s.....	<b>13.99</b>
<b>00590570</b>	Jack Daniel's Lynchburg Premium Phosphor Bronze Acoustic 12s.....	<b>13.99</b>
<b>00590540</b>	Jack Daniel's Nickel Wound Premium Electric 9s.....	<b>12.99</b>
<b>00590550</b>	Jack Daniel's Nickel Wound Premium Electric 10s.....	<b>12.99</b>

## DARCO STRINGS

### FUNKY ELECTRIC

<b>D9150</b>	011-049.....	<b>\$10.99</b>
<b>D9200</b>	010-046.....	<b>10.99</b>
<b>D9300</b>	009-042.....	<b>10.99</b>
<b>D9400</b>	008-039.....	<b>10.99</b>
<b>D9100</b>	Jazz Lite.....	<b>10.99</b>
<b>D9600</b>	010-052.....	<b>10.99</b>
<b>D9900L</b>	Bass, 40-95.....	<b>40.99</b>
<b>D9700L</b>	Bass, 45-105.....	<b>46.99</b>
<b>D9500L</b>	Bass, 50-105.....	<b>46.99</b>
<b>D9705L</b>	5 Stg. Bass, 45-125.....	<b>61.49</b>

### PHOSPHOR BRONZE ACOUSTIC

<b>D2100</b>	Xlt.....	<b>\$11.99</b>
<b>D2200</b>	Lite.....	<b>11.99</b>
<b>D2300</b>	Med.....	<b>11.99</b>
<b>D2000</b>	12 Stg. Xlt.....	<b>19.49</b>

### BRONZE ACOUSTIC

<b>D5000</b>	X-Lite.....	<b>\$11.25</b>
<b>D5100</b>	Lite.....	<b>11.25</b>
<b>D5200</b>	Med.....	<b>11.25</b>
<b>D5400</b>	12 Stg. Xlt.....	<b>18.25</b>
<b>D5500</b>	12 Stg. Lite.....	<b>18.25</b>

### CLASSICAL

<b>D10H</b>	High Tension.....	<b>\$12.00</b>
<b>D30HB</b>	Ball End.....	<b>13.00</b>

[www.martinguitar.com](http://www.martinguitar.com)

## VEGA STRINGS

### 5 STRING BANJO – Light Gauge

<b>V700</b>	Complete Set.....	<b>\$8.75</b>
<b>V10</b>	.010.....	<b>19.10 dz.</b>

### 5 STRING BANJO – Medium Gauge

<b>V730</b>	Complete Set.....	<b>\$8.75</b>
-------------	-------------------	---------------

### TENOR BANJO

<b>V720</b>	Complete Set.....	<b>\$8.25</b>
-------------	-------------------	---------------

## FAMOUS 351 STRINGS

<b>SE3519</b>	Electric, .009-.042.....	<b>\$ 3.80</b>
<b>SE35110</b>	Electric, .010-.046.....	<b>3.80</b>
<b>SA35112</b>	Acoustic, .012-.053.....	<b>3.80</b>
<b>SC3515P</b>	Classical, Clear/Silver.....	<b>3.80</b>
<b>SB35145</b>	Bass, .045-.105.....	<b>14.20</b>

FAX & E-MAIL ORDERS FOR  
PRINTED MUSIC WILL GET AN EXTRA  
**5% DISCOUNT**

FAX:  
(708) 496-2130  
(888) 983-5537

E-MAIL:  
[sales@harristeller.com](mailto:sales@harristeller.com)

## SNARLING DOG STRINGS

### NICKEL

<b>SDN09</b>	XL Electric, 9-42.....	<b>\$8.15</b>
<b>SDN10</b>	Light Electric, 10-46.....	<b>8.15</b>
<b>SDN11</b>	Medium Electric, 11-49.....	<b>8.15</b>

### PHOSPHOR BRONZE WOUND

<b>SDP10</b>	XLT Acoustic, 10-47.....	<b>\$9.35</b>
<b>SDP12</b>	MLT Acoustic, 12-54.....	<b>9.35</b>
<b>SDP13</b>	Med Acoustic, 13-56.....	<b>9.35</b>

### NICKEL ROUND WOUND

<b>SDN40</b>	Lt Bass, 40-90.....	<b>\$26.85</b>
<b>SDN45</b>	Reg Bass, 45-105.....	<b>26.85</b>
<b>SDN50</b>	Hvy Bass, 50-110.....	<b>26.85</b>
<b>SDN455</b>	5 Stg Bass .045-.130.....	<b>40.00</b>

[www.dandreapicks.com](http://www.dandreapicks.com)

## ELECTRO HARMONIX STRINGS

### ELECTRIC, NICKEL

<b>EHN9</b>	Light.....	<b>\$6.90</b>
<b>EHN10</b>	Regular.....	<b>6.90</b>
<b>EHN11</b>	Medium.....	<b>6.90</b>

# ERNIE BALL SINGLE STRINGS

## ERNIE BALL Custom Gauge Gauged Ball End

**SINGLE STRING SYSTEM**  
Combination assortment of plain & nickel wound electric/acoustic strings from gauges .008 to .060.  
— EB1910 Retail Value.....\$426.25



### DISPLAY RACKS

— EB4918 String Rack, GTR.....\$26.00B  
— EB4919 String Rack, Bass.....28.00B

## Everlast Phosphor Bronze

ES10220	.020	\$3.47
ES10222	.022	
ES10224	.024	
ES10226	.026	
ES10228	.028	
ES10230	.030	4.41
ES10232	.032	
ES10234	.034	
ES10236	.036	
ES10238	.038	
ES10240	.040	7.03
ES10242	.042	
ES10244	.044	
ES10246	.046	
ES10248	.048	
ES10250	.050	9.46
ES10252	.052	
ES10254	.054	
ES10256	.056	

## Everlast 80/20 Bronze

ES10320	.020	\$3.47
ES10322	.022	
ES10324	.024	
ES10326	.026	
ES10328	.028	
ES10330	.030	4.41
ES10332	.032	
ES10334	.034	
ES10336	.036	
ES10338	.038	
ES10340	.040	7.03
ES10342	.042	
ES10344	.044	
ES10346	.046	
ES10348	.048	
ES10350	.050	9.46
ES10352	.052	
ES10354	.054	
ES10356	.056	

## Cobalt Guitar Singles

CS10422	.022	\$3.15
CS10424	.024	
CS10426	.026	
CS10428	.028	
CS10430	.030	3.95
CS10432	.032	
CS10434	.034	
CS10436	.036	
CS10438	.038	
CS10440	.040	5.15
CS10442	.042	
CS10444	.044	
CS10446	.046	
CS10448	.048	
CS10450	.050	6.25
CS10452	.052	
CS10454	.054	
CS10456	.056	
CS10458	.058	

### 3 per pack

CS10460	.060	7.55
CS10462	.062	
CS10464	.064	
CS10466	.066	7.95
CS10468	.068	7.95

## Cobalt Bass Singles (Round Wound)

CS10613	.130	\$23.00
CS10614	.135	24.00
CS10625	.125	22.00
CS10632	.032	14.25
CS10640	.040	14.50
CS10645	.045	14.75
CS10650	.050	15.00
CS10655	.055	15.25
CS10660	.060	15.50
CS10665	.065	15.75
CS10670	.070	16.00
CS10675	.075	16.25
CS10680	.080	16.50
CS10685	.085	17.00
CS10690	.090	17.75
CS10695	.095	18.25
CS10697	.100	19.50
CS10698	.105	20.00
CS10699	.110	21.00



**WE STOCK PRINT MUSIC, INSTRUCTIONAL DVD'S, AND SING-A-LONG CD'S**



Ball, Ernie/How To Play Guitar  
Phase 1.....\$8.95  
Ball, Ernie/How To Play Guitar  
Phase 2.....8.95

## Plain Ball End ELECTRIC OR ACOUSTIC

EB1008	.008	\$1.10
EB1009	.009	
EB1010	.010	
EB1011	.011	
EB1012	.012	
EB1013	.013	
EB1014	.014	
EB1015	.015	
EB1016	.016	
EB1017	.017	
EB1018	.018	
EB1020	.020	
EB1022	.022	
EB1024	.024	

## Nickel Wound ELECTRIC OR ACOUSTIC

EB1118	.018	\$1.80
EB1120	.020	
EB1122	.022	
EB1124	.024	
EB1126	.026	
EB1128	.028	
EB1130	.030	1.90
EB1132	.032	
EB1134	.034	
EB1136	.036	
EB1138	.038	
EB1140	.040	2.05
EB1142	.042	
EB1144	.044	
EB1146	.046	
EB1148	.048	
EB1150	.050	2.25
EB1152	.052	
EB1154	.054	
EB1156	.056	
EB1158	.058	

### 3 per pack

EB1160	.060	3.00
EB1162	.062	
EB1164	.064	
EB1166	.066	
EB1168	.068	
EB1170	.070	
EB1174	.074	

## Loop End BANJO, MANDOLIN

EB1309	.009	\$1.10
EB1310	.010	
EB1311	.011	
EB1312	.012	
EB1313	.013	
EB1314	.014	
EB1315	.015	
EB1316	.016	
EB1317	.017	
EB1320	.020	2.05
EB1322	.022	
EB1324	.024	
EB1326	.026	
EB1328	.028	
EB1330	.030	2.15
EB1332	.032	
EB1334	.034	
EB1336	.036	

## RPS Singles

EB1028	.008	\$1.35
EB1029	.009	
EB1030	.010	
EB1031	.011	
EB1032	.012	
EB1033	.013	1.35
EB1034	.014	
EB1036	.016	
EB1037	.017	

## Bass (Round Wound)

EB1632	.032	\$6.25
EB1640	.040	7.95
EB1645	.045	
EB1650	.050	
EB1655	.555	
EB1660	.060	8.75
EB1665	.065	
EB1670	.070	9.25
EB1675	.075	
EB1680	.080	
EB1685	.085	
EB1690	.090	
EB1695	.095	10.20
EB1697	.100	
EB1698	.105	
EB1699	.110	
EB1625	.125	11.35
EB1613	.130	13.00

## Nylon Classic ERNESTO PALLA

EB1501	Clear	1st	\$ .95
EB1502		2nd	1.05
EB1503		3rd	1.15
EB1511	Black	1st	.95
EB1512		2nd	1.05
EB1513		3rd	1.15
EB1521	Ball	1st	1.05
EB1522	End	2nd	1.15
EB1523		3rd	1.30
EB1524		4th	2.25
EB1525		5th	2.60
EB1526		6th	2.85
EB1534	Silvr	4th	2.25
EB1535		5th	2.60
EB1536		6th	2.85
EB1544	Gold	4th	2.25
EB1545		5th	2.60
EB1546		6th	2.85

## EARTHWOOD 80/20 Bronze

EB1420	.020	\$1.80
EB1422	.022	
EB1424	.024	
EB1426	.026	
EB1428	.028	
EB1430	.030	1.90
EB1432	.032	
EB1434	.034	
EB1436	.036	
EB1438	.038	
EB1440	.040	2.05
EB1442	.042	
EB1444	.044	
EB1446	.046	
EB1448	.048	
EB1450	.050	2.25
EB1452	.052	
EB1454	.054	
EB1456	.056	

## Bass (Flat Wound)

EB1740	.040	\$13.90
EB1745	.045	
EB1750	.050	
EB1760	.060	15.75
EB1765	.065	
EB1770	.070	15.75
EB1780	.080	
EB1785	.085	
EB1790	.090	
EB1795	.095	
EB1797	.100	16.50
EB1798	.105	
EB1799	.110	18.50

# ERNIE BALL STRING SETS

## ERNIE BALL NICKEL

EB2204	Medium	\$9.80
EB2206	Medium-Light	9.80
EB2208	Light	9.80
EB2210	Extra-Light	9.80
EB2215	Skinny Top He'vy Btm	9.00
EB2233	12-Str. Light	14.50
EB2236	12-Str. Medium	15.75
EB2501	10-Str. C6 Steel Guitar	16.00
EB2502	10-Str. E9 Steel Guitar	14.50
EB2837	6 Str. Bass Guitar (.020-.090)	17.00
EB2839	6 Str. Baritone	11.35

## SLINKY

EB2221	Reglr Slinky (Lime) 10-46	\$8.50
EB2222	Hybrid Slinky (Orange) 9-46	8.50
EB2223	Super Slinky (Pink) 9-42	8.50
EB2225	Extra Slinky (Blue) 8-38	8.50
EB2220	Power Slinky (Purple) 11-48	8.50
EB2626	Not Even Slinky (12-56)	9.25
EB2627	Beefy Slinky (11-54)	9.25
EB2625	8-Str. Slinky (.10-.074)	16.00
EB2230	12-Str. Slinky (Green)	14.00

## CLASSIC SLINKY

### PURE NICKEL WINDINGS

EB2250	Power Slinky	\$10.00
EB2251	Regular Slinky	10.00
EB2252	Hybrid Slinky	10.00
EB2253	Super Slinky	10.00
EB2255	Extra Slinky	10.00

## RPS SLINKY

EB2238	RPS 8 Extra Slinky	\$9.80
EB2239	RPS 9 Super Slinky	9.80
EB2240	RPS 10 Reg. Slinky	9.80
EB2241	RPS Hybrid Slinky	9.80
EB2242	RPS Power Slinky	9.80

## STAINLESS STEEL SLINKY

EB2246	Reglr. Slinky	\$8.75
EB2247	Hybrid Slinky	8.75
EB2248	Super Slinky	8.75
EB2249	Extra Slinky	8.75
EB2245	Power Slinky	8.75

## COATED SLINKY

### TITANIUM REINFORCED

EB3115	Skinny Top, Heavy Bottom	\$18.25
EB3120	Power	17.00
EB3121	Regular	17.00
EB3122	Hybrid	17.00
EB3123	Super	17.00
EB3125	Extra	17.00
EB3126	Not Even	18.25
EB3127	Beefy	18.25

## BANJO, MANDO, NYLON

EB2303	Tenor Banjo Med.	\$6.50
EB2306	Tenor Banjo Light	6.50
EB2309	5-Str. Banjo Med.	6.25
EB2312	5-Str. Banjo Light	6.25
EB2320	Mandolin Medium	10.50
EB2323	Mandolin Light	10.50
EB2403	Nylon Clear & Silver	9.25
EB2406	Nylon Black & Silver	9.25
EB2409	Nylon Ball End	9.50

## EARTHWOOD

### 80/20 BRONZE WOUND

EB2002	Medium (13-56)	\$9.25
EB2003	Medium-Light (12-54)	9.25
EB2004	Light (11-52)	9.25
EB2006	Extra-Light (10-50)	9.25
EB2008	Rock & Blues (10-52)	9.00
EB2010	12-String Light (9-46)	14.50
EB2012	12-String Medium (11-52)	15.75
EB2043	Silk & Steel Regular	15.00
EB2045	Silk & Steel Soft	15.00
EB2047	Silk & Steel Ex-Soft	15.00
EB2051	Silk & Steel 12-Str. Sft	19.50
EB2069	Folk Nylon Ball End	10.00
EB2061	5-Str. Banjo Frailing	6.25
EB2063	5-Str. Banjo Bluegrass	6.25
EB2065	Folk Mandolin Medium	10.50
EB2067	Folk Mandolin Light	10.50
EB2070	Acoustic Bass (45-95)	40.00

### SLINKY ACOUSTIC PHOSPHOR BRONZE WOUND

EB2144	Power	\$10.50
EB2146	Regular	10.50
EB2148	Super	10.50
EB2150	Extra	10.50
EB2151	Hybrid	10.50
EB2153	12 String Slinky	15.75

## ALUMINUM BRONZE ACOUSTIC

2564	Medium (13-56)	\$13.50
2566	Medium Light (12-54)	13.50
2568	Light (11-52)	13.50
2570	Extra Light (10-50)	13.50

## SLINKY SEVEN STRING

EB2620	Power Slinky	\$10.80
EB2621	Regular Slinky	10.80
EB2623	Super Slinky	10.80

## RW SLINKY BASS

EB2831	Power (55-110)	\$36.00
EB2832	Regular (50-105)	36.00
EB2833	Hybrid (45-105)	36.00
EB2834	Super (45-100)	36.00
EB2835	Extra (40-95)	36.00
EB2849	Hybrid, Super Long (.45-.105)	38.00
EB2838	6 String (32-130)	51.00

## RW SLINKY 5 BASS

EB2821	Power (50-135)	\$45.25
EB2824	Super (40-125)	45.25
EB2836	Regular (45-130)	45.25
EB2850	Regular (45-130), Super Long	47.00

## COATED SLINKY BASS

EB3832	Regular (50-105)	\$60.00
EB3833	Hybrid (45-105)	60.00
EB3834	Super (45-100)	60.00
EB3836	5 String Regular (45-130)	70.00

## EVERLAST COATED

### PHOSPHOR BRONZE ACOUSTIC

EB2544	Medium	\$27.99
EB2546	Medium Light	27.99
EB2548	Light	27.99
EB2550	Extra Light	27.99

## EVERLAST COATED

### 80/20 BRONZE WOUND

EB2554	Acoustic Medium	\$27.99
EB2556	Acoustic Medium Light	27.99
EB2558	Acoustic Light	27.99
EB2560	Acoustic Extra Light	27.99

## COBALT ELECTRIC SLINKY COATED

EB2715	Skinny Top/ Heavy Bottom Slinky (10-52)	\$18.25
EB2720	Power Slinky (11-48)	17.00
EB2721	Regular Slinky (10-46)	17.00
EB2722	Hybrid Slinky (9-46)	17.00
EB2723	Super Slinky (9-42)	17.00
EB2725	Extra Slinky (8-38)	17.00
EB2726	Not Even Slinky (12-56)	18.25
EB2727	Beefy Slinky (11-54)	18.25
EB2728	Regular 7-string (10-56)	21.00
EB2729	Power 7-string (11-58)	21.00
EB2730	Skinny Top/Heavy Bottom 7-string (10-62)	22.75

## COBALT SLINKY BASS COATED

EB2731	Power (55-110)	\$59.99
EB2732	Regular (50-105)	59.99
EB2733	Hybrid (45-105)	59.99
EB2734	Super (45-100)	59.99
EB2735	Extra (40-95)	59.99
EB2736	5 String (45-130)	69.99

## M-STEEL

EB2915	M-Steel Skinny Top/ Heavy Bottom (10-52)	\$22.75
EB2920	M-Steel Power (11-46)	21.50
EB2921	M-Steel Regular (10-46)	21.50
EB2922	M-Steel Hybrid (9-46)	21.50
EB2923	M-Steel Super (9-42)	21.50



## FLATWOUND BASS

EB2802	Group I Firm (55-110)	\$60.00
EB2804	Group II Semi-Firm (50-105)	60.00
EB2806	Group III Semi-Flex (45-100)	60.00
EB2808	Group IV Flex (40-95)	60.00

PRICES SUBJECT TO CHANGE WITHOUT NOTICE

# DEAN MARKLEY STRINGS



## Vintage Bronze Acoustic

<b>DMS2002</b>	(85/15) LT	11-46 .....	<b>\$11.00</b>
<b>DMS2004</b>	(85/15) MED LT	12-54 .....	<b>11.00</b>
<b>DMS2006</b>	(85/15) MED	13-58 .....	<b>11.00</b>
<b>DMS2008</b>	(85/15) X-LT	10-48 .....	<b>11.00</b>

## Vintage Bronze Acoustic 12-String

<b>DMS2202</b>	(85/15) LT	9-24 .....	<b>\$13.99</b>
<b>DMS2204</b>	(85/15) Med LT	11-30 .....	<b>13.99</b>
<b>DMS2206</b>	(85/15) MED	12-30 .....	<b>13.99</b>

## Blue Steel Acoustic

<b>DMS2032</b>	XL	10-48 .....	<b>\$13.99</b>
<b>DMS2034</b>	LT	11-46 .....	<b>13.99</b>
<b>DMS2033</b>	TLT	11-52 .....	<b>13.99</b>
<b>DMS2036</b>	ML	12-54 .....	<b>13.99</b>
<b>DMS2038</b>	MED	13-58 .....	<b>13.99</b>

## Helix HD Acoustic

<b>DMS2080</b>	80/20	.010-.047 .....	<b>\$13.99</b>
<b>DMS2081</b>	80/20	.011-.052 .....	<b>13.99</b>
<b>DMS2082</b>	80/20	.012-.053 .....	<b>13.99</b>
<b>DMS2083</b>	80/20	.013-.056 .....	<b>13.99</b>

## Helix HD Acoustic Phosphor Bronze

<b>DMS2085</b>	Phos. XL	.010-.047 .....	<b>\$14.95</b>
<b>DMS2086</b>	Phos. LT	.011-.052 .....	<b>14.95</b>
<b>DMS2087</b>	Phos. CL	.012-.053 .....	<b>14.95</b>
<b>DMS2088</b>	Phos. MED	.013-.056 .....	<b>14.95</b>

## Bajo Sexto Sets

<b>DMS2095</b>	Diez Cuerda	28-74 .....	<b>\$23.99</b>
<b>DMS2096</b>	Doce Cuerdas	28-92 .....	<b>29.99</b>

## Banjo: 5 String

<b>DMS2302</b>	LT	009-020W .....	<b>\$6.99</b>
<b>DMS2304</b>	MED LT	010-024W .....	<b>6.99</b>
<b>DMS2306</b>	MED	011-026W .....	<b>6.99</b>

## Mandolin: Phosphor Bronze

<b>DMS2402</b>	LT	011-037W .....	<b>\$8.99</b>
<b>DMS2404</b>	REG	011-039W .....	<b>8.99</b>

## SR2000™ Bass, 4, 5, 6 & 7 String

<b>DMS2688</b>	4-String LT	44-98 .....	<b>\$49.99</b>
<b>DMS2689</b>	4-String ML	46-102 .....	<b>49.99</b>
<b>DMS2690</b>	4-String MC	47-107 .....	<b>49.99</b>
<b>DMS2691</b>	4-String MED	48-106 .....	<b>49.99</b>
<b>DMS2692</b>	5-String LT	44-125 .....	<b>59.99</b>
<b>DMS2693</b>	5-String ML	46-125 .....	<b>59.99</b>
<b>DMS2694</b>	5-String MC	47-127 .....	<b>59.99</b>
<b>DMS2698</b>	6-String MC	27-127 .....	<b>71.99</b>
<b>DMS2698C</b>	7-String MC	22-127 .....	<b>77.00</b>

## Super Round™ Bass 4-5 String

<b>DMS2632</b>	4-String LT	40-100 .....	<b>\$34.00</b>
<b>DMS2634</b>	4-String ML	45-105 .....	<b>34.00</b>
<b>DMS2636</b>	4-String MED	50-110 .....	<b>34.00</b>
<b>DMS2638</b>	5-String LT	45-125 .....	<b>44.99</b>
<b>DMS2639</b>	5-String ML	45-128 .....	<b>44.99</b>
<b>DMS2640</b>	5-String MED	50-128 .....	<b>44.99</b>

## Nickelsteel™ Bass 4-5 String

<b>DMS2608A</b>	4-String XL	40-95 .....	<b>\$30.99</b>
<b>DMS2602A</b>	4-String LT	40-100 .....	<b>30.99</b>
<b>DMS2604A</b>	4-String ML	45-105 .....	<b>30.99</b>
<b>DMS2606A</b>	4-String MED	48-106 .....	<b>30.99</b>
<b>DMS2608B</b>	5-String XL	40-55-75-95-128 .....	<b>37.99</b>
<b>DMS2602B</b>	5-String LT	40-60-80-100-128 .....	<b>37.99</b>
<b>DMS2604B</b>	5-String ML	45-128 .....	<b>37.99</b>
<b>DMS2606B</b>	5-String MED	48-128 .....	<b>37.99</b>

## Helix Pure Nickel Electric

<b>DMS2511PN</b>	Helix Pure Nickel Light, 9-42 .....	<b>\$17.99</b>
<b>DMS2512PN</b>	Helix Pure Nickel Custom Light, 9-46 .....	<b>17.99</b>
<b>DMS2513PN</b>	Helix Pure Nickel Regular, 10-46 .....	<b>17.99</b>
<b>DMS2514PN</b>	Helix Pure Nickel Light Jazz/Blues, 11-49 .....	<b>17.99</b>
<b>DMS2515PN</b>	Helix Pure Nickel Light Top Heavy Bottom, 10-52 .....	<b>17.99</b>
<b>DMS2516PN</b>	Helix Pure Nickel Medium Jazz, 12-52 .....	<b>17.99</b>

## Ball End Nylon

<b>DMS2802</b>	Silver & Clear	28-42 .....	<b>\$17.99</b>
----------------	----------------	-------------	----------------

## Master Series Nylon

<b>DMS2830</b>	Normal Tension	28-42 .....	<b>\$14.99</b>
<b>DMS2832</b>	Hard Tension	28-44 .....	<b>14.99</b>
<b>DMS2834</b>	X-Hard Tension	28-45 .....	<b>14.99</b>

# DEAN MARKLEY STRINGS

## Signature Nickelsteel Electric™

DMS2501	XL	8-38.....	\$9.99
DMS2502	LT	9-42.....	9.99
DMS2508	CL	9-46.....	9.99
DMS2503	REG	10-46.....	9.99
DMS2504	LTHB	10-52.....	9.99
DMS2505	MED (20W/18P)	11-52.....	9.99
DMS2506	JZ	12-54.....	9.99
DMS2500	DT (D-Tune)	13-56.....	9.99

## Blue Steel™ Electric

DMS2550	XL	8-38.....	\$11.99
DMS2552	LT	9-42.....	11.99
DMS2554	CL	9-46.....	11.99
DMS2556	REG	10-46.....	11.99
DMS2562	MED (20W/18P)	11-52.....	11.99
DMS2558	LTHB	10-52.....	11.99
DMS2555	JZ	12-54.....	11.99
DMS2557	DT	13-56.....	11.99

## Helix HD™ Electric

DMS2511	LT	9-42.....	\$13.99
DMS2512	CL	9-46.....	13.99
DMS2513	REG	10-46.....	13.99
DMS2514	STAR	10-49.....	13.99
DMS2515	LTHB	10-52.....	13.99
DMS2516	MED	11-52.....	13.99
DMS2517	Carl Verheyen Signature Model	9-46.....	13.99
DMS2518	Nick Catanese Signature Model	10-56.....	13.99

## Blue Steel™ Bass 4-5 String

DMS2670	4-String XL	40-95.....	\$37.99
DMS2672	4-String LT	45-100.....	37.99
DMS2673	4-String CL	46-102.....	37.99
DMS2674	4-String ML	45-105.....	37.99
DMS2675	4-String XM	50-110.....	37.99
DMS2676	4-String MED	50-105.....	37.99
DMS2678	5-String LT	45-125.....	37.99
DMS2679	5-String ML	45-128.....	37.99
DMS2680	5-String MED	50-128.....	37.99

## Helix HD™ SS Bass 4-5 String

DMS2613	4-String LT	45-100.....	\$49.99
DMS2614	4-String ML	45-105.....	49.99
DMS2615	4-String MED	50-105.....	49.99
DMS2613B	5-String LT	45-60-80-100-128.....	59.99
DMS2614B	5-String ML	45-65-80-105-128.....	59.99
DMS2615B	5-String MED	50-128.....	59.99
DMS2620	4-String Nikki Six Signature Model	50-110.....	49.99

# DEAN MARKLEY SINGLES

### PLAIN/DOZ.

DMS008.....	\$14.40
DMS009.....	14.40
DMS010.....	14.40
DMS011.....	14.40
DMS012.....	14.40
DMS013.....	14.40
DMS014.....	14.40
DMS015.....	14.40
DMS016.....	14.40
DMS017.....	14.40
DMS018P.....	16.20

### WOUND/DOZ.

DMS024W.....	\$25.20
DMS032.....	28.20
DMS036.....	28.20
DMS042.....	28.20



www.deanmarkley.com

# ADAMAS STRINGS

### Environmental Phosphor Bronze

K1717E	Adamas XL.....	\$14.09
K1818E	Adamas L.....	14.09
K1919E	Adamas M.....	14.09

### Phosphor Bronze

K1717	Adamas XL.....	\$13.99
K1818	Adamas L.....	14.49
K1919	Adamas M.....	14.49
K1616	Adamas 12 String L.....	21.99

### Classic

K4646	Century Normal tens, Ball end.....	\$14.99
-------	---------------------------------------	---------

### Electric Bass

KEXN45	Adamas EX M.....	\$32.99
--------	------------------	---------

### Mandolin

K8080	Adamas Ball End.....	\$14.90
-------	----------------------	---------

### Fiddle

K8989	Adamas.....	\$10.49
-------	-------------	---------

### ELECTRIC SETS – POWER WOUND – NICKEL

SITS838	Ultra Light.....	\$8.99
SITS942	Extra Light.....	8.99
SITS946	Rock 'n Roll.....	8.99
SITS1038	Lt. Bottom.....	8.99
SITS1046	Light.....	8.99
SITS1052	Heavy Bottom.....	9.49
SITS1150	Med. Light.....	9.99

### SUPER HOOKS ELECTRIC SETS – POWER WOUND – NICKEL

(For Floyd Rose type tremolos – no ball end)

SITS942FR	Extra Light.....	\$9.49
-----------	------------------	--------

### ELECTRIC BASS SETS ROUND/WOUND LONG

NR45100L	Power Wound Nickel Lt. ....	\$35.49
NR50105L	Power Wound Nickel Md. ....	35.49
SSR45100L	Stainless Steel Lt. ....	35.40

### ACOUSTIC SETS PHOSPHOR BRONZE

SITP1048	Ex. Light.....	\$10.99
SITP1150	Pro Light.....	10.99
SITP1254	Light.....	10.99
SITP1356	Medium.....	10.99
SITP121046	12-String.....	15.99

### ELECTRIC SETS – PURE NICKEL

SITPN942	Extra Light.....	\$10.49
SITPN946	Rock 'n Roll.....	10.49
SITPN1046	Light.....	10.49

### BUDDY EMMONS PEDAL STEEL SETS – NICKEL

SITBEE9	10-String.....	\$13.49
SITBEC6	10-String (1st D).....	17.99

### PEDAL STEEL SETS – POWER WOUND – NICKEL

SITEME9	10-String.....	\$15.99
SITEMC6	10-String.....	20.49
SITSHOE9	10-String.....	13.99

### PEDAL STEEL SETS – STAINLESS STEEL

SITSSEME9	10-String.....	\$13.49
-----------	----------------	---------

### CLASSITS – CLEAR TREBLES/SILVER BASSES

SITSCM101	Medium Tension.....	\$ 9.99
SITSCH102	Hard Tension.....	9.99

### ACOUSTICS SETS – DARK ROYAL™ BRONZE

SITRL1254	Light.....	\$14.49
SITRL1356	Medium.....	14.99

www.sitstrings.com

# WE STOCK GUITAR AND BASS METHOD BOOKS

# MARTIN STRINGS

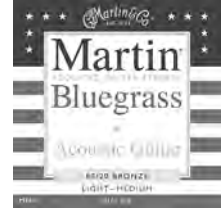

### Martin SP Lifespan 80/20 Bronze

MSP6000	Extra Light	10	14	23	30	39	47	.....	\$29.99
MSP6050	Custom Light	11	15	23	32	42	52	.....	\$29.99
MSP6100	Light	12	16	25	32	42	54	.....	\$29.99
MSP6200	Medium	13	17	26	35	45	56	.....	\$29.99

### Martin SP Lifespan 92/8 Phosphor Bronze

MSP7000	Extra Light	10	14	23	30	39	47	.....	\$31.99
MSP7050	Custom Light	11	15	23	32	42	52	.....	\$31.99
MSP7100	Light	12	16	25	32	42	54	.....	\$31.99
MSP7200	Medium	13	17	26	35	45	56	.....	\$31.99

### Martin SP Lifespan 12 String 92/8 Phosphor Bronze

MSP7600	Extra Light	10	14	23	30	39	47	.....	\$45.99
		10	14	10	12	18	27		
MSP7700	Baritone	14	20	30	42	54	70	.....	\$39.99



### Martin SP - Studio Performance 80/20 Bronze

MSP3000	Extra Light	10	14	23	30	39	47	.....	\$15.75
MSP3050	Custom Light	11	15	23	32	42	52	.....	\$15.75
MSP3100	Light	12	16	25	32	42	54	.....	\$15.75
MSP3150	Light/Medium	12.5	16.5	25.5	33.5	43.5	55	.....	\$15.75
MSP3200	Medium	13	17	35	35	45	56	.....	\$15.75
MSP3250	Bluegrass	13	17	36	36	46	56	.....	\$15.75

### Martin SP - Studio Performance 12 String 80/20 Bronze

MSP3600	Extra Light	10	14	23	30	39	47	.....	\$22.99
		10	14	10	12	18	27		



### Martin SP - Studio Performance 92/8 Phosphor Bronze

MSP4000	Extra Light	10	14	23	30	39	47	.....	\$17.25
MSP4050	Custom Light	11	15	23	32	42	52	.....	\$17.25
MSP4100	Light	12	16	25	32	42	54	.....	\$17.25
MSP4150	Light/Medium	12.5	16.5	25.5	33.5	43.5	55	.....	\$17.25
MSP4200	Medium	13	17	26	35	45	56	.....	\$17.25
MSP4250	Bluegrass	13	17	26	36	46	56	.....	\$17.25
MSPHT10	High Tuning	10	12	8	13	17	25	.....	\$14.50

### Martin SP - Studio Performance 12 String 92/8 Phosphor Bronze

MSP4600	Extra Light	10	14	23	30	39	47	.....	\$24.99
		10	14	10	12	18	27		

### Martin SP - Acoustic Bass 4 String 92/8 Phosphor Bronze

MSP4800	Light	45	65	80	100	.....	\$44.99
MSP4850	Medium	45	65	85	105	.....	\$44.99

### Martin Light Gauge, 80/20 Bronze Wound

M12	E-1st Silvered Steel	.....	.012-0.305						\$19.10 doz.
M16	B-2nd Silvered Steel	.....	.016-0.406						\$19.10 doz.
M25B	G-3rd Bronze Wound	.....	.025-0.635						\$4.70 doz.
M32B	D-4th Bronze Wound	.....	.032-0.813						\$4.70 doz.
M42B	A-5th Bronze Wound	.....	.042-1.067						\$4.70 doz.
M54B	E-6th Bronze Wound	.....	.054-1.321						\$4.70 doz.
M140	.....Light								\$11.65

### Martin Medium Gauge, 80/20 Bronze Wound

M13	E-1st Silvered Steel	.....	.013-0.330						\$19.10 doz.
M17	B-2nd Silvered Steel	.....	.017-0.432						\$19.10 doz.
M26B	G-3rd Bronze Wound	.....	.026-0.660						\$4.70 doz.
M35B	D-4th Bronze Wound	.....	.035-0.889						\$4.70 doz.
M45B	A-5th Bronze Wound	.....	.045-1.143						\$4.70 doz.
M56B	E-6th Bronze Wound	.....	.056-1.422						\$4.70 doz.
M150	.....Medium								\$11.65

### Martin 80/20 Bronze

M170	Extra Light	10	14	23	30	39	47	.....	\$11.65
M175	Custom Light	11	15	23	32	42	52	.....	\$11.65
M145	Light/Medium	12.5	16.5	25.5	33.5	43.5	55	.....	\$11.65
M240	Bluegrass	12	16	25	35	45	56	.....	\$11.65

### Retro & Artist Choice

#### Tony Rice Signature Set - Martin Monels

MTR13	Bluegrass	.013	.016	.026	.034	.044	.056	.....	\$21.49
MM11	Light	.012	.015	.025	.031	.041	.054	.....	\$21.49
MM12	Custom Light	.012	.014	.023	.031	.041	.052	.....	\$21.49

### Martin 12 String 80/20 Bronze

M180	Extra Light	10	14	23	30	39	47	.....	\$18.49
		10	14	10	12	18	27		
M190	Light	12	16	25	32	42	54	.....	\$18.49
		12	16	10	14	20	30		

### Martin Marquis 80/20 Bronze

M1000	Extra Light	10	14	23	30	39	47	.....	\$13.75
M1100	Light	12	16	25	32	42	54	.....	\$13.75
M1200	Medium	13	17	26	35	45	56	.....	\$13.75

### Martin Marquis 12 String 80/20 Bronze

M1600	Extra Light	10	14	23	30	39	47	.....	\$21.99
		10	14	10	12	18	27		
M1700	Light	12	16	25	32	42	54	.....	\$21.99
		12	16	10	14	20	30		

### Martin Silk & Steel Folk

M1400	Marquis	11.5	14	23	28	38	47	.....	\$17.49
M130	Standard	11.5	14	23	28	38	47	.....	\$16.25
M200	12 String	11.5	14	23	28	38	47	.....	\$21.99
		11.5	14	10	14	18			

### Martin 92/8 Phosphor Bronze

M530	Extra Light	10	14	23	30	39	47	.....	\$12.99
M535	Custom Light	11	15	23	32	42	52	.....	\$12.99
M540	Light	12	16	25	32	42	54	.....	\$12.99
M545	Light/Medium	12.5	16.5	25.5	33.5	43.5	55	.....	\$12.99
M550	Medium	13	17	26	35	45	56	.....	\$12.99

### Martin 12 String 92/8 Phosphor Bronze

M500	Extra Light	10	14	23	30	39	47	.....	\$20.49
		10	14	10	12	18	27		

### Martin Marquis 92/8 Phosphor Bronze

M2000	Extra Light	10	14	23	30	39	47	.....	\$14.99
M2100	Light	12	16	25	32	42	54	.....	
M2200	Medium	13	17	26	35	45	56	.....	

### Martin Marquis 12 String 92/8 Phosphor Bronze

M2600	Extra Light	10	14	23	30	39	47	.....	\$23.49
		10	14	10	12	18	27		



# MARTIN STRINGS



**Martin FX – Flexible Core 92/8 Phosphor Bronze**

<b>MFX775</b>	Custom Light	11	15	23	32	42	52	.....	<b>\$14.99</b>
<b>MFX740</b>	Light	12	16	25	32	42	54	.....	<b>\$14.99</b>
<b>MFX745</b>	Light/Medium	12.5	16.5	22.5	33.5	43.5	55	.....	<b>\$14.99</b>
<b>MFX750</b>	Medium	13	17	26	35	45	56	.....	<b>\$14.99</b>

**Martin FX – Flexible Core 12 String**

<b>MFX700</b>	Custom	10	14	25	32	42	54	.....	<b>\$23.49</b>
		10	14	10	12	18	27		

**Martin FX – Flexible Core Silk & Phosphor**

<b>MFX130</b>	Custom	11	13	23	28	38	47	.....	<b>\$14.99</b>
---------------	--------	----	----	----	----	----	----	-------	----------------

**Martin FX – Flexible Core 80/20 Bronze**

<b>MFX675</b>	Custom Light	11	15	23	32	42	52	.....	<b>\$13.75</b>
<b>MFX640</b>	Light	12	16	25	32	42	54	.....	<b>\$13.75</b>
<b>MFX645</b>	Light/Medium	12.5	16.5	25.5	33.5	43.5	55	.....	<b>\$13.75</b>
<b>MFX650</b>	Medium	13	17	26	35	45	56	.....	<b>\$13.75</b>



**Clapton's Choice – Phosphor Bronze**

<b>MEC12</b>	Light	12	16	25	32	42	54	.....	<b>\$14.99</b>
<b>MEC13</b>	Medium	13	17	26	35	45	56	.....	<b>\$14.99</b>

**Martin Classics – Crystal Nylon**

<b>M120</b>	Silver/Plain	28	32	40	30	35	43	.....	<b>\$12.49</b>
<b>M160</b>	Silver/Ball	28	32	40	30	35	43	.....	<b>\$13.49</b>
<b>M220</b>	Bronze/Plain	28	32	40	30	35	43	.....	<b>\$12.49</b>
<b>M260</b>	Bronze/Ball	28	32	40	30	35	43	.....	<b>\$13.49</b>

**Vega Banjo – Silvered Steel/Nickel Wound**

<b>V700</b>	Light	9	10	13	20	9	.....	<b>\$8.75</b>
<b>V730</b>	Medium	10	12	16	23	10	.....	<b>\$8.75</b>
<b>V720</b>	Tenor 4 string	9	16	23	30	.....	<b>\$8.25</b>	

**Martin Resonator Guitar – Silvered Steel/Nickel Wound**

<b>M980</b>	Light	16	18	26	36	46	56	.....	<b>\$10.99</b>
-------------	-------	----	----	----	----	----	----	-------	----------------

**Martin Dulcimer – Silvered Steel/Nickel Wound**

<b>M640</b>	Standard	12	12	12	22	.....	<b>\$6.25</b>
-------------	----------	----	----	----	----	-------	---------------

**Martin Mandolin 80/20 Bronze**

<b>M400</b>	Standard	10	10	14	14	24	24	34	34	.....	<b>\$11.99</b>
<b>M450</b>	Bluegrass	11	11	14	14	24	24	38	38	.....	<b>\$11.99</b>

**Martin Ukulele – Fluorocarbon**

<b>M600</b>	Soprano	19	26	34	22	.....	<b>\$13.99</b>
<b>M630</b>	Baritone	22	26	34	35	.....	<b>\$13.99</b>

# THOMASTIK INFELD STRINGS

**GEORGE BENSON SERIES**

<b>GB114</b>	Nickel Flatwound, 014-055	.....	<b>\$69.99</b>
<b>GB112</b>	Nickel Flatwound, 012-053	.....	<b>\$69.99</b>
<b>GR112</b>	Nickel Roundwound, 012-053	.....	<b>\$69.99</b>



**POWER BRIGHTS - Regular Bottoms**

<b>PB109</b>	Light, 009-042	.....	<b>\$37.99</b>
<b>PB110</b>	Med. Light, 010-045	.....	<b>\$37.99</b>
<b>PB111</b>	Medium, 011-046	.....	<b>\$37.99</b>

**POWER BRIGHTS - Heavy Bottoms**

<b>RP109</b>	Light, 009-046	.....	<b>\$37.99</b>
<b>RP110</b>	Med. Light, 010-050	.....	<b>\$37.99</b>
<b>RP111</b>	Medium, 011-053	.....	<b>\$37.99</b>

**SLIDERS BLUES Series - Silk Inlay**

<b>SL109</b>	Light, 009-043	.....	<b>\$39.99</b>
<b>SL110</b>	Med. Light, 010-048	.....	<b>\$39.99</b>

**POWERBASS SERIES - MAGNACORE, BASS GUITAR**

<b>EB344</b>	Long Scale 34"/4-String, 047-107	.....	<b>\$122.99</b>
<b>EB345</b>	Long Scale 34"/5-String, 047-119	.....	<b>\$170.99</b>
<b>EB346</b>	Long Scale 34"/6-String, 032-119	.....	<b>\$193.99</b>

**JAZZ ELECTRIC BASS Series - RoundwoundNickel**

<b>JR344</b>	Long Scale 34"/4-String, 043-089	.....	<b>\$146.99</b>
<b>JR345</b>	Long Scale 34"/5-String, 043-118	.....	<b>\$193.99</b>



**JAZZ ELECTRIC BASS Series - Flatwound**

<b>JF324</b>	Short Scale 32"/4-String, 043-106	.....	<b>\$146.99</b>
<b>JF344</b>	Long Scale 34"/4-String, 043-100	.....	<b>\$146.99</b>
<b>JF345</b>	Long Scale 34"/5-String, 043-136	.....	<b>\$214.99</b>
<b>JF346</b>	Long Scale 34"/6-String, 033-136	.....	<b>\$237.99</b>
<b>JF364</b>	X-Long Scale 36"/4-String, 044-096	.....	<b>\$146.99</b>

**ACOUSTIC BASS Series - Bronze**

<b>AB344</b>	Long Scale 34"/4-String, 041-086	.....	<b>\$136.99</b>
<b>AB345</b>	Long Scale 34"/5-String, 041-086	.....	<b>\$226.99</b>

**SUPER ALLOY BASS**

<b>IN344</b>	45-105	.....	<b>\$84.99</b>
--------------	--------	-------	----------------

**MANDOLIN**

<b>DRT154</b>	Classic C Series	.....	<b>\$90.99</b>
---------------	------------------	-------	----------------

**VIOLIN**

<b>PI100</b>	Peter Infeld Signature Violin Strings with Platinum E	.....	<b>\$222.50</b>
--------------	---	-------	-----------------

**CLASSIC N Series**

<b>CR127</b>	Normal Tension, Copper Core	.....	<b>\$33.99</b>
<b>CF127</b>	Normal Tension, Chrome Core	.....	<b>\$37.99</b>
<b>KF110</b>	Extra Hard Tension, Steel Core	.....	<b>\$52.99</b>
<b>KR116</b>	Hard Tension, Rope Core	.....	<b>\$65.99</b>

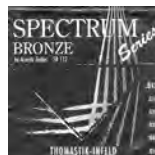

**SPECTRUM BRONZE Series**

<b>SB110</b>	Extra Light, 010-050	.....	<b>\$42.99</b>
<b>SB111</b>	Light, 011-052	.....	<b>\$42.99</b>
<b>SB112</b>	Med. Light, 012-054	.....	<b>\$42.99</b>
<b>SB113</b>	Medium, 013-057	.....	<b>\$42.99</b>
<b>SB210</b>	Extra Light, 010-041, 12 String	.....	<b>\$75.99</b>
<b>SB211</b>	Light, 011-052, 12 String	.....	<b>\$75.99</b>

**PLECTRUM ACOUSTIC Series**

<b>AC110</b>	Extra Light, 010-041	.....	<b>\$42.99</b>
<b>AC111</b>	Light, 011-050	.....	<b>\$42.99</b>
<b>AC210</b>	Extra Light, 010-041, 12 String	.....	<b>\$75.99</b>
<b>AC211</b>	Light, 011-050, 12 String	.....	<b>\$75.99</b>



**JAZZ SWING Series**

<b>JS110</b>	Extra Light, Flat Wound, 010-044	.....	<b>\$48.99</b>
<b>JS111</b>	Light, Flat Wound, 011-047	.....	<b>\$48.99</b>
<b>JS112</b>	Med. Light, Flat Wound, 012-050	.....	<b>\$48.99</b>
<b>JS113</b>	Medium, Flat Wound, 013-053	.....	<b>\$48.99</b>

**JAZZ BEBOP Series**

<b>BB111</b>	Extra Light, Round Wound, 011-047	.....	<b>\$43.99</b>
<b>BB112</b>	Light, Round Wound, 012-050	.....	<b>\$43.99</b>
<b>BB113</b>	Med. Light, Round Wound, 013-053	.....	<b>\$48.99</b>
<b>BB114</b>	Medium, Round Wound, 014-055	.....	<b>\$48.99</b>

# SAVAREZ



<b>"B"</b>	WHITE CARD - LIGHT TENSION	<b>"R"</b>	RED CARD - HIGH TENSION
<b>"J"</b>	YELLOW CARD - VERY HIGH TENSION		
<b>520R</b>	1st, 2nd, 3rd plain, basses wound Red Card .....\$20.65		
<b>520B</b>	1st, 2nd, 3rd plain, basses wound White Card.....20.65		
<b>520J</b>	1st, 2nd, 3rd plain, basses wound Yellow Card.....20.65		
<b>520P</b>	1st plain, 2nd & 3rd wound, basses silver plated copper on nylon Red Card.....24.20		
<b>520P1</b>	Plastic wound trebles, silver wound basses.....27.00		
<b>520P3</b>	1st & 2nd plain, 3rd plastic wound, basses silver plated copper on nylon Red Card.....22.20		
<b>520JR</b>	3 treble plain Yellow Card, Basses wound Red Card .....20.65		
<b>1510MF</b>	Argentine set Loop End Lite .....19.25		
<b>524J</b>	4th String for 520J .....46.80 pk/10		
<b>525J</b>	5th String for 520J .....45.60 pk/10		
<b>ALLIANCE</b>			
<b>540R</b>	Normal Tension .....\$27.75		
<b>540J</b>	High Tension .....27.75		
<b>CORUM</b>			
<b>500AR</b>	Standard Tension, Red Card, Alliance Plain Trebles/ Corum Silver Plated Wound Basses .....\$27.75		
<b>500ARJ</b>	High Tension, Hybrid .....27.75		
<b>500PR</b>	Standard Tension, Red Card, Rectified Nylon Trebles/ Corum Silver Plated Wound Basses .....20.65		
<b>500AJ</b>	High Tension, Blue Card, Alliance Plain Trebles/ Corum Silver Plated Wound Basses .....27.75		
<b>500CJ</b>	Cristal, High Tension, Blue Card.....20.65		
<b>500CR</b>	Cristal, Standard Tension, Red Card .....20.65		
<b>500CRJ</b>	High Tension, Mixed.....20.65		

www.savarez.com

# D'ANGELICO STRING SETS



<b>80/20 SETS</b>		<b>CLASSICAL SETS</b>	
<b>DABWXL</b>	X-Lite.....\$10.50	<b>DA400P</b>	Plain End Brass .....\$12.70
<b>DABWL</b>	Lite.....11.55	<b>DA400B</b>	Ball End Brass .....12.90
<b>DABWM</b>	Medium.....11.55	<b>DA400SC</b>	Plain End Silverplate .....12.70
<b>DA500XL</b>	12 string X-Lite.....18.38	<b>FLATWOUND ELECTRIC SETS</b>	
<b>DA500L</b>	12 string Lite.....19.25	<b>DAFWXL</b>	Lite.....\$16.45
<b>DA500M</b>	12 string Medium.....19.25	<b>DAFWM</b>	Medium .....17.35
<b>PHOSPHOR BRONZE SETS</b>		<b>BANJO SETS (Loop Ends)</b>	
<b>DAPBXL</b>	X-Lite.....\$14.05	<b>DA800L</b>	5 string (light) .....\$6.25
<b>DAPBL</b>	Lite.....12.60	<b>DA800M</b>	5 string (medium) .....6.55
<b>DAPBM</b>	Medium.....12.60	<b>NICKEL ROUND ELECTRIC</b>	
<b>SILK AND STEEL SETS</b>		<b>DA200XL</b>	X-Lite.....\$9.86
<b>DA100SS</b>	6 string.....\$12.55	<b>DA200L</b>	Lite.....9.86
<b>DA500SS</b>	12 string.....19.90		

# KEYSER STRINGS SETS

<b>ACOUSTIC GUITAR STRINGS</b>	
<b>Phosphor Bronze Wound</b>	
<b>KKA1</b>	Extra Light, .010-.048.....\$12.25
<b>KKA2</b>	Light, .011-.046 .....12.25
<b>KKA3</b>	Light/Med., .012-.054.....12.25
<b>ELECTRIC GUITAR STRINGS</b>	
<b>Nickel Plated</b>	
<b>KKE1</b>	Extra Light, .009-.042 .....\$10.25
<b>KKE2</b>	Blue Grass Med., 010-046 .....10.25

www.kysermusical.com

# STEINBERGER



<b>GUITAR</b>	
<b>S942</b>	Extra Light, 009-042.....\$19.85
<b>S946</b>	Light, 009-046 .....19.85
<b>S1046</b>	Regular, 010-046.....19.85
<b>TRANS TREM</b>	
<b>ST1046</b>	Regular, 010-046, Threaded Ball End.....\$23.25
<b>STP946</b>	Light, 009-046, Plain Ball End .....23.25
<b>STP1046</b>	Regular, 010-046, Plain Ball End .....23.25
<b>BASS</b>	
<b>S100L</b>	Extra Light, 040-095 .....\$77.10
<b>S100LS</b>	Soft, 040-102 .....77.10
<b>S100S</b>	Standard Light, 045-105 .....77.10
<b>S100M</b>	Medium, 050-110 .....77.10
<b>S300</b>	Low B, 5 string set .....98.65
<b>S500L</b>	Lite Flatwound .....97.35

www.labella.com

# INFORMATION BOOKS

<b>Acoustic Guitar Owner's Manual – Complete Guide</b>	.....\$17.95
<b>Complete Guitar Repair</b>	.....27.95
<b>Guitar Player Repair Guide (Book &amp; DVD)</b>	.....29.95

# AUGUSTINE CLASSIC STRINGS



<b>AUGB</b>	Blue Label Set High Tension .....\$17.38		
<b>AUGR</b>	Red Label Set Medium Tension .....15.62		
<b>AUGS</b>	Black Label Set (Silver Basses) Low Tension .....13.92		
<b>AUGG</b>	Black Label Set (Gold Basses) Medium Tension .....14.71		
<b>SPECTRA ELECTRIC STRINGS</b>			
<b>SPECL</b>	Spectra Light Set Nickel Plated Steel, 10-46 .....\$10.45		
<b>SPECM</b>	Spectra Medium Set Nickel Plated Steel, 11-48 .....10.45		
<b>SPECLX</b>	Spectra Extra Light Nickel Plated Steel, 9-42 .....10.45		
<b>BLACK LABEL</b>	<b>GOLD LABEL</b>	<b>RED LABEL</b>	<b>BLUE LABEL</b>
<b>BK1st</b>	\$18.00 Dz.	<b>WOUND</b>	<b>WOUND</b>
<b>BK2nd</b>	18.50 Dz.	<b>G4th</b>	\$35.00 Dz.
<b>BK3rd</b>	21.00 Dz.	<b>G6th</b>	48.50 Dz.
<b>S4th</b>	33.00 Dz.	<b>R4th</b>	\$40.00 Dz.
<b>S5th</b>	38.00 Dz.	<b>R5th</b>	42.50 Dz.
<b>S6th</b>	42.50 Dz.	<b>R6th</b>	52.00 Dz.
		<b>B4th</b>	\$42.00 Dz.
		<b>B5th</b>	54.00 Dz.
		<b>B6th</b>	61.00 Dz.

TREBLE STRINGS ARE THE SAME  
ON ALL AUGUSTINE SETS

<b>IMPERIALS</b>	
Truer, richer, more powerful!	
<b>IMP2</b>	Imperial Red .....\$19.12
<b>IMP3</b>	Imperial Blue .....20.92
<b>IMP4</b>	Imperial Gold .....18.21
<b>IMPTR</b>	Imperial Trebles (pack of three) .....7.00/pack
<b>REGALS</b>	
<b>REGR</b>	Regal Red.....\$17.21
<b>REGB</b>	Regal Blue .....19.08

# LA BELLA STRINGS



## ACOUSTIC STRINGS

<b>710L</b>	Silk & Steel Folk (light)	<b>\$22.00</b>
<b>71012L</b>	Silk & Steel 12 string (light)	<b>\$42.20</b>
<b>71012M</b>	Silk & Steel 12 string (medium)	<b>\$42.20</b>
<b>40PT</b>	Sweet Talking Bronze (x-light)	<b>\$17.90</b>
<b>40PS</b>	Sweet Talking Bronze (light)	<b>\$17.90</b>
<b>700C</b>	Cuatro	<b>\$23.90</b>
<b>BL90</b>	Balalaika	<b>\$11.55</b>
<b>ST30</b>	Sitar string set	<b>\$60.15</b>
<b>BZ508</b>	Bouzouki (set of 8)	<b>\$14.25</b>
<b>RQ80</b>	Requinto	<b>\$16.70</b>
<b>17</b>	Banjo, Nylon	<b>\$9.35</b>
<b>260</b>	Plectrum Banjo	<b>\$15.40</b>
<b>OU80</b>	Oud	<b>\$34.55</b>
<b>BGL</b>	Bari Guitar (light)	<b>\$20.95</b>
<b>BX100</b>	Bajo Sexto, 10-String	<b>\$31.30</b>
<b>BX120</b>	Bajo Sexto, 12-String	<b>\$38.35</b>
<b>BG110</b>	Guitar Banjo	<b>\$23.65</b>
<b>C80</b>	Charango	<b>\$13.55</b>
<b>VM300</b>	Vinela De Mexico	<b>\$14.25</b>
<b>GUI</b>	Guitarrone	<b>\$57.15</b>



## ELECTRIC GUITAR

<b>20PL</b>	Flat Wound (light)	<b>\$30.35</b>
<b>20PM</b>	Flat Wound (medium)	<b>\$30.35</b>
<b>8007</b>	7 String, Black Nylon	<b>\$48.00</b>
<b>BGEL</b>	Bari (light)	<b>\$19.80</b>
<b>800L</b>	LT Nylon Tape	<b>\$41.75</b>
<b>800M</b>	MD Nylon Tape	<b>\$41.75</b>



## HARD ROCKIN STEEL ELECTRIC

<b>HRSL</b>	Lite	<b>\$14.00</b>
<b>HRSM</b>	Medium	<b>\$14.00</b>
<b>HR571</b>	7 String 9-64	<b>\$19.35</b>

## BASS (ROUND WOUND)

<b>HRSM40</b>	040, 060, 075, 095	<b>\$55.65</b>
<b>HRSM45B</b>	5 String 45-128	<b>\$76.00</b>

## CLASSIC GUITAR

<b>10PH</b>	High Tension Silver	<b>\$21.65</b>
<b>820</b>	Flamenco	<b>\$18.15</b>
<b>850</b>	Golden Nylon	<b>\$18.15</b>
<b>850B</b>	Black Nylon	<b>\$18.15</b>
<b>860</b>	High Tension	<b>\$20.75</b>
<b>900</b>	Golden Superior	<b>\$18.95</b>
<b>900B</b>	Golden Superior, Black Nylon	<b>\$18.95</b>
<b>413P</b>	Quiet Classic	<b>\$9.75</b>
<b>427</b>	Set of 6 with plain nylon 3rd, Elite	<b>\$17.75</b>
<b>416</b>	E or 1st nylon	<b>\$22.20 dz.</b>
<b>418</b>	B or 2nd nylon	<b>\$23.40 dz.</b>
<b>420</b>	G or 3rd nylon	<b>\$25.80 dz.</b>
<b>422</b>	D or 4th-sil. pltd. wd. on nylon	<b>\$46.10 dz.</b>
<b>424</b>	A or 5th-sil. pltd. wd. on nylon	<b>\$47.40 dz.</b>
<b>426</b>	E or 6th-sil. pltd. wd. on nylon	<b>\$48.00 dz.</b>
<b>830</b>	Nylon, ball end set, Folksinger	<b>\$17.95</b>
<b>831</b>	1st	<b>\$25.80 dz.</b>
<b>832</b>	2nd	<b>\$26.40 dz.</b>
<b>833</b>	3rd	<b>\$29.40 dz.</b>
<b>834</b>	4th	<b>\$43.20 dz.</b>
<b>835</b>	5th	<b>\$44.40 dz.</b>
<b>836</b>	6th	<b>\$46.20 dz.</b>
<b>2001XH</b>	Extra Hard Tension Pro Series Classical	<b>\$21.65</b>
<b>2001MH</b>	Medium Hard Tension Pro Series Classical	<b>\$21.65</b>
<b>2001M</b>	Medium Tension Pro Series Classical	<b>\$21.65</b>
<b>2001L</b>	Light Pro Series Classical	<b>\$21.65</b>
<b>2001F</b>	Medium Flamenco Pro Series Classical	<b>\$21.65</b>



## BASS GUITAR

<b>760FL</b>	Flat Wound (light)	<b>\$85.00</b>
<b>760FLXL</b>	Flat Wound (light) XL	<b>\$85.00</b>
<b>760FS</b>	Flat Wound 45-105	<b>\$85.00</b>
<b>7676F</b>	Flat Wound, 6 String Fender® Bass VI, 026/095	<b>\$131.50</b>
<b>760RL</b>	Round Wound (light)	<b>\$55.65</b>
<b>760RM</b>	Round Wound (medium)	<b>\$55.65</b>
<b>760RM5</b>	Round Wound, 5 String, 044/128	<b>\$76.10</b>
<b>0760M</b>	Jamerson, Flat Wound	<b>\$85.00</b>
<b>760N</b>	Nylon Wound	<b>\$95.75</b>
<b>SS760FL</b>	Short Scale, Flat Wound	<b>\$85.00</b>
<b>SN47CB</b>	Slappers, 6 String	<b>\$81.20</b>
<b>760FHBB</b>	Beatle Bass	<b>\$85.00</b>
<b>760NB</b>	5 String Low B Nylon Wound Bk	<b>\$111.75</b>

## LA BELLA SUPER STEPS



<b>SS45</b>	Bass Guitar 45,65,85,105	<b>\$75.00</b>
<b>SS45B</b>	5 String Bass (Low B)	<b>\$102.00</b>
<b>SS45CB</b>	6 String Bass 29,45,65,85,105,128	<b>\$116.00</b>

www.labela.com

# FENDER STRINGS



## ELECTRIC GUITAR STRINGS

### Original 150's – Pure Nickel

#### Ball End Sets

<b>F150XL</b>	.009 - .040	\$12.00
<b>F150L</b>	.009 - .042	12.00
<b>F150R</b>	.010 - .046	12.00

### Original Bullets – Pure Nickel

#### Bullet End Sets

<b>F3150SL</b>	.008 - .038	\$17.99
<b>F3150XL</b>	.009 - .040	17.99
<b>F3150L</b>	.009 - .042	17.99
<b>F3150TR</b>	.010 - .038	17.99
<b>F3150R</b>	.010 - .046	17.99

### Super 250's – Nickelplated Steel

<b>F250L</b>	.009 - .042	\$10.00
<b>F250R</b>	.010 - .046	10.00
<b>F250RH</b>	.010 - .052	10.00
<b>F250M</b>	.011 - .048	10.00

### Super Bullets – Nickelplated Steel

#### Bullet End Sets

<b>F3250L</b>	.009 - .042	\$14.99
<b>F3250R</b>	.010 - .046	14.99
<b>F3250M</b>	.011 - .049	14.99
<b>ST3250M</b>	.011 - .049	14.99

### Stainless 350's – Stainless Steel

#### Ball End Sets

<b>F350L</b>	.009 - .042	\$9.99
<b>F350R</b>	.010 - .046	9.99

### Stainless Flats – Stainless Steel Flatwound

#### Ball End Sets

<b>F50L</b>	.012 - .052	\$25.00
<b>F50M</b>	.013 - .054	25.00

### Van Halen Premium

<b>EVH942</b>	.009 - .042	\$12.00
<b>EVH946</b>	.009 - .046	\$12.00

## ACOUSTIC GUITAR STRINGS

### 80/20 Bronze Wound

#### Ball End Sets

<b>F70XL</b>	.010 - .048	\$10.50
<b>F70L</b>	.012 - .052	10.50
<b>F70M</b>	.013 - .056	10.50

### Acoustic Bass

#### Phosphor Bronze Wound

<b>F7060</b>	.045 - .095, 30" scale	\$33.00
--------------	------------------------	---------

#### Phosphor Bronze Wound

#### Ball End Sets

<b>F60XL</b>	.010 - .048	\$13.00
<b>F60CL</b>	.011 - .052	13.00
<b>F6012L</b>	12 String	20.00
<b>F60L</b>	.012 - .053	13.00
<b>F60M</b>	.013 - .056	13.00

## CLASSICAL GUITAR STRINGS

### Classical Nylon

#### Tie End Sets

<b>F100</b>	Clear .028 - .043	\$13.00
-------------	-------------------	---------

### Classical Nylon

#### Ball End Set

<b>F130</b>	Clear .028 - .043	\$16.00
-------------	-------------------	---------

## ELECTRIC BASS STRINGS

### Original Bass – Pure Nickel Roundwound

#### Long Scale – 34"

<b>F7150L</b>	.040 - .100	\$46.00
<b>F7150ML</b>	.045 - .100	46.00
<b>F7150M</b>	.045 - .105	46.00

### Short Scale Bass – Nickelplated Steel

#### Short Scale – 30"

<b>F5250XL</b>	.040 - .095	\$40.00
----------------	-------------	---------

### Super Bass – Nickelplated Steel

#### Long Scale – 34"

<b>F7250L</b>	.040 - .100	\$40.00
<b>F7250ML</b>	.045 - .100	40.00
<b>F7250M</b>	.045 - .105	40.00
<b>F7250HM</b>	.050 - .105	40.00
<b>F7250 5L</b>	.040 - .115	50.00
<b>F7250 5M</b>	.045 - .125	50.00
<b>F7250 6M</b>	.030 - .130	50.00

### Super Bass – Nickelplated Steel Taperwound

#### Long Scale – 34"

<b>F8250M</b>	.045 - .110	\$46.00
---------------	-------------	---------

### Stainless Bass – Stainless Steel Roundwound

#### Long Scale – 34"

<b>F7350ML</b>	.045 - .100	\$35.00
<b>F7350M</b>	.045 - .105	35.00

### Stainless Bass – Stainless Steel Flatwound

#### Long Scale – 34"

<b>F9050L</b>	.045 - .095	\$57.00
<b>F9050M</b>	.055 - .105	57.00

### Nylon Tape Wound

#### Long Scale – 34"

<b>F9120</b>	.058 - .110	\$50.00
--------------	-------------	---------

### Pilot Bass – Nickel Plated Steel

#### Long Scale – 35"

<b>F72506M</b>	.030 - .130, 6 String	\$57.99
----------------	-----------------------	---------



## TITLES FROM OUR MUSIC DEPARTMENT

**Guitar Identification** – Reference Guide to Serial Numbers For Dating the Guitars of Fender, Gibson, Martin and Gretsch .....**\$12.95**

**Leonard Guitar Method Bk. 1** .....**6.99**

**Leonard Guitar Method Bk. 1 Bk/CD** .....**10.99**

**Leonard Guitar Method Bk. 1 Bk/CD/DVD**.....**24.99**

**Leonard Guitar Method Bk. 1 DVD Video** ....**19.95**

# AQUILA NYLUT UKULELE SETS / CLASSICAL SETS

Until the mid-20th century Ukuleles were mounted exclusively in gut, a material that had been used for thousands of years and that combines excellent promptness of attack with brilliance of timbre – very different, in other words, from modern nylon strings. And until recently the typical sound quality of gut has been a constant point of reference for luthiers, composers and performers alike.

A fundamental aim of our research has therefore been to make a new synthetic product having the same acoustic properties as gut – but without its typical defects – (high cost, limited duration and high instability under varying climatic).

**Red Series** sets provide performance over traditional strings for musicians who love clear, sharp sounds and powerful voicing across the full scale of the instrument. The strings also maintain their intonation better.



## Soprano

1U	Soprano Regular Tuning, Key of C (all true gut strings) GCEA.....	<b>\$19.39</b>
4U	Soprano Regular Tuning, Key of C (all Nylgut® strings) GCEA.....	<b>9.42</b>
5U	Soprano Low-G Tuning, Key of C (1 wound string) GCEA.....	<b>9.97</b>
30U	Soprano Fifths Tuning GDAE like mandolin (1 x G wound string).....	<b>9.97</b>
33U	Soprano Regular Tuning, Key of D (all Nylgut® strings) ADF#B.....	<b>9.42</b>
34U	Soprano Low-G Tuning, Key of D (1 wound string) ADF#B.....	<b>9.97</b>
83U	Soprano regular, key of C GCEA, <b>Red Series</b> .....	<b>10.10</b>
84U	Soprano Low-G, Key of C, GCEA, <b>Red Series</b> , (no wound strings), .39 inches.....	<b>10.80</b>
100U	Soprano Regular High-G, <b>Super Nylgut</b> , Key of C, GCEA, plain.....	<b>10.10</b>
101U	Soprano Low-G, <b>Super Nylgut</b> , Key of C, GCEA, plain (1 red).....	<b>10.80</b>
57U	Soprano Regular High-G, <b>Bionylon</b> , Key of C, GCEA, plain.....	<b>6.80</b>
58U	Soprano Low-G, <b>Bionylon</b> , Key of C, GCEA, 1 wound.....	<b>7.80</b>
44U	Single packaged 4th Soprano mandolin fifths tuning.....	<b>3.18</b>
6U	Single packaged 4th Soprano Low G tuning.....	<b>3.18</b>
35U	Single packaged 4th Soprano Low A tuning.....	<b>3.18</b>

## Concert

7U	Concert Regular Tuning, Key of C (all Nylgut® strings) GCEA.....	<b>\$9.42</b>
8U	Concert Low-G Tuning, Key of C (1 wound string) GCEA.....	<b>9.97</b>
36U	Concert Low-G Tuning, Key of C (2 wound strings) GCEA.....	<b>10.94</b>
31U	Concert Fifths Tuning, CGDA like Viola da Braccio (2 wound strings).....	<b>10.94</b>
85U	Concert Regular, Key of C, GCEA, <b>Red Series</b> .....	<b>10.10</b>
86U	Concert Low-G Key of C, GCEA, <b>Red Series</b> , (no wound strings).....	<b>10.80</b>
55U	Concert High, <b>Nylgut</b> , Key of C, GCEA, (1 red) the 3rd.....	<b>9.97</b>
59U	Concert Regular High-G, <b>Bionylon</b> , Key of C, GCEA, plain.....	<b>6.80</b>
103U	Concert Regular High-G, <b>Super Nylgut</b> , Key of C, GCEA, plain.....	<b>10.10</b>
104U	Concert Low-G, <b>Super Nylgut</b> , Key of C, GCEA, plain (1 red).....	<b>10.80</b>
31U	Concert In Fifths, Mandola Tuning, <b>Nylgut</b> , CGDA, 2 wound.....	<b>10.39</b>
46U	Concert 4th Mandola Tuning C, <b>Nylgut</b> , CGDA, wound.....	<b>2.50</b>
60U	Concert Low-G, <b>Bionylon</b> , Key of C, GCEA, 1 wound.....	<b>7.06</b>
45U	Single Packaged 3rd Concert Viola Fifths Tuning.....	<b>3.18</b>
37U	Single Packaged 3rd Concert GCEA Tuning (2 wound).....	<b>3.18</b>
46U	Single Packaged 4th Concert Viola Fifths Tuning.....	<b>3.18</b>
9U	Single Packaged 4th Concert Low G Tuning.....	<b>3.18</b>
38U	Single Packaged 4th Concert Low G Tuning (2 wound).....	<b>3.18</b>
77U	Single packaged 3rd unwound Concert High G/Low G tuning, <b>Red Series</b> .....	<b>3.18</b>

## Tenor

10U	Tenor Regular Tuning, Key of C (all Nylgut® strings) GCEA.....	<b>\$9.42</b>
13U	Tenor Regular Tuning, Key of C (1 wound string) GCEA.....	<b>9.97</b>
15U	Tenor Low-G Tuning, Key of C (1 wound string) GCEA.....	<b>9.97</b>
39U	Tenor Low-G Tuning, Key of C (2 wound strings) GCEA.....	<b>10.52</b>
87U	Tenor Regular, Key of C, GCEA, <b>Red Series</b> .....	<b>10.10</b>
88U	Tenor, Low-G, key of C, GCEA, <b>Red Series</b> , (no wound strings).....	<b>10.80</b>
11U	Tenor High D Tuning (1 wound string) DGBE.....	<b>9.97</b>
17U	Tenor 6 Strings, Key of C, 1 wound string (LIL'U) GCEA.....	<b>12.19</b>
19U	Tenor 8 strings, Key of C, 1 wound string (LIL'U) GCEA.....	<b>13.57</b>
63U	Tenor High-G, <b>Bionylon</b> , Key of C, GCEA, plain.....	<b>6.80</b>
65U	Tenor Low-G, <b>Bionylon</b> , Key of C, GCEA, 1 wound.....	<b>7.06</b>
106U	Tenor High-G, <b>Super Nylgut</b> , Key of C, GCEA, plain.....	<b>10.10</b>
107U	Tenor Low-G, <b>Super Nylgut</b> , Key of C, GCEA, plain (1 red).....	<b>10.80</b>
14U	Single Packaged 3rd Tenor, GCEA Tuning (1 wound).....	<b>3.32</b>
40U	Single Packaged 3rd Tenor, GCEA Tuning (2 wound).....	<b>3.32</b>
12U	Single Packaged 3rd Tenor, DGBE Tuning.....	<b>3.18</b>
18U	Single Packaged 1st 6 Strings Tenor, GCEA Tuning.....	<b>3.32</b>
41U	Single Packaged 4th Tenor, GCEA Tuning (2 wound).....	<b>3.32</b>

16U	Single Packaged 4th Tenor, Low G Tuning.....	<b>3.32</b>
78U	Single packaged 3rd unwound Tenor High G/Low G tuning, <b>Red Series</b> .....	<b>3.18</b>
80U	Single packaged 3rd unwound 6 string Tenor, <b>Red Series</b> .....	<b>3.18</b>
81U	Single packaged 3rd unwound 8 string Tenor, <b>Red Series</b> .....	<b>3.18</b>
75U	Single packaged 1st A unwound Tenor 6 strings, <b>Red Series</b> , .38 inches.....	<b>3.18</b>
76U	Single packaged 4th G unwound Tenor 8 strings, <b>Red Series</b> , .39 inches.....	<b>3.18</b>

## Baritone

89U	Baritone 4 DGBE tuning, <b>Red Series</b> , (wound G & C).....	<b>\$11.65</b>
	Baritone <b>Red Series</b> has two wound and two reds.	
23U	Baritone 4 Strings, GCEA Tuning.....	<b>9.42</b>
21U	Baritone 4 Strings, EBGD Tuning.....	<b>10.94</b>
24U	Baritone 6 Strings, DGBE Tuning.....	<b>15.23</b>
26U	Baritone 8 Strings, DGBE Tuning.....	<b>18.83</b>
24U	Baritone 6 String, DGBE (Low D), 2 red.....	<b>15.24</b>
108U	Baritone Single, 3rd G for 6 + 8, plain, <b>Red Series</b> .....	<b>2.63</b>
109U	Baritone Single, 4th D for 6 + 8, plain, <b>Red Series</b> .....	<b>2.77</b>
49U	Single Packaged 3rd Baritone, EBGD Tuning.....	<b>3.46</b>
73U	Single packaged 3rd G unwound Baritone, DGBE tuning, <b>Red Series</b> .....	<b>3.18</b>
50U	Single Packaged 3rd, 6 String Baritone.....	<b>3.46</b>
51U	Single Packaged 3rd 8 String Baritone.....	<b>3.46</b>
22U	Single Packaged 4th Baritone, EBGD Tuning.....	<b>3.46</b>
25U	Single Packaged 4th 6 String Baritone.....	<b>3.46</b>
27U	Single Packaged 4th 8 String Baritone.....	<b>3.46</b>

## Bass

68U	Bass Uke Thunder Gut, very dense elastic plastic blend, GDAE.....	<b>\$33.23</b>
91U	4 Strings Thunder Reds Bass Uke Set, GDAE, (all the strings are <b>Red Series</b> ).....	<b>52.60</b>
69U	5 String Thundergut Bass Uke Set, GDAEB, (4 gut-color Thundergut strings, the B string is a <b>Red Series</b> type).....	<b>37.40</b>
92U	Short Bass basic model set (12 joint frets), GDAE, (all the strings are <b>Red Series</b> type).....	<b>58.15</b>
93U	Red Series Set, '14' model set (14 joint frets), GDAE, (all the strings are <b>Red Series</b> type).....	<b>62.30</b>

## Classical Guitar

A1C	Alchemia Normal Tension.....	<b>\$34.36</b>
A2C	Alchemia Superior Tension.....	<b>34.36</b>
19C	Alabastro Normal Tension.....	<b>17.30</b>
20C	Alabastro Superior Tension.....	<b>17.30</b>
37C	Perla Normal Tension.....	<b>16.50</b>
38C	Perla Superior Tension.....	<b>16.50</b>

## Banjo Ukulele (Banjouke)/Banjo/Mandolin

43U	Banjo Ukulele (all gut strings) GCEA Tuning.....	<b>\$30.46</b>
42U	Banjo Ukulele (all Nylgut®) GCEA Tuning.....	<b>9.42</b>
28U	Banjo Ukulele (1 wound) GCEA Tuning.....	<b>10.52</b>
90U	Banjo Ukulele, GCEA, <b>Red Series</b> , (no wound strings).....	<b>10.10</b>
29U	Single Packaged 3rd Banjo.....	<b>3.46</b>
79U	Single packaged 3rd unwound Banjouke, <b>Red Series</b> .....	<b>3.18</b>
AQ5B	Banjo, Medium.....	<b>11.50</b>
6B	Banjo, Lite.....	<b>11.50</b>
11B	Red Series Banjo 5 String Normal Tension.....	<b>12.35</b>
A1M	Mandolin Nylgut, G wound medium.....	<b>13.85</b>

## BLACK DIAMOND

N754XL	Extra Light Gauge, Acoustic	\$15.15
N754L	Light Gauge, Acoustic	15.15
N754M	Medium Gauge, Acoustic	15.15
N75412L	12 String Light Gauge, Acoustic	24.00
N477XL	Extra Light Gauge, Electric	11.05
N477L	Light Gauge, Electric	11.05
N734L	5-String Banjo, Ball End	8.85
N73412L	5-String Banjo, Loop End	8.60
N762	Mandolin, Loop End	14.35

### 80/20 BRASS

N8020L	Light Gauge	\$12.50
N8020M	Medium Gauge	12.50

### CLASSIC AND FOLK GUITAR

N68	Classic, Clear Trebles, Normal Tension	\$13.85
N68B	Clear Trebles, Ball End	13.85
N168B	Folk Black Trebles, Ball End	12.85

### PHOSPHOR BRONZE

N600L	Light Gauge	\$13.60
N600M	Medium Gauge	13.60

### FLAT WOUND

N200L	Light	\$22.90
N300ML	Bass 45-100	74.33

### BLACK COATED, PHOSPHOR BRONZE

N600XLB	Xtra Light	\$29.10
N600LB	Light	29.10
N600MB	Medium	29.10

### BLACK COATED, Electric

N477XLB	Xtra Light	\$20.80
N477LB	Light	20.80
N477MB	Medium	20.80

[www.blackdiamondstrings.com](http://www.blackdiamondstrings.com)

## FLOYD ROSE STRINGS



SLS1009	Speedloader Strings	.009-.042	\$29.99
SLS1009LH	Speedloader Strings	.009-.046	29.99
SLS1010	Speedloader Strings	.010-.046	29.99
SLS1010LH	Speedloader Strings	.010-.056	29.99

## EVERLY STRINGS

### ELECTRIC ROCKERS

E9009	0.009	0.011	0.016	0.024	0.032	0.042	\$10.99
E9019	0.009	0.011	0.016	0.026	0.036	0.046	10.99
E9010	0.010	0.013	0.017	0.026	0.036	0.046	10.99
E9011	0.011	0.014	0.018	0.028	0.038	0.048	10.99
E9111	X Rocker	11/52					13.99
E9112	X Rocker	12/60					13.50

### ELECTRIC B52 ROCKERS

E9209	0.009	0.011	0.016	0.024	0.032	0.042	\$14.99
E9219	0.009	0.011	0.016	0.026	0.036	0.046	14.99
E9210	0.010	0.013	0.017	0.026	0.036	0.046	14.99

### ACOUSTIC SESSIONS (PHOS BRONZE)

E7210	0.010	0.014	0.024	0.030	0.038	0.047	\$15.50
E7211	0.011	0.014	0.023	0.030	0.038	0.048	15.50
E7212	0.012	0.016	0.025	0.033	0.043	0.053	15.50

### E7213 0.013 0.017 0.026 0.036 0.046 0.056 \$15.50RED

### BRAND ACOUSTIC COPPER BRONZE

E7311	Custom Light	11/52	\$17.00
E7312	Light	12/53	17.00
E7313	Medium	13/56	17.00

[www.everlymusic.com](http://www.everlymusic.com)

## KEN SMITH BASS STRINGS

### THE MASTER SERIES - ROUND WOUND

KSSMUL	Slap Masters	Ultra-Light	.030 .050 .070 .090	\$48.00
KSSMSL	Slap Masters	Super-Light	.035 .055 .075 .095	48.00
KSSMXL	Slap Masters	Extra-Light	.040 .060 .075 .095	48.00
KSRML	Rock Masters	Light	.040 .060 .080 .100	48.00
KSRMML	Rock Masters	Medium-Light	.045 .065 .080 .100	48.00
KSRMM	Rock Masters	Medium	.045 .065 .085 .105	48.00
KSMMLH	Metal Masters	Light-Heavy	.050 .070 .080 .100	48.00
KSMMMH	Metal Masters	Medium-Heavy	.050 .070 .085 .105	48.00
KSMMH	Metal Masters	Heavy	.050 .070 .085 .110	48.00

### CUSTOM BALANCED ROUND WOUND

KSRWL	RWL	Round Wound	.040 .058 .080 .102	\$48.00
KSRWLM	RWL-M	Round Wound	.040 .058 .084 .106	48.00
KSRWML	RWM-L	Round Wound	.044 .063 .080 .102	48.00

### BASS BURNERS - ROUND WOUND, NICKEL

KSBBXL	Extra-Light	.040/.060/.075/.095	\$48.00	
KSBBL	Light	.045/.060/.080/.100	48.00	
KSBBML	Medium-Light	.045/.065/.080/.100	48.00	
KSBBM	Medium	.045/.065/.085/.105	48.00	
KSRWMS	RWM-S	Short Scale	.044 .063 .084 .106	48.00
KSRWMM	RWM-M	Medium Scale	.044 .063 .084 .106	48.00
KSTCRL	TCRL	Taper Core Round	.040 .058 .084 .102	57.60
KSTCRML	TCRM-L	Taper Core Round	.044 .063 .080 .102	57.60
KSTCRM	TCRM	Taper Core Round	.044 .063 .084 .106	57.60
KSTCRM5	5 STG	Taper Core Round		76.80

### SLICK ROUNDS

KSSRL	SRL	Light	.040/.056/.077/.103	\$52.80
KSSRM	SRM	Medium	.045/.065/.085/.105	52.80
KSSRML	SRML	Medium Light	.045/.065/.080/.100	52.80

### THE COMPRESSOR BASS SERIES

KSCRML	CRM-L	Compression Wound	.044 .062 .080 .102	\$52.80
KSCRM	CRM	Compression Wound	.044 .062 .082 .105	52.80

### THE MASTER SERIES - 5 & 6 STRING ROUND WOUND BASS.

KSRWVL	Metal Masters	5 Stg. Low B	\$69.60
KSRMM5T	Rock Masters	5 Stg. Med	69.60
KSRMM6T	Rock Masters	6 Stg. Med	76.80

### LOW B's

KST120	\$24.00	KSR100	\$14.00	KST028	\$9.60
KST125	24.00	KSR120	20.00	KST030	9.60
KST130	24.00	KSR125	20.00	KST035	9.60
KST145	24.00	KSR130	20.00		
		KSR140	20.00		

[www.kensmithbasses.com](http://www.kensmithbasses.com)

## CLEARTONE STRINGS

CT9409	Electric	.009-.042	\$22.00
CT9410	Electric	.010-.046	22.00
CT9411	Electric	.011-.048	22.00
CT9456	Drop D	11/56	19.00
CT9460	Drop C#	12/60	19.00
CT9470	Drop C	12/70	19.00
CT7410	Acoustic	.010-.047	24.00
CT7411	Acoustic	.011-.052	24.00
CT7412	Acoustic	.012-.054	24.00
CT7413	Acoustic	.013-.056	24.00
CT7423	Acoustic, Bluegrass		24.00
CT741012	Acoustic, 12 String		44.00

### 80/20

CT7611	.011-.052	\$21.00
CT76121	.012-.053	21.00
CT7613	.013-.056	21.00

## FAMOUS 351 STRINGS

SE3519	Electric	.009-.042	\$ 3.80
SE35110	Electric	.010-.046	3.80
SA35112	Acoustic	.012-.053	3.80
SC3515P	Classical, Clear/Silver		3.80
SB35145	Bass	.045-.105	14.20

## DUNLOP STRINGS

### ACOUSTIC GUITAR – 80/20 BRONZE

DAB1048	Extra Light, 10-14-22-30-40-48 .....	\$13.25
DAB1152	Medium Light, 11-15-22-32-42-52 .....	13.25
DAB1254	Light, 12-16-24-32-42-54 .....	13.25
DAB1356	Medium, 13-17-26-36-46-56 .....	13.25

### ACOUSTIC GUITAR – PHOSPHOR BRONZE

DAP1048	Extra Light, 10-14-22-30-40-48 .....	\$13.25
DAP1152	Medium Light, 11-15-22-32-42-52 .....	13.25
DAP1254	Light, 12-16-24-32-42-54 .....	13.25
DAP1356	Medium, 13-17-26-36-46-56 .....	13.25

### UKULELE STRINGS

Made with a proprietary blend of nylon monofilament.

DUY201	Uke Soprano Student 4/Set, 20-30-32-22 .....	\$6.99
DUY301	Uke Soprano Pro 4/Set, 22-32-34-24 .....	7.99
DUY302	Uke Concert Pro 4/Set, 28-32-43-28 .....	7.99
DUY303	Uke Tenor Pro 4/Set, 29-33-41-29 .....	7.99
DUY304	Uke Baritone Pro 4/Set, 28-34-30W-35W .....	8.99

### ZAKK WYLDE ICON SERIES

ZWN1046	Electric Medium, 10-13-17-26-36-46 .....	\$11.00
ZWN1060	Electric Custom, 10-13-17-36-52-60 .....	11.00
ZWP1254	Acoustic Phosphor Light, 12-16-24-32-42-54 .....	15.50

### REV. WILLY'S MEXICAN LOTTERY BRAND GUITAR STRINGS

RWN0738	Super Fine, Nickel Plated Steel, 7-9-11-20W-30-38 .....	\$10.99
RWN0840	Fine, Nickel Plated Steel, 8-10-12-20W-30-40 .....	10.99
RWN0942	Light, Nickel Plated Steel, 9-11-16-24-32-42 .....	10.99
RWN1046	Medium, Nickel Plated Steel, 10-13-17-26-36-46 .....	10.99

### ELECTRIC GUITAR – PURE NICKEL

DEK0942	Pure Nickel Light 6/Set, 9-11-16-24-32-42 .....	\$12.75
DEK1046	Pure Nickel Medium 6/Set, 10-13-17-26-36-46 .....	12.75
DEK1052	Pure Nickel Light/Heavy 6/Set, 10-13-17-30-42-52 .....	12.75
DEK1150	Pure Nickel Medium/Heavy 6/Set, 11-14-18-28-38-50 .....	12.75

### ELECTRIC GUITAR – NICKEL PLATED STEEL

DEN0838	Extra Light, 8-11-16-24-30-38 .....	\$9.55
DEN0942	Light, 9-11-16-24-32-42 .....	9.55
DEN0946	Light Top Heavy Bottom 9's, 9-11-16-26-36-46 .....	9.55
DEN1046	Medium, 10-13-17-26-36-46 .....	9.55
DEN1052	Light Top Heavy Bottom 10's, 10-13-17-30-42-52 .....	9.55
DEN1150	Medium Heavy, 11-14-18-28-38-50 .....	9.55
DEN1254	Heavy, 12-16-24-32-42-54 .....	9.55
DEN1356	Extra Heavy, 13-17-26-36-46-56 .....	9.55

### BASS – NICKEL PLATED STEEL

DBN40100	Light, 40-60-80-100 .....	\$37.50
DBN40120	Light 5 String, 40-60-80-100-120 .....	48.50
DBN45100	Medium Light, 45-65-80-100 .....	37.50
DBN45105	Medium, 45-65-85-105 .....	37.50
DBN45125	Medium for 5 String, 45-65-85-105-125 .....	48.50
DBN45130	Medium for 5 String w/130, 45-65-85-105-130 .....	48.50
DBN50110	Heavy, 50-70-90-110 .....	37.50
DEN1056	7 String M/L, 10-13-17-26-36-46-56 .....	13.50
DEN0965	8 String, 09-11-16-24-32-42-54-65 .....	14.99
DEN1074	8 String, 10-13-17-30-42-54-64-74 .....	14.99

### BASS – LEMMY KILMISTER STRINGS – STAINLESS STEEL

LKS50105	50-70-85-105 .....	\$46.00
----------	--------------------	---------

### SUPER BRIGHT™ NICKEL WOUND BASS STRINGS

DBSBN40100	Light 40-60-80-100 .....	\$37.50
DBSBN40120	Light, 5 String 40-60-80-100-120 .....	48.50
DBSBN45105	Medium 45-65-85-105 .....	37.50
DBSBN45125	Medium, 5 String 45-65-85-105-125 .....	48.50

### SUPER BRIGHT™ STEEL BASS STRINGS

DBSBS40100	Light 40-60-80-100 .....	\$37.50
DBSBS40120	Light, 5 String 40-60-80-100-120 .....	48.50
DBSBS45105	Medium 45-65-85-105 .....	37.50
DBSBS45125	Medium, 5 String 45-65-85-105-125 .....	48.50

## JOHN PEARSE STRINGS

### NAUGES

JP2810LM	Light Medium .....	\$18.95
----------	--------------------	---------

### SIX STRING GUITAR – ACOUSTIC

#### 80/20 BRONZE

JP100XL	Extra Light .....	\$12.45
JP150	New Standard .....	12.45
JP200L	Light .....	12.45
JP250LM	Bluegrass .....	12.45
JP300M	Medium .....	12.45
JP310NM	New Medium .....	12.45
JP300M	Medium .....	12.45
JP3260L	Light Bartitone Guitar .....	18.95
JP3280M	Medium Bartitone Guitar .....	20.45

### PHOSPHOR BRONZE

JP 500XL	Extra Light .....	\$12.95
JP 550SL	Slite Lite .....	12.95
JP 600L	Light .....	12.95
JP650LM	Bluegrass .....	12.95
JP700M	Medium .....	12.95
JP710NM	New Medium .....	12.95
JP800	Slack Key Guitar .....	12.95

### PHOSPHOR BRONZE & SILK

JP510L	Light Silks .....	\$18.95
JP610LM	Light/Medium Silks .....	18.95

### SIX STRING GUITAR – CLASSICAL SILVER PLATED WOUND

JP1100	Standard Tension .....	\$11.95
JP1200	Firm Tension .....	13.95

### SIX STRING GUITAR – ELECTRIC NICKEL WOUND

JP2400	Super EZ Bend .....	\$9.95
JP2500	EZ Bend .....	9.95

### 6 STRING GUITAR – ACOUSTIC/ELECTRIC NICKEL WOUND

JP960L	Lite .....	\$11.95
JP2600	Jazz Light .....	11.65
JP2700	Jazz Medium .....	11.65

### 12 STRING GUITAR – ACOUSTIC 80/20 BRONZE

JP1300L	Light .....	\$19.95
---------	-------------	---------

### FIVE STRING BANJO – EXTRA LONG

JP1700L	Light – Bronze .....	\$7.65
JP1800M	Medium – Nickel .....	7.65

### MANDOLIN – 80/20 BRONZE

JP2100M	Standard .....	\$12.95
JP2200H	Heavy .....	12.95

### RESOPHONIC GUITAR – NICKEL

JP3000	"G" Tuning .....	\$12.35
JP3050	Dobro .....	11.45
JP3250	Open "E" Tuning .....	20.95

### PLUCKED DULCIMER – BRONZE

JP5000	4 String .....	\$6.75
--------	----------------	--------

### ELECTRIC BASS GUITAR – ROUNDWOUND NICKEL

JP6000	Light – Long Scale .....	\$33.50
JP6100	Medium – Long Scale .....	33.50

### THOMASTIK – JOHN PEARSE GUITAR

JPPJ116	Silverplated/Nylon Wound .....	\$24.65B
---------	--------------------------------	----------

### VIOLIN – PERLON CORE

JP4500	.....	\$39.25B
--------	-------	----------

### VIOLIN – "ARTISTE" SERIES

JP3500	Mezzo .....	\$39.25B
--------	-------------	----------

### FIDDLE

JP4100	.....	\$35.00B
--------	-------	----------

### UKULELE – SOPRANO

JP5100	.....	\$27.90B
--------	-------	----------

www.jpstrings.com

# GHS STRINGS



## ELECTRIC GUITAR

### SUPER STEELS Roundwound Stainless Steel

GHSSTXL	Super Steels, XL, 009.....	\$11.28
GHSSTL	Super Steels, LT, 010.....	11.28

### PROGRESSIVES Roundwound Alloy 52

GHSPRXL	Extra Light.....	\$13.60
GHSPRCL	Custom Light.....	13.60
GHSPRL	Light.....	13.60
GHSPRDM	Dave Mustaine.....	13.60
GHSPRM	Medium.....	13.60
GHSPRH	Heavy.....	13.60

### REINFORCED BOOMERS Roundwound Nickel-Plated Steel

GHSTGBL	Tremo Boom, 010.....	\$10.95
GHSTGBXL	Tremo Boom, 009.....	10.95

### BOOMERS Roundwound Nickel-Plated Steel

GHSGBUL	Boomers, UL, 008.....	\$9.75
GHSGB8 1/2	Boomers, UL +1/2.....	9.75
GHSGBXL	Boomers, XL, 009.....	9.75
GHSGB9 1/2	Boomers, XL + 1/2.....	9.75
GHSGBCL	Boomers, CL, 009.....	9.75
GHSGBLXL	Boomers, LT, EX-LT.....	9.75
GHSGBL	Boomers, LT, 010.....	9.75
GHSGB10 1/2	Boomers, LT + 1/2.....	9.75
GHSGBTM	Boomers True Med, 11-50.....	9.75
GHSGBM	Boomers, MD, 011.....	9.75
GHSGBTNT	Boomers, THIN/THICK.....	9.75
GHSGBH	Boomers, HVY.....	9.75
GHSGBDGF	David Gilmour Blue.....	9.75
GHSGBDGG	David Gilmour Red.....	9.75
GHSDYXL	Dynamite Alloy, EX-LT.....	10.97
GHSDYL	Dynamite Alloy, LT.....	10.97
GHSDYM	Dynamite Alloy, MD.....	10.97
GHSGBZW	Dynamite Alloy, 10-60.....	10.97
GHSGBZWLO	Dynamite Alloy, 11-70.....	10.97
GHSLEGBXL	Loop End Boomers, XL.....	12.08
GHSLEGBL	Loop End Boomers, LT.....	12.08
GHSGB7L	7 String Boomers, XL, 009-58.....	12.75
GHSGB7CL	7 String Boomers, CL, 009-62.....	12.75
GHSGB7M	7 String Boomers, MD, 010-60.....	12.75
GHSGB7MH	7 String Boomers, MH, 011-64.....	12.75
GHSGB7H	7 String Boomers, H, 013-74.....	12.75
GHSGBXL8	8 String Boomers, 009-72.....	15.75
GHSGBCL8	8 String Boomers, 009-74.....	15.75
GHSGBL8	8 String Boomers, 010-76.....	15.75
GHSGBTNT8	8 String Boomers, 010-80.....	15.75
GHSGBH8	8 String Boomers, 011-85.....	15.75
GHSGBLOW	Lo-Tune.....	9.75

### COATED BOOMERS

CBGBXL	Boomers, XL, 009.....	\$17.85
CBGBCL	Boomers, CL, 009.....	17.85
CBGBL	Boomers, LT, 010.....	17.85
CBGBM	Boomers, MD, 011.....	17.85
CBBTNT	Boomers, THIN/THICK, 010.....	17.85
CBGBH	Boomers, HVY, 012.....	17.85

### SUB-ZERO BOOMERS

#### Roundwound Cryogenically Treated Nickel-Plated Steel

GHSRCGBUL	Sub-Zero Boomers ULT.....	\$13.17
GHSRCGBXL	Sub-Zero Boomers XLT.....	13.17
GHSRCGBCL	Sub-Zero Boomers CL.....	13.17
GHSRCGBL	Sub-Zero Boomers LT.....	13.17
GHSRCGBM	Sub-Zero Boomers M.....	13.17

### 12-STRING ELECTRIC GUITAR BOOMERS Roundwound Nickel-Plated Steel

GHSGB12L	12 String Guitar Boomer, 010.....	\$16.75
GHSGB12XL	12 String Guitar Boomer, 009.....	16.75

### BURNISHED NICKEL Roundwound Pure Nickel

GHSBNRXL	Burnished Pure Nickel, Round XL.....	\$13.07
GHSBNRL	Burnished Pure Nickel, Round L.....	13.07
GHSBNRM	Burnished Pure Nickel, Round M.....	13.07

## ELECTRIC GUITAR

### NICKEL ROCKERS Roundwound Pure Nickel

GHSRRUL	N Rock, UL, 008.....	\$11.86
GHSRRXL	N Rock, XL, 009.....	11.86
GHSRRXL/L	N Rock, XL/LT.....	11.86
GHSRRL	N Rock, LT, 010.....	11.86
GHSREJL	EJ Light, 010-50.....	14.17
GHSREJM	EJ Light, 011-52.....	14.17
GHSRRM	N Rock, MD, 011.....	14.17
GHS1300	Lo Tune Roller Nickel.....	15.84
GHS1315	Nickel, LT.....	13.63
GHS1400	Nickel, MD LT.....	16.74
GHS1500	Nickel, TR MED.....	13.70

### COMPOUND NICKEL Roundwound

GHS1800	LT.....	\$18.90
GHS1810	MED.....	20.55

### BRITE FLATS Ground Roundwound Alloy 52

GHS700	XL.....	\$16.96
GHS710	LT.....	18.43
GHS720	MED.....	22.68
GHS730	REG.....	25.82

### PRECISION FLATWOUND Flat Wrap Stainless Steel

GHS750	Flatwound, UL.....	\$22.42
GHS800	Flatwound, XL.....	25.82
GHS900	Flatwound, LT.....	28.35
GHS1000	Flatwound, MED.....	28.93

### DOUBLE BALL END Roundwound Nickel-Plated Steel

GHSDBGXL	Stnbnr Guitar, Boom, 009.....	\$16.80
GHSDBGBL	Stnbnr Guitar, Boom, 010.....	16.80

## ELECTRIC BASS

### CONTACT CORE SUPER STEELS Roundwound Stainless Steel

Standard Long Scale (Fits 34" Scale)

GHSL5200	Contact Core, Standard Long, LT.....	\$45.15
GHSM5200	Contact Core, Standard Long, MD.....	49.34
GHS5LCC	5 String, Contact Core, LT.....	65.51

### BIG CORE BASS

A hybrid of stainless steel and nickel-iron wraps

GHS4RMB	Med.....	\$47.66
GHS5RMB	5-String Med.....	68.35

### Super Steels

GHSXL5000	Super Steels, Long +, X-LT.....	\$38.59
GHSL5000	Super Steels, Long +, LT.....	44.19
GHSML5000	Super Steels, Long +, ML.....	44.19
GHSCL5000	Super Steels, Long +, Custom MD.....	45.31
GHSML5000	Super Steels, Long +, MD.....	44.19
GHS5MLSTB	5-String, Super Steels, ML.....	55.60
GHS6LSTB	6-String, Super Steels, LT.....	62.37

### PROGRESSIVES Roundwound Alloy 52

Standard Long Scale (Fits 34" Scale)

GHSL8000	Progressives Bass, LG.....	\$44.85
GHSML8000	Progressives Bass, MD.....	47.65

### BASS BOOMERS Roundwound Nickel-Plated Steel

GHSB3045	Bass, Boom, Long +, PIC.....	\$22.00
GHSB3045X	Bass, Boom, Long +, XL.....	40.89



# GHS STRINGS



## ELECTRIC BASS

<b>BOOMERS</b>	
GHSML3045X	X Long, ML .....\$40.89
GHSML3045	Std. Lng., MD .....\$40.89
GHS5MCDYB	5-String Bass, Hi C, LS.....\$44.63
GHS8LSDYB	8-String Bass, RG SCL.....\$57.75
GHSXL3045	Std. Lng., XL .....\$40.89
GHSL3045	Std. Lng., LT .....\$40.89
GHSL3045X	X Long, LT .....\$40.89
GHSML3045	Std. Lng., ML .....\$40.89
GHSML3045	Std. Lng., MD .....\$40.89
GHSML3045F	Std. Lng., MD, Flea Signature Set .....\$40.89
GHSH3045	Std. Lng., HVY.....\$40.89
GHS5LDYB	5-String, LT.....\$51.45
GHS5MLDYB	5-String, ML.....\$51.45
GHS5MDYB	5-String, MED.....\$51.45
GHS6MLDYB	6-String, ML.....\$57.75
GHS3140	MD SCL, ML.....\$40.89
GHS3040	MD SCL, REG .....\$40.89
GHS3135	Short, LT .....\$40.89
GHS3035	Short, REG .....\$40.89

### COATED BOOMERS

CBL3045	Bass, Std. Lng., LT .....\$68.25
CBML3045	Bass, Std. Lng., ML .....\$68.25
CBM3045	Bass, Std. Lng., MD.....\$68.25

### SUB-ZERO BOOMERS

#### Roundwound Cryogenically Treated Nickel-Plated Steel

Long Scale Plus (Fits 34", 35", 36" Scale)

CRL3045	Sub-Zero Bass Boomers .....\$47.50
CRML3045	Sub-Zero Bass Boomers .....\$47.50
GHSCRM3045	Sub-Zero Bass Boomers .....\$47.50

### BASSICS Roundwound Nickel-Plated Steel

Standard Long Scale (Fits 34" Scale)

GHSL6000	Bass, Basics, Std. Lng., LT .....\$30.45
GHSML6000	Bass, Basics, Std. Lng., ML .....\$30.45
GHM6000	Bass, Basics, Std. Lng., MD .....\$30.45

### PRESSUREWOUND Pressurewound Alloy 52

Standard Long Scale (Fits 34" Scale)

GHSL7200	Pressurewound, Std. Lng., LT.....\$51.03
GHSML7200	Pressurewound, Std. Lng., ML.....\$51.03
GHSML7200	Pressurewound, Std. Lng., MD .....\$51.03
GHS7500	Pressurewound, MD SCL, LT .....\$48.78
GHS7700	Pressurewound, Short, LT .....\$48.78

### BRITE FLATS Long Scale Plus

Long Scale Plus (Fits 34", 35", 36" Scale)

GHSL3075	Brite Flats, Long +, LT.....\$51.03
GHSML3075	Brite Flats, Long +, ML.....\$51.03
GHSML3075	Brite Flats, Long +, MD .....\$51.03
GHS3065	Brite Flats, MD SCL, REG.....\$51.03
GHS3070	Brite Flats, Short, REG .....\$51.03

### PRECISION FLATWOUND Flatwound Stainless Steel

Long Scale Plus (Fits 34", 35", 36" Scale)

GHS3025	Flatwound, Long, LT .....\$55.60
GHSML3050	Flatwound, Long +, MED .....\$55.60
GHS3050	Flatwound, Long +, REG .....\$55.60
GHS3020	Flatwound, Short, REG.....\$55.60

### TAPEWOUND Tapewound Black Nylon

GHS3060	Bass, Black Nylon Tape .....\$57.75
GHS3060S	5-String Bass .....\$73.45

### DOUBLE BALL ENDS Roundwound Stainless Steel

GHS5610	Stnogr. Bass, Roundwound, EX-LT.....\$45.68
GHS5600	Stnogr. Bass, Roundwound, LT .....\$45.68
GHS5630	Stnogr. Bass, Roundwound, MD .....\$45.68
GHS5LDBB	Bass, 5-String Stnogr., LT.....\$45.68

### ACOUSTIC/ELECTRIC BASS

GHSL9000	Phos. Bronze, Long, LT .....\$40.85
----------	-------------------------------------

## SIGNATURE SETS

### CARLOS SANTANA'S BIG CORE

GHSBCXL	XLight	.0095	.0115	.016	.025	.033	.043	.....\$13.60
GHSBCL	Light	.0105	.0135	.018	.028	.038	.048	.....\$13.60
GHSBCM	Medium	.0115	.015	.019	.028	.038	.056	.....\$13.60
GHSBCL	Custom Light	.0095	.0115	.016	.028	.038	.048	.....\$13.60

### ERIC JOHNSON NICKEL ROCKERS

GHSREJL	Light Gauge Set.....\$14.17
GHSREJM	Medium Gauge Set .....\$14.17

### FLEA SIGNATURE BASS BOOMERS

GHSML3045-F	Bass Boom, Std. Lng., MD, Flea Signature Set.....\$40.89
-------------	--

### DAVE MUSTAINE SIGNATURE PROGRESSIVES

GHSPRDM	Progressives Dave Mustaine.....\$13.60
---------	--

### SIGNATURE BRONZE - LAURENCE JUBER

GHSJL20X	Extra Light.....\$16.00
GHSJL30L	True Light.....\$16.00
GHSJL40TM	True Medium .....\$16.00
GHSJL40M	Medium .....\$16.00

## CLASSICAL GUITAR STRINGS

### VANGUARD CLASSICS Pure Nickel Smoothwound

GHS2500	Nickel Classics .....\$19.72
GHS2510	Classics Wound - 3rd.....\$21.42

### LA CLASSIQUE Nylon Trebles/Winter Silver Bases

GHS2300	MD HI .....\$17.33
GHS2300G	Grnd., MD HI .....\$16.99
GHS2370	HI .....\$17.33
GHS2370G	Grnd., HI .....\$16.99
GHS2350	Wnd. 3rd, HI .....\$17.33
GHS2380	Super HI .....\$18.80
GHS2390	Smoothwound.....\$18.80
GHSDD2300	Doyle Dykes .....\$15.85

### CLASSICAL GUITAR

#### Tie End Regular Classics

GHS2150W	Classical Guitar, Tie, Clear/Silver .....\$13.12
GHS2100W	Classical Guitar, Tie, Clear/Bronze.....\$12.71

### BALL END REGULAR CLASSICS

GHS2050W	Classical Guitar, Ball, Silver .....\$16.69
GHS2000	Classical Guitar, Ball, Bronze.....\$16.22

## MANDOLIN FAMILY

### BRIGHT BRONZE

GHS2050	Mandolin, Bright Bronze, ML .....\$12.70
GHS2000	Mandolin, Bright Bronze, MED.....\$12.70

### PHOSPHOR BRONZE

GHS2050	Classic Mandolin, 9-32 .....\$13.17
GHS2050	Mandolin, Phosphor Bronze, LT .....\$13.17
GHS2050	Mandolin, Osborne, Phosphor Bronze, ML .....\$13.17
GHS2050	Mandolin, Phosphor Bronze, MD .....\$13.17

### STAINLESS STEEL Electric or Acoustic

GHS2500	Mandolin, Stainless Steel, LT .....\$14.28
---------	--

### SILK AND STEEL

GHS2500	Mandolin, Silk/Steel, LT .....\$16.49
---------	---------------------------------------

### SILK AND BRONZE

GHS2500	Silk & Bronze Mandolin .....\$16.02
---------	-------------------------------------

### MANDOLA 8-String Set Bright Bronze

GHS2050	Mandola 8-String Bright Bronze .....\$15.07
---------	---

### OCTAVE, MANDOLIN & STRING Phosphor Bronze

GHS2050	Octave Mandolin, Phosphor .....\$18.75
---------	--

# GHS STRINGS



## ACOUSTIC GUITAR STRINGS

### CONTACT CORE BRIGHT BRONZE 80/20 Copper Zinc

GHSCCBB10	Bronze, 10-46 .....	\$14.65
GHSCCBB20	Bronze, 11-50 .....	14.65
GHSCCBB30	Bronze, 12-54 .....	14.65
GHSCCBB40	Bronze, 13-56 .....	14.65

### BRIGHT BRONZE 80/20 Copper Zinc

GHSBB10U	Bright Bronze, UL .....	\$13.83
GHSBB20X	Bright Bronze, XL .....	13.83
GHSBB30L	Bright Bronze, LT .....	13.83
GHSBB40M	Bright Bronze, MED .....	13.83
GHSBB50H	Bright Bronze, HVY .....	13.83
GHSBB60X	12-String, Bright Bronze, XL .....	18.75
GHSBB80	12-String, Bright Bronze, LT .....	19.69
GHSBB100	12-String, Bright Bronze, MED .....	19.69

### SIGNATURE BRONZE

GHSLJ20X	Extra Light .....	\$15.43
GHSLJ30L	True Light .....	16.00
GHSLJ40TM	True Medium .....	16.00
GHSLJ40M	Medium .....	16.00

### WHITE BRONZE

GHSWBXL	White Bronze, EX LT .....	\$15.31
GHSWBTL	White Bronze, TR LT .....	15.31
GHSWBL	White Bronze, STD LT .....	15.31
GHSWBM	White Bronze, MED .....	16.48
GHSWB12L	12-String, White Bronze, LT .....	24.41

### PHOSPHOR BRONZE Copper-Tin-Phosphor Alloy

GHSS315	Phosphor Bronze, XL .....	\$14.92
GHSS325	Phosphor Bronze, LT .....	14.92
GHSTM335	Phosphor Bronze, TR MED .....	14.92
GHSS335	Phosphor Bronze, MED .....	14.92
GHS340	Phosphor Bronze, HVY .....	14.80
GHSDDS325	Doyle Dykes, LT .....	15.38
GHS605	12-String, Phosphor Bronze, XL .....	20.95
GHS615	12-String, Phosphor Bronze, LT .....	22.00
GHS625	12-String, Phosphor Bronze, MED .....	22.63

### INFINITY BRONZE

GHSIB20X	Extra Light .....	\$20.89
GHSIB30L	Light .....	20.89
GHSIB40M	Medium .....	20.89

### VINTAGE BRONZE 85/15 Copper Zinc

GHSVNUL	Vintage Bronze, UL .....	\$11.76
GHSVNXL	Vintage Bronze, XL .....	11.76
GHSVNL	Vintage Bronze, LT .....	11.76
GHSVNB	Vintage Bronze, Bluegrass .....	11.76
GHSVNM	Vintage Bronze, MD .....	11.76
GHSVN12CL	Custom Light, 12-String .....	18.75
GHSVN12L	12-String, Vintage Bronze, LT .....	18.75

### SILK AND STEEL Silver-Plated Copper

GHS345	Silk/Steel, LT .....	\$16.53
GHS350	Silk/Steel, MED .....	16.53
GHS600	12-String, Silk/Steel, LT .....	23.16
GHS610	12-String, Silk/Steel, MED .....	24.82

### SILK AND BRONZE Copper-Tin-Phosphor Alloy

GHS370	Silk & Bronze, LT .....	\$16.53
GHS370ML	Silk & Bronze, ML .....	16.02
GHS370-12L	Silk & Bronze 12-String .....	24.25

## BANJO AND SLIDE GUITAR STRINGS

### 5-STRING BANJO Phosphor Bronze

GHS PF150	Phosphor Bronze, LT .....	\$7.45
GHS PF160	Phosphor Bronze, MD .....	7.45
GHS PF135	Crowe Stage, LT, .010 .....	7.66
GHS PF140	Crowe Studio, LT, .095 .....	7.66
GHS PF145	Stainless Steel, M/L .....	7.66
GHS PF155	Stainless Steel, C/L .....	7.66
GHS PF170	Stainless Steel, LT .....	7.66
GHS PF185	Almost MED .....	7.66
GHS PF175	Osborne, ML .....	7.66
GHS PF180	Stainless Steel, MED .....	7.66
GHS PF130	Ball End, LT .....	7.66
GHS PF120	6-String Banjo, Ball End, Stainless Steel LT .....	12.50

### 4-STRING BANJO Tenor / Plectrum (Loop End)

GHS220	Tenor Banjo, Stainless Steel, LT .....	\$7.97
GHS210	Tenor Banjo, Phosphor Bronze, LT .....	7.72
GHS230	Tenor Banjo, Baier, MED .....	8.82
GHS190	Plectrum Banjo, Stainless Steel, LT .....	6.57

### ACOUSTIC SLIDE GUITAR (DOBRO TYPE)

#### White Bronze Roundwound – G Tuning

GHS DWB1600	White Bronze Slide/Reso. ....	\$16.86
GHS TS1600	Tim Scheerhorn Signature Set Cryo .....	15.44
GHS SH1600	Infinity Bronze Coated .....	21.95
GHS1650	Dobro Roundwound, Phosphor Bronze .....	14.34
GHS RB1600	Dobro Rollerwound, Bronze .....	14.34
GHS1600	Roller, Nickel Slide/Reso. ....	18.06

### ELECTRIC HAWAIIAN LAP STEEL

#### Dynamic Alloy – E Tuning

GHS LAPE	Lap Steel Guitar, E Tuning .....	\$11.19
----------	----------------------------------	---------

## PEDAL STEEL GUITAR STRINGS

### SUPER STEEL Stainless Steel Roundwound

GHS STE9	Super Steel, E9th .....	\$15.49
----------	-------------------------	---------

### BOOMERS Nickel-Plated Steel Roundwound

GHS GBE9	Boomers, E9th .....	\$14.65
GHS GBC6	Boomers, C6th .....	19.69

### PEDAL STEEL GUITAR Pure Nickel Rollerwound

GHS PF500	Semi-Flat, E9th .....	\$16.96
GHS PF550	Semi-Flat, C6th .....	28.35

## UKULELE STRINGS

### STANDARD UKULELE – Clear Nylon

GHS10	Standard Ukulele .....	\$4.60
-------	------------------------	--------

### HAWAIIAN UKULELE (Concert/Standard), Black Nylon

GHS H10	Hawaiian Ukulele .....	\$4.46
---------	------------------------	--------

### HAWAIIAN TENOR UKULELE

GHS HT10	Hawaiian Tenor Ukulele .....	\$6.03
----------	------------------------------	--------

### HAWAIIAN LIL'U 6-STRING

GHS HL6	Hawaiian Lil'u 6-String Ukulele .....	\$9.03
---------	---------------------------------------	--------

### BARITONE UKULELE

GHS100	Baritone Ukulele .....	\$7.72
--------	------------------------	--------

### HAWAIIAN BARITONE UKULELE

GHS H100	Hawaiian Baritone Ukulele .....	\$10.19
----------	---------------------------------	---------

# GHS STRINGS



## OTHER INSTRUMENTS

### FIDDLE

**GHS4000F** Fiddle, Chromium Lat., Plain E.....\$65.10

### UPRIGHT BASS

**GHS4100** Upright Bass.....\$279.00

### DULCIMER

**GHSD20** Dulcimer.....\$6.57

**GHSD20M** Dulcimer Loop End.....6.57

### BAJO SEXTO

**GHSBSX10** Bajo Sexto, 10-String.....\$30.40

**GHSBSX12** Bajo Sexto, 12-String.....40.27

**GHSBSX1** 1st Pair .....4.81

**GHSBSX2** 2nd Pair .....4.81

**GHSBSX3** 3rd Pair .....6.09

**GHSBSX4** 4th Pair .....6.09

**GHSBSX5** 5th Pair .....7.47

**GHSBSX6** 6th Pair .....9.56

### BOUZOUKI 8-STRING (GREEK)

**GHSBZ8** Bouzouki Loop, Silverwound .....\$11.88

### CUATRO 10-STRING

**GHS CPR10** Cuatro 10-string .....\$16.49

## GHS SINGLE STRINGS

### PLAIN STEEL GUITAR – REGULAR BALL END

**GHS008** Plain Steel Single String .....\$14.04 dz.

**GHS008 1/2** Plain Steel Single String.....14.04 dz.

**GHS009** Plain Steel Single String.....14.04 dz.

**GHS009 1/2** Plain Steel Single String.....14.04 dz.

**GHS010** Plain Steel Single String.....14.04 dz.

**GHS0810 1/2** Plain Steel Single String.....14.04 dz.

**GHS011** Plain Steel Single String.....14.04 dz.

**GHS011 1/2** Plain Steel Single String.....14.04 dz.

**GHS012** Plain Steel Single String.....14.04 dz.

**GHS013** Plain Steel Single String.....14.04 dz.

**GHS013 1/2** Plain Steel Single String.....14.04 dz.

**GHS014** Plain Steel Single String.....14.04 dz.

**GHS015** Plain Steel Single String.....14.04 dz.

**GHS016** Plain Steel Single String.....14.04 dz.

**GHS017** Plain Steel Single String.....14.04 dz.

**GHS018** Plain Steel Single String.....14.04 dz.

**GHS019** Plain Steel Single String.....14.04 dz.

**GHS020** Plain Steel Single String.....14.04 dz.

**GHS021** Plain Steel Single String.....14.04 dz.

**GHS022** Plain Steel Single String.....14.04 dz.

**GHS024** Plain Steel Single String.....14.04 dz.

**GHS026** Plain Steel Single String.....14.04 dz.

### DYNAMITE ALLOY (BOOMERS)

**GHS DY16** Boomer Single String .....\$13.26/6

**GHS DY18** Boomer Single String .....13.26/6

**GHS DY20** Boomer Single String .....13.26/6

**GHS DY22** Boomer Single String .....13.26/6

**GHS DY24** Boomer Single String .....13.26/6

**GHS DY26** Boomer Single String .....13.26/6

**GHS DY28** Boomer Single String .....13.62/6

**GHS DY30** Boomer Single String .....13.62/6

**GHS DY32** Boomer Single String .....13.62/6

**GHS DY34** Boomer Single String .....13.62/6

**GHS DY36** Boomer Single String .....13.62/6

**GHS DY38** Boomer Single String .....13.92/6

**GHS DY40** Boomer Single String .....13.92/6

**GHS DY42** Boomer Single String .....13.92/6

**GHS DY44** Boomer Single String .....13.92/6

**GHS DY46** Boomer Single String .....13.92/6

**GHS DY48** Boomer Single String .....13.92/6

**GHS DY50** Boomer Single String .....13.92/6

**GHS DY52** Boomer Single String .....13.92/6

**GHS DY54** Boomer Single String .....13.92/6

**GHS DY56** Boomer Single String .....13.92/6

**GHS DY58** Boomer Single String .....14.58/6

**GHS DY60** Boomer Single String .....14.58/6

**GHS DY74** Boomer Single String.....27.78/6

### BASS BOOMERS

#### Standard Long Scale (for 34" Scale)

**GHS DYB30** Single Bass String .....\$5.38 ea.

**GHS DYB40** Single Bass String .....7.18 ea.

**GHS DYB45** Single Bass String .....7.18 ea.

**GHS DYB50** Single Bass String .....7.18 ea.

**GHS DYB55** Single Bass String.....9.68 ea.

**GHS DYB65** Single Bass String.....9.68 ea.

**GHS DYB70** Single Bass String.....9.68 ea.

**GHS DYB75** Single Bass String .....10.89 ea.

**GHS DYB80** Single Bass String .....10.89 ea.

**GHS DYB85** Single Bass String .....10.89 ea.

**GHS DYB90** Single Bass String .....13.39 ea.

**GHS DYB95** Single Bass String .....13.39 ea.

**GHS DYB100** Single Bass String .....13.39 ea.

**GHS DYB105** Single Bass String .....13.39 ea.

**GHS DYB110** Single Bass String .....13.39 ea.

**GHS DYB115** Single Bass String .....13.39 ea.

**GHS DYB120** Single Bass String .....13.39 ea.

**GHS DYB126** Single Bass String .....13.39 ea.

**GHS DYB130** Single Bass String .....13.39 ea.

**GHS DYB135** Single Bass String .....13.39 ea.

**GHS DYB140** Single Bass String .....13.39 ea.

**GHS DYB145** Single Bass String .....13.39 ea.

# ELIXIR STRINGS

## ACOUSTIC

### Ultra-Thin NANOWEB® Coating (80/20)

E11002	Extra Light	.010/.047	\$30.00
E11027	Custom Light	.011/.052	30.00
E11052	Light	.012/.053	30.00
E11182	HD Light/Taylor	.013/.053	30.00
E11077	Light-Medium	.012/.056	30.00
E11102	Medium	.013/.056	30.00
E11152	12-String Light	.010/.047	48.00
E11172	12-String Medium	.012/.053	48.00
E11162	12-String Heavy	.013/.056	48.00

### Original PolyWEB® Coating (80/20)

E11000	Extra Light	.010/.047	\$30.00
E11025	Custom Light	.011/.052	30.00
E11050	Light	.012/.053	30.00
E11075	Light-Medium	.012/.056	30.00
E11100	Medium	.013/.056	30.00
E11125	Resonator	.016/.056	30.00
E11150	12-String Light	.010/.047	48.00

## ELECTRIC

### Ultra-Thin NANOWEB® Coating

E12002	Super Light	.009/.042	\$22.00
E12027	Custom Light	.009/.046	22.00
E12052	Light	.010/.046	22.00
E12077	Light-Heavy	.010/.052	22.00
E12102	Medium	.011/.049	22.00
E12152	Heavy	.012/.052	22.00
E12302	Baritone	.012/.068	22.00
E12450	12 String Light	.010/.047	40.00
E12057	7 String Light	.010/.056	30.00

### Original PolyWEB® Coating

E12000	Super Light	.009/.042	\$22.00
E12050	Light	.010/.046	22.00

## BARITONE

### Ultra-Thin NANOWEB® Coating (80/20)

E11306	6-String	.016/.070	\$40.00
E11308	8-String	.016/.070	46.00

## MANDOLIN

### Ultra-Thin NANOWEB® Coating

E11500	Light	.010/.034	\$26.00
E11525	Medium	.011/.040	26.00

## BANJO

### Original POLYWEB® Coating

E11600	Light	.009/.009	\$17.35
E11650	Medium	.010/.010	17.35

## BASS

### Ultra-Thin NANOWEB® Coating

E14002	4-String Super Light/Long	.040/.095	\$82.50
E14052	4-String Light/Long	.045/.100	82.50
E14077	4-String Medium/Long	.045/.105	82.50
E14087	4-String Medium/Extra Long	.045/.105	82.50
E14102	4-String Heavy/Long	.050/.105	82.50
E14502	4-String Acoustic Light/Long	.045/.100TW	82.50
E14202	5-String Light/Long	.045/.130TW	102.00

## BASS SINGLE STRINGS

### NANOWEB® Coating

Make your own 5 & 6 string custom sets by adding these singles to your bass sets.

E15332	.032	\$14.00
E15340	.040	20.00
E15345	.045	20.00
E15350	.050	20.00
E15360	.060	20.00
E15365	.065	20.00
E15370	.070	20.00
E15375	.075	20.00
E15380	.080	20.00
E15385	.085	20.00
E15395	.095	20.00
E15400	.100	20.00
E15401	.100 XL	20.00
E15405	.105	20.00
E15425	.125	20.00
E15430	.130	20.00
E15431	.130 XL	20.00
E15432	.130 TW	20.00
E15433	.130XL T/W	20.00



Elixir® Strings last 3-5 times longer than ordinary strings without compromising tone. This means you buy fewer sets of strings, change them less often, and trust that your guitar is ready to go whenever you are. Coating prevents contamination and corrosion from collecting in the windings of the strings.

## ACOUSTIC

### Phosphor Bronze NANOWEB® Coating

E16002	Extra Light	.010/.047	\$34.00
E16027	Custom Light	.011/.052	34.00
E16052	Light	.012/.053	34.00
E16077	Light-Medium	.012/.056	34.00
E16102	Medium	.013/.056	34.00
E16182	HD Light/Taylor	.013/.053	34.00

## STAINLESS STEEL ELECTRIC BASS

E14652	4-String Light/Long Scale	.045/.100	\$80.00
E14677	4-String Medium/Long Scale	.045/.105	80.00
E14777	5-String Medium w/Light B/Long Scale	.045/.130	100.00
E14877	5-String Med. w/Super Light B/Long Scale	.045/.125	100.00

## SINGLE STRINGS

### Plain Steel Strings Anti-Rust

	Gauge	4/Pack
E13009	.009	\$8.00
E13010	.010	8.00
E13011	.011	8.00
E13012	.012	8.00
E13013	.013	8.00
E13014	.014	8.00
E13015	.015	8.00
E13016	.016	8.00
E13017	.017	8.00
E13018	.018	8.00
E13022	.022	8.00

## ACOUSTIC GUITAR SINGLE STRINGS

Nanoweb	Polyweb	4/Pack	Gauge	Ph/Brnz	4/Pack
E15122	E13122	\$29.00	.022	E14122	\$35.52
E15123	E13123	29.00	.023	E14123	35.52
E15124	E13124	29.00	.024	E14124	35.52
E15126	E13126	29.00	.026	E14126	35.52
E15127	E13127	29.00	.027	E14127	35.52
E15128	E13128	29.00	.028	E14128	35.52
E15130	E13130	29.00	.030	E14130	35.52
E15132	E13132	29.00	.032	E14132	35.52
E15135	E13135	29.00	.035	E14135	35.52
E15139	E13139	29.00	.039	E14139	35.52
E15142	E13142	29.00	.042	E14142	35.52
E15145	E13145	29.00	.045	E14145	35.52
E15147	E13147	29.00	.047	E14147	35.52
E15152	E13152	29.00	.052	E14152	35.52
E15153	E13153	29.00	.053	E14153	35.52
E15156	E13156	29.00	.056	E14156	35.52
E15159	E13159	29.00	.059		

## ELECTRIC GUITARS SINGLE STRINGS

Nanoweb	Polyweb	Gauge	4/Pack
E15224	E13224	.024	\$29.00
E15226	E13226	.026	29.00
E15228	E13228	.028	29.00
E15232	E13232	.032	29.00
E15236	E13236	.036	29.00
E15238	E13238	.038	29.00
E15242	E13242	.042	29.00
E15246	E13246	.046	29.00
E15249	E13249	.049	29.00
E15252	E13252	.052	29.00
E15256	E13256	.056	29.00
E15268	E13268	.068	29.00

## TUNING FORKS



Clear tone, longer sound and accurate tuning. Special quality steel, polished and plated.

### WITTNER

<b>920A</b>	Size 3" long, round prongs.....	<b>\$7.25</b>
<b>920C</b>	Size 3" long, round prongs.....	<b>7.25</b>
<b>921A</b>	Size 4" long, round prongs.....	<b>8.20</b>
<b>921BF</b>	Size 4" long, round prongs.....	<b>15.80</b>
<b>921C</b>	Size 4" long, round prongs.....	<b>9.70</b>
<b>921E</b>	Size 4" long, round prongs.....	<b>9.70</b>
<b>921G</b>	Size 4" long, round prongs.....	<b>16.20</b>
<b>922A</b>	Size 4 1/2" square prongs.....	<b>12.60</b>
<b>924A</b>	Size 5" long, square prongs.....	<b>20.10</b>
<b>924E</b>	Size 5 1/2" long, square prongs.....	<b>24.85</b>
<b>W924SET</b>	Chromatic Set C-C 13 Forks.....	<b>327.45</b>



### PLANET WAVES

<b>PWTFA</b>	A440 .....	<b>\$17.35</b>
<b>PWTFE</b>	E329.6 .....	<b>17.35</b>

## CHROMATIC PITCH PIPES



Master key pitch pipes with note selector attached.

<b>MK1S</b>	F to F .....	<b>\$33.60</b>
<b>MK2S</b>	C to C .....	<b>33.60</b>
<b>NS1</b>	Note Selector Only .....	<b>4.50</b>

Master key chromatic pitch pipes.

<b>MK1</b>	F to F .....	<b>\$31.50</b>
<b>MK2</b>	C to C .....	<b>31.50</b>
<b>MK3</b>	Eb to Eb.....	<b>31.50</b>

### BECKER/PERFORMANCE PLUS

<b>BCPPC</b>	C to C w/Selector.....	<b>\$11.45</b>
<b>BCPPF</b>	F to F w/Selector .....	<b>11.45</b>
<b>PPCPC</b>	C to C .....	<b>14.10</b>
<b>PPCPF</b>	F to F.....	<b>14.10</b>
<b>PG016</b>	Chromatic C to C .....	<b>11.65</b>

## PITCH PIPES



### KRATT PITCH PIPES

<b>KRATTSN3</b>	Violin/Mandolin .....	<b>\$20.55</b>
<b>KRATTSN10</b>	Spanish Guitar .....	<b>24.75</b>
<b>KRATTSN6</b>	Tenor Banjo/Cello/Viola .....	<b>20.55</b>
<b>KRATTSN5</b>	Uke, G, C, E, A.....	<b>20.55</b>
<b>SN8</b>	Banjo, G, C, G, B, D.....	<b>23.25</b>
<b>SN11</b>	Bluegrass Banjo, G, D, G, B, D.....	<b>23.25</b>
<b>SN12</b>	12 String, D, G, C, F, A, D.....	<b>22.50</b>
<b>SN13</b>	Dulcimer, D, G.....	<b>10.50</b>
<b>2S10</b>	Guitar.....	<b>23.40</b>
<b>2S3</b>	Violin .....	<b>13.95</b>

### SINGLE NOTE PITCH PIPES

<b>SN1A</b>	Key of A .....	<b>\$5.55</b>
<b>SN1C</b>	Key of C .....	<b>5.55</b>
<b>SN1E</b>	Key of E.....	<b>5.55</b>

### PITCH PIPES

<b>GP1</b>	Guitar, Conser Varte .....	<b>\$8.50</b>
<b>GP6</b>	Guitar.....	<b>4.40</b>
<b>PG013</b>	Plastic Guitar .....	<b>6.10</b>
<b>BGPP</b>	Guitar, Becker .....	<b>5.45</b>
<b>BVCPP</b>	T Banjo, Cello, Becker .....	<b>3.85</b>
<b>BVMPP</b>	Violin, Becker .....	<b>5.09</b>
<b>PV013</b>	Plastic Violin .....	<b>4.05</b>
<b>KAYVP4</b>	Violin .....	<b>4.70</b>
<b>9340</b>	Violin, Becker (Metal Pipes) .....	<b>10.50</b>
<b>CP4</b>	Cello, Viola, T Banjo .....	<b>4.70</b>
<b>PV013C</b>	Cello, Viola, T Banjo .....	<b>4.05</b>
<b>UP4P</b>	Plastic Uke .....	<b>5.25</b>
<b>PG013U</b>	Uke Plastic.....	<b>3.75</b>

## FINGERBOARD OIL/CLEANER



<b>TP11</b>	Trick Fretboard Cleaner .....	<b>\$5.75</b>
<b>LSFC</b>	Lizard Spit Cleaner .....	<b>13.60</b>
<b>PWFBC</b>	Planet Waves Hydrate.....	<b>7.15</b>
<b>PWFRP</b>	Fret Polishing System, 5 Sheets .....	<b>10.20</b>
<b>RT71</b>	Fingerboard Oil, 2 oz.....	<b>4.95</b>
<b>PN2590</b>	Alsyn, Fingerboard Oil .....	<b>7.15</b>
<b>BL301</b>	Treated String Cleaning Cloth .....	<b>5.60</b>
<b>GHSA8</b>	String Cleaning/Conditioning Cloth .....	<b>4.15B</b>
<b>GLC104</b>	Fretboard Conditioner .....	<b>12.50</b>
<b>BBFBJ</b>	Fretboard Juice.....	<b>5.45</b>
<b>SW101</b>	The Swipe -1 Each String and Neck and Body Cleaner.....	<b>7.85</b>

## POLISHES/CLEANERS

### REFLECTION



Works on everything. No wax build up.  
**RSE1** .....

### BIG BENDS



String Wipes, 25 Pack	
<b>BBGSW</b>	..... <b>\$6.28</b>
<b>50BBGSW</b>	..... <b>8.48</b>
<b>BBESR</b>	Encore Scratch Remover..... <b>12.45</b>
<b>BBP</b>	2 oz. Glass Sauce Polish..... <b>6.25</b>

### GHS GUITAR GLOSS



<b>GHSA92</b>	..... <b>\$7.30B</b>
---------------	----------------------

### LIZARD SPIT



Perfect for use on metal, plastics as well as painted, lacquered (including nitrocellulose) and varnished wood. Lizard Spit is specially formulated for ease of use.

<b>LSGP</b>	..... <b>\$11.50</b>	
<b>LSSL</b>	String Glide/Lube .....	<b>11.50</b>

### FINGER EASE



Sprays on guitar strings to reduce friction. Applies a silicone residue that lubricates the strings.

<b>FE220</b>	..... <b>\$5.85 ea.</b>
--------------	-------------------------

### FAST FRET



<b>GHSA87</b>	..... <b>\$7.79B</b>
<b>GHSA8</b>	String Cloth..... <b>4.15B</b>

## DUNLOP GUITAR PACKS/GIG PACKS



Tortex® .60 mm Pick. Nylon .60 mm Pick. Shell Classic Medium Pick. Dunlop Pick Holder. Dunlop String-winder. 100% Cotton Polish Cloth. Formula No. 65 Polish Cloth & Cleaner. Dunlop Trigger Capo. Chrome Slide.  
**GA20** .....

Tortex® .60 mm Pick. Nylon .60 mm Pick. Shell Classic Medium Pick. Dunlop Pick Holder. Dunlop String-winder. 100% Cotton Polish Cloth & Cleaner. Dunlop Elastic Capo. Chrome Slide. Lok Strap Cable. Lok Strap Retainers (2)  
**GA50** .....



The Acoustic Pack contains 3 sets of DAP1254 acoustic strings, one chromed slide, one elastic capo and a PVP102 Player's Pack with 12 assorted picks.

<b>GA24</b>	Acoustic Gig Pack.....	<b>\$57.82</b>
-------------	------------------------	----------------



The Electric Pack contains two sets of DEN1046 electric strings, one D38-09 black strap, and a PVP Player's Pack with 12 assorted picks.

<b>GA54</b>	Electric Gig Pack.....	<b>\$45.79</b>
-------------	------------------------	----------------

# POLISHES/CLEANERS

## D'ANDREA



- Pump Spray Polish  
**DAP4** .....\$6.60  
 Polishing Cloth  
**PC1215PL** 12" x 15" .....2.85  
 Lemon Oil Conditioner  
**DAL2** .....6.00  
**DAPC1** Polish Cloth .....3.85

## GLAS POLISH

4 oz. bottle of concentrated guitar polish by Ken Smith.



- KSGP** .....\$ 6.00  
**KSCP** Classic Wax  
 Polish .....8.10B

## GROOVIN GLOW



- High Gloss Polish  
**GJGG** .....\$6.95

## MR. C's DETAILER

- Cleans & polishes  
**MCP** .....\$7.55

## GUITAR HONEY



- Number one Carnuba wax  
**GNO** .....\$7.95  
 Fingerboard treatment  
**GGH** .....7.95  
 Smudge Off  
**GSO** .....7.95

## BIG BENDS



- Microfiber Polishing Cloth  
**AXSW** .....\$7.98  
 Scratch Remover  
**BBESR** .....12.45

## PLANET WAVES



### STEP 1: RESTORE - Deep-Cleaning Cream Polish

Planet Waves' new RESTORE deep-cleaning cream polish is a rich formula designed to cut through the toughest grime. Safe on all common guitar finishes.

- PWPL01** Restore Polish .....\$10.20

### STEP 2: PROTECT - Pure Liquid Carnuba Wax

Planet Waves' new PROTECT is a natural protectant and sealer combining premium-quality, #1 yellow Brazilian Carnuba and advanced chemistry to produce a distinct radiance with quick and easy application.

- PWPL02** Protect Wax .....\$10.20

### STEP 3: SHINE - Spray Cleaner & Maintainer

Planet Waves' new SHINE spray cleaner and maintainer keeps your finish looking like new every day. SHINE erases dust, fingerprints, and minor imperfections, while color enhancers bring out your finish's beauty.

- PWPL03** Shine Spray .....\$10.20

### String Cleaner

Cleans and lubricates strings to remove dirt and grease which can cause corrosion and tone loss.

- PWSTC** String Cleaner .....\$6.15



### Polish Packets

Each packet contains a one-time use quantity of each polish in the 3-step detailing system.

- PWPK** .....\$4.10



### PRE-TREATED POLISH CLOTH

Produced with cleaner built into the cloth so there is no need for extra polish.

- PWPCI** .....\$8.70

### UNTREATED POLISH CLOTH

Made from high-quality double napped cotton flannel, which picks up dust and dirt more effectively.

- PWPC2** .....\$7.65



### Hydrate

Hydrate is the ultimate treatment to restore the character of dark, natural wood fingerboards. This unique formula of oils and cleaners removes dirt and grime while restoring moisture.

- PWFBC** .....\$7.15



### MICRO-FIBER POLISH CLOTH

Traps particles inside the fiber.

- PWMPC** .....\$11.25  
**OH7** Oasis .....6.95

## DUNLOP Formula 65



- 654** Polish & Cleaner .....\$7.36  
**654C** Polish & Cleaner Cloth.....10.42  
**6574** Carnuba Wax .....8.72



- 6582** String Cleaner .....\$5.95  
**DUN6524** Fingerboard Cleaner .....6.34  
**6532** Fingerboard Deep  
 Conditioner .....6.34  
**6554** Lemon Oil .....6.34  
**651J** 1oz Polish & Cleaner .....3.90  
**6516** 16oz Polish & Cleaner.....19.79  
**DUN5400** Cloth .....3.56



### CARE KITS

- 6500** Guitar Maintenance Kit ....\$42.45  
**6501** Guitar Care Kit .....17.91  
**6502** Fingerboard Care Kit .....17.55



- 6503** Lemon Oil/Polish .....\$22.53  
**6504** Tech Kit .....35.18

## POLISHES/CLEANERS

### GHS GUITAR GLOSS



Non-wax revitalizing treatment for deep, clear, long-lasting shine on musical instruments.

**GHSA92** 4 oz.....\$7.30B

### FAST FRET



Not a spray! Contains no silicone. It's a liquid in an applicator. Use it on strings, fretboard, back of neck.

**GHSA87** .....\$7.79B

**GHSA8** String Cloth .....4.15B

### GHS GORGOMYTE CLOTH

Fret and fingerboard cleaning and conditioning cloth.

**GHSA6** .....\$19.90B

### SIT



Liquid polish good for all fine wood instruments.

**SITPOLISH** .....\$6.00

### D'ANDREA CARE KITS



Acousticare Kit Contains: polishing cloth, string winder, pick sampler, and wood care guide.

**DANAC1** .....\$23.35

Kit Contains: lemon oil and conditioner, guitar polish, string cleaner and lubricant, polishing cloth, and a wood care guide.

**GCKD** .....\$26.65

### MARTIN



Made of the finest natural wax. May be used on any lacquer or varnish finish. Pump mist bottle and one 11x14 polishing cloth.

**18APKIT** .....\$14.99

#### POLISH CLOTH

**MPC** .....\$6.50

### BLITZ

#### WOOD AND LACQUER CARE

Created to lightly wax and polish fine wood.

**BL311** .....\$3.90

#### GUITAR (fretted instrument) CARE

Two cloths, safe for all wood and lacquered finishes. Polishes to a hard finish without streaking.

**BL335** .....\$6.50

#### "GLOSS CARE"

Absorbs moisture, removes fingerprints and natural oils that can mar the finish.

**BL302** .....\$4.50

### GROVER



Enhances shine and provides an anti-static finish that helps keep grime from coming back!

**GP100** w/cloth.....\$7.95

### RENEW STRING



This string cleaning system preserves that new string tone. The patented string cleaner cleans both the top and bottom of the strings, removing dirt and build-up.

**PWRSCS01** .....\$12.00

### TRICK



**TP2** Guitar polish.....\$5.75

**TP13** Micro Fiber.....7.50

### FENDER



Pump Bottle, Polish

**0504** 4 oz. ....\$8.05

**0512** 8 oz. Color Restorer.....12.50B

Restores and extends string life. Ergonomic, compact design.

**0521100** Speed Stick Cleaner ..6.99B

**0523** Fender Factory

Microfiber Cloth.....4.89

**0524** Dual-Sided Super-Soft

Microfiber Cloth.....6.85

**0525** Premium Plush Microfiber

Polishing Cloth.....9.75

Polishing cloths for guitars designed for long-lasting life. Card of 12

**0403** .....\$38.35

#### PLAIN POLISHING CLOTHS

**0404000** 12 x 15 .....\$4.25

**0400** Yellow Cloth.....3.45

**0404049** 24 Asst.....87.75

### THE SWIPE

#### Stringed Instrument Cleaning Kit

Chemical free, string and instrument cleaner. The Swipe works on ALL stringed instruments. Each pack contains a polishing cloth and our brilliant patented Swipe string and fret cleaner, all in a handy resealable foil pouch!

**SW101** .....\$7.85

### STRING CLEANER



**SCG1** Guitar .....\$13.00

**SCB1** Bass.....20.00

### GOBY



Goby Guitar Polish is formulated to lift dust, fingerprints, and other contaminants from the finish of your guitar. This water-based polish will keep new instruments looking new and vintage instruments looking great.

**GLP104** 4 oz..\$10.20

## PEAVEY®

### Guitar Polish Cloths/Cleaners



**00050780** Gray Polish Cloth...\$3.59B  
Individually Packaged

**03006630** Microfiber Cloth.....\$5.99B  
Ideal microfiber polishing cloth for most instruments. Cloth measures 16" x 16". Recommended for use with HP™ Axe Wax and HP™ Axe Wax Plus.

#### HP's Axe Wax



**03004550** HP's Axe Wax .....\$7.99B  
Leaves no unsightly residue, Nano-technology, 2 oz. spray bottle.

**03004560** HP's Axe  
Wax Plus.....\$9.99B

Dramatically reduces surface scratches while polishing finish, 2 oz. bottle with flip top.



**00457930** Guitar Polish Kit.....\$8.59B  
Kit includes 4 oz. pump spray of guitar polish and polish cloth with Peavey logo.

### ERNIE BALL



Guitar Polish. No oily film or grit. With Cloth

**EB4222** .....\$9.00B

**EB4277** Wonder Wipes.....2.10/6 pk.

### DR. STRINGFELLOW



String cleaner, conditioner.

**KDS100**.....\$5.95

Guitar polish.

**KDS500**.....5.95

Lemon oil.

**KDS800** 4 oz.....5.95

### KYSER CARE KIT

**KCPK1**.....\$24.95B

1 each 4 oz. string cleaning, lem-oil, polish and 3 opper-fiber cloths.

## STRING WINDERS

### DUNLOP



#### SCOTTY

<b>105RBK</b>	12 Black .....	<b>\$25.77</b>
<b>105RY</b>	12 Yellow .....	<b>25.77</b>
<b>105RGL</b>	12 Glow .....	<b>25.77</b>
<b>105</b>	50 Assorted .....	<b>107.06</b>
<b>G101</b>	50 Gels .....	<b>113.94</b>



<b>DUNLOP</b>		
<b>100</b>	.....	<b>\$2.50</b>



<b>ROAD PRO</b>		
<b>114</b>	Road Pro Guitar .....	<b>\$7.13</b>
<b>114J</b>	Road Pro Guitar .....	<b>154.23/24</b>
<b>115</b>	Road Pro Bass .....	<b>7.13</b>



<b>PLANET WAVES</b>		
<b>DP0002</b>	Gtr, w/cutter .....	<b>\$16.35</b>
<b>DP0002B</b>	Bass, w/cutter .....	<b>16.35</b>



<b>PLANET WAVES</b>		
<b>PWPWI</b>	Guitar .....	<b>\$10.20</b>
<b>PWPWIB</b>	Bass .....	<b>10.20</b>

## GUITAR PROFESSOR®



Your new Guitar Professor® combines three much needed guitar tools in one neat, little package: **TUNER:** With it, you can fine-tune any guitar – acoustic, electric or bass. **CHORD FINDER:** Quickly puts hundreds of chord graphs at your fingertips. **PITCH PIPE:** Offers a simple way to manually tune your guitar – especially helpful as a tuning reference for severely out-of-tune strings.

<b>QTGP1</b>	.....	<b>\$19.95</b>
--------------	-------	----------------

### PEAVEY®



Five assorted colors, contains 50 peg winders.

<b>00485250</b>	DreamerWinder™ Pegwinder Assortment Jar .....	<b>\$99.99B</b>
-----------------	---	-----------------



<b>E BALL POWER PEG/PRO</b>		
<b>EB4118</b>	.....	<b>\$30.00</b>
<b>EB4117</b>	Pro .....	<b>54.99</b>



<b>HERCO</b>		
<b>HE475</b>	Guitar .....	<b>\$5.45</b>



<b>PEGWINDERS</b>		
<b>PW25</b>	Pack of 25 .....	<b>\$28.20</b>
<b>PG042</b>	Plastic String Winder Display (colorful jar of 36) .....	<b>\$56.35</b>



<b>SHUBB</b>		
<b>SWI</b>	.....	<b>\$5.95B</b>

### PEAVEY®

#### PT100™ Tuner/Recorder



Unique chromatic guitar tuner plus recorder, backlit display, record for up to 4 minutes, requires two AAA batteries.

<b>03009010</b>	.....	<b>\$29.99B</b>
-----------------	-------	-----------------

## O PORT



The O-Port™ will make any guitar from beginner to custom sound richer, fuller, and louder, with more clarity and better projection. The O-Port material is custom blended for flexibility to prevent damage to your guitar finish and inlays. The O-Port will suppress feedback and give your acoustic or acoustic electric guitar a fuller sound with more volume, better clarity and enhanced projection.

- Richer, fuller, louder sound with more clarity and better projection
- Simple installation by loosening or removing strings and fitting O-Port into soundhole
- Suppresses feedback
- Available in Black and Ivory, in two sizes to accommodate large and small soundholes

<b>PWOPBKL</b>	Black – Large .....	<b>\$34.99</b>
<b>PWOPBKS</b>	Black – Small .....	<b>34.99</b>
<b>PWOPWHL</b>	Ivory – Large .....	<b>34.99</b>
<b>PWOPWHS</b>	Ivory – Small .....	<b>34.99</b>

## ZAP IT



Socket designed to fit any cordless screwdriver. Fast restringing of fretted instruments.

<b>GZAP</b>	.....	<b>\$6.40</b>
<b>SDOC</b>	Spin Doctor .....	<b>4.50</b>

## CHORD STAMPS



<b>JANGCBI</b>	Small .....	<b>\$7.50</b>
<b>JANGCB2</b>	Large .....	<b>7.50</b>
<b>JANGCB3</b>	Banjo/Mandolin .....	<b>7.50</b>

## FARLEYS POCKET TONES



<b>PT15</b>	C Chromatic .....	<b>\$16.99B</b>
<b>PT16</b>	F Chromatic .....	<b>16.99B</b>
<b>CHERUB</b>		
<b>S62A</b>	A440 .....	<b>\$5.95</b>

## STICK & PLAY

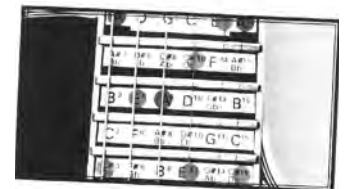

Fretboard Marking System. Contents: over 400, (4) color plastic adhering see thru overlay markers for scales, chord theory & chord progression; (1) full set of pre-cut plastic directional letter note labels (self-adhering).

<b>SP1</b>	Guitar .....	<b>\$19.95B</b>
<b>SP2</b>	Bass .....	<b>19.95B</b>
<b>SP3</b>	Banjo .....	<b>19.95B</b>
<b>SP4</b>	Mandolin .....	<b>19.95B</b>
<b>SP6</b>	Violin .....	<b>19.95B</b>



# CAPOS

## BILL RUSSELL



7193	Guitar, curved	\$5.48
7828	Banjo/Uke	4.85
7190	Guitar, flat neck	3.83
7191	12 string	5.08
7192	Doublestrap	6.18

## DUNLOP



71HT	Twelve String Guitar	\$3.95
72HT	Double Wrap 12-String Guitar	4.85
70HT	Guitar	2.10

## PICKERS PAL



PP1		\$16.07
-----	--	---------

## KYSER



KG6	Guitar	\$24.95B
Available In: Black (BK), Blue (B), Red (R), Gold (GO), Silver (SI), White (W), Pink (K), Black Chrome (BC), Purple (P), Copper Vein (CV) & Silver Vein (SV), Emerald Green (G), Lavender (L), Orange (O), Yellow (Y), Red Bandana (RB), Freedom (F), Camo (C)		

KGC	Classical, Black, Gold	24.95B
KG12	12 String, Black	24.95B
KBM	Banjo/Mandolin, Black	24.95B
KGBEK	Electric, Black	24.95B
KGBDK	Drop Capo	24.95B
KG3	Short Cut Capo BK, GO, SI	24.95B
KBBT	Banjo Boot	.75
KGBT	Guitar Boot	.75
KPA	Pro Am Guitar	7.95B
KPAC	Pro Am, Classical	7.95B

## PAIGE



KP6E	Guitar, Ebony	\$24.95
KP6EZ	Guitar, Electric	24.95
KP12E	12-String, Black	24.95
KPBE	Banjo/Mandolin, Black	24.95
KPCB41437R	Radius Mandolin	29.95
KPBNW	Banjo, Wide	24.95
KPCB51812R	Radius Banjo	29.95
KPC62062R	Click Guitar, 2 <sup>1</sup> / <sub>16</sub>	29.95
KPC62250R	Click Guitar, 2 <sup>1</sup> / <sub>4</sub>	29.95
KPCB41437R	Banjo to 4th	29.95
KPCB51812R	Banjo Past 4th	29.95
PSCR	Spring Capo	8.95

### Paige Capos Replacement Sleeves

PRS6	Fits all 6-String Guitar models	\$1.50
PRS12	Fits 12-String and 6-String wide profile Guitar models	1.50
PRSB	Fits Banjo/Mandolin models	1.50
PRSBW	Fits Banjo/Mandolin models wide	1.50
PRS6EZ	Fits 6-String Electric Guitar	3.00
PRSL6	Fits Classical Guitar	1.50

## K LEVER

KLDB	Double Drop D	\$45.00B
KLDD	Drop D	45.00B
KLOG	Open G	45.00B
KLSC	Short Cut	45.00B



## BIRD OF PARADISE

BIRD		\$19.95B
BIRDBK	Black	21.00



## DUNLOP



Deluxe Professional Capo (curved,	
15CD	\$10.84
Deluxe Professional Capo (flat)	
15FD	\$10.84

### Professional Model

14CD	Curved Fretboard	\$9.67
14FD	Flat Fretboard	9.67

### Advanced Model

11CD	Curved Fretboard	\$7.72
11FD	Flat Fretboard	7.72

### Elastic

70FD	Guitar	\$3.16
71SD	12 String	4.37
72DD	12 String, double strap	5.63
741	Capo/Slide Converter	35.69

## TRIGGER



83C	Guitar, Curved	\$23.39
84F	Guitar, Flat	23.39
84FM	Flat, Maple	29.25
84FS	Flat, Smoked Chrome	23.39
85BB	Banjo, Flat, Black	23.39
86MB	Mandolin, Black	23.39
87	Electric, N, B	23.99
88	Classical, N, BK	23.99
83CS	Curved, Smoked Chrome	23.99
83CM	Curved, Maple	29.25
JCS50C	Curved, Johnny Cash	38.62B
JCS50F	Flat, Johnny Cash	38.62B
Available In: Black (B), Nickel (N), Gold (G)		

## SEAVEY GUITAR CAPO

### SIX STRING

03012280	Anodized Finish	\$13.99B
03017780	Black Finish	15.99

## FENDER SMART CAPO



FSCST	Guitar	\$34.95
FSCCL	Classical	34.95
FSCFS	Finger Style / 12 String	34.95

## VICTOR



DCV50C	Guitar, Curved	\$30.97B
DCV50F	Guitar, Flat	30.97B

## FEEL NO FRET

HF6C	Guitar Acoustic/Electric	\$9.45
------	--------------------------	--------

## ON/STAGE CAPOS

GA100	Black, Guitar	\$23.99
GA200	Silver, Ukulele	22.99
GA300	Black, Classical Guitar	23.99

## PLANET WAVES



PWCP01	Ratchet	\$15.30
PWCP02	NS 6/12 String Guitar Bk	29.55
PWCP04	NS Classical	27.55
PWCP06	NS Trio	27.55
PWCP07	NS Lite Acou/Ele	15.30
PWCP09	NS Tri-Action Acou/Ele	32.65
PWCP10	NS 6 String Acou/Ele	32.65
PWCP11	NS Banjo/Mandolin	27.55
PWCP12	NS Ukulele	27.55

## HAMILTON

KB19A	Fast Action, Guitar	\$7.99
KB19	Guitar	8.00

## GROVER

GP750	Ultra Capo	\$19.95
Black (BL), Red (RD), Silver (SL)		

## SHUBB



SC1N	C1 Brushed Nickel Guitar Capo	\$26.95B
SC2N	C2 Brushed Nickel Nylon Capo	26.95B
SC3N	C3 Brushed Nickel 12 String Guitar Capo	26.95B
SC4N	C4 Brushed Nickel Electric Guitar Capo	26.95B
SC5N	C5 Brushed Nickel Banjo Capo	26.95B
SC1	Guitar, Nickel	24.95B
SC2	Nylon, Nickel	24.95B
SC3	12 String, Nickel	24.95B
SC4	Electric, Nickel	24.95B
SC5	Banjo, Nickel	24.95B
SC9B	Uke Brass	24.95B
SC1K	Thur SC5K Black Chrome	29.95B

### Also Available in:

(B) Brass, (K) Black, (A) Antique

SC7B	Partial, Brass	26.95B
SC6B	Dobro, Brass	46.95B
SCS1	Sleeves	1.00B
SRTC	Rubber, Tip Cover	1.00B
SSI	Guitar, Deluxe	29.95B
SS2D	Classic, Deluxe	29.95B
SS3D	12 String, Deluxe	29.95B
SS5D	Banjo, Deluxe	29.95B
SL1	Guitar, Aluminum	26.95B
SL2	Nylon, Aluminum	26.95B
SL3	12 String, Aluminum	26.95B
SL4	Electric	26.95B
SL5	Banjo	26.95B
SL9	Uke, Aluminum	26.95B
SC8B	Drop D	26.95B
SS5R	Banjo, Curved Radius	29.95B
STG1	Trans/Capo Guide	9.95B

SL1, SL2, SL3, SL4, SL5 & SL9 also available in:  
(B) Blue, (G) Green, (R) Red,  
(V) Violet, (GO) Gold

## 5TH STRING



SFS	Shubb	\$46.95B
SFSG	Shubb Gold	90.00B
OSSCN5	Shubb Old Style, Long Bar	46.95B

## SPIDER



C1	6 & 12 String	\$39.99
SCM	Banjo, Uke, Mandolin	39.99
SCX	Classic, 6 String Bass	44.99
HGL1	Harmonik Gloves	12.99

## G7TH

G7NP12	Newport 12 String Pressure Touch	\$39.99
G7NPCC	Newport Classical Pressure Touch	39.99
G7NPP3	Newport Partial #3 Pressure Touch	39.99
G7NPP5	Newport Partial #5 Pressure Touch	39.99
G7TH	Guitar (Performance 2)	59.95
G7BK	(Performance 2)	59.95
G7CC	Classic (Performance 2)	59.95
G712	12 String	59.95
G7NPUB	Newport Uke/Banjo	39.99
G7NPBK		39.99
G7NPSI	Newport	39.99
G7NC	Nashville Classic	29.99
G7NSI	Nashville	29.99
G7NBK	Nashville, Black	29.99

# SLIDES/STEELS

## BOTTLENECK SLIDES



**STEEL**

JANS	2" Blue Label, Acoustic.....	<b>\$6.75</b>
JANL	2 1/2" Green Label, Wide Neck.....	<b>6.75</b>
JANJ	2" Brown Label, Jumbo.....	<b>6.75</b>
JANES	Red Label, Electric.....	<b>6.00</b>

**GLASS:**

JANGL	Light.....	<b>\$8.40</b>
JANGM	Medium.....	<b>8.40</b>

**ASSORTMENT:**

JANBA1	12 Asst. Steel.....	<b>\$83.25c/d</b>
JANBA2	12 Asst. Steel & Glass.....	<b>86.55c/d</b>

## CORRICIADAN



**CLASSIC**

RBN1	Small *.....	<b>\$9.95B</b>
RBN2	Medium *.....	<b>9.95B</b>
RBN3	Large *.....	<b>9.95B</b>
RBN4	Small, Heavy wall.....	<b>13.50B</b>
RBN5	Medium, Heavy wall.....	<b>13.50B</b>
RBN6	Large, Heavy wall.....	<b>13.50B</b>
RBN7	Medium, Flared *.....	<b>10.95B</b>
RBN8	Large, Flared *.....	<b>10.95B</b>

\*Available in Red, Yellow, Green & Blue.....**\$17.50B**

## DUNLOP GLASS SLIDES



202	Regular Wall, Medium R/S 8.....	<b>\$6.34</b>
203	Regular Wall, Large R/S 12-13.....	<b>6.34</b>
204	Knuckle, Short R/S 10-11.....	<b>6.34</b>
210	Medium Wall, Medium R/S 10-11.....	<b>8.20</b>
211	Heavy Wall, Small R/S 6-7.....	<b>9.39</b>
212	Heavy Wall, 2 inch R/S 6-7.....	<b>8.20</b>
213	Heavy Wall, Large R/S 13.....	<b>9.20</b>
215	Heavy Wall, Medium R/S 10-11.....	<b>9.39</b>
218	Heavy Wall, Short/Medium R/S 10-11.....	<b>9.39</b>
DUN234	Pyrex Flare, Medium R/S 10-11.....	<b>10.57</b>
DUN235	Pyrex Flare, Large R/S 13.....	<b>11.96</b>

## MOONSHINE GLASS

C213	Heavy Wall Large, R/S 13.....	<b>\$20.89</b>
C215	Heavy Wall Medium, R/S 10 1/4.....	<b>20.89</b>

Note: R/S = Ring Size

## SLIDE DISPLAY



Each SR-20 slide display rack includes a plastic protection lid and the following Jim Dunlop Top Selling Slides: **Glass** 2-202, 2-203, 2-210, 2-212, 2-213, 2-215, 1-218; **Chromed Steel**: 2-220; **Brass**: 2-222; **Brass Chrome**: 1-228; **Blues Bottle**: 1-275, & 1-276.

DUNSR20	.....	<b>\$200.43</b>
SR20E	Display Only.....	<b>49.65</b>

[www.jimdunlop.com](http://www.jimdunlop.com)

## DUNLOP STEELS/SLIDES



**STEELS**

918	3/4" O.D. Stainless Steel, 5.5 oz.....	<b>\$29.93B</b>
919	3/4" O.D. Stainless Steel, 4.5 oz.....	<b>29.93B</b>
920	7/8" O.D. Stainless Steel, 7.2 oz.....	<b>37.40B</b>
921	1" O.D. Stainless Steel, 11.5 oz.....	<b>37.40B</b>



345	Stevens Steel.....	<b>\$20.90</b>
911	911 Mudslide Classic Tonebar.....	<b>44.99</b>
912	911 Mudslide Hybrid Tonebar.....	<b>47.65</b>
925	Ergo Tone Bar.....	<b>44.99B</b>
926	Lap Dawg Tone Bar.....	<b>44.99B</b>
927	Long Dawg.....	<b>47.65B</b>
928	Ben Harper Tone Bar.....	<b>50.95B</b>

## ERNIE BALL



EB4234	Pinky Slider.....	<b>\$8.00</b>
EB4235	Ring Slider.....	<b>10.50</b>
EB4233	Heavy Steel Bar.....	<b>22.50B</b>

## ROBERT RANDOLPH



SRR1	6.25 oz. Steel.....	<b>\$32.95B</b>
SRR2	7.5 oz. Steel.....	<b>32.95B</b>

## SHUBB/PEARSE



SSP1	Lap Steel.....	<b>\$34.95B</b>
------	----------------	-----------------



SSP2	Dobro, Lap Steel.....	<b>\$34.95B</b>
------	-----------------------	-----------------



SSP3	Bluegrass.....	<b>\$34.95B</b>
------	----------------	-----------------



SGS1	Wood/Stainless.....	<b>46.95B</b>
------	---------------------	---------------

## MOONSHINE CERAMIC



243	Medium R/S 6 1/2-7.....	<b>\$21.30B</b>
246	Large R/S 7 1/2-9.....	<b>21.30B</b>

Note: R/S = Ring Size

## MUDSLIDE PORCELAIN



263	Medium R/S 6 1/2-7.....	<b>\$21.21B</b>
266	Large R/S 7 1/2-9.....	<b>21.21B</b>

Note: R/S = Ring Size

## BLUES BOTTLE



271	Traditional Wall Small R/S 9-9 1/2.....	<b>\$13.53B</b>
272	Traditional Wall Med R/S 10-10 1/2.....	<b>13.53B</b>
273	Traditional Wall Large R/S 12-12 1/2.....	<b>13.53B</b>
274	Heavy Wall Small R/S 9-9 1/2.....	<b>17.48B</b>
275	Heavy Wall Medium R/S 10-10 1/2.....	<b>17.48B</b>
276	Heavy Wall Large R/S 12-12 1/2.....	<b>17.48B</b>
277	Traditional Wall Med* R/S 10-10 1/2.....	<b>21.10</b>
278	Traditional Wall Large* R/S 12-12 1/2.....	<b>21.10</b>

\*Available in (B) Blue, (R) Red, (Y) Yellow, (SB) Sunburst

Note: R/S = Ring Size

## HARRIS BRASS



DUN231	Medium R/S 9 1/4.....	<b>\$23.11</b>
DUN232	Large R/S 11.....	<b>23.11</b>

Note: R/S = Ring Size

## JOE PERRY



**BONEYARD MUDSLIDE**

255	Long R/S 8.....	<b>\$28.49B</b>
256	Short R/S 5-6.....	<b>28.49B</b>
257	Long, Large R/S 9-10.....	<b>28.49B</b>
258	Short, Large R/S 9-10.....	<b>28.49B</b>

Note: R/S = Ring Size

## DEREK TRUCKS SIGNATURE SLIDE

DT01	R/S 12-12 1/2.....	<b>\$20.89</b>
------	--------------------	----------------

## KEB MO



**MUDSLIDE**

265	R/S 10-11.....	<b>\$28.49B</b>
-----	----------------	-----------------

[www.jimdunlop.com](http://www.jimdunlop.com)

## LATCH LAKE SLIDES

### CHROME DOME



Unique dome end chrome plated brass slide.

<b>CDS</b> Small .....	<b>\$28.35</b>
<b>CDM</b> Medium .....	<b>28.35</b>
<b>CDL</b> Large .....	<b>28.35</b>

### ACOUSTA GLIDE



Tapered heavyweight slide.

<b>AGS</b> Small .....	<b>\$26.25</b>
<b>AGM</b> Medium .....	<b>26.25</b>
<b>AGL</b> Large .....	<b>26.25</b>
<b>AGXL</b> Xtra Large .....	<b>26.25</b>

### DELTA CLASSIC



Medicine bottle glass slide.

<b>DCSTA</b> Standard .....	<b>\$12.60</b>
<b>DCSTU</b> Stubby .....	<b>12.60</b>

## CLAYTON



### GLASS SLIDES

<b>CSW10</b> Large, Standard Wall .....	<b>\$5.98</b>
<b>CSW11</b> Medium, Standard Wall .....	<b>5.98</b>
<b>CSW12</b> Small, Standard Wall .....	<b>5.98</b>
<b>CHW10</b> Large, Heavy Wall .....	<b>8.50</b>
<b>CHW11</b> Medium, Heavy Wall .....	<b>8.50</b>
<b>CHW12</b> Small, Heavy Wall .....	<b>8.50</b>
<b>CSWA</b> 12 Assorted S't'd Wall .....	<b>71.75</b>

### SLIDE RITE



Tapered shape optimized for electric guitar.

<b>SRS</b> Small .....	<b>\$19.55</b>
<b>SRM</b> Medium .....	<b>19.55</b>
<b>SRL</b> Large .....	<b>19.55</b>

Correct design for lap steel guitar.

<b>BOP</b> Broz O Phonic .....	<b>\$28.35</b>
--------------------------------	----------------

### BRASS SLIDE



Hand buffed brass slide.

<b>LLBSS</b> Small .....	<b>\$10.50</b>
<b>LLBSM</b> Medium .....	<b>10.50</b>
<b>LLBSL</b> Large .....	<b>10.50</b>

### MUSIC BENDERS



### Illuminating Glass Guitar Slides

<b>ISFMR</b> Red Hot Illuminating Glass .....	<b>\$24.99*</b>
<b>ISFMB</b> Electric Blue Illuminating Glass .....	<b>24.99*</b>
<b>ISFMF</b> The Flash Illuminating Glass .....	<b>26.99*</b>

### PEACELAND GUITAR RINGS



#### Brass

<b>B2065KR</b> 0.75" Ring, Size 6.5 .....	<b>\$15.00</b>
<b>B2090KR</b> 0.75" Ring, Size 9 .....	<b>15.00</b>
<b>B2130KR</b> 0.75" Ring, Size 13 .....	<b>15.00</b>
<b>B3065KR</b> 1.0" Ring, Size 6.5 .....	<b>15.00</b>
<b>B3090KR</b> 1.0" Ring, Size 9 .....	<b>15.00</b>
<b>B3130KR</b> 1.0" Ring, Size 13 .....	<b>15.00</b>

#### Stainless

<b>S2060KR</b> 0.75" Ring, Size 6 .....	<b>16.50</b>
<b>S2110KR</b> 0.75" Ring, Size 11 .....	<b>16.50</b>
<b>S3060KR</b> 1.0" Ring, Size 6 .....	<b>16.50</b>
<b>S3110KR</b> 1.0" Ring, Size 11 .....	<b>16.50</b>

#### Glass Brass

<b>GB3090KR</b> 1" Ring, Size 9 .....	<b>24.95B</b>
---------------------------------------	---------------

## DUNLOP STEEL SLIDES



### STEEL SLIDES

<b>220</b> Chrome, Med. Wall R/S 9-10 .....	<b>\$7.52</b>
<b>221</b> Chrome, Knuckle R/S 9-10 .....	<b>7.53</b>
<b>222</b> Brass, Med. Wall R/S 9-10 .....	<b>8.91</b>
<b>223</b> Brass, Knuckle R/S 9-10 .....	<b>8.55</b>
<b>224</b> Brass, Heavy Wall R/S 12-13 .....	<b>16.56</b>
<b>225</b> Sml Stainless R/S 9 .....	<b>36.08B</b>
<b>226</b> Lge Stainless R/S 1 1/2 .....	<b>36.08B</b>
<b>228</b> Brass, Chrome Plated R/S 9-10 .....	<b>20.15</b>
<b>229</b> Shy Slide .....	<b>8.36</b>
<b>318</b> Chrome, X Lge., R/S 12-13 Short .....	<b>12.81</b>
<b>320</b> Chrome, X Lge., R/S 12-13 Long .....	<b>13.44</b>
<b>741</b> Capo/Slide Converter .....	<b>35.69</b>

Note: R/S = Ring Size



### BRASS SLIDES

<b>227</b> Concave, Medium, R/S 9-10 .....	<b>\$21.15</b>
<b>284</b> Preachin Pipe, Med, R/S 7-8 .....	<b>25.13B</b>
<b>285</b> Preachin Pipe, Lge, R/S 8-9 .....	<b>25.13B</b>
<b>286</b> J. Winter Texas Slider, R/S 6-7 .....	<b>16.41B</b>

Note: R/S = Ring Size

## DANDREA



<b>D200</b> Glass, Medium .....	<b>\$7.35</b>
<b>D300</b> Steel, Medium .....	<b>11.50</b>
<b>D202</b> 2/Glass, Reg. + Knuckle .....	<b>14.65</b>
<b>D302</b> 2/Steel, Reg. + Knuckle .....	<b>17.75</b>
<b>D550</b> Medicine Bottle .....	<b>14.30</b>

## PLANET WAVES



<b>GLASS</b>	
<b>PWGSSS</b> Small .....	<b>\$10.00</b>
<b>PWGSSM</b> Medium .....	<b>10.00</b>
<b>PWGSSL</b> Large .....	<b>10.00</b>



<b>CHROME/BRASS</b>	
<b>PWCBSSS</b> Small .....	<b>\$14.30</b>
<b>PWCBSSM</b> Medium .....	<b>18.35</b>
<b>PWCBSSL</b> Large .....	<b>18.35</b>



<b>D STYLE GLASS</b>	
<b>PWGDSSS</b> Small .....	<b>\$18.35</b>
<b>PWGDSSM</b> Medium .....	<b>18.35</b>
<b>PWGDSSL</b> Large .....	<b>18.35</b>

## PEAVEY® SLIDES



Medium size glass and steel slides

<b>00475710</b> Glass Slide .....	<b>\$6.39B</b>
<b>00475720</b> Steel Slide .....	<b>6.79B</b>

## REV WILLY



<b>RWS11</b> Red Mo-Jo Medium R/S 10-11 .....	<b>\$20.50B</b>
<b>RWS12</b> Mo-Jo Cer Large R/S 10-11 .....	<b>26.61B</b>
<b>RWS13</b> Mo-Jo Cer Extra Large R/S 12-13 .....	<b>26.61B</b>

Note: R/S = Ring Size

## SHUBB AXYS



### ROTABLE

<b>AX</b> Includes: SM, MD, LG inserts .....	<b>\$29.95B</b>
--	-----------------

## NUTS



### Shaped and Fitted (Plastic)

<b>3301</b>	2" wide .....	<b>\$1.00</b>
<b>3302</b>	1 7/8" wide .....	<b>1.00</b>
<b>3303</b>	1 3/4" wide .....	<b>1.00</b>
<b>3304</b>	1 1/2" wide .....	<b>1.00</b>
<b>3306</b>	12 string guitar .....	<b>1.25</b>



### BONE NUTS

<b>3338</b>	Synthetic Bone .....	<b>\$4.05</b>
<b>HSPBN25</b>	Synthetic Acoustic .....	<b>4.00</b>
<b>21100</b>	Steel String .....	<b>8.45</b>
<b>21112</b>	Classical .....	<b>10.90</b>
<b>M502</b>	Banjo/Mandolin .....	<b>5.00</b>
<b>HSPGSN25</b>	Graphite Strat .....	<b>4.50</b>
<b>HSPGN25</b>	Accous.Graphite .....	<b>4.99</b>
<b>801100</b>	Delrin, for Gibson .....	<b>13.35</b>
<b>801200</b>	Delrin, for Fender .....	<b>13.35</b>
<b>HSPBSN25</b>	Synthetic Strat.....	<b>3.00</b>

### EXTENSION NUT



<b>SM4596</b>	(Stew-Mac) .....	<b>\$8.35</b>
<b>SF3303</b>	(Saga) .....	<b>8.95</b>

## WD NUTS / SADDLES



WD900FW

### SHAPED AND FITTED (Plastic)

<b>WD900FW</b>	Folk Nut .....	<b>\$3.00</b>
<b>WD90012</b>	12 String Nut.....	<b>3.00</b>
<b>WD900B</b>	Bass Nut .....	<b>3.00</b>
<b>WD900BJ</b>	Banjo Nut.....	<b>3.00</b>
<b>WD900C</b>	Classic Nut.....	<b>3.00</b>
<b>WD900E</b>	Electric Nut.....	<b>3.00</b>
<b>WD900M</b>	Mandolin Nut .....	<b>3.00</b>



WD900ST

<b>WD900ST</b>	Strat Nut.....	<b>\$3.00</b>
<b>BNG</b>	Bone Nut, Guitar .....	<b>8.50</b>
<b>BJN30</b>	Banjo Bone Nut .....	<b>8.10</b>
<b>BNFF</b>	Fender Nut, Flat .....	<b>6.00</b>
<b>NTCS</b>	Graphite Nut Slotted.....	<b>7.00</b>
<b>PSCL</b>	Classic Saddle Plastic .....	<b>2.00</b>
<b>PSF</b>	Acoustic Saddle Plastic .....	<b>2.00</b>



EZGTMAJ



EZGTDB



EZGTBB

## EZ GUITAR TRAINER

The perfect learning aid for beginners and aspiring musicians. Vibrant color-coded system helps new players more effectively learn to play guitar. Unique clear cling strips easily wrap around any guitar neck without adhesive or damage.

Set of major chords for your customer that wants to quickly learn how to play songs. Foundation for thousands of songs that can be played.

<b>EZGTMAJ</b>	EZ Guitar Major Chrd .....	<b>\$9.99 set</b>
----------------	----------------------------	-------------------

Additional and complimentary chords for customers to learn and play thousands of more songs.

<b>EZGTMIN</b>	EZ Guitar Minor Chrd.....	<b>\$9.99 set</b>
----------------	---------------------------	-------------------

Set to traditionally identify and decipher each individual note on fret board.

<b>EZGTN</b>	EZ Guitar Notes .....	<b>\$9.99 set</b>
--------------	-----------------------	-------------------

Combination package of Major, Minor and Notes.

<b>EZGTBB</b>	EZ Guitar Basic Bundle .....	<b>\$24.99 set</b>
---------------	------------------------------	--------------------

A complete Point of Sale tool with an attractive display stand and an assortment of each product set. Out of box offering you can strategically place within store to increase exposure and impulse purchases. Includes 4 sets of Majors, Minors, Notes and Basic Bundle sets.

<b>EZGTDB</b>	EZ Guitar Display Bundle .....	<b>\$179.00</b>
---------------	--------------------------------	-----------------

## BRIDGE SADDLES



<b>3340</b>	White, Steel String .....	<b>\$ 1.25</b>
<b>3341</b>	White, Classical .....	<b>1.25</b>
<b>21183</b>	Bone Classical .....	<b>8.25</b>
<b>21122</b>	Bone Steel String .....	<b>6.30</b>
<b>SF3401</b>	Bone, Long.....	<b>4.40</b>
<b>SF3405</b>	Bone, 1/8" .....	<b>4.40</b>
<b>MM2400</b>	Compensated.....	<b>19.95/5</b>
<b>HSPBS25</b>	Bone.....	<b>2.70</b>
<b>HSPGS25</b>	Graphite .....	<b>2.99</b>

## NUT SAUCE



Nut Sauce is a tuning lubricant.

<b>LLU</b>	0.5CC Little Luber .....	<b>\$12.45</b>
<b>GL</b>	1.5CC Groove Luber.....	<b>24.95</b>
<b>BBSS</b>	String Sleeves .....	<b>5.00</b>
<b>BBBL</b>	Bench Luber .....	<b>59.95</b>
<b>BBESR</b>	Scratch Remover .....	<b>12.45</b>

## LUBRI KIT



Provides tuning stability, combats string breakage, Ends premature wear at bridge and nut.

<b>PWLBK01</b>	.....	<b>\$18.00</b>
----------------	-------	----------------

## PARTS ASSORTMENTS



### Fingerboard Nut Assortment

Includes 10 dozen top nuts for guitar, banjo, mandolin and bass.

<b>GP170</b>	120 pieces.....	<b>\$109.50</b>
<b>MM2500</b>	50 pieces .....	<b>44.95</b>

### Bridge Saddle Assortment

<b>GP173</b>	144 pieces .....	<b>\$108.00</b>
--------------	------------------	-----------------



Grover high-quality assortment. 240 of the most commonly used bridge pins, end pins, nuts and saddles.

<b>GP175</b>	.....	<b>\$186.95</b>
--------------	-------	-----------------

PRICES SUBJECT TO CHANGE WITHOUT NOTICE

# MIGHTY MITE PARTS



MM1302/1304



MM5604C



MM909C



MM913AM



MM2300



MM5600



MM908



MM91418

## HARDWARE

<b>MM1302</b>	Tremolo Arm, Strat style, with White knob .....	<b>6.95</b>
<b>MM1304</b>	Tremolo Arm, Strat style, with Black knob .....	<b>6.95</b>
<b>MM1506C</b>	String Retainer Bar – Chrome .....	<b>4.95</b>
<b>MM1506BK</b>	String Retainer Bar – Black .....	<b>5.95</b>
<b>MM1506GO</b>	String Retainer Bar – Gold .....	<b>5.95</b>
<b>MM1508B</b>	Black String Tree (2 pk) Roller Type.....	<b>5.95 pk.</b>
<b>MM1508C</b>	Chrome String Tree (2 pk) Roller Type .....	<b>4.95 pk.</b>
<b>MM2300</b>	7 Bridge Pins, White with Black Dot and 1 White End Pin.....	<b>6.95</b>
<b>MM2302</b>	7 Bridge Pins, Black with White Dot and 1 Black End Pin .....	<b>6.95</b>
<b>MM2304</b>	7 Bridge Pins, Cream with White Dot and 1 Black End Pin.....	<b>6.95</b>
<b>MM5610BK</b>	Strap Buttons, Set of 2 with Screws – Black .....	<b>4.95</b>
<b>MM5610C</b>	Strap Buttons, Set of 2 with Screws – Chrome.....	<b>4.50</b>
<b>MM5610GO</b>	Strap Buttons, Set of 2 with Screws – Gold.....	<b>4.95</b>
<b>MM5612C</b>	Strap Buttons (2) Oversize, Chrome.....	<b>4.50</b>
<b>MM5612GO</b>	Strap Buttons (2) Oversize, Gold.....	<b>5.50</b>
<b>MM5612BK</b>	Strap Buttons (2) Oversize, Black .....	<b>5.50</b>
<b>MM5604BK</b>	Neck Plate – Black .....	<b>8.95</b>
<b>MM5604C</b>	Neck Plate – Chrome .....	<b>7.95</b>
<b>MM5604GO</b>	Neck Plate – Gold .....	<b>12.95</b>
<b>MM5600</b>	Black Strat Style Recessed Jack Plate.....	<b>6.95</b>
<b>MM5601</b>	Chrome Strat Style Recessed Jack Plate .....	<b>6.95</b>
<b>MM5602</b>	Gold Strat Style Recessed Jack Plate .....	<b>6.95</b>
<b>MM5608C</b>	TeleControl Plate, Chrome.....	<b>5.95</b>
<b>MM5608GO</b>	TeleControl Plate, Gold.....	<b>10.95</b>

<b>MM309C</b>	Mounting Ring w/hardware, Chrome.....	<b>\$11.95</b>
<b>MM309BK</b>	Mounting Ring w/hardware, Black.....	<b>13.95</b>
<b>MM309GO</b>	Mounting Ring w/hardware, Gold.....	<b>13.95</b>
<b>MMHS001C</b>	Bass String Trees, Chrome (2) .....	<b>7.50</b>
<b>MM500</b>	3 Position Toggle Switch with Black Knob (Box Style).....	<b>7.95</b>
<b>MM503</b>	5 way Select Switch with Black Knob .....	<b>9.95</b>
<b>MM504</b>	Knobs for 5-way Switch – Black (pkg. of 3) .....	<b>5.95</b>
<b>MM506</b>	Knobs for 5-way Switch – White (pkg. of 3).....	<b>5.95</b>
<b>MM518</b>	Mini Toggle On/On.....	<b>7.95</b>
<b>MM700</b>	A250K Control Pot-dime size .....	<b>5.00</b>
<b>MM702</b>	D500K Control Pot-dime size .....	<b>5.00</b>
<b>MM112</b>	End Pin Jack – Chrome .....	<b>8.95</b>
<b>MM111</b>	Flush Mount Jack.....	<b>9.95</b>
<b>MM902</b>	Black Speed Knobs (2 per pack).....	<b>6.95</b>
<b>MM900</b>	White Speed Knobs (2 per pack).....	<b>6.95</b>
<b>MM904</b>	Gold Speed Knobs (2 per pack).....	<b>6.95</b>
<b>MM906</b>	Metal Dome Control Knob – Black (2 per pack).....	<b>9.95</b>
<b>MM907</b>	Metal Dome Control Knob – Gold (2 per pack).....	<b>10.50</b>
<b>MM908</b>	Metal Dome Control Knob – Chrome (2 per pack) .....	<b>9.95</b>
<b>MM909BK</b>	Metal Dome Control Knob – Black (2 per pack) .....	<b>9.95</b>
<b>MM909C</b>	Metal Dome Control Knob – Chrome (2 per pack) .....	<b>9.95</b>
<b>MM909GO</b>	Metal Dome Control Knob – Gold (2 per pack).....	<b>11.50</b>
<b>MM913CR</b>	Cream Bell Knob (4 per pack).....	<b>11.95</b>
<b>MM913AM</b>	Amber Bell Knob (4 per pack) .....	<b>11.95</b>
<b>MM910912</b>	Retro Style Knobs, White,w/Gold Cap,Gold #,1Vol. 2Tone.....	<b>5.95</b>
<b>MM914918</b>	Control Knob, Strat Style – Black1Vol, 2 Tone.....	<b>5.95</b>
<b>MM916920</b>	Control Knob, Strat Style – White1Vol, 2 Tone.....	<b>5.95</b>



## NECKS

All Fingerboards are Fretted, Sanded and Sealed

<b>MM2900</b>	Strat Neck w/Rosewood Fgbd.....	<b>\$155.00</b>
<b>MM2900L</b>	Strat Neck w/Rosewood Fgbd (Lefty) .....	<b>155.00</b>
<b>MM2902</b>	Strat Neck, w/Maple Fgbd.....	<b>150.00</b>
<b>MM2928</b>	Stratneck w/Maple Fgbd. <b>Jumbo Frets</b> .....	<b>150.00</b>
<b>MM2934VT</b>	V/Tint Strat Neck w/Rosewood Fgbd.....	<b>189.00</b>
<b>MM2935VT</b>	V/Tint Strat Neck w/Maple Fgbd.....	<b>189.00</b>
<b>MM2904</b>	Tele Neck, w/Rosewood Fgbd. ....	<b>155.00</b>
<b>MM2904VT</b>	w/Tint Tele Neck R/Wood Fgbd.....	<b>189.95</b>
<b>MM2905</b>	Tele Neck, Maple .....	<b>150.00</b>
<b>MM2905V</b>	Vint Tele Neck, Maple w/Maple Fgbd.....	<b>150.00</b>
<b>MM2906</b>	P-Bass, Style, w/Rosewood Fgbd. ....	<b>154.00</b>
<b>MM2907</b>	P-Bass Style, One Piece Maple Neck .....	<b>159.00</b>
<b>MM2908</b>	J-Bass Style, Rosewood Fingerboard.....	<b>155.00</b>
<b>MM2920</b>	P-Bass Style, 5 String w/Rosewood Fingerboard .....	<b>160.00</b>

STRAT and P.J. BASS are trademarks of Fender Musicarument Co., which is not affiliated with MIGHTY MITE Parts. LP is a trademark of Gibson Musical Instrument Co., which is not affiliated with MIGHTY MITE Parts. Floye Rose is not affiliated with MIGHTY MITE Parts.

[www.mightymite.com](http://www.mightymite.com)



## BODIES

<b>MM2705FR</b>	Red Tele Body .....	<b>\$230.00</b>
<b>MM2700FBS</b>	Blue SB Strat Body.....	<b>230.00</b>
<b>MM2700FCS</b>	CHE SB Strat Body.....	<b>230.00</b>
<b>MM2702FBS</b>	Blue SB P-Bass Body .....	<b>230.00</b>
<b>MM2705FI</b>	Aged White Tele Body.....	<b>230.00</b>
<b>MM2705FBK</b>	Black Tele Body .....	<b>230.00</b>
<b>MM2705FBS</b>	Blue S/B Tele Body .....	<b>230.00</b>
<b>MM5700</b>	Blk/Wht/Blk P Bass Pick Guard.....	<b>17.95</b>

## STRAT KITS

Contains: Back Plate, P/U Covers, Trem Arm Knob, VT Knobs and Switch Tip. Available in **(B) Black, (W) White, (AW) Antique White, (MG) Mint Green.**

<b>MM5912</b>	Specify color .....	<b>\$19.95</b>
---------------	---------------------	----------------

## The world's largest manufacturer of branded nuts, saddles and bridge pins

### I. E. (Tuning Forks, Pitch Pipes, Humidifiers, Polish and Cloths)

**CHOPS**®

Professional Hand Care For Musicians

Before You Play

**PREPLAY**™



PH-0001-00: 30ml bottle  
MSRP \$19.95

(Available in 6, 24 and 48-packs)  
Approx 200 applications/bottle

**Warning: Your hands are destroying your guitar.**

Chops PrePlay balances your skin's pH level and protects your guitar, hardware and strings from damage caused by oily and/or acidic hands. PrePlay is made with natural ingredients and oil extracts, is hypoallergenic and absorbs in seconds without any greasy feel. PrePlay noticeably improves feel, slide and glide leaving your hands with a fresh, clean citrus smell and a light smooth finish.

### I.H. (Picks)

**TUSQ**®  
MAN-MADE IVORY PICKS



**Picks with built in tone**

The type of pick you use affects the tone you create. We formulated our proprietary TUSQ material and created a whole new class of picks with highly resonant characteristics that produce three distinctive tones: **Bright, Warm and Deep**. TUSQ picks also have a high stiffness to thickness ratio, like real tortoise shell but with a harmonic content only TUSQ can deliver. Experience a smooth, balanced feel and a clean articulate attack.

Model #	Thickness	Color	Pack	MSRP
<b>Bright tone / Standard Shape:</b>				
PQP-0100-W6	1 mm	White	6	\$5.95
PQP-0088-W6	.88 mm	White	6	\$5.95
PQP-0068-W6	.68 mm	White	6	\$5.95
PQP-0100-W72	1 mm	White	72	\$56.95
PQP-0088-W72	.88 mm	White	72	\$56.95
PQP-0068-W72	.68 mm	White	72	\$56.95
<b>Bright tone / Bi Angle shape:</b>				
PQP-0402-W4	2 mm	White	4	\$5.95
PQP-0401-W4	1 mm	White	4	\$5.95
PQP-0488-W4	.88 mm	White	4	\$5.95
PQP-0402-W48	2 mm	White	48	\$56.95
PQP-0401-W48	1 mm	White	48	\$56.95
PQP-0488-W48	.88 mm	White	48	\$56.95
<b>Bright tone / Tear Drop shape:</b>				
PQP-0514-W6	1.4 mm	White	6	\$5.95
PQP-0501-W6	1mm	White	6	\$5.95
PQP-0588-W6	.88 mm	White	6	\$5.95
PQP-0514-W72	1.4 mm	White	72	\$56.95
PQP-0501-W72	1mm	White	72	\$56.95
PQP-0588-W72	.88 mm	White	72	\$56.95
<b>Warm tone / Standard shape:</b>				
PQP-0100-V6	1 mm	Vintage	6	\$5.95
PQP-0088-V6	.88 mm	Vintage	6	\$5.95
PQP-0068-V6	.68 mm	Vintage	6	\$5.95
PQP-0100-V72	1 mm	Vintage	72	\$56.95
PQP-0088-V72	.88 mm	Vintage	72	\$56.95
PQP-0068-V72	.68 mm	Vintage	72	\$56.95

Model #	Thickness	Color	Pack	MSRP
<b>Warm tone / Bi Angle shape:</b>				
PQP-0402-V4	2 mm	Vintage	4	\$5.95
PQP-0401-V4	1 mm	Vintage	4	\$5.95
PQP-0488-V4	.88 mm	Vintage	4	\$5.95
PQP-0402-V48	2 mm	Vintage	48	\$56.95
PQP-0401-V48	1 mm	Vintage	48	\$56.95
PQP-0488-V48	.88 mm	Vintage	48	\$56.95
<b>Warm tone / Tear Drop shape:</b>				
PQP-0514-V6	1.4 mm	Vintage	6	\$5.95
PQP-0501-V6	1mm	Vintage	6	\$5.95
PQP-0588-V6	.88 mm	Vintage	6	\$5.95
PQP-0514-V72	1.4 mm	Vintage	72	\$56.95
PQP-0501-V72	1mm	Vintage	72	\$56.95
PQP-0588-V72	.88 mm	Vintage	72	\$56.95
<b>Deep tone / Standard shape:</b>				
PQP-0100-G6	1 mm	Grey	6	\$5.95
PQP-0088-G6	.88 mm	Grey	6	\$5.95
PQP-0068-G6	.68 mm	Grey	6	\$5.95
PQP-0100-G72	1 mm	Grey	72	\$56.95
PQP-0088-G72	.88 mm	Grey	72	\$56.95
PQP-0068-G72	.68 mm	Grey	72	\$56.95
<b>Deep tone / Bi Angle shape:</b>				
PQP-0402-G4	2 mm	Grey	4	\$5.95
PQP-0401-G4	1 mm	Grey	4	\$5.95
PQP-0488-G4	.88 mm	Grey	4	\$5.95
PQP-0402-G48	2 mm	Grey	48	\$56.95
PQP-0401-G48	1 mm	Grey	48	\$56.95
PQP-0488-G48	.88 mm	Grey	48	\$56.95
<b>Deep tone / Tear Drop shape:</b>				
PQP-0514-G6	1.4 mm	Grey	6	\$5.95
PQP-0501-G6	1mm	Grey	6	\$5.95
PQP-0588-G6	.88 mm	Grey	6	\$5.95
PQP-0514-G72	1.4 mm	Grey	72	\$56.95
PQP-0501-G72	1mm	Grey	72	\$56.95
PQP-0588-G72	.88 mm	Grey	72	\$56.95

# GRAPH TECH®

## I.K. (Guitar Nuts, Saddles and Bridge Pins)

**T**  
MAN-MADE IVORY



**TUSQ delivers the optimum frequencies from the strings to the guitar top, producing a richer and fuller tone.**

Guitar makers and players agree.....acoustic guitars come alive with TUSQ man-made ivory. TUSQ is simply more efficient at transferring vibration to your guitar top, resulting in big open lows and clear bell like highs. TUSQ is consistent from piece to piece, and within each piece, to offer you harmonically rich tones without the problems associated with natural materials.

Model #	Color	Dot	Shank Diameter	Qty	MSRP	Model #	Color	Dot	Qty	MSRP
<b>BRIDGE PINS</b>						<b>END PINS</b>				
PP-0000	White	No	0.2020"/5.14mm	6-Pcs	\$21.55	PP-7100	White	No	6-Pcs	\$12.95
PP-0000	Black	No	0.2020"/5.14mm	6-Pcs	\$21.55	PP-7142	White	Mother of Pearl	6-Pcs	\$16.95
PP-1122	White	2mm Black	0.2020"/5.14mm	6-Pcs	\$24.95	PP-7182	White	Paua shell	6-Pcs	\$16.95
PP-2122	Black	2mm White	0.2020"/5.14mm	6-Pcs	\$24.95	PP-7211	Black	No	6-Pcs	\$12.95
PP-1142	White	2mm Mother of Pearl	0.2020"/5.14mm	6-Pcs	\$27.95	PP-7242	Black	Mother of Pearl	6-Pcs	\$16.95
PP-2142	Black	2mm Mother of Pearl	0.2020"/5.14mm	6-Pcs	\$27.95	PP-7282	Black	Paua shell	6-Pcs	\$16.95
PP-1182	White	2mm Paua shell	0.2020"/5.14mm	6-Pcs	\$27.95					
PP-2182	Black	2mm Paua shell	0.2020"/5.14mm	6-Pcs	\$27.95					
PP-1000	White	4mm Paua shell	0.1920"/4.93mm	6-Pcs	\$27.95					
PP-2000	Black	4mm Paua shell	0.1920"/4.93mm	6-Pcs	\$27.95					
PP-1044	White	4mm Mother of Pearl	0.1920"/4.93mm	6-Pcs	\$27.95					
PP-2044	Black	4mm Mother of Pearl	0.1920"/4.93mm	6-Pcs	\$27.95					
PP-4000	White	No	0.1920"/4.93mm	6-Pcs	\$21.55					
PP-3000	Black	No	0.1920"/4.93mm	6-Pcs	\$21.55					

**PQ-1214**  
**\$13.65**

**Fender® Jazz Style 4 String Bass Nut**  
Fits most Fender® Jazz 4 String Bases

	LENGTH	THICKNESS	HEIGHT	E TO E
Inches	1.554	0.128	0.187	1.223
Inches Approx.	1 9/16	1/8	3/16	1 7/32
Millimetres	39.47	3.25	4.75	31.06

**PQ-1575**  
**\$13.65**

**12 String 1/4" Slotted Guitar Nut**

	LENGTH	THICKNESS	HEIGHT	E TO E
Inches	1.750	0.247	0.334	1.460
Inches Approx.	1 3/4	1/4	11/32	1 15/32
Millimetres	44.45	6.27	8.48	37.08

**PQ-5000**  
**\$13.65**

**Fender® Style Slotted Guitar Nut**  
Fits most American & Import Strat® & Tele® Style guitars

	LENGTH	THICKNESS	HEIGHT	E TO E
Inches	1.690	0.134	0.200	1.380
Inches Approx.	1 11/16	1/8	3/16	1 3/8
Millimetres	42.93	3.40	5.08	35.05

**PQ-1000**  
**\$13.65**

**Curved Bottom Blank Guitar Nut**  
Fits most American made Strat® style guitars with a curved nut slot

	LENGTH	THICKNESS	HEIGHT	E TO E
Inches	1.75	0.123	0.175	NA
Inches Approx.	1 3/4	1/8	3/16	NA
Millimetres	44.45	3.12	4.45	NA

**PQ-1578**  
**\$13.65**

**12 String 3/16" Slotted Guitar Nut**

	LENGTH	THICKNESS	HEIGHT	E TO E
Inches	1.897	0.195	0.325	1.630
Inches Approx.	1 29/32	3/16	5/16	1 5/8
Millimetres	48.18	4.95	8.25	41.4

**PQ-5010**  
**\$13.65**

**Fender® Style Flat Bottom Slotted Guitar Nut**  
Fits many import Strats® and Tele® requiring a flat bottom

	LENGTH	THICKNESS	HEIGHT	E TO E
Inches	1.764	0.130	0.255	1.362
Inches Approx.	1 3/4	1/8	1/4	1 3/8
Millimetres	44.81	3.30	6.48	34.59

**PQ-1200**  
**\$13.65**

**4 String Slotted Bass Nut**

	LENGTH	THICKNESS	HEIGHT	E TO E
Inches	1.615	0.182	0.348	1.224
Inches Approx.	1 5/8	3/16	11/32	1 7/32
Millimetres	41.02	4.62	8.84	31.09

**PQ-2200**  
**\$13.65**

**Standard Blank Guitar Nut**  
Fits most import Strat® style guitars with a flat nut slot

	LENGTH	THICKNESS	HEIGHT	E TO E
Inches	1.750	0.125	0.244	NA
Inches Approx.	1 3/4	1/8	1/4	NA
Millimetres	44.45	3.17	6.20	NA

**PQ-6010**  
**\$13.65**

**Jumbo Gibson® Style Slotted Guitar Nut**  
Fits most Gibson 6 string electric guitars.

	LENGTH	THICKNESS	HEIGHT	E TO E
Inches	1.735	0.196	0.366	1.425
Inches Approx.	1 3/4	3/16	3/8	1 7/16
Millimetres	44.07	4.98	9.30	36.20

**PQ-1204**  
**\$13.65**

**Fender® Precision Style 4 String Bass Nut**  
Fits most Fender® Precision Bases

	LENGTH	THICKNESS	HEIGHT	E TO E
Inches	1.650	0.125	0.187	1.250
Inches Approx.	1 21/32	1/8	3/16	1 1/4
Millimetres	41.91	3.17	4.75	31.75

**PQ-4000**  
**\$13.65**

**Jumbo 3/16" Blank Guitar Nut**

	LENGTH	THICKNESS	HEIGHT	E TO E
Inches	1.905	0.192	0.375	NA
Inches Approx.	1 29/32	3/16	3/8	NA
Millimetres	48.39	4.88	9.52	NA

**PQ-6060**  
**\$13.65**

**1/4" Epiphone® Style Slotted Guitar Nut**  
Fits many Epiphone® Style guitars

	LENGTH	THICKNESS	HEIGHT	E TO E
Inches	1.732	0.242	0.362	1.366
Inches Approx.	1 3/4	1/4	3/8	1 3/8
Millimetres	43.99	6.14	9.19	34.70

**PQ-1250**  
**\$13.65**

**1-13/32" Slotted Ukulele Nut**

	LENGTH	THICKNESS	HEIGHT	E TO E
Inches	1.402	0.140	0.222	1.137
Inches Approx.	1 13/32	1/8	7/32	1 1/8
Millimetres	35.61	3.56	5.64	28.88

**PQ-4025**  
**\$13.65**

**Jumbo 3/16" Blank Guitar Nut**

	LENGTH	THICKNESS	HEIGHT	E TO E
Inches	2.500	250	0.437	NA
Inches Approx.	2 1/2	1/4	7/16	NA
Millimetres	63.50	6.35	11.10	NA

**PQ-6114**  
**\$13.65**

**1 23/32" Slotted Guitar Nut**  
Fits many acoustic guitars with a 1 23/32" nut length

	LENGTH	THICKNESS	HEIGHT	E TO E
Inches	1.705	0.195	0.332	1.374
Inches Approx.	1 23/32	3/16	11/32	1 3/8
Millimetres	43.31	4.95	8.43	34.90

**PQ-1400**  
**\$13.65**

**5 String Slotted Bass Nut**

	LENGTH	THICKNESS	HEIGHT	E TO E
Inches	1.765	0.187	0.348	1.435
Inches Approx.	1 3/4	3/16	11/32	1 7/16
Millimetres	44.83	4.75	8.84	36.45

**PQ-4125**  
**\$13.65**

**Jumbo 3/16" Blank Guitar Nut**

	LENGTH	THICKNESS	HEIGHT	E TO E
Inches	2.500	0.125	7.92	NA
Inches Approx.	2 1/2	1/8	5/16	NA
Millimetres	63.5	3.17	7.92	NA

**PQ-6116**  
**\$13.65**

**1 11/16" Slotted Guitar Nut**  
Fits many acoustic guitars with a 1 11/16" nut length

	LENGTH	THICKNESS	HEIGHT	E TO E
Inches	1.707	0.192	0.331	1.435
Inches Approx.	1 11/16	3/16	11/32	1 7/8
Millimetres	43.36	4.88	8.81	36.45

**PQ-1530**  
**\$13.65**

**1-5/8" Slotted Mandolin Nut**

	LENGTH	THICKNESS	HEIGHT	E TO E
Inches	1.145	0.186	0.329	0.965
Inches Approx.	1 5/32	3/16	11/32	31/32
Millimetres	29.08	4.72	8.36	24.51

**PQ-4187**  
**\$13.65**

**Jumbo 3/16" Blank Guitar Nut**

	LENGTH	THICKNESS	HEIGHT	E TO E
Inches	2.500	0.187	0.437	NA
Inches Approx.	2 1/2	3/16	7/16	NA
Millimetres	63.5	4.75	11.10	NA

**PQ-6134**  
**\$13.65**

**1 3/4" Slotted Acoustic Nut**  
Fits many acoustic guitars with a 1 3/4" nut length

	LENGTH	THICKNESS	HEIGHT	E TO E
Inches	1.770	0.192	0.331	1.496
Inches Approx.	1 3/4	3/16	11/32	1 1/2
Millimetres	44.96	4.88	8.41	38.0

**PQ-1535**  
**\$13.65**

**1-3/16" Slotted Mandolin Nut**

	LENGTH	THICKNESS	HEIGHT	E TO E
Inches	1.197	0.162	0.299	0.975
Inches Approx.	1 3/16	5/32	5/16	31/32
Millimetres	30.40	4.11	7.59	24.77

**PQ-4300**  
**\$13.65**

**1-15/16" Blank Classical Nut**

	LENGTH	THICKNESS	HEIGHT	E TO E
Inches	1.936	0.189	0.305	NA
Inches Approx.	1 15/16	3/16	5/16	NA
Millimetres	49.17	4.80	7.75	NA

**PQ-6136**  
**\$13.65**

**1 13/16 Slotted Guitar Nut**

	LENGTH	THICKNESS	HEIGHT	E TO E
Inches	1.830	0.187	0.341	1.555
Inches Approx.	1 27/32	3/16	11/32	1 9/16
Millimetres	46.48	4.75	8.66	39.50

# GRAPH TECH®

PQ-6200  
\$13.65

Classical Slotted Guitar Nut				
	LENGTH	THICKNESS	HEIGHT	E TO E
Inches	2.080	0.235	0.409	1.697
Inches Approx.	2 3/32	1/4	13/32	1 11/16
Millimetres	52.83	5.97	10.39	43.10

PQ-6220  
\$13.65

2" Classical Slotted Guitar Nut				
	LENGTH	THICKNESS	HEIGHT	E TO E
Inches	2.002	0.251	0.372	1.634
Inches Approx.	2	1/4	3/8	1 5/8
Millimetres	50.85	6.38	9.45	41.50

PQ-6226  
\$13.65

1-5/8" Slotted Acoustic or Electric Guitar Nut				
	LENGTH	THICKNESS	HEIGHT	E TO E
Inches	1.625	0.240	0.230	1.365
Inches Approx.	1 5/8	1/4	7/32	1 3/8
Millimetres	41.15	6.10	5.84	34.67

PQ-6400  
\$13.65

1-3/4" Slotted Gibson Style Acoustic Guitar Nut				
	LENGTH	THICKNESS	HEIGHT	E TO E
Inches	1.753	0.196	0.320	1.460
Inches Approx.	1 3/4	13/64	11/32	1 15/32
Millimetres	44.64	4.94	8.05	37.44

PQ-M644  
\$13.65

1 3/4" Martin® Style Slotted Guitar Nut Fits Martin® Style guitars with 1 3/4" length				
	LENGTH	THICKNESS	HEIGHT	E TO E
Inches	1.745	0.224	0.361	1.418
Inches Approx.	1 3/4	7/32	3/8	1 13/32
Millimetres	44.32	5.69	9.17	36.02

PQ-M600  
\$13.65

Martin® Style 1 11/16" Slotted Guitar Nut Fits Martin® Style guitars where the nut bottom and sides are angled				
	LENGTH	THICKNESS	HEIGHT	E TO E
Inches	1.709	0.228	0.361	1.378
Inches Approx.	1 11/16	7/32	3/8	1 3/8
Millimetres	43.41	5.79	9.17	35.00

PQ-9025  
\$16.75

1/4" Acoustic Saddle Slab				
	LENGTH	THICKNESS	HEIGHT	E TO E
Inches	4.000	0.250	0.500	
Inches Approx.	4	1/4	412	
Millimetres	101.6	6.35	12.7	

PQ-9100  
\$13.65

3/32" Martin® Style Acoustic Saddle Fits many Martin® style acoustic guitars				
	LENGTH	THICKNESS	HEIGHT	E TO E
Inches	2.908	0.101	0.383	
Inches Approx.	2 29/32	3/32	3/8	
Millimetres	73.86	2.57	9.73	

PQ-9110  
\$13.65

3/32" Martin® Style Compensated Acoustic Saddle Fits many Acoustic Martin® style guitars				
	LENGTH	THICKNESS	HEIGHT	E TO E
Inches	2.900	0.093	0.400	
Inches Approx.	2 29/32	3/32	13/32	
Millimetres	73.66	2.36	10.16	

PQ-9125  
\$13.65

1/8" Acoustic Saddle Slab				
	LENGTH	THICKNESS	HEIGHT	E TO E
Inches	4.000	0.125	0.500	
Inches Approx.	4	1/8	1/2	
Millimetres	101.60	3.17	12.7	

PQ-9200-C0  
\$13.65

1/8" Taylor® Style Compensated Acoustic Saddle Fits many Taylor®, Gibson®, Washburn® & more				
	LENGTH	THICKNESS	HEIGHT	E TO E
Inches	2.800	0.122	0.393	
Inches Approx.	2 13/16	1/8	13/32	
Millimetres	71.12	3.1	9.98	

PQ-9208  
\$13.65

Classical Compensated Low Acoustic Saddle Compensated for better intonation - nylon string guitars				
	LENGTH	THICKNESS	HEIGHT	E TO E
Inches	3.150	0.101	0.323	
Inches Approx.	3 5/32	3/32	5/16	
Millimetres	80.01	2.57	8.20	

PQ-9210  
\$13.65

Classical Tall Acoustic Saddle Compensated for better intonation - nylon string guitars				
	LENGTH	THICKNESS	HEIGHT	E TO E
Inches	3.150	0.101	0.394	
Inches Approx.	3 5/32	3/32	13/32	
Millimetres	80.01	2.57	10.01	

PQ-9276-C0  
\$13.65

3" Compensated Acoustic Saddle Fits Alvarez® guitars				
	LENGTH	THICKNESS	HEIGHT	E TO E
Inches	3.000	0.128	0.440	
Inches Approx.	3	1/8	7/16	
Millimetres	76.38	3.25	11.17	

PQ-9280-C0  
\$13.65

1/8" Fully Compensated Acoustic Saddle Fits many Seagull®, Art and Lutherie® & more				
	LENGTH	THICKNESS	HEIGHT	E TO E
Inches	2.880	0.128	0.430	
Inches Approx.	2 7/8	1/8	7/16	
Millimetres	73.15	3.25	10.92	

PQ-9400  
\$13.65

Gibson® Style Compensated Acoustic Saddle Fits many Gibson® style acoustic guitars				
	LENGTH	THICKNESS	HEIGHT	E TO E
Inches	2.800	0.130	0.430	
Inches Approx.	2 13/16	1/8	7/16	
Millimetres	71.12	3.30	10.92	

PQ-9600-C0  
\$15.95

Microbalance 12" Radius Acoustic Saddle Ideal for under saddle pickups on an acoustic guitar				
	LENGTH	THICKNESS	HEIGHT	E TO E
Inches	2.806	0.126	0.331	
Inches Approx.	2 13/16	1/8	11/32	
Millimetres	71.27	3.20	8.41	

PQ-9332  
\$13.65

3/32" Saddle Slab				
	LENGTH	THICKNESS	HEIGHT	E TO E
Inches	4.000	0.094	0.500	
Inches Approx.	4	3/32	1/2	
Millimetres	101.6	2.39	12.7	

## I.K. (Guitar Nuts, Saddles and Bridge Pins)



**Play Harder, Faster, Longer and stay in tune!**

TUSQ XL is impregnated with PTFE, the slipperiest substance on earth which alleviates the binding grip the nut has on the strings. Strings simply glide back into tune! Engineered from the same material as our highly esteemed TUSQ, it has all the tonal benefits of TUSQ, bringing out the hidden harmonics by transferring string vibrations efficiently to the guitar.

PQL-1214  
\$14.95

Fender® Jazz Bass Style 4 String Nut Fits most Fender® style Jazz basses				
	LENGTH	THICKNESS	HEIGHT	E TO E
Inches	1.554	0.128	0.187	1.223
Inches Approx.	1 9/16	1/8	3/16	1 7/32
Millimetres	39.47	3.25	4.75	31.08

PQL-1204  
\$14.95

Fender® Pre Bass Style 4 String Nut Fits most Fender® style Pre basses				
	LENGTH	THICKNESS	HEIGHT	E TO E
Inches	1.650	0.125	0.187	1.250
Inches Approx.	1 21/32	18/8	3/16	1 1/4
Millimetres	41.91	3.17	4.75	31.75

PQL-5000  
\$14.95

Strat® Style Slotted Guitar Nut Fits most American & Import Strat® & Tele® Style guitars				
	LENGTH	THICKNESS	HEIGHT	E TO E
Inches	1.690	0.134	0.200	1.380
Inches Approx.	1 11/16	1/8	3/16	1 3/8
Millimetres	42.93	3.40	5.08	35.05

PQL-5000-L0  
\$14.95

Left Handed Strat® Style Slotted Guitar Nut Fits most American & Import Strat® & Tele® Style guitars				
	LENGTH	THICKNESS	HEIGHT	E TO E
Inches	1.690	0.134	0.200	1.380
Inches Approx.	1 11/16	1/8	3/16	1 3/8
Millimetres	42.93	3.40	5.08	35.05

PQL-6060  
\$14.95

1/4" Epiphone® Style Slotted Guitar Nut Fits many Epiphone® style guitars				
	LENGTH	THICKNESS	HEIGHT	E TO E
Inches	1.732	0.242	0.362	1.366
Inches Approx.	1 3/4	1/4	3/8	1 3/8
Millimetres	43.99	6.14	9.19	34.70

PQL-6060-L0  
\$14.95

Left Handed 1/4" Epiphone® Style Slotted Guitar Nut Fits many Epiphone® style left handed guitars				
	LENGTH	THICKNESS	HEIGHT	E TO E
Inches	1.732	0.242	0.362	1.366
Inches Approx.	1 3/4	1/4	3/8	1 3/8
Millimetres	43.99	6.14	9.19	34.70

PQL-6010  
\$14.95

Jumbo Gibson® Style Slotted Guitar Nut Fits most Gibson® 6 string electric guitars.				
	LENGTH	THICKNESS	HEIGHT	E TO E
Inches	1.735	0.196	0.366	1.425
Inches Approx.	1 3/4	3/16	3/8	1 7/16
Millimetres	44.07	4.98	9.30	36.20

PQL-5010  
\$14.95

Fender® Style Flat Bottom Slotted Guitar Nut Fits many import Strat® and Tele® requiring a flat bottom				
	LENGTH	THICKNESS	HEIGHT	E TO E
Inches	1.764	0.130	0.255	1.362
Inches Approx.	1 3/4	1/8	1/4	1 3/8
Millimetres	44.81	3.30	6.48	34.59

PQL-1000  
\$14.95

Blank Standard Guitar Nut Fits most American made Strat® style guitars with a curved nut slot				
	LENGTH	THICKNESS	HEIGHT	E TO E
Inches	1.750	0.123	0.342	NA
Inches Approx.	1 3/4	1/8	3/16	NA
Millimetres	44.45	3.12	4.45	NA

PQL-2200  
\$14.95

Blank Standard Guitar Nut Fits most American made Strat® style guitars with a flat bottom slot				
	LENGTH	THICKNESS	HEIGHT	E TO E
Inches	1.750	0.125	0.244	NA
Inches Approx.	1 3/4	1/8	1/4	NA
Millimetres	44.45	3.17	6.20	NA

PQL-4000  
\$14.95

Blank Extra Large Jumbo Nut Fits many acoustics such as Gibson®, Guild®, Larrivee® & more				
	LENGTH	THICKNESS	HEIGHT	E TO E
Inches	1.905	0.192	0.385	NA
Inches Approx.	1 29/32	3/16	3/8	NA
Millimetres	48.39	4.88	9.77	NA

PQL-7004  
\$14.95

Sleek String Trees One long and two short. Two short string trees can be sanded on the bottom to get the perfect height on any guitar.				
	LENGTH	THICKNESS	HEIGHT	E TO E
Inches	4.000	0.130	0.255	1.362
Inches Approx.	4	1/8	1/4	1 3/8
Millimetres	101.6	3.30	6.48	34.59



## I.K. (Guitar Nuts, Saddles and Bridge Pins)



**Black TUSQ XL keeps your guitar in tune through aggressive playing, shredding, string bends and/or heavy tremolo use**

Black TUSQ XL, impregnated with PTFE, the slipperiest substance on earth, alleviates the binding grip the nut has on the strings. Strings simply glide back into tune! Black TUSQ XL is based on the highly resonant TUSQ man-made ivory providing superior tone on all open notes. It has the benefits of TUSQ, giving you a dramatic increase in tuning stability for your string bends and heavy tremolo use.

**PT-1214  
\$13.65**

**Fender® Jazz Bass Style 4 String Nut**  
Fits most Fender® style Jazz basses

	LENGTH	THICKNESS	HEIGHT	E TO E
Inches	1.554	0.128	0.187	1.223
Inches Approx.	1 9/16	1/8	3/16	1 7/32
Millimetres	39.47	3.25	4.75	31.08

**PT-1200  
\$13.65**

**4 String Bass Nut**

	LENGTH	THICKNESS	HEIGHT	E TO E
Inches	1.620	0.184	0.368	1.238
Inches Approx.	1 5/8	3/16	11/32	1 7/32
Millimetres	41.17	4.68	9.34	31.34

**PT-1204  
\$13.65**

**Fender® Precision Bass Style 4 String Nut**  
Fits most Fender® style Pre basses

	LENGTH	THICKNESS	HEIGHT	E TO E
Inches	1.650	0.125	0.187	1.250
Inches Approx.	1 21/32	1/8	3/16	1 1/4
Millimetres	41.91	3.17	4.75	31.75

**PT-1400  
\$13.65**

**5 String Bass Nut**

	LENGTH	THICKNESS	HEIGHT	E TO E
Inches	1.765	0.187	0.348	1.435
Inches Approx.	1 3/4	3/16	11/32	1 7/16
Millimetres	44.83	4.75	8.84	36.45

**PT-5000  
\$13.65**

**Strat® Style Slotted Guitar Nut**  
Fits most American & Import Strat® & Tele® Styles guitars

	LENGTH	THICKNESS	HEIGHT	E TO E
Inches	1.690	0.134	0.200	1.380
Inches Approx.	1 11/16	1/8	3/16	1 3/8
Millimetres	42.93	3.40	5.08	35.05

**PT-6060  
\$13.65**

**1/4" Epiphone® Style Slotted Guitar Nut**  
Fits many Epiphone® Style guitars

	LENGTH	THICKNESS	HEIGHT	E TO E
Inches	1.732	0.242	0.362	1.366
Inches Approx.	1 3/4	1/4	3/8	1 3/8
Millimetres	43.99	6.14	9.19	34.70

**PT-6000  
\$13.65**

**Jumbo Slotted Guitar Nut**  
Fits most 6 string electric guitars.

	LENGTH	THICKNESS	HEIGHT	E TO E
Inches	1.735	0.196	0.329	1.425
Inches Approx.	1 3/4	3/16	11/32	1 7/16
Millimetres	44.07	4.98	8.36	36.20

**PT-6010  
\$13.65**

**Jumbo Gibson® Style Slotted Guitar Nut**  
Fits most Gibson 6 string electric guitars.

	LENGTH	THICKNESS	HEIGHT	E TO E
Inches	1.735	0.196	0.366	1.425
Inches Approx.	1 3/4	3/16	3/8	1 7/16
Millimetres	44.07	4.98	9.30	36.20

**PT-5010  
\$13.65**

**Fender® Style Flat Bottom Slotted Guitar Nut**  
Fits many import Strats® and Teles® requiring a flat bottom

	LENGTH	THICKNESS	HEIGHT	E TO E
Inches	1.764	0.130	0.255	1.362
Inches Approx.	1 3/4	1/8	1/4	1 3/8
Millimetres	44.81	3.30	6.48	34.59

**PT-1000  
\$13.65**

**Blank Standard Guitar Nut**  
Fits most American made Strat® style guitars with a curved nut slot

	LENGTH	THICKNESS	HEIGHT	E TO E
Inches	1.701	0.188	0.342	NA
Inches Approx.	1 11/16	3/16	11/32	NA
Millimetres	43.21	4.73	8.69	NA

**PT-2200  
\$13.65**

**Blank Standard Guitar Nut**  
Fits most American made Fender® style guitars with a flat bottom slot

	LENGTH	THICKNESS	HEIGHT	E TO E
Inches	1.750	0.123	0.175	NA
Inches Approx.	1 3/4	1/8	3/16	NA
Millimetres	44.45	3.12	4.45	NA

**PT-4000  
\$13.65**

**Blank Extra Large Jumbo Nut**  
Fits many acoustics such as Gibson®, Guild®, Larrivee® & more

	LENGTH	THICKNESS	HEIGHT	E TO E
Inches	1.905	0.192	0.375	NA
Inches Approx.	1 29/32	3/16	3/8	NA
Millimetres	48.39	4.88	9.52	NA

**PT-9200-C0  
\$13.65**

**1/8" Taylor® Style Compensated Acoustic Saddle**  
Fits many Taylor®, Gibson®, Washburn® & more

	LENGTH	THICKNESS	HEIGHT
Inches	2.800	0.122	0.393
Inches Approx.	2 13/16	1/8	13/32
Millimetres	71.12	3.1	9.98

**PT-9280-C0  
\$13.65**

**1/8" Fully Compensated Acoustic Saddle**  
Fits many Seagull®, Art and Lutherie® & more

	LENGTH	THICKNESS	HEIGHT
Inches	2.880	0.128	0.430
Inches Approx.	2 7/8	1/8	7/16
Millimetres	73.15	3.25	10.92

**PT-9110  
\$13.65**

**3/32" Martin® Style Compensated Acoustic Saddle**  
Fits many acoustic Martin® style guitars

	LENGTH	THICKNESS	HEIGHT
Inches	2.900	0.093	0.400
Inches Approx.	2 29/32	3/32	13/32
Millimetres	73.66	2.36	10.16

**PT-9100  
\$13.65**

**3/32" Martin® Style Acoustic Saddle**  
Fits many Martin® style acoustic guitars

	LENGTH	THICKNESS	HEIGHT
Inches	2.908	0.101	0.383
Inches Approx.	2 29/32	3/32	3/8
Millimetres	73.86	2.57	9.73

**PT-9000  
\$13.65**

**1/8" Blank Acoustic Saddle**

	LENGTH	THICKNESS	HEIGHT
Inches	3.020	0.124	0.450
Inches Approx.	3 1/32	1/8	7/16
Millimetres	76.71	3.15	11.43

**PT-9600-C0  
\$15.95**

**Microbalance 12" Radius Acoustic Saddle**  
Ideal for under saddle pickups on an acoustic guitar

	LENGTH	THICKNESS	HEIGHT
Inches	2.806	0.126	0.331
Inches Approx.	2 13/16	1/8	11/32
Millimetres	71.27	3.20	8.41

**PT-9650-C0  
\$15.95**

**Microbalance 16" Radius Acoustic Saddle**  
Ideal for under saddle pickups on an acoustic guitar

	LENGTH	THICKNESS	HEIGHT
Inches	2.806	0.126	0.331
Inches Approx.	2 13/16	1/8	11/32
Millimetres	71.27	3.20	8.41

**PT-9025  
\$16.75**

**1/4" Acoustic Saddle Slab**

	LENGTH	THICKNESS	HEIGHT
Inches	4.000	0.250	0.500
Inches Approx.	4	1/4	1/2
Millimetres	101.6	6.35	12.7

**PT-9125  
\$13.65**

**1/8" Acoustic Saddle Slab**

	LENGTH	THICKNESS	HEIGHT
Inches	4.000	0.125	0.500
Inches Approx.	4	1/8	1/2
Millimetres	101.6	3.17	12.7

**PT-9332  
\$13.65**

**3/32" Acoustic Saddle Slab**

	LENGTH	THICKNESS	HEIGHT
Inches	4.000	0.094	0.500
Inches Approx.	4	3/32	1/2
Millimetres	101.6	2.39	12.7

**PT-7004  
\$13.65**

**Sleek String Trees**  
With two short and one long chrome screw

Two short string trees can be sanded on the bottom to get the perfect height on any guitar.

**PT-5001  
\$24.30**

**Strat® Style Retainer Pack**  
Slotted PT-5000-00 nut and two sleek string trees

Fits many Strat® style guitars with a curved or flat bottom nut slot.

## I.K. (Guitar Nuts, Saddles and Bridge Pins)

Why use plastic when you can have tone...  
**NUBONE®**  
 PRECISION ENGINEERED  
 NUTS AND SADDLES



**There is no reason to accept a cheap plastic nut or saddle when you can add tone with NuBone**

NuBone is a derivative of our highly resonant TUSQ material, manufactured to very close tolerances under high heat and pressure. NuBone delivers clear highs, a nice low end with overall fullness and a balanced sound that has increased harmonics and volume. With similar tonal characteristics to our highly esteemed TUSQ, NuBone doesn't dampen vibration like plastic.

**LC-1214-10**  
**(Pack of 10)**  
**\$57.95**

Fender® Jazz Style 4 String Bass Nut Fits most Fender® Jazz 4 String Bases				
	LENGTH	THICKNESS	HEIGHT	E TO E
Inches	1.554	0.128	0.187	1.223
Inches Approx.	1 9/16	1/8	3/16	1 7/32
Millimetres	39.47	3.25	4.75	31.06

**LC-6010-10**  
**(Pack of 10)**  
**\$57.95**

Jumbo Gibson® Style Slotted Guitar Nut Fits most Gibson 6 string electric guitars.				
	LENGTH	THICKNESS	HEIGHT	E TO E
Inches	1.735	0.196	0.366	1.425
Inches Approx.	1 3/4	3/16	3/8	1 7/16
Millimetres	44.07	4.98	9.30	36.20

**LC-9280-C0**  
**\$57.95**

1/8" Fully Compensated Acoustic Saddle Fits many Seagull®, Art and Lutherie® & more			
	LENGTH	THICKNESS	HEIGHT
Inches	2.880	0.128	0.430
Inches Approx.	2 7/8	1/8	7/16
Millimetres	73.15	3.25	10.92

**LC-1204-10**  
**(Pack of 10)**  
**\$57.95**

Fender® Precision Style 4 String Bass Nut Fits most Fender® Precision Bases				
	LENGTH	THICKNESS	HEIGHT	E TO E
Inches	1.650	0.125	0.187	1.250
Inches Approx.	1 21/32	1/8	3/16	1 1/4
Millimetres	41.91	3.17	4.75	31.75

**LC-5010-10**  
**(Pack of 10)**  
**\$57.95**

Fender® Style Flat Bottom Slotted Guitar Nut Fits many import Strats® and Teles® requiring a flat bottom				
	LENGTH	THICKNESS	HEIGHT	E TO E
Inches	1.764	0.130	0.255	1.362
Inches Approx.	1 3/4	1/8	1/4	1 3/8
Millimetres	44.81	3.30	6.48	34.59

**LC-9208-10**  
**\$57.95**

Classical Compensated Low Acoustic Saddle Compensated for better intonation - nylon string guitars			
	LENGTH	THICKNESS	HEIGHT
Inches	3.150	0.101	0.323
Inches Approx.	3 5/32	3/32	5/16
Millimetres	80.01	2.57	8.20

**LC-5000-10**  
**(Pack of 10)**  
**\$57.95**

Fender® Style Slotted Guitar Nut Fits most American & Import Strat® & Tele® Style guitars				
	LENGTH	THICKNESS	HEIGHT	E TO E
Inches	1.690	0.134	0.200	1.380
Inches Approx.	1 11/16	1/8	3/16	1 3/8
Millimetres	42.93	3.40	5.08	35.05

**LC-1000-10**  
**(Pack of 10)**  
**\$57.95**

Curved Bottom Blank Guitar Nut Fits most American made Fender® style guitars with a curved nut slot				
	LENGTH	THICKNESS	HEIGHT	E TO E
Inches	1.75	0.123	0.175	NA
Inches Approx.	1 3/4	1/8	3/16	NA
Millimetres	44.45	3.12	4.45	NA

**LC-9110-10**  
**\$57.95**

3/32" Martin® Style Compensated Acoustic Saddle Fits many Acoustic Martin® style guitars			
	LENGTH	THICKNESS	HEIGHT
Inches	2.900	0.093	0.400
Inches Approx.	2 29/32	3/32	13/32
Millimetres	73.66	2.36	10.16

**LC-6114-10**  
**(Pack of 10)**  
**\$57.95**

1 23/32" Slotted Guitar Nut Fits many acoustic guitars with a 1 23/32" nut length				
	LENGTH	THICKNESS	HEIGHT	E TO E
Inches	2.080	0.235	0.409	1.697
Inches Approx.	1 23/32	1/4	13/32	1 11/16
Millimetres	52.83	5.97	10.39	43.10

**LC-2200-10**  
**(Pack of 10)**  
**\$57.95**

Standard Blank Guitar Nut Fits most import Fender® style guitars with a flat nut slot				
	LENGTH	THICKNESS	HEIGHT	E TO E
Inches	1.750	0.125	0.244	NA
Inches Approx.	1 3/4	1/8	1/4	NA
Millimetres	44.45	3.17	6.20	NA

**LC-9210-10**  
**\$57.95**

Classical Tall Acoustic Saddle Compensated for better intonation - nylon string guitars			
	LENGTH	THICKNESS	HEIGHT
Inches	3.150	0.101	0.394
Inches Approx.	3 5/32	3/32	13/32
Millimetres	80.01	2.57	10.01

**LC-6116-10**  
**(Pack of 10)**  
**\$57.95**

1 11/16" Slotted Guitar Nut Fits many acoustic guitars with a 1 11/16" nut length				
	LENGTH	THICKNESS	HEIGHT	E TO E
Inches	1.705	0.195	0.332	1.374
Inches Approx.	1 11/16	3/16	11/32	1 3/8
Millimetres	43.31	4.95	8.43	34.90

**LC-4000-10**  
**(Pack of 10)**  
**\$57.95**

Jumbo Blank Guitar Nut				
	LENGTH	THICKNESS	HEIGHT	E TO E
Inches	1.905	0.192	0.375	NA
Inches Approx.	1 29/32	3/16	3/8	NA
Millimetres	48.39	4.88	9.52	NA

**LC-9600-10**  
**\$80.75**

Microbalance 12" Radius Acoustic Saddle Ideal for under saddle pickups on an acoustic guitar			
	LENGTH	THICKNESS	HEIGHT
Inches	2.806	0.126	0.331
Inches Approx.	2 13/16	1/8	11/32
Millimetres	71.27	3.20	8.41

**LC-M600-10**  
**(Pack of 10)**  
**\$57.95**

Martin® Style 1 11/16" Slotted Guitar Nut Fits Martin® Style guitars where the nut bottom and sides are angled				
	LENGTH	THICKNESS	HEIGHT	E TO E
Inches	1.709	0.228	0.361	1.378
Inches Approx.	1 11/16	7/32	3/8	1 3/8
Millimetres	43.41	5.79	9.17	35.00

**LC-9200**  
**\$57.95**

1/8" Taylor® Style Acoustic Saddle Fits many Taylor®, Tacoma®, Gibson®, Washburn® & more			
	LENGTH	THICKNESS	HEIGHT
Inches	2.800	0.122	0.393
Inches Approx.	2 13/16	1/8	13/32
Millimetres	71.12	3.1	9.98

**LC-9650-10**  
**\$80.75**

Microbalance 16" Radius Acoustic Saddle Ideal for under saddle pickups on an acoustic guitar			
	LENGTH	THICKNESS	HEIGHT
Inches	2.806	0.126	0.331
Inches Approx.	2 13/16	1/8	11/32
Millimetres	71.27	3.20	8.41

**LC-6060-10**  
**(Pack of 10)**  
**\$57.95**

1/4" Epiphone® Style Slotted Guitar Nut Fits many Epiphone® Style guitars				
	LENGTH	THICKNESS	HEIGHT	E TO E
Inches	1.732	0.242	0.362	1.366
Inches Approx.	1 3/4	1/4	3/8	1 3/8
Millimetres	43.99	6.14	9.19	34.70

**LC-9400-10**  
**\$57.95**

Gibson® Style Acoustic Saddle Fits many Gibson® style acoustic guitars				
	LENGTH	THICKNESS	HEIGHT	
Inches	2.800	0.130	0.430	
Inches Approx.	2 13/16	1/8	7/16	
Millimetres	71.12	3.30	10.92	

## Master Luthier Kit

Contains 50 of our most popular nuts and saddles

With our NuBone Master Luthier Kit, you can easily do quick repairs on 85% of the guitars on the market. It comes in this easy to use box with actual size drawings of each item to make finding a nut or saddle quick and simple.

MC-1000  
 \$285.95

ITEM NUMBER	QTY	ITEM NUMBER	QTY
BC-5000-00	8	BC-M600-00	2
BC-6010-00	5	BC-M644-00	2
BC-6060-00	5	BC-6200-00	2
BC-6116-00	5	BC-9280-C0	8
BC-6134-00	5	BC-9110-00	4
BC-4000-00	2	BC-9210-00	2

# GRAPH TECH®

## I.K. (Guitar Nuts, Saddles and Bridge Pins)



No matter how hard you play, String Saver saddles dramatically reduce string breakage; We guarantee it!

String Saver saddles are guaranteed to dramatically reduce string breakage while providing full bodied tone and up to a 25% increase in sustain. String Saver saddles are impregnated with PTFE, a permanent lubricant which allows the strings to move microscopically, enough to take the stress off that one fixed breaking point. The result is that your strings last and last...

**PS-8000**  
**\$54.95**

Import Strat® & Tele® Style Saddle				
Fits most import Strat® style				
LENGTH	THICKNESS	HEIGHT	E TO E	
Inches	0.815	0.410	0.230	2.760
Inches Approx.	13/16	13/32	7/32	2 1/16
Millimetres	20.70	10.41	5.84	52.73

**PS-8000-F0**  
**\$54.95**

Vintage Strat® & Tele® Style Saddle				
Fits most vintage and vintage re-issue Strat® and Tele® styles				
LENGTH	THICKNESS	HEIGHT	E TO E	
Inches	0.820	0.440	0.230	2.179
Inches Approx.	13/16	7/16	7/21	2 3/16
Millimetres	20.83	11.18	5.84	55.35

**PS-8001**  
**\$54.95**

Offset Strat® & Tele® Style Saddle				
Fits Strat® and Tele® styles with an offset intonation screw				
LENGTH	THICKNESS	HEIGHT	E TO E	
Inches	0.815	0.410	0.230	2.076
Inches Approx.	13/16	13/32	7/32	2 1/16
Millimetres	20.70	10.41	5.84	52.73

**PS-8220**  
**\$54.95**

PRS® (Paul Reed Smith) Style Saddle				
Fits many PRS® style guitars. Slightly lower than our PS-8000-00				
LENGTH	THICKNESS	HEIGHT	E TO E	
Inches	0.815	0.410	0.230	2.076
Inches Approx.	13/16	13/32	7/32	2 1/16
Millimetres	20.70	10.41	5.84	52.73

**PS-8400**  
**\$39.95**

ABR-1 Tune-o-matic Saddles				
6 pieces 4/40 thread. Fits most Gibson® electric guitars with ABR-01 tune-o-matic bridges				
Pre-1972 guitars and vintage re-issues. The bridge has a small retaining wire running along the top of the intonation screw.				

**PS-8500**  
**\$39.95**

Gibson® Nashville Style Tune-o-matic Saddles				
6 pieces M3 x .50 thread. Gibson® Nashville tune-o-matic style saddles.				
Fits most Gibson® tune-o-matics made between 1972 and 2000.				

**PS-8200**  
**\$64.95**

Wilkinson® Style Saddle				
Set contains 3 different height saddles. Measure for highest saddle				
LENGTH	THICKNESS	HEIGHT	E TO E	
Inches	1.250	0.390	0.250	VARIABLE
Inches Approx.	1 1/4	3/8	1/4	VARIABLE
Millimetres	31.75	9.91	6.35	VARIABLE

**PS-8108**  
**\$54.95**

Adjustable Barrel Saddle				
Fits Jazzmaster®, Mustang®, & Jaguar® styles				
LENGTH	THICKNESS	HEIGHT	E TO E	
Inches	0.407	0.312	0.312	2.050
Inches Approx.	13/32	5/16	5/16	2 1/16
Millimetres	10.34	7.92	7.82	52.07

**PS-8163**  
**\$54.95**

I.O.S Tele® Style Barrel Saddle				
3 pieces Increased Oscillation & Sustain. Features accurate intonation points				
LENGTH	THICKNESS	HEIGHT	E TO E	
Inches	0.411	0.300	0.271	2.187
Inches Approx.	55/64	5/16	17/64	2 3/16
Millimetres	21.66	7.62	6.88	55.55

**PS-8166**  
**\$54.95**

I.O.S Tele® Style Barrel Saddle				
6 pieces Increased Oscillation & Sustain. Features accurate intonation points				
LENGTH	THICKNESS	HEIGHT	E TO E	
Inches	0.443	0.300	0.300	2.209
Inches Approx.	7/16	5/16	5/16	2 3/16
Millimetres	11.23	7.62	7.62	56.11

**PS-8501**  
**\$39.95**

Post Gibson® Tune-o-matic Saddles				
6 pieces M3 x .50 thread. Gibson® Nashville tune-o-matic style saddles.				
Fits most Gibson® tune-o-matics made after the year 2000. Also fits TonePros® TP6 bridge.				

**PS-8615**  
**\$39.95**

Tune-o-matic Saddles				
6 pieces Fits many Epiphone® style tune-o-matics with SUNG IL, B2, BH-1993 or Jin-Ah stamped on the underside of the bridge.				

**PS-8304**  
**\$54.95**

4 String Bass Saddle				
Precision® style bass saddles. Also fits Jazz® bass.				
LENGTH	THICKNESS	HEIGHT	E TO E	
Inches	0.747	0.335	0.335	2.076
Inches Approx.	3/4	11/32	11/32	2 1/16
Millimetres	18.97	8.51	8.51	52.73

**PS-8305**  
**\$68.70**

5 String Bass Saddle				
Precision® style bass saddles. Also fits Jazz® bass.				
LENGTH	THICKNESS	HEIGHT	E TO E	
Inches	0.747	0.335	0.335	2.234
Inches Approx.	3/4	11/32	11/32	2 7/32
Millimetres	18.97	8.51	8.51	63.50

**PS-8315**  
**\$68.70**

5 String Bass Precision®/Jazz® Style Saddle				
Precision® style bass saddles. Also fits Jazz® bass.				
LENGTH	THICKNESS	HEIGHT	E TO E	
Inches	0.603	0.343	0.337	2.500
Inches Approx.	19/32	11/32	11/32	2 1/2
Millimetres	15.33	8.71	8.55	69.5

**PS-8316**  
**\$82.45**

6 String Bass Precision®/Jazz® Style Saddle				
Narrow Precision® style bass saddles. Also fits Jazz® bass.				
LENGTH	THICKNESS	HEIGHT	E TO E	
Inches	0.604	0.343	0.337	3.000
Inches Approx.	19/32	11/32	11/32	3
Millimetres	15.34	8.71	8.56	76.2

**PS-8616**  
**\$39.95**

Tune-o-matic Saddles				
6 pieces Fits many tune-o-matics with SUNG IL, BM002, or AVR I stamped on the underside of the bridge.				

**PS-8633**  
**\$39.95**

Tune-o-matic Saddles				
6 pieces Fits many Epiphone® style tune-o-matics with SUNG IL, B-2 stamped on the underside of the bridge.				

### How do I choose the correct saddles?

When it comes to finding out what saddles will fit your tune-o-matic bridge, it can be a difficult process. The best thing you can do is check for any markings on the underside of your current bridge. With those markings check our fit chart below to see if we have a match.

BRIDGE STAMP	STRING SAVER PART	MSRP	BRIDGE STAMP	STRING SAVER PART	MSRP
B-2 orBH	PS-8616-00	\$39.95	Jin Ah ®	PS-8440-00	\$39.95
Gibson® ABR-01	PS-8400-00	\$39.95	Komax ®	PS-8615-00	\$39.95
Gibson® Nashville TOM pre 2000	PS-8500-00	\$39.95	Pigtail ® Wraparound	PS-8617-00	\$39.95
Gibson® Nashville TOM post 2000	PS-8501-00	\$39.95	PW	PS-8501-00	\$39.95
GOTOH ® Japan	PS-8560-00	\$39.95	S.I.C.	PS-8615-00	\$39.95
Hipshot® Baby Grand	PS-8616-00	\$39.95	TonePros® AVR-II	PS-8615-00	\$39.95
Schaller® 455 / 456	PS-8500-00	\$39.95	TonePros® AVT-II	PS-8501-00	\$39.95
Schaller® made in Germany	PS-8500-00	\$39.95	TonePros® GOTOH	PS-8600-00	\$39.95
SUNG IL®	PS-8616-00	\$39.95	TonePros® TP6	PS-8501-00	\$39.95
SUNG IL® BM002	PS-8615-00	\$39.95	TonePros® TPF6	PS-8502-00	\$39.95
SUNG IL® BM003	PS-8618-00	\$39.95	TonePros® T3BT	PS-8560-00	\$39.95
BR-EG	PS-8633-00	\$39.95	TonePros®	PS-8560-00	\$39.95
Epiphone ®	PS-8440-00	\$39.95	ResoMax Tune-o-matic Bridges	PS-8501-00	\$39.95

# GRAPH TECH®

PS-8593  
\$39.95

6 pieces  
Fits many PRS® style tune-o-matics.  
Also fits ResoMax NW bridges.

PS-8440  
\$39.95

6 pieces  
Fits many Badass® and newer Epiphone® style tune-o-matics.

PS-8617  
\$39.95

6 pieces  
Fits many TonePro® AVT-II style tune-o-matic bridges with AVT-II stamped on the underside of the bridge.  
Also fits Pignall® wrap around bridges.

PG-8000  
\$79.95

Import Strat® & Tele® Style Stainless Steel Saddle 6 pieces  
Fits most import Strat® style.

	LENGTH	THICKNESS	HEIGHT	E TO E
Inches	0.826	0.410	0.212	2.760
Inches Approx.	13/16	13/32	7/32	2 1/16
Millimetres	20.94	10.41	5.38	52.73

PG-8000-0B  
\$79.95

Import Strat® & Tele® Style Black Saddle 6 pieces  
Fits most import Strat® style.

	LENGTH	THICKNESS	HEIGHT	E TO E
Inches	0.826	0.410	0.212	2.760
Inches Approx.	13/16	13/32	7/32	2 1/16
Millimetres	20.94	10.41	5.38	52.73

PG-8000-0C  
\$79.95

Import Strat® & Tele® Style Chrome Saddle 6 pieces  
Fits most import Strat® style.

	LENGTH	THICKNESS	HEIGHT	E TO E
Inches	0.826	0.410	0.212	2.760
Inches Approx.	13/16	13/32	7/32	2 1/16
Millimetres	20.94	10.41	5.38	52.73

PG-8000-0G  
\$85.95

Import Strat® & Tele® Style Gold Saddle 6 pieces  
Fits most import Strat® style.

	LENGTH	THICKNESS	HEIGHT	E TO E
Inches	0.826	0.410	0.212	2.760
Inches Approx.	13/16	13/32	7/32	2 1/16
Millimetres	20.94	10.41	5.38	52.73

PG-8000-F0  
\$79.95

Vintage Strat® & Tele® Style Stainless Steel Saddle 6 pieces  
Fits most American Strat® & Squire® styles, 1950-1980

	LENGTH	THICKNESS	HEIGHT	E TO E
Inches	0.820	0.440	0.290	2.179
Inches Approx.	13/16	7/16	7/32	2 3/16
Millimetres	20.83	11.18	5.38	55.35

PG-8000-FC  
\$79.95

Vintage Strat® & Tele® Style Chrome Saddle 6 pieces  
Fits most American Strat® & Squire® styles, 1950-1980.

	LENGTH	THICKNESS	HEIGHT	E TO E
Inches	0.820	0.440	0.290	2.179
Inches Approx.	13/16	7/16	7/32	2 3/16
Millimetres	20.83	11.18	5.38	55.35

PG-8000-FG  
\$85.95

Vintage Strat® & Tele® Style Gold Saddle 6 pieces  
Fits most American Strat® & Squire® styles, 1950-1980

	LENGTH	THICKNESS	HEIGHT	E TO E
Inches	0.826	0.410	0.290	2.760
Inches Approx.	13/16	13/32	7/32	2 1/16
Millimetres	20.94	10.41	5.38	52.73

PG-8001  
\$79.95

Strat® & Tele® Style Offset Stainless Steel Saddle 6 pieces  
Fits most American Strat® Plus, Ultra & Standard® styles. Offset screw

	LENGTH	THICKNESS	HEIGHT	E TO E
Inches	0.826	0.410	0.212	2.760
Inches Approx.	13/16	13/32	7/32	2 1/16
Millimetres	20.94	10.41	5.38	52.73

PG-8001-DC  
\$79.95

Strat® & Tele® Style Offset Chrome Saddle 6 pieces  
Fits most American Strat® Plus, Ultra & Standard® styles. Offset screw

	LENGTH	THICKNESS	HEIGHT	E TO E
Inches	0.815	0.410	0.290	2.076
Inches Approx.	13/16	13/32	7/32	2 1/16
Millimetres	20.70	10.41	5.84	52.73

Floyd Rose® Saddles  
Fits most Floyd Rose® style guitars

ITEM NUMBER	COLOR	NUMBER OF SADDLES	MSRP
PG-0080-B6	BLACK	6	\$114.95
PG-0080-B7	BLACK	7	\$134.95
PG-0080-C6	CHROME	6	\$99.95
PG-0080-C7	CHROME	7	\$114.95
PG-0080-G6	GOLD	6	\$114.95
PG-0080-G7	GOLD	7	\$134.95

LB63 Locking Bridge  
The LB63 Bridge with String Saver saddles is a drop-in replacement for Floyd Rose® Original and Licensed bridges. Saddles are equipped with a String Saver insert that will dramatically reduce string breakage.

The LB63 Bridge is an unbeatable combination of materials that will improve your guitar's tone and performance.

ITEM NUMBER	COLOR	MSRP
PS-0080-B0	BLACK	\$255.00
PS-0080-C0	CHROME	\$239.95
PS-0080-G0	GOLD	\$255.00

## I.G. (Hardware, Capos, and Bridges)





**ResoMax Bridges maximize richness and will leave every note dripping in tone and harmonics**

The entire ResoMax line of bridges and tailpieces are made from our highly resonant alloy that is both strong and super lightweight. Resomax bridges deliver increased harmonic content and superior vibration transfer. Our patented Auto-Lock™ magnetically locks your bridge and tail piece with or without strings. With no tools to use or lose, restringing becomes simple and quick. Hear that vintage tone you've been missing.

ResoMax NVS  
4mm

ResoMax NVS Tune-O-Matic Bridge 4mm Loaded With U.L.F. Saddles.

ITEM NUMBER	COLOR	MSRP
PSJ-8843-BN	BLACK NICKEL	\$119.95
PSJ-8843-C0	CHROME	\$113.95
PSJ-8843-G0	GOLD	\$119.95
PSJ-8843-N0	NICKEL	\$113.95

ResoMax NV2  
4mm

ResoMax NV2 Tune-O-Matic Bridge 4mm Loaded With String Saver Saddles.

ITEM NUMBER	COLOR	MSRP
PS-8843-BN	BLACK NICKEL	\$99.95
PS-8843-C0	CHROME	\$94.95
PS-8843-G0	GOLD	\$99.95
PS-8843-N0	NICKEL	\$94.95

ResoMax NW2

ResoMax NW2 Wraparound Magnetic Bridge Loaded With ResoMax Saddles.

ITEM NUMBER	COLOR	MSRP
PS-8593-BN	BLACK NICKEL	\$169.95
PS-8593-C0	CHROME	\$149.95
PS-8593-G0	GOLD	\$169.95
PS-8593-N0	NICKEL	\$149.95

ResoMax NVS  
6mm

ResoMax NVS Tune-O-Matic Bridge 6mm Loaded With U.L.F. Saddles.

ITEM NUMBER	COLOR	MSRP
PSJ-8863-BN	BLACK NICKEL	\$119.95
PSJ-8863-C0	CHROME	\$113.95
PSJ-8863-G0	GOLD	\$119.95
PSJ-8863-N0	NICKEL	\$113.95

ResoMax NV2  
6mm

ResoMax NV2 Tune-O-Matic Magnetic Bridge 6mm Loaded With String Saver Saddles.

ITEM NUMBER	COLOR	MSRP
PS-8863-BN	BLACK NICKEL	\$99.95
PS-8863-C0	CHROME	\$94.95
PS-8863-G0	GOLD	\$99.95
PS-8863-N0	NICKEL	\$94.95

ResoMax NV1  
4mm

ResoMax NV1 Tune-O-Matic Bridge 4mm Loaded With ResoMax Saddles.

ITEM NUMBER	COLOR	MSRP
PM-8843-BN	BLACK NICKEL	\$99.95
PM-8843-C0	CHROME	\$94.95
PM-8843-G0	GOLD	\$99.95
PM-8843-N0	NICKEL	\$94.95

ResoMax NVT

ResoMax NVT Tune-O-Matic Magnetic Tailpiece

ITEM NUMBER	COLOR	MSRP
PS-8893-BN	BLACK NICKEL	\$69.95
PS-8893-C0	CHROME	\$64.95
PS-8893-G0	GOLD	\$69.95
PS-8893-N0	NICKEL	\$64.95

ResoMax NV1  
6mm

ResoMax NV1 Tune-O-Matic Bridge 6mm Loaded With ResoMax Saddles.

ITEM NUMBER	COLOR	MSRP
PM-8863-BN	BLACK NICKEL	\$99.95
PM-8863-C0	CHROME	\$94.95
PM-8863-G0	GOLD	\$99.95
PM-8863-N0	NICKEL	\$94.95

ResoMax NW1

ResoMax NW1 Wraparound Magnetic Bridge Loaded With ResoMax Saddles.

ITEM NUMBER	COLOR	MSRP
PM-8593-BN	BLACK NICKEL	\$169.95
PM-8593-C0	CHROME	\$149.95
PM-8593-G0	GOLD	\$169.95
PM-8593-N0	NICKEL	\$149.95

# GRAPH TECH®

## III. F. (Pickups)

# ghost

modular pickup systems

Incredibly authentic tone - Easy, clean, hidden installation.

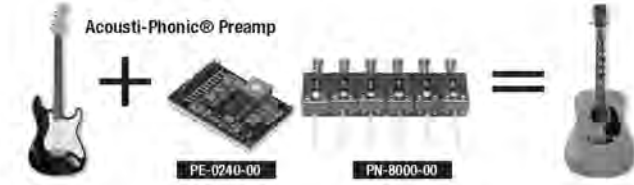

**ghost® Acousti-Phonic-Studio-quality acoustic tone, from your electric or bass guitar.**

Authentic acoustic guitar tone coming from your electric guitar - at the flick of a switch! Replace your current saddles with Graph Tech's ghost® loaded saddles and Acousti-Phonic® preamp and you'll have instant access to true, acoustic tone from your electric or bass guitar, without altering your electric pickups.

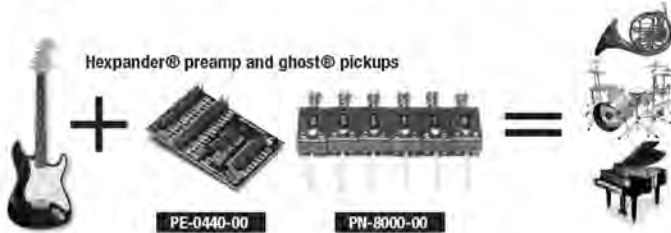

**ghost® Hexpander**

The ghost® Hexpander MIDI Interface System adds MIDI capability to almost any guitar or bass. Plug your guitar into pitch-to-MIDI converters and enter the midi sound universe. The Hexpander MIDI Interface provides responsive and accurate tracking unequalled by any other system on the market today.

**PN-8000**  
**\$124.95B**

Import Strat® & Tele® Style Piezo Saddle				
Fits most Import Strat® style. Fits American Strat® style with slight gap				
	LENGTH	THICKNESS	HEIGHT	E TO E
Inches	0.815	0.410	0.230	2.760
Inches Approx.	13/16	13/32	7/32	2 1/16
Millimetres	20.70	10.41	5.84	32.73

**PN-8000-F0**  
**\$124.95B**

Vintage Strat® & Tele® Style Saddle				
Fits most vintage and vintage re-issue Strat® and Tele® styles				
	LENGTH	THICKNESS	HEIGHT	E TO E
Inches	0.820	0.440	0.230	2.179
Inches Approx.	13/16	7/16	7/32	2 3/16
Millimetres	20.83	11.18	5.84	55.25

**PN-8001**  
**\$124.95B**

Offset Strat® & Tele® Style Saddle				
Fits Strat® and Tele® styles with an offset intonation screw				
	LENGTH	THICKNESS	HEIGHT	E TO E
Inches	0.815	0.410	0.230	2.075
Inches Approx.	13/16	13/32	7/32	2 1/16
Millimetres	20.70	10.41	5.84	32.73

**PN-8220**  
**\$124.95B**

PRS® (Paul Reed Smith) Style Piezo Saddle				
Fits many PRS® style guitars. Slightly lower than our PN-8000-00				
	LENGTH	THICKNESS	HEIGHT	E TO E
Inches	0.815	0.410	0.230	2.075
Inches Approx.	13/16	13/32	7/32	2 1/16
Millimetres	20.70	10.41	5.84	32.73

**PN-8200**  
**\$124.95B**

Wilkinson® Style Piezo Saddle				
Set contains 3 different height saddles. Measure for highest saddle				
	LENGTH	THICKNESS	HEIGHT	E TO E
Inches	1.200	0.500	0.250	VARIABLE
Inches Approx.	1 1/4	5/8	1/4	VARIABLE
Millimetres	31.75	9.91	6.35	VARIABLE

**PN-8163**  
**\$149.95B**

I.O.S. Tele® Style Barrel Saddle				
Increased Oscillation & Sustain. Features accurate intonation points				
	LENGTH	THICKNESS	HEIGHT	E TO E
Inches	0.411	0.400	0.271	2.187
Inches Approx.	33/64	5/16	17/64	2 3/16
Millimetres	21.66	7.62	6.60	55.25

**ghost LB63**

**ghost LB63 Locking Bridge**  
The ghost LB63 Bridge is a drop-in replacement for Floyd Rose Original and Licensed bridges. It comes loaded with ghost acoustic pickups encased in our own String Grabber™ pickup inserts, loaded into metal saddles.

ghost LB63 Bridge comes with:

- bridge with metal saddles & pickup inserts
- 6 bars
- summing board
- dual connector caps
- tremolo arm
- tremolo springs
- allen keys
- screws
- claw

ITEM NUMBER	COLOR	MSRP
<b>PN-0080-B0</b>	<b>BLACK</b>	<b>\$315.00B</b>
<b>PN-0080-C0</b>	<b>CHROME</b>	<b>\$299.95B</b>
<b>PN-0080-G0</b>	<b>GOLD</b>	<b>\$315.00B</b>

**ghost**  
**ResoMax NV**  
**4mm**

ResoMax Tune-O-Matic Bridge 4mm Loaded With ghost Piezo Saddles			
ITEM NUMBER	COLOR	MSRP	
<b>PN-8843-BN</b>	<b>BLACK NICKEL</b>	<b>\$199.95B</b>	
<b>PN-8843-C0</b>	<b>CHROME</b>	<b>\$193.95B</b>	
<b>PN-8843-G0</b>	<b>GOLD</b>	<b>\$199.95B</b>	
<b>PN-8843-N0</b>	<b>NICKEL</b>	<b>\$193.95B</b>	

**ghost**  
**ResoMax NV**  
**6mm**

ResoMax Tune-O-Matic Bridge 6mm Loaded With ghost Piezo Saddles			
ITEM NUMBER	COLOR	MSRP	
<b>PN-8863-BN</b>	<b>BLACK NICKEL</b>	<b>\$199.95B</b>	
<b>PN-8863-C0</b>	<b>CHROME</b>	<b>\$193.95B</b>	
<b>PN-8863-G0</b>	<b>GOLD</b>	<b>\$199.95B</b>	
<b>PN-8863-N0</b>	<b>NICKEL</b>	<b>\$193.95B</b>	

**ghost**  
**ResoMax**  
**Wrap**

ResoMax NW2 Wraparound Bridge Loaded With ghost Piezo Saddles			
ITEM NUMBER	COLOR	MSRP	
<b>PN-8593-BN</b>	<b>BLACK NICKEL</b>	<b>\$269.95B</b>	
<b>PN-8593-C0</b>	<b>CHROME</b>	<b>\$249.95B</b>	
<b>PN-8593-G0</b>	<b>GOLD</b>	<b>\$269.95B</b>	
<b>PN-8593-N0</b>	<b>NICKEL</b>	<b>\$249.95B</b>	

**PE-0240**  
**\$79.95B**

**ghost Acousti-Phonic for Guitar**  
Pick ups not included

- BD-0240-00 Acousti-Phonic Intelligent pre-amp EQ'd
- BD-0103-01 Switchcraft Stereo Switched Output Jack
- BD-5003-00 Stereo Output Jack Cable Assembly (R-W-Bu harness, connects jack to pre-amp)
- BD-5002-00 Acoustic Volume Cable Assembly (Vi-Y-Gn harness, connects volume pot and mag system to pre-amp)
- BD-0204-00 Battery Connector (connects 9v to pre-amp)
- BD-0205-00 Battery Holder (metal clip that holds 9V battery)

**PE-0340**  
**\$79.95B**

**ghost Acousti-Phonic for Bass**  
Pick ups not included

- BD-0340-00 Acousti-Phonic Intelligent pre-amp EQ'd
- BD-0103-01 Switchcraft Stereo Switched Output Jack
- BD-5003-00 Stereo Output Jack Cable Assembly (R-W-Bu harness, connects jack to pre-amp)
- BD-5002-00 Acoustic Volume Cable Assembly (Vi-Y-Gn harness, connects volume pot and mag system to pre-amp)
- BD-0204-00 Battery Connector (connects 9v to pre-amp)
- BD-0205-00 Battery Holder (metal clip that holds 9V battery)

**PK-0240**  
**\$149.95B**

**ghost Acousti-Phonic Kit for Guitar**  
Includes additional options. Pick ups not included

- BD-0240-00 Acousti-Phonic Intelligent pre-amp EQ'd PLUS:
- BD-0103-01 Switchcraft Stereo Switched Output Jack
- BD-5003-00 Stereo Output Jack Cable Assembly (R-W-Bu harness, connects jack to pre-amp)
- BD-5002-00 Acoustic Volume Cable Assembly (Vi-Y-Gn harness, connects volume pot and mag system to pre-amp)
- BD-0204-00 Battery Connector (connects 9v to pre-amp)
- BD-0205-00 Battery Holder (metal clip that holds 9V battery)
- PE-0111-00 QuickSwitch for mag/both/acoustic
- PE-0206-00 Acoustic Volume Pot with Mid/Dark Switch

**PK-0340**  
**\$79.95B**

**ghost Acousti-Phonic Kit for Bass**  
Includes additional options. Pick ups not included

- BD-0340-00 Acousti-Phonic Intelligent pre-amp EQ'd PLUS:
- BD-0103-01 Switchcraft Stereo Switched Output Jack
- BD-5003-00 Stereo Output Jack Cable Assembly (R-W-Bu harness, connects jack to pre-amp)
- BD-5002-00 Acoustic Volume Cable Assembly (Vi-Y-Gn harness, connects volume pot and mag system to pre-amp)
- BD-0204-00 Battery Connector (connects 9v to pre-amp)
- BD-0205-00 Battery Holder (metal clip that holds 9V battery)
- PE-0111-00 QuickSwitch for mag/both/acoustic
- PE-0206-00 Acoustic Volume Pot with Mid/Dark Switch

### ADDITIONAL OPTIONS

**PE-0111**  
**\$28.95B**



Quick Switch

**PE-0206**  
**\$52.35B**



Acoustic Volume Pot with Mid/Dark Switch

**PE-0180**  
**\$34.95B**



Program Up/Down Switch

**PE-0181**  
**\$28.95B**



Hexpander MIDI Volume Pot

# GRAPH TECH®

## ghost® Hexpander Ordering Guide

PE-0440  
\$189.95B

ghost Hexpander MIDI Interface for Guitar and Bass  
Pick ups not included

- BD-0440-00 Hexpander MIDI interface
- BD-0540-00 13-pin Output Jack
- BD-0515-00 13-pin Mounting Plate
- BD-0512-00 Interface Wiring Harness
- BD-0511-00 Extension Wiring Harness

## ghost® Hexpander Kit - includes additional options

PK-0440  
\$269.95B

ghost Hexpander MIDI Interface Kit for Guitar and Bass  
includes additional options Pick ups not included

- BD-0440-00 Hexpander MIDI interface
- BD-0540-00 13-pin Output Jack
- BD-0515-00 13-pin Mounting Plate
- BD-0512-00 Interface Wiring Harness
- BD-0511-00 Extension Wiring Harness
- PE-0111-00 QuickSwitch for MIDI/both/guitar
- PE-0111-00 QuickSwitch for mag/both/acoustic
- PE-0180-00 Program up/down switch
- PE-0181-00 Hexpander MIDI volume pot

PK-0680  
\$419.95B

ghost Complete Kit for Guitar  
Pick ups not included

- BD-0440-00 Hexpander MIDI Interface
- BD-0111-00 QuickSwitch for MIDI/both/mag+ acoustic
- BD-0181-00 Hexpander Volume Pot
- BD-0180-00 Program Up/Down switch
- BD-0240-00 Acousti-Phonic EQ'd for Guitar
- BD-0206-00 Acoustic Volume with Mid/Dark Switch
- BD-0111-00 QuickSwitch for mag/both/acoustic
- BE-0540-00 Output Jack with Traktion Switch

PK-7077  
\$349.95B

ghost Acoustic MIDI System for Nylon String Guitars

- BN-9277-RU 6 ghost loaded pickups for nylon string
- BD-5100-00 ghost battery jack assembly
- BD-0077-00 ghost acoustic tone control board
- BD-0477-00 ghost acoustic Hex preamp board
- BD-0512-12 Hexpander interface wiring harness
- BS-0077-00 Pagoda shim
- BD-0205-00 battery holder

PK-0780  
\$419.95B

ghost Complete Kit for Bass  
Pick ups not included

- BD-0440-00 Hexpander MIDI Interface
- BD-0111-00 QuickSwitch for MIDI/both/mag+acoustic
- BD-0181-00 Hexpander Volume Pot
- BD-0180-00 Program Up/Down switch
- BD-0340-00 Acousti-Phonic for EQ'd Bass
- BD-0206-00 Acoustic Volume with Mid/Dark Switch
- BD-0111-00 QuickSwitch for mag/both/acoustic
- BE-0540-00 Output Jack with Traktion Switch

PK-8077  
\$349.95B

ghost Acoustic MIDI System for Steel String Guitars

- BN-9277-RU 3 ghost loaded pickups for steel string
- BN-9286-RU 3 ghost loaded pickups for steel string
- BD-5100-00 ghost battery jack assembly
- BD-0077-00 ghost acoustic tone control board
- BD-0477-00 ghost acoustic Hex preamp board
- BD-0512-12 Hexpander interface wiring harness
- BS-0077-00 Pagoda shim
- BD-0205-00 battery holder

## I.I. (Tuning Machines and Pegs)

**RAT:O**  
TUNED MACHINE HEADS



### Simply, the best tuning system for stringed instruments... ever.

The simple genius of Ratio. By matching the machine head gear ratios to the specific strings, all strings now respond equally to any tuning adjustment. No more overshooting the G string or twisting away on the high E - just quicker tuning, re-tuning and open tuning on the fly. Ratio tuning feels so natural you don't have to think about which string you are tuning because they all tune the same. Triple plated finishes and hardened steel gears ensure years and years of precision tuning. Ratio - the new standard in tuning.

Product Code	Description	MSRP
PRN-2311-CO	Ratio Electric 3+3 Right Handed Contemporary 2 Pin - Chrome	\$99.99
PRN-2311-GO	Ratio Electric 3+3 Right Handed Contemporary 2 Pin - Gold	\$109.99
PRN-2311-NO	Ratio Electric 3+3 Right Handed Contemporary 2 Pin - Nickel	\$99.99
PRN-2311-BO	Ratio Electric 3+3 Right Handed Contemporary 2 Pin - Black	\$99.99
PRN-4311-CO	Ratio Electric 3+3 Right Handed Contemporary Offset Screw - Chrome	\$99.99
PRN-4311-GO	Ratio Electric 3+3 Right Handed Contemporary Offset Screw - Gold	\$109.99
PRN-4311-NO	Ratio Electric 3+3 Right Handed Contemporary Offset Screw - Nickel	\$99.99
PRN-4311-BO	Ratio Electric 3+3 Right Handed Contemporary Offset Screw - Black	\$99.99
PRN-2411-CO	Ratio Acoustic 3+3 Right Handed Contemporary 2 Pin - Chrome	\$99.99
PRN-2411-GO	Ratio Acoustic 3+3 Right Handed Contemporary 2 Pin - Gold	\$109.99
PRN-2411-NO	Ratio Acoustic 3+3 Right Handed Contemporary 2 Pin - Nickel	\$99.99
PRN-2411-BO	Ratio Acoustic 3+3 Right Handed Contemporary 2 Pin - Black	\$99.99
PRN-4411-CO	Ratio Acoustic 3+3 Right Handed Contemporary Offset Screw - Chrome	\$99.99
PRN-4411-GO	Ratio Acoustic 3+3 Right Handed Contemporary Offset Screw - Gold	\$109.99
PRN-4411-NO	Ratio Acoustic 3+3 Right Handed Contemporary Offset Screw - Nickel	\$99.99
PRN-4411-BO	Ratio Acoustic 3+3 Right Handed Contemporary Offset Screw - Black	\$99.99

Product Code	Description	MSRP
PRN-2721-CO	Ratio Electric 6 Inline Right Handed Mini Contemporary 2 Pin - Chrome	\$99.99
PRN-2721-GO	Ratio Electric 6 Inline Right Handed Mini Contemporary 2 Pin - Gold	\$109.99
PRN-2721-NO	Ratio Electric 6 Inline Right Handed Mini Contemporary 2 Pin - Nickel	\$99.99
PRN-2721-BO	Ratio Electric 6 Inline Right Handed Mini Contemporary 2 Pin - Black	\$99.99
PRN-4721-CO	Ratio Electric 6 Inline Right Handed Mini Contemporary Offset Screw - Chrome	\$99.99
PRN-4721-GO	Ratio Electric 6 Inline Right Handed Mini Contemporary Offset Screw - Gold	\$109.99
PRN-4721-NO	Ratio Electric 6 Inline Right Handed Mini Contemporary Offset Screw - Nickel	\$99.99
PRN-4721-BO	Ratio Electric 6 Inline Right Handed Mini Contemporary Offset Screw - Black	\$99.99
PRN-2731-CO	Ratio Electric 6 Inline Right Handed Classic 2 Pin - Chrome	\$99.99
PRN-2731-GO	Ratio Electric 6 Inline Right Handed Classic 2 Pin - Gold	\$109.99
PRN-2731-NO	Ratio Electric 6 Inline Right Handed Classic 2 Pin - Nickel	\$99.99
PRN-2731-BO	Ratio Electric 6 Inline Right Handed Classic 2 Pin - Black	\$99.99
PRN-4731-CO	Ratio Electric 6 Inline Right Handed Classic Offset Screw - Chrome	\$99.99
PRN-4731-GO	Ratio Electric 6 Inline Right Handed Classic Offset Screw - Gold	\$109.99
PRN-4731-NO	Ratio Electric 6 Inline Right Handed Classic Offset Screw - Nickel	\$99.99
PRN-4731-BO	Ratio Electric 6 Inline Right Handed Classic Offset Screw - Black	\$99.99

# DiMARZIO PARTS



## PARTS FOR GIBSON GUITAR

<b>GG1000GR</b>	Guitar Nut, graphite .....	<b>\$ 6.95</b>
<b>GG1400BK</b>	Jackplate, Black.....	<b>14.25</b>
<b>GG1400C</b>	Jackplate, Chrome .....	<b>9.75</b>
<b>GG1400G</b>	Jackplate, Gold .....	<b>11.50</b>
<b>GG1602C</b>	Chrome Humbucking Cover, with DiMarzio Sunburst Logo .....	<b>10.50</b>
<b>GG1600BK</b>	PAF Cover, Black Metal.....	<b>15.50</b>
<b>GG1601BK</b>	PAF Cover, Black Metal F Space .....	<b>15.50</b>
<b>PCVN</b>	Nickel Pickup Cover .....	<b>13.50</b>
<b>PCVB</b>	Black Pickup Cover .....	<b>15.00</b>
<b>PCVG</b>	Gold Pickup Cover.....	<b>15.00</b>
<b>GH1000C</b>	Pickguard and Backplate Screws (24).....	<b>5.95</b>
<b>GH1000BK</b>	Pickguard and Backplate Screws (24), Black .....	<b>6.50</b>
<b>GH1000G</b>	Pickguard and Backplate Screws (24), Gold.....	<b>12.00</b>
<b>GH1200C</b>	Humbucking Mounting Hardware Kit, neck position.....	<b>3.45</b>
<b>GH1200BK</b>	Humbucking Mounting Hardware Kit, neck position, Black .....	<b>3.95</b>
<b>GH1200G</b>	Humbucking Mounting Hardware Kit, neck position, Gold .....	<b>5.55</b>
<b>GH1201C</b>	Humbucking Mounting Hardware Kit, bridge position .....	<b>4.05</b>
<b>GH1201BK</b>	Humbucking Mounting Hardware Kit, bridge position, Black .....	<b>4.50</b>
<b>GH1201G</b>	Humbucking Mounting Hardware Kit, bridge position, Gold .....	<b>6.00</b>

## PARTS FOR STRATOCASTER & TELECASTER

<b>FG1000GR</b>	Guitar Nut, graphite .....	<b>\$ 6.95</b>
<b>FG1000P</b>	Guitar Nut, plastic.....	<b>2.95</b>
<b>FG1101C</b>	Vintage Strap Buttons, Chrome (2) .....	<b>5.55</b>
<b>FG1800G</b>	Brass Strat Replacement Jackplate, recessed .....	<b>12.50</b>
<b>FG1800BK</b>	Brass Strat Replacement Jackplate, recessed, Black .....	<b>7.25</b>
<b>FG1800C</b>	Brass Strat Replacement Jackplate, recessed, Chrome .....	<b>9.95</b>

## HARDWARE FOR FENDER

<b>FH1000C</b>	Pickguard and Backplate Screws (24), Chrome .....	<b>\$ 8.00</b>
<b>FH1000BK</b>	Same FG1000C but Black .....	<b>8.50</b>
<b>FH1000G</b>	Same FG1000C but Gold .....	<b>15.00</b>
<b>FH1100</b>	Neck Plate Screws (4), Chrome .....	<b>3.00</b>
<b>FH1300</b>	Height Adjustment Screws (6) for Strat or Tele Pickups.....	<b>3.00</b>
<b>FH1300BK</b>	Same FH1300 but Black .....	<b>4.50</b>
<b>FH1301</b>	Vintage Style Countersunk Height Adjustment Screws (6) for Strat Pickups, Chrome .....	<b>4.05</b>
<b>FH1301BK</b>	Vintage Style Countersunk Height Adjustment Screws (6) for Strat Pickups, Black .....	<b>4.50</b>
<b>FH1400</b>	Bridge Hardware Kit (height and intonation screws, springs and wrench) .....	<b>7.25</b>
<b>FH1500</b>	Bass Pickup Height Adjustment Screws (8), Chrome .....	<b>4.00</b>
<b>FH1500BK</b>	Same FH1500 but Black .....	<b>4.00</b>
<b>FH1500G</b>	Same FH1500 but Gold .....	<b>6.00</b>
<b>FH1701</b>	Tremolo Bridge Springs (5) .....	<b>12.50</b>
<b>FH1800C</b>	Bridge Mounting Screws (6) for Bass, Non-Trem Strat, Tele, Chrome .....	<b>2.00</b>
<b>FH1800BK</b>	Same FH1800 but Black .....	<b>2.50</b>
<b>FH1900C</b>	Tremolo Bridge or Strap Button Mounting Screws (6), hardened, Chrome.....	<b>3.00</b>
<b>FH1900BK</b>	Same FH1900 but Black .....	<b>4.00</b>

## MISCELLANEOUS ELECTRICAL PARTS

<b>EP1000</b>	Copper Shielding Tape (24" x 3½", self-adhesive) .....	<b>\$13.95</b>
<b>EP1001</b>	Capacitor, .001 microfarad .....	<b>1.75</b>
<b>EP1022</b>	Capacitor, .022 microfarad .....	<b>1.75</b>
<b>EP1033</b>	Capacitor, .033 microfarad .....	<b>1.75</b>
<b>EP1047</b>	Capacitor, .047 microfarad .....	<b>1.75</b>
<b>EP1050</b>	Capacitor, .1 microfarad .....	<b>2.25</b>
<b>EP1100</b>	Toggle Switch, right-angle (includes knob & nut) .....	<b>16.95</b>
<b>EP1101</b>	Straight, Gibson Toggle Switch Long .....	<b>28.95</b>
<b>EP1104</b>	Five Way Switch, Strat replacement (includes knob & screws) .....	<b>13.00</b>
<b>EP1105</b>	Three Way Switch, Tele replacement (includes knob & screws) .....	<b>15.00</b>
<b>EP1106</b>	DPDT Mini Switch, Two-Position .....	<b>8.50</b>
<b>EP1107</b>	DPDT Mini Switch, Three-Position (on-off-on) .....	<b>13.95</b>
<b>EP1108</b>	DPDT Mini Switch, Three-aPosition (on-on-on).....	<b>14.25</b>
<b>EP1112</b>	Five Way Switch, MultiPole (includes knob & screws).....	<b>39.95</b>
<b>EP1200</b>	DiMarzio Custom Taper Potentiometer, 250K .....	<b>9.00</b>
<b>EP1200PP</b>	Push/Pull Potentiometer (DPDT switch), 250K .....	<b>15.00</b>
<b>EP1201PP</b>	Push/Pull Potentiometer (DPDT switch), 500K .....	<b>15.00</b>
<b>EP1201</b>	Custom Taper Potentiometer ,500K.....	<b>9.00</b>
<b>EP1201L</b>	500K, Long Shaft, Pot .....	<b>11.50</b>
<b>EP1202</b>	1 Meg Potentiometer .....	<b>14.25</b>
<b>EP2300</b>	300K Resistor.....	<b>1.25</b>
<b>EP1300</b>	Acoustic Guitar End Pin Replacement Jack .....	<b>19.95</b>
<b>EP1301</b>	Switchcraft Output Jack, 2 conductor .....	<b>6.00</b>

## MISCELLANEOUS HARDWARE

<b>DM1000C</b>	Tuning Peg Mounting Screws (16), Chrome.....	<b>\$ 5.75</b>
<b>DM1000BK</b>	Tuning Peg Mounting Screws (16), Black.....	<b>6.50</b>
<b>DM1000G</b>	Tuning Peg Mounting Screws (16), Gold .....	<b>8.50</b>
<b>DM1200BK</b>	Knob for Switchcraft Toggle Switch, Black .....	<b>3.95</b>
<b>DM1200CR</b>	Knob for Switchcraft Toggle Switch, Creme.....	<b>3.95</b>
<b>DM1300BK</b>	Mounting Ring, neck position, Black .....	<b>4.00</b>
<b>DM1300CR</b>	Mounting Ring, neck position, Creme .....	<b>4.00</b>
<b>DM1300W</b>	Mounting Ring, neck position, White .....	<b>5.00</b>
<b>DM1301BK</b>	Mounting Ring, bridge position, Black.....	<b>4.00</b>
<b>DM1301CR</b>	Mounting Ring, bridge position, Creme .....	<b>4.00</b>
<b>DM1301W</b>	Mounting Ring, bridge position, White .....	<b>5.00</b>
<b>DM2000BK</b>	Vintage Single Coil P/U Covers (3), Black .....	<b>9.95</b>
<b>DM2000W</b>	Vintage Single Coil P/U Covers (3), White.....	<b>9.95</b>
<b>DM2001</b>	Single Coil P/U Covers (3) Black, Creme, White .....	<b>9.95</b>
<b>DM2002BK</b>	Fast Track Covers (3) Black .....	<b>10.95</b>
<b>DM2100BK</b>	Speed Knob Black .....	<b>4.95</b>
<b>DM2100CR</b>	Speed Knob Creme .....	<b>4.95</b>
<b>DM2101BK</b>	Bell Knob, Black .....	<b>4.05</b>
<b>DM2108BK</b>	Switch Knob, Black (Button Style) .....	<b>2.70</b>
<b>DM2108CR</b>	Switch Knob, Creme (Button Style) .....	<b>2.70</b>
<b>DM2108W</b>	Switch Knob, white (Button Style) .....	<b>1.75</b>
<b>DM2110BK</b>	Brass Barrel Knob, Black .....	<b>13.50</b>
<b>DM2110C</b>	Brass Barrel Knob, Chrome.....	<b>10.50</b>
<b>DM2110G</b>	Brass Barrel Knob, Gold.....	<b>12.50</b>
<b>DM2111BK</b>	Replacement Knobs (1 volume, 2 tone), Black.....	<b>9.00</b>
<b>DM2111W</b>	Replacement Knobs (1 volume, 2 tone), White.....	<b>9.95</b>
<b>AW400</b>	Tremolo Arm Knob, White .....	<b>2.00</b>
<b>AB400</b>	Tremolo Arm Knob, Black .....	<b>2.00</b>
<b>DM2114</b>	Switch Knob, Black (Top Hat).....	<b>6.00</b>

www.dimarzio.com

"The products advertised on this page are manufactured by Di Marzio, which has no connection with Fender Musical Instruments Corporation. DiMarzio products are not approved or licensed by Fender Musical Instruments Corporation. Modification of Fender products may invalidate manufacturer's warranty."

PRICES SUBJECT TO CHANGE WITHOUT NOTICE

# Q-PARTS® AGED COLLECTIONS



## For Telecaster®

AG1158560	Tuners	'57 Kluson® Deluxe style tuner, 6-single vertical line, metal knobs, included bushings and screws.....	\$46.00B
AG2161660	String Retainers	Early 50's Tele® and Strap® replacement round string retainer .....	6.00B
AG1158760	Neck Plates	60's 4-mounting holes neck plate 0.08" (2mm) thickness .....	12.00B
AG2161860	Knobs	53 Tele® replacement half dome metal knob with slotted set screw, fitted for inch, metric and solid pot shafts.....	10.00B
AG1158960	Strap Buttons	STD Fender® replacement vintage strap button w/felt washer .....	4.00B
AG2162060	Control Plates	STD Tele® control plate, 3/8" (9.6mm) volume holes, 0.06" (1.5mm) thickness.....	8.00B
AG2162160	Bridges	'54 Tele® replacement bridge with solid brass saddles, 2 1/8" (54mm) string wide, 6-32 slotted saddle screws.....	44.00B
AG2162260	Bridges	'58 Tele® replacement bridge with threaded saddles, 2 1/8" (54mm) string wide, 6-32 slotted saddle screws.....	44.00B
AG2162360	String Ferrules	60's string ferrules set, 3/8" (10.00mm) flange, 5/16" (7.93mm) hole required, 6 pcs. a set.....	10.00B
AG2162400	Lever Switch Tip	Pickup selector tip, fitted for domestic and imported switches.....	1.50B
AG1159445	Nuts	Pre-made STD Strat® and Tele® replacement bone nut with oil treatment, 1.692" L (43mm) x 0.196" H (5mm) x 0.133" T (3.4mm).....	14.00B
AG1159560	Jack	STD 1/4" mono output jack, fits for the most guitars.....	4.00B
AG2162760	Jack Plates	Vintage Tele® replacement Jack Cup, with retainer clip, smooth edge and side.....	6.00B
AG2162860	Pickup Cover	Vintage Tele® replacement neck pickup (Rhythm) cover, nickel silver .....	16.00B
AG1160060	Pickguard Screws	4-13 inch threaded pickguard mounting screws, oval, phillips head, 12 pcs. a set.....	6.00B
AG2163360	Pickup Screws	6-32 inch threaded bridge pickup mounting screws, pan head, 3 pcs. a set.....	6.00B
AG2160960	Bridge Screws	Bridge mounting screws, oval head, 4 pcs. a set.....	6.00B
AG1160460	Switch Screws	6-32 inch threaded lever switch mounting screws, pan head, 2 pcs. a set.....	4.00B
AG1160560	Switch Screws	6-32 inch threaded lever switch mounting screws, oval, w/c-sink, 2 pcs. a set.....	4.00B
AG1160660	Control Plate Screws	Control plate mounting screws, oval head, 2 pcs. a set.....	4.00B
AG1160760	Strap Button Screws	Strap button screws, oval head, 2 pcs. a set.....	4.00B
AG1160860	Neck Screws	Neck plate mounting screws, oval head, 4 pcs. a set .....	6.00B

## For P-Bass®

AG6164060	Tuners	'59 P-Bass® open gear/long neck tuning gears, 4-single vertical line, includes bushings and screws .....	\$56.00B
AG6164160	String Retainers	Traditional Fender® P/J Bass® vintage replacement string retainer .....	3.00B
AG1158760	Neck Plates	60's 4-mounting holes neck plate 0.08" (2mm) thickness .....	12.00B
AG6164360	Knobs	50 P-Bass® metal flat knob with slotted set screw, fits for inch, metric and solid pot shafts.....	8.00B
AG1158960	Strap Buttons	STD Fender® replacement vintage strap button w/felt washer .....	4.00B
AG6164560	Bridges	'60 P/J Bass® bridge with threaded saddles, 6-32 slotted saddle screws .....	44.00B
AG6164645	Nuts	Pre-cut STD P-Bass replacement type bone nut with oil treatment, 1.637" L (41.6mm) x 0.208 H (5.3mm) x 0.133" T (3.4mm).....	4.00B
AG1159560	Jacks	STD 1/4" mono output jack, fits for the most guitars.....	4.00B
AG6164800	Thumb rest	'59 P-Bass® replacement plastic thumb rest .....	4.00B
AG1160060	Pickguard Screws	4-13 inch threaded pickguard mounting screws, oval, phillips head, 12 pcs. a set.....	6.00B
AG6165360	Pickup Screws	P/J Bass® pickup mounting screws, pan head, 4 pcs. a set .....	6.00B
AG6165460	Bridge Screws	Bridge mounting screws, oval head, 4 pcs. a set.....	6.00B
AG1160760	Strap Button Screws	Strap button mounting screws, oval head, 2 pcs. a set.....	4.00B
AG1160860	Neck Screws	Neck plate mounting screws, oval head, 4 pcs. a set .....	6.00B

## For Jazz Bass®

AG6164060	Tuners	'59 P-Bass® open gear/long neck tuning gear, 4-single vertical line, includes bushings and screws .....	\$56.00B
AG6164160	String Retainers	Traditional Fender® P/J Bass® vintage replacement string retainer .....	3.00B
AG1158760	Neck Plates	60's 4-mounting holes neck plate 0.08" (2mm) thickness .....	12.00B
AG7168660	Control Plates	Traditional Fender® J-Bass® replacement control plate, 3/8" (10mm) volume holes. Check your pots before buying .....	20.00B
AG7168700	Knobs	Traditional Fender® J-Bass® replacement Big knob for INCH pot (24 teeth) shafts only. Check your pots before buying.....	6.00B
AG7170600	Knobs	Traditional Fender® J-Bass® type Small knob for INCH pot (24 teeth) shafts only. Check your pots before buying.....	6.00B
AG1158960	Strap Buttons	STD Fender® style vintage strap button w/felt washer.....	4.00B
AG6164560	Bridges	'60 P/J bass bridge with threaded saddles, 6-32 slotted saddle screws .....	44.00B
AG7169045	Nuts	Pre-cut STD J-Bass® replacement bone nut with oil treatment, 1.507" L (383mm) x 0.236 H (6mm) x 0.133" T (3.4mm).....	14.00B
AG71159560	Jack	STD 1/4" mono output jack, fits for the most guitars.....	4.00B
AG1160060	Pickguard Screws	4-13 inch threaded pickguard mounting screws, oval, phillips head, 12 pcs. a set.....	6.00B
AG6165360	Pickup Screws	P/J Bass® pickup mounting screws, pan head, 4 pcs. a set .....	6.00B
AG6165460	Bridge Screws	Bridge mounting screws, oval head, 4 pcs. a set.....	6.00B
AG1160760	Strap Button Screws	Strap button mounting screws, oval head, 2 pcs. a set.....	4.00B
AG1160860	Neck Screws	Neck plate mounting screws, oval head, 4 pcs. a set .....	6.00B

PRICES SUBJECT TO CHANGE WITHOUT NOTICE



# Q-PARTS® AGED COLLECTIONS



## For Stratocaster®

<b>AG1158560</b>	Tuners	'57 Kluson® Deluxe style tuner, 6-single vertical line, metal knobs, including bushings and screws .....	<b>\$46.00B</b>
<b>AG1158660</b>	String Retainers	'59 butterfly string guides with low metal spacer .....	<b>3.00B</b>
<b>AG1158760</b>	Neck Plates	60's 4-mounting holes neck plate 0.08" (2mm) thickness .....	<b>12.00B</b>
<b>AG1158892</b>	Knobs	ABS, 1 vol. - 2 tone knob set, fitted on inch or metric pot shafts .....	<b>12.00B</b>
<b>AG1158960</b>	Strap Buttons	STD Fender® replacement vintage strap button w/felt washer .....	<b>4.00B</b>
<b>AG1159060</b>	Jack Plates	STD Strat® replacement input jack plate for 1/4" plug.....	<b>10.00B</b>
<b>AG1159160</b>	Tremolos	'57 Strat® replacement vintage tremolo set, steel saddles and steel tone block, 2.20" (56mm) string wide, included all hardware and screws .....	<b>44.00B</b>
<b>AG1159292</b>	Tremolo Arm Tip	Tremolo arm knob, 0.188" (4.8mm) inside diameter .....	<b>4.00B</b>
<b>AG1159392</b>	Lever Switch Tip	Pickup selector tip, fitted for domestic and imported switches .....	<b>3.00B</b>
<b>AG1159445</b>	Nuts	Pre-made STD Strat® and Tele® replacement bone nut with oil treatment, 1.692" L (43mm) x 0.196" H (5mm) x 0.133" T (3.4mm) .....	<b>14.00B</b>
<b>AG1159560</b>	Jack	STD 1/4" mono output jack, fits for most guitars .....	<b>4.00B</b>
<b>AG1160060</b>	Pickguard Screws	4-13 inch threaded pickguard mounting screws, oval, phillips head, 12 pcs. a set.....	<b>6.00B</b>
<b>AG1160160</b>	Pickup Screws	6-32 inch threaded single pickup pickguard mounting screws, pan head, 6 pcs. a set.....	<b>6.00B</b>
<b>AG1160260</b>	Pickup Screws	6-32 inch threaded single pickup pickguard mounting screws, oval, w/c-sink, 6 pcs. a set.....	<b>6.00B</b>
<b>AG1160360</b>	Tremelo Screws	Tremelo mounting screws, with slot on neck, pan head, 6 pcs. a set.....	<b>6.00B</b>
<b>AG1160460</b>	Switch Screws	6-32 inch threaded lever switch mounting screws, pan head, 2 pcs. a set.....	<b>4.00B</b>
<b>AG1160560</b>	Switch Screws	6-32 inch threaded lever switch mounting screws, oval, w/c-sink, 2 pcs. a set.....	<b>4.00B</b>
<b>AG1160660</b>	Jack Plate Screws	Jack plate mounting screws, oval head, 2 pcs. a set.....	<b>4.00B</b>
<b>AG1160760</b>	Strap Button Screws	Strap button mounting screws, oval head, 2 pcs. a set.....	<b>4.00B</b>
<b>AG1160860</b>	Neck Screws	Neck plate mounting screws, oval head, 4 pcs. a set .....	<b>6.00B</b>

## For Les Paul®

<b>AG3166060</b>	Tuners	'58 Les Paul replacement tuning gears with sting hole post, R3+L3 combination .....	<b>50.00B</b>
<b>AG3166140</b>	Knobs	Gibson® Bell type knob for INCH pots (24 teeth) shafts only. Check your pots before buying .....	<b>3.00B</b>
<b>AG3166260</b>	Strap Buttons	Gibson® vintage replacement strap button with felt washer .....	<b>4.00B</b>
<b>AG3166360</b>	Bridges	'62 ABR-1 type bridge with string slots on saddles, wire prevented saddles.....	<b>36.00B</b>
<b>AG3166460</b>	Tails	Gibson® vintage replacement aluminum stop bar tailpiece .....	<b>36.00B</b>
<b>AG3166545</b>	Nuts	Pre-cut STD Gibson® replacement bone nut with oil treatment, 1.707" L (43.4mm) x 0.352" H (8.95mm) x 0.236" T (6mm) .....	<b>14.00B</b>
<b>AG1159560</b>	Jack	STD 1/4" mono output jack, fits for the most guitars.....	<b>4.00B</b>
<b>AG3166745</b>	Jack Cover	STD Gibson® square type plastic jack cover.....	<b>4.00B</b>
<b>AG3166845</b>	Toggle Switch	Double poles 3-way pickup toggle switch for two pickups.....	<b>16.00B</b>
<b>AG3166911</b>	Toggle S/W Tip	8-32 threaded toggle switch tip .....	<b>4.00B</b>
<b>AG3167045</b>	Toggle S/W Plate	STD plastic round toggle switch plate .....	<b>6.00B</b>
<b>AG3167345</b>	PU Mounting Ring	Bridge & neck pickup MT ring, flat sole, set .....	<b>16.00B</b>
<b>AG3167445</b>	Pickguards	STD Les Paul® replacement vintage pickguard, single layer with squared edge cut .....	<b>28.00B</b>
<b>AG3167560</b>	Pickguard Bracket	STD pickguard support bracket.....	<b>6.00B</b>
<b>AG1160060</b>	Pickguard Screws	4-13 inch threaded pickguard mounting screws, oval, phillips head, 12 pcs. a set.....	<b>10.00B</b>
<b>AG3167860</b>	Pickup Screws	3-48 inch threaded, 1 1/4" long pickup mounting screws, pan had, 4 pcs. a set .....	<b>8.00B</b>
<b>AG3167960</b>	Indicator	Knob indicators for the 50's Gibson® guitars, 3/8" (10mm) inside diameter, 4 pcs. a set. Check your pots before buying.....	<b>6.00B</b>
<b>AG3168060</b>	Ring Screws	Pickup ring mounting screws for neck pickups, flat head, 4 pcs. a set.....	<b>6.00B</b>
<b>AG3168160</b>	Ring Screws	Pickup ring mounting screws for bridge pickups, flat head, 4 pcs. a set.....	<b>6.00B</b>
<b>AG1160760</b>	Strap Button Screws	Strap button mounting screws, oval head, 2 pcs. a set.....	<b>4.00B</b>

Fender, Strat, Tele, Jazz Bass and P-Bass are registered trademarks of FMIC. Gibson and Les Paul are registered trademarks of Gibson USA. Q-Parts is not affiliated with these companies in any way.

**Note: Q-Parts® Knobs on Page 95**

PRICES SUBJECT TO CHANGE WITHOUT NOTICE

# FENDER PARTS

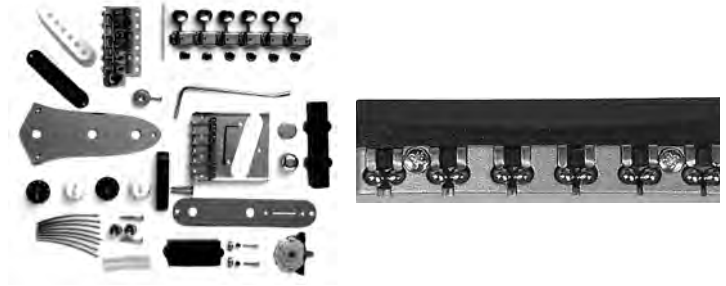

## BRIDGE KITS

<b>0810</b>	6 Section Tele Bridge Kit .....	<b>\$90.00</b>
<b>2049</b>	Tremolo Bridge – Vintage Strat .....	<b>183.60</b>
<b>2051</b>	Strat Saddles – Vintage Strat .....	<b>49.35</b>

## STRING GUIDE

<b>4911000</b>	Am. Std. String Guides (2 pc) .....	<b>\$10.20</b>
<b>4912000</b>	Original Tele String Guide (1pc) .....	<b>12.75</b>
<b>4913000</b>	Original J/PBass String Guide (1pc).....	<b>9.20</b>

## FRET WIRE

<b>2014</b>	Vintage Guitar – 24 pieces.....	<b>\$14.95 pk</b>
-------------	---------------------------------	-------------------

## STRAP BUTTON

<b>4915000</b>	Vintage Guitar/Bass – 2 per bag .....	<b>\$6.90</b>
----------------	---------------------------------------	---------------

## KNOBS

<b>1366</b>	Chrome Flat-Top, Tele & P-Bass – set of 2 .....	<b>\$24.25</b>
<b>2056</b>	Chrome Dome Knobs, Vintage Tele – set of 2 .....	<b>24.25</b>
<b>2035</b>	White Tone & Volume, Vintage Strat (3) .....	<b>8.05</b>
<b>1365</b>	Black Tone & Volume Strat (3) .....	<b>8.05</b>

## STRAT ACCESSORY KITS

*Includes backplate, pickup covers, tone & volume knobs, switch and tremolo arm tips.*

<b>1362</b>	White, Strat .....	<b>\$28.70</b>
<b>1363</b>	Black, Strat .....	<b>28.70</b>
<b>1368</b>	Aged White, Strat .....	<b>28.70</b>

## PICKUP COVERS

<b>2034</b>	White Vintage Strat – set of 3 .....	<b>\$11.50</b>
<b>1364</b>	Black Strat – set of 3 .....	<b>11.50</b>

## MISC.

<b>4936000</b>	Original Tele Switch Tips (2).....	<b>\$8.05</b>
<b>4939000</b>	Original Strat Switch Tips (2) .....	<b>5.10</b>
<b>2039</b>	Tremolo Arm – Vintage Strat .....	<b>17.25</b>
<b>2040</b>	Machine Heads – Vintage Strat/Tele .....	<b>63.15</b>
<b>2041</b>	3-Way Switch – Vintage Strat/Tele .....	<b>16.10</b>
<b>4920000</b>	Bone Nut – Vintage Strat/Tele – pkg of 2 .....	<b>6.90</b>
<b>2036</b>	Thumbrest – P & J Bass .....	<b>6.90</b>
<b>2055</b>	Control Plate, J-Bass, 3 Hole.....	<b>25.95</b>
<b>2058</b>	Control Plate, Vintage Tele .....	<b>22.95</b>
<b>2250</b>	4-Way Switch – Tele .....	<b>29.30</b>
<b>0913000</b>	Stereo Amp Jack .....	<b>10.20</b>
<b>4931000</b>	Tremolo Arm Springs – pkg of 12 .....	<b>7.65</b>

## AMERICAN STANDARD HARDWARE

<b>0812</b>	LSR Roller Nut (.008-.056) .....	<b>\$62.50</b>
<b>1367</b>	5-Way Selector Switch – w/blk & white switch tips .....	<b>14.90</b>
<b>2050</b>	Tremolo Bridge – American Standard Complete.....	<b>143.45</b>
<b>2052</b>	TBX Tone Control Kit .....	<b>18.35</b>
<b>2054</b>	Original Am. Std. Tremolo Arm .....	<b>15.85</b>
<b>0818</b>	Fender/Schaller Locking Tuners – Satin chrome.....	<b>126.25</b>
<b>0818100</b>	Locking Tuners, Polished chrome .....	<b>91.80</b>
<b>0840</b>	Strat Saddles (6) w/Screws & Springs.....	<b>26.80</b>
<b>4911000</b>	Strat String Guides – pkg of 2 .....	<b>10.30</b>
<b>0832</b>	No Load, 250K Split Shaft Pot .....	<b>11.45</b>
<b>0833</b>	No Load, 250K Solid Shaft Pot .....	<b>11.45</b>
<b>0830</b>	250K Split Shaft Pot.....	<b>6.45</b>
<b>0831</b>	250K Solid Shaft Pot .....	<b>10.20</b>
<b>0834</b>	500K Split Shaft Pot.....	<b>10.20</b>
<b>0835</b>	500K Solid Shaft Pot.....	<b>10.20</b>

## AMP PARTS AND HARDWARE

<b>0720000</b>	Piggyback Hardware Thumbscrews (2) .....	<b>\$18.35</b>
<b>0722000</b>	Piggyback Hardware Bushings (2) .....	<b>29.30</b>
<b>0723000</b>	Tube Shields (2) .....	<b>6.90</b>
<b>0943</b>	Amp Handle – Molded Black – Dog Bone .....	<b>10.20</b>
<b>0944</b>	Amp Handle – Brown Strap .....	<b>15.30</b>
<b>0945</b>	Amp Handle – Vintage Leather.....	<b>26.80</b>

## PART PACKS

<b>0819</b>	IPR Bk/IPR Red Fender Strap Blocks.....	<b>\$4.05</b>
<b>4914000</b>	Am. Std. Strap Buttons (2) .....	<b>7.30</b>
<b>4915000</b>	Original Strap Buttons (2) .....	<b>6.40</b>
<b>4917000</b>	Am. Std. Tele String Ferrules (6) .....	<b>12.75</b>
<b>4918000</b>	Original Tele String Ferrules (6).....	<b>14.00</b>
<b>4921000</b>	Am. Std. Std. P-Bass Nut .....	<b>12.75</b>
<b>4928000</b>	Original Strat Bridge Height Screws (12) .....	<b>6.40</b>
<b>4924000</b>	Gold Pickguard Screws (24) .....	<b>22.95</b>
<b>4923000</b>	Chrome Pickguard Screws (24) .....	<b>5.75</b>
<b>4946000</b>	Vintage Tuning Key Bushings (6) .....	<b>10.30</b>
<b>4925000</b>	Pickup / Switch Screws (12).....	<b>5.75</b>
<b>4926000</b>	Gold Pickup / Switch Screws (12) .....	<b>19.10</b>
<b>4929000</b>	Black Felt Washers (12).....	<b>7.65</b>
<b>4930000</b>	White Felt Washers (12).....	<b>6.40</b>
<b>4933000</b>	Original Strat Aged Trem Arm Tips (2) .....	<b>5.50</b>
<b>4934000</b>	Original Strat Black Trem Arm Tips (2) .....	<b>5.10</b>
<b>4935000</b>	Original Strat White Trem Arm Tips (2) .....	<b>4.95</b>
<b>4937000</b>	Original Tele "Top Hat" Switch Tips (2).....	<b>15.30</b>
<b>4920000</b>	Original Bone Nut Blanks (2) .....	<b>6.90</b>
<b>4916000</b>	Pickup Tubing (12) .....	<b>7.50</b>
<b>1447100</b>	Vintage Chrome Neck Plate, Plain w/Screws .....	<b>15.30</b>
<b>1445100</b>	Amer Std. Guitar Neck Plate .....	<b>20.40</b>
<b>1446100</b>	Amer Std. Bass Neck Plate .....	<b>19.15</b>
<b>1940100</b>	Chrome Strat Jack Plate .....	<b>12.75</b>
<b>0843</b>	Vintage Tele Brass Barrels (3) .....	<b>26.80</b>
<b>2251</b>	5-Way Super Switch.....	<b>31.85</b>

PRICES SUBJECT TO CHANGE WITHOUT NOTICE

## FENDER ACCESSORIES



### AMP KNOBS

<b>0930</b>	1-10 (Pkg of 6).....	<b>\$28.70</b>
<b>0931</b>	Red Pointer (Pkg of 6).....	<b>22.95</b>
<b>0932</b>	Black Pointe (Pkg of 6).....	<b>22.90</b>
<b>0933</b>	White Vintage.....	<b>28.70</b>
<b>0934</b>	Brown Vintage.....	<b>32.15</b>
<b>0935</b>	Black Chicken Head.....	<b>28.70</b>

### AMP HANDLES

<b>0943</b>	Black.....	<b>\$10.20</b>
<b>0944</b>	Strap Type.....	<b>15.30</b>
<b>0945</b>	Leather.....	<b>26.80</b>
<b>0946</b>	Molded Rubber (Dogbone).....	<b>12.75</b>
<b>0947</b>	Black Strap Vintage (1 Screw).....	<b>15.30</b>
<b>0948</b>	Black Strap Standard (2 Screw).....	<b>14.90</b>

### TILT BACK LEGS

<b>0712</b>	Chrome – 16".....	<b>\$63.15</b>
<b>0713</b>	Chrome – 19".....	<b>68.85</b>
<b>0714</b>	Chrome – 14".....	<b>57.40</b>



### PICKGUARDS

<b>1361</b>	P-Bass – White.....	<b>\$43.65</b>
<b>2017</b>	57 Strat – 1 ply, White.....	<b>28.70</b>
<b>2018</b>	62 Strat – 3 ply, White.....	<b>37.85</b>
<b>2019</b>	52 Telecaster – 1 ply, Black.....	<b>59.99B</b>
<b>2021</b>	62 P-Bass – 4 ply, Shell.....	<b>91.80</b>
<b>2022</b>	62 J-Bass – 4 ply, Shell.....	<b>63.10</b>
<b>2150</b>	Tele – White Pearl.....	<b>57.40</b>
<b>2154</b>	Tele – Mint Green.....	<b>40.15</b>

### BACK PLATES

<b>1320000</b>	White.....	<b>\$13.80</b>
<b>1321000</b>	Wh/Blk/Wh.....	<b>17.25</b>
<b>1322000</b>	Blk/Wh/Blk.....	<b>13.80</b>
<b>1324000</b>	Shell.....	<b>28.70</b>

### AMERICAN STANDARD

<b>1359</b>	Strat – 3 ply, Black.....	<b>\$34.45</b>
-------------	---------------------------	----------------



### GIG BAGS

<b>1512106</b>	Fender Urban Strat/Tele Guitar Gig Bag.....	<b>\$53.55</b>
<b>1522106</b>	Fender Urban Bass Gig Bag.....	<b>53.55</b>
<b>1532106</b>	Fender Urban Acoustic Gig Bag.....	<b>53.85</b>

### STANDARD GIG BAGS

<b>1412106</b>	Traditional Strat/Tele.....	<b>\$31.25</b>
<b>1422106</b>	Traditional J/P Bass.....	<b>31.25</b>
<b>1432106</b>	Traditional Dreadnaught.....	<b>31.25</b>

[www.fender.com](http://www.fender.com)

## WD PICKGUARDS



### TELECASTER

<b>TE101</b>	Solid Black.....	<b>\$19.95</b>
<b>TE102</b>	Solid White.....	<b>19.95</b>
<b>TE103</b>	Black/White/Black.....	<b>19.95</b>
<b>TE104</b>	White/Black/White.....	<b>19.95</b>
<b>TE105</b>	Tortoise Shell.....	<b>39.95</b>
<b>TE106</b>	Cream.....	<b>24.95</b>
<b>TE110</b>	Mirror.....	<b>36.95</b>
<b>TEN101</b>	Bk Nashville.....	<b>19.95</b>
<b>TE1G03</b>	Dixie Flag.....	<b>49.95</b>
<b>TE115</b>	Checker Board.....	<b>36.95</b>
<b>TE128</b>	White Pearl.....	<b>39.95</b>

### STRATOCASTER

<b>ST201</b>	Solid Black.....	<b>\$21.95</b>
<b>ST202</b>	Solid White.....	<b>21.95</b>
<b>ST203</b>	Black/White/Black.....	<b>21.95</b>
<b>ST204</b>	White/Black/White.....	<b>21.95</b>
<b>ST205</b>	Tortoise Shell.....	<b>59.95</b>
<b>ST206</b>	Cream.....	<b>29.95</b>
<b>ST207</b>	Red/White/Red.....	<b>34.95</b>
<b>ST207S</b>	Red.....	<b>34.95</b>
<b>ST208</b>	Blue/White/Blue.....	<b>29.95</b>
<b>ST210</b>	Mirror.....	<b>39.95</b>
<b>ST210B</b>	Blue Mirror.....	<b>39.95</b>
<b>ST210R</b>	Red Mirror.....	<b>36.95</b>
<b>ST210S</b>	Smoke Mirror.....	<b>44.40</b>
<b>ST2G02</b>	British Flag.....	<b>49.95</b>
<b>ST213</b>	Brushed Silver.....	<b>39.95</b>
<b>ST214</b>	Brushed Gold.....	<b>36.95</b>
<b>ST215</b>	Checkerboard.....	<b>49.95</b>
<b>ST223</b>	Spider Web.....	<b>36.95</b>
<b>ST224</b>	American Flag.....	<b>36.95</b>
<b>ST225</b>	Japanese Flag.....	<b>36.95</b>
<b>ST227</b>	Black Anodized.....	<b>36.95</b>
<b>ST228</b>	White Pearl.....	<b>49.95</b>
<b>ST228LH</b>	White Pearl, Leftie.....	<b>62.50</b>
<b>ST228BK</b>	Black Pearl.....	<b>49.95</b>
<b>ST234</b>	Vintage Mint Green.....	<b>39.95</b>
<b>ST245</b>	Clear.....	<b>40.10</b>



### TITLES FROM OUR MUSIC DEPARTMENT

<b>Guitar Identification</b> – Reference Guide to Serial Numbers For Dating the Guitars of Fender, Gibson, Martin and Gretsch.....	<b>\$12.95</b>
<b>Leonard Guitar Method Bk. 1</b> .....	<b>6.99</b>
<b>Leonard Guitar Method Bk. 1 Bk/CD</b> .....	<b>10.99</b>
<b>Leonard Guitar Method Bk. 1 Bk/CD/DVD</b> .....	<b>24.99</b>
<b>Leonard Guitar Method Bk. 1 DVD Video</b> .....	<b>19.95</b>

# WD REPLACEMENT PICKGUARDS & PARTS



## STRATOCASTER (2 Single Coil, 1 Humbucker)

ST201Q	Solid Black.....	\$29.95
ST202Q	Solid White.....	29.95
ST203Q	Black/White/Black.....	29.95
ST204Q	White/Black/White.....	29.95
ST205Q	Shell.....	59.95
ST210Q	Mirror.....	39.95
ST228Q	White Pearl.....	49.95
ST228BQ	Black Pearl.....	49.95

## STRATOCASTER (Single Humbucker)

ST201Z	Solid Black.....	\$21.95
ST202Z	Solid White.....	21.95
ST203Z	Black/White/Black.....	21.95
ST204Z	White/Black/White.....	21.95

## EXPLORER

EX1101	Black.....	28.95
--------	------------	-------

## SG

SG2129	Matte Black.....	49.95
--------	------------------	-------



## STRAT BACKPLATE

STB1	Solid Black.....	\$10.95
STB2	Solid White.....	10.95
STB3	Black/White/Black.....	10.95
STB4	White/Black/White.....	10.95
STB5	Tortoise Shell.....	29.95
STB6	Cream.....	14.95
STB10	Mirror.....	16.95
STB28	White Pearl.....	19.95



## BLANKS (9" x 15-1/2")

GB701	Black.....	\$19.50
GB702	White.....	19.50
GB703	Black/White/Black.....	19.50
GB704	White/Black/White.....	19.50
GB705	Shell.....	93.60
GB706	Cream.....	35.25
GB709	5 layer B/W/B/W/B.....	20.40
GB710	Mirror.....	41.60
SM1048	Black (.030 x 20" x 12").....	33.00



## RHYTHM/TREBLE PLATE

WDR1	Black.....	\$3.00
WDR6	Cream.....	3.00



## JAZZ BASS

JB301	Solid Black.....	\$21.95
JB302	Solid White.....	21.95
JB303	Black/White/Black.....	21.95
JB304	White/Black/White.....	21.95
JB305	Tortoise Shell.....	59.95
JB307	Red/White/Red.....	29.95
JB310	Mirror.....	40.15
JB328	White Pearl.....	49.95



## PRECISION BASS

PB401	Solid Black.....	\$28.95
PB402	Solid White.....	28.95
PB403	Black/White/Black.....	28.95
PB404	White/Black/White.....	28.95
PB405	Tortoise Shell.....	84.95
PB407	Red/White/Red.....	49.95
PB410	Mirror.....	63.95
PB428	Pearl.....	59.95



## LES PAUL

LP501	Solid Black.....	\$10.95
LP502	Solid White.....	10.95
LP503	Black/White/Black.....	10.95
LP504	White/Black/White.....	10.95
LP505	Tortoise Shell.....	29.95
LP506	Cream.....	14.95
LP510	Mirror.....	19.95
LPB1	Back Plate (Black).....	10.85
LPB6	Back Plate (Cream).....	17.95
LPS1	Switch Cover (Black).....	8.45
LPS6	Switch Cover (Cream).....	8.45
LPN506	Pickguard for Soapbar pickup.....	19.95
P100B	Black Jackplate.....	3.00
PB100IV	Cream Jackplate.....	3.00
BP603B	Black Truss Plate.....	6.80
BP603IV	Ivory Truss Plate.....	6.80
JP40B	Black LP Bracket.....	4.00
JP40C	Chrome LP Bracket.....	5.00
JP40G	Gold LP Bracket.....	6.00

Fender, Stratocaster, Strat, Telecaster, Precision Brass, P-Bass, Jazz Bass, J-Bass are Registered Trademarks of Fender...



PG1

PG1LH	Left Hand Teardrop, Black.....	\$6.00
PG1SLH	Left Hand Teardrop, Shell.....	8.50
PG1	Teardrop, Black.....	5.00
PG1S	Teardrop, Shell.....	7.50
HE232	Teardrop, w/adhesive, black.....	9.00
MM1900	Teardrop, Shell.....	7.50
MM1902	Teardrop, Black.....	7.50
376AC	Large, Clear Top Guard.....	6.65
376BC	Small, Clear Teardrop.....	4.65
HE202	Top Guard, White.....	6.05
HE203	Top Guard, Clear.....	6.05
376AS	Large, Shell, Top Guard.....	9.50



## GUITAR PARTS

JP70C	Telecontrol Plate (Chrome).....	\$25.00
JP60C	Jazz Control Plate (Chrome).....	30.00
JCS3C	Tele Jack Plate (Chrome).....	5.00
JCB2C	Football Jack Plate (Chrome).....	3.50
JCB2BK	Football Jack Plate (Black).....	4.50
PCTL	Tele P/U Cover (Chrome).....	10.00
JCB4C	LP Jack Plate (Chrome).....	7.00
WDE12GO	1/4" Gold Input Jack.....	10.00
SM4283	Tele Jack Plate.....	22.65

## STRAT RECESSED JACKPLATES

JCS1B	Black.....	\$9.99
JCS1C	Chrome.....	6.00
JCS1G	Gold.....	12.00

## STRAT KITS

Contains: Back Plate, P/U Covers, Trem Arm Knob, VT Knobs and Switch Tip. Available in (B) Black, (W) White, (AW) Antique White, (MG) Mint Green.  
MM5912 Specify color.....\$19.95

**FAX & E-MAIL ORDERS  
FOR PRINTED MUSIC  
WILL GET AN EXTRA  
5% DISCOUNT**

**FAX:  
(708) 496-2130  
(888) 983-5537**

**E-MAIL:  
sales@harristeller.com**

**WE STOCK PRINT MUSIC,  
INSTRUCTIONAL DVD'S,  
AND  
SING-A-LONG CD'S**

## WD REPLACEMENT PARTS

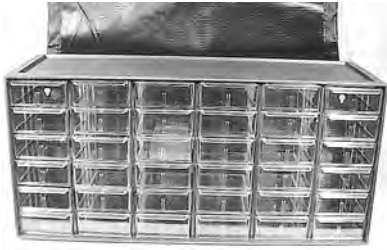

**WDRS** Asstd Replacement Parts & Cabinet .....\$524.85

### WD PARTS

<b>FNC</b>	Neck screw, Chrome .....	.33
<b>FNB</b>	Neck screw, Black.....	.70
<b>FNG</b>	Neck screw, Gold .....	2.35
<b>PGB</b>	Pickguard screw for Gibson®, Black .....	.36
<b>PGFB</b>	Pickguard screw for Fender®, Black.....	.21
<b>PGFC</b>	Pickguard screw for Fender®, Chrome.....	.20
<b>SPHB</b>	Single coil pickup screws, Black.....	3.45/8
<b>SPHC</b>	Single coil pickup screws, Chrome .....	3.00/8
<b>BN1</b>	Bone acoustic saddle.....	7.50
<b>BNA</b>	Bone acoustic nut.....	7.50
<b>BNF</b>	Bone nut for Fender® .....	6.50
<b>BNG</b>	Bone nut for Gibson® .....	8.50
<b>NTB01</b>	Brass nut for Fender® .....	9.99
<b>NTC1</b>	Graphite nut for Fender® .....	7.00
<b>NTC4</b>	Graphite nut for Gibson® .....	7.00
<b>TLBIB</b>	Ferrules, Black.....	15.00/6
<b>TLBIC</b>	Ferrules, Chrome .....	12.00/6
<b>TLBIG</b>	Ferrules, Gold .....	18.00/6
<b>TLB2B</b>	Bass ferrules, Black .....	10.00/4
<b>TLB2C</b>	Bass ferrules, Chrome .....	9.00/4
<b>WDSH44</b>	Tremolo Claw.....	2.00
<b>EPB2C</b>	Strap button, Chrome .....	5.00/2
<b>EPB2B</b>	Strap button, Black .....	4.00/2
<b>HMRS</b>	Humbucker mtg. ring screw.....	.15
<b>HPHB</b>	Humbucker height screw, Black .....	.20
<b>HPHC</b>	Humbucker height screw, Chrome.....	.20
<b>PN</b>	Pot nut .....	.18
<b>PW</b>	Pot washer .....	.30
<b>SBC</b>	Strap button screws, Chrome .....	1.80/6
<b>HBS</b>	Humbucker spring .....	.40
<b>SPS</b>	Single coil pickup spring.....	2.85/6
<b>HMRBH</b>	Humbucker mtg. ring high, Black .....	2.75
<b>HMRCH</b>	Humbucker mtg. ring high, Cream .....	2.75
<b>HMRBL</b>	Humbucker mtg. ring low, Black.....	2.75
<b>HMRCL</b>	Humbucker mtg. ring low, Cream.....	2.75
<b>SM1567</b>	3/16" Chrome mounting ring.....	29.95
<b>SM1568</b>	3/8" Chrome mounting ring .....	29.95
<b>NBS3C</b>	Neck plate, Chrome.....	6.00
<b>NBS3BK</b>	Neck plate, Black .....	10.00
<b>NBS3GO</b>	Neck plate, Gold.....	12.00
<b>O22</b>	.022 mf capacitor .....	.75
<b>O47</b>	.047 mf capacitor .....	.90
<b>RGIC</b>	String retainer, Chrome .....	3.00
<b>RGIBK</b>	String retainer, Black .....	3.00
<b>CVS4C</b>	Single coil pickup cover, Cream .....	9.00
<b>CVS4BK</b>	Single coil pickup cover, Black.....	9.00
<b>CVS4W</b>	Single coil pickup cover, White .....	8.25
<b>SS60</b>	Tremelo springs (5) .....	3.15
	Kluson adapter bushings.....	12.00/6

## SCREW KITS



A large assortment of most commonly used guitar screws in Chrome, Black and Gold

**HS6100** Schaller .....\$253.35

Assortment of commonly used screws on electric and acoustic guitars.

**WDSS** WD .....240.00

## SCHALLER PARTS

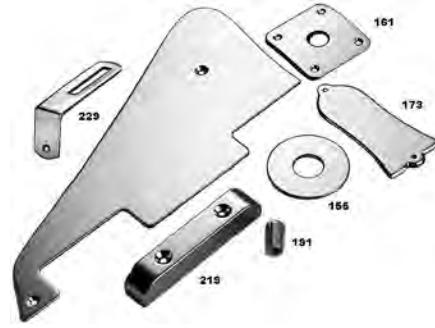

### HARDWARE

<b>HS112</b>	<b>17020213</b>	Pickup mounting ring, Chrome, 1/2" flat.....	\$36.15
<b>HS200</b>	<b>17020214</b>	Pickup mounting ring as 112 for arched guitar top .....	37.45
<b>HS199</b>	<b>17020514</b>	As 114 for arched guitar top .....	50.80
<b>HS118</b>	<b>17020211</b>	Pickup mounting ring, Chrome, 1/4" flat .....	29.15
<b>HS205</b>	<b>17020212</b>	As 118 but for arched guitar top, 1/4" .....	29.15
<b>HS203</b>	<b>17020512</b>	As 120 but for arched guitar top, 1/4" .....	40.35
<b>HS124</b>	<b>17023114</b>	Pickup mounting ring, ABS material, Creme, 1/2".....	9.95
<b>HS126</b>	<b>17023013</b>	Pickup mounting ring, ABS material, Black, 1/2" .....	9.95
<b>HS130</b>	<b>17023011</b>	Pickup mounting ring, ABS material, Black, 1/4" .....	9.30
<b>HS237H</b>	<b>17030215</b>	Height adjustment screws, 4 compression springs and 4 mounting ring screws, Chrome, for 1/2" mounting rings.....	7.60
<b>HS239H</b>	<b>17030515</b>	4 height adjustment screws, 4 compression springs and 4 mounting ring screws, Gold, for 1/2" mounting rings .....	8.45
<b>HS237FL</b>	<b>17030215</b>	4 height adjustment screws, 4 compression springs and 4 mounting ring screws, Chrome, for 1/4" mounting rings.....	7.60
<b>HS132B</b>	<b>17010203</b>	Humbucking cover for 6 adjustable pole pieces, bridge position Chrome plated .....	15.40
<b>HS132N</b>	<b>17010204</b>	As 132B but for neck position .....	15.40
<b>HS144</b>	<b>17010202</b>	Closed humbucking cover, Chrome .....	15.45
<b>HS154</b>	<b>17010201</b>	Open cover for humbuckers, fine chromium-plated.....	12.80
<b>HS156</b>	<b>17010501</b>	As 154 but fine Gold-plated .....	31.70
<b>HS162B</b>	<b>17013003</b>	Cover for pickups with 6 adjustable pole pieces, bridge position, Black.....	6.15
<b>HS174</b>	<b>17013002</b>	Black humbucker cover.....	5.85
<b>HS157</b>	<b>15200200</b>	Chrome toggle switch plate.....	4.00
<b>HS155</b>	<b>15200500</b>	As 153 but fine Gold-plated .....	9.00
<b>HS159</b>	<b>15190200</b>	Chrome jack plate .....	7.80
<b>HS1159</b>	<b>15190400</b>	Black version of HS159.....	13.35
<b>HS161</b>	<b>15190500</b>	As 159 but fine Gold-plated .....	14.55
<b>HS165</b>	<b>15180200</b>	Angle bracket for pick guard, Chrome .....	6.50
<b>HS167</b>	<b>15180500</b>	As 165 but fine Gold-plated .....	11.80
<b>HS189</b>	<b>15210200</b>	Button for treble-rhythm-switch, Chrome.....	2.25
<b>HS1189</b>	<b>15210400</b>	Black version of HS189.....	3.10
<b>HS191</b>	<b>15210500</b>	As 189 but fine Gold-plated .....	3.40
<b>HS221</b>	<b>15160200</b>	Thumb rest, Chrome .....	19.70
<b>HS1221</b>	<b>15160400</b>	Thumb rest Black .....	21.55
<b>HS219</b>	<b>15160500</b>	Thumb rest Gold .....	31.60
<b>HS229</b>	<b>15170500</b>	Pickguard Gold-plated.....	78.70
<b>HS151</b>	<b>15030200</b>	Turning knob, brass, Chrome (speed knob) .....	11.15
<b>HS176</b>	<b>15020200</b>	Chrome dome knob .....	9.95
<b>HS1176</b>	<b>15020400</b>	Black version of HS176.....	11.37
<b>HS233</b>	<b>15230200</b>	Allen Wrench Set .....	17.15

Prices may vary due to Euro/Dollar fluctuation

[www.schaller-electronic.com](http://www.schaller-electronic.com)

Fender, Stratocaster, Strat, Telecaster, Precision Brass, P-Bass, Jazz Bass, J-Bass are Registered Trademarks of Fender.

## BRIDGE PINS / END PINS



<b>PLASTIC</b>	
<b>WDBPB</b>	Black, WD .....\$ .20 ea.
<b>WDBPW</b>	White, WD ..... .20 ea.
<b>1550</b>	Black .....6.95 dz.
<b>1551</b>	Cream .....6.95 dz.

<b>EBONY</b>	
<b>3332</b>	Ebony, plain .....\$3.75 ea.
<b>3333</b>	Ebony, with eye.....5.00 ea.

### PEAVEY

<b>00444130</b>	Pin Set, Black .....\$2.39B/6
<b>00444140</b>	Pin Set, White .....2.39B/6



<b>WDBPBDLX</b>	Black/White, WD ..... .50 ea.
<b>WDBPWDLX</b>	White/Black, WD ..... .50 ea.



### GRAPH TECH

Bridge Pins with Dot	
<b>PP1000</b>	White Tusq., 4mm dot .....\$27.95/6
<b>PP2000</b>	Black Tusq., 4mm dot .....27.95/6
<b>PP1182</b>	Paua White Tusq., 2mm dot.....27.95/6
<b>PP2182</b>	Paua Black Tusq., 2mm dot .....27.95/6
<b>PP1122</b>	White Tusq., 2mm dot .....24.95B/6
<b>PP2122</b>	Black Tusq., 2mm dot.....24.95B/6
<b>PP1142</b>	White Tusq., mop dot .....27.95
<b>PP2142</b>	Black Tusq., mop dot .....27.95
<b>PP3000</b>	Black Tusq. ....21.55/6
<b>PP1044</b>	Tusq. Bridge Pins
	Wht./MOP dot .....27.95/6
<b>PP110001</b>	Tusq. Bridge Pins Wht. no dot ....21.55/6
<b>PP2044</b>	Tusq. Bridge Pins 4mm
	Blk./MOP dot .....27.95/6
<b>PP210001</b>	Tusq. Bridge Pins Blk. no dot .....21.55/6
<b>PP4000</b>	Tusq. Bridge Pins Wht. no dot ....21.55/6

### AP POWER PINS

#### Acoustic Guitar Stringing System

Kit includes six pins, each with three flat washers and one lock washer.

<b>PPAGA10C</b>	Chrome .....\$64.99B/6
<b>PPAGA20B</b>	Black .....67.99B/6
<b>PPAGA30G</b>	Gold.....70.99B/6



### TONE PINS

<b>TP1B</b>	Brass.....\$13.35/6
<b>TP2A</b>	Abalone.....25.00/6
<b>TP3M</b>	Mother of Pearl.....25.00/6
<b>TP4T</b>	Traditional Pearl .....25.00/6



### MARTIN

<b>BRIDGE &amp; END PIN SETS</b>	
<b>MPP28</b>	White w/black dot, Martin .....\$9.00
<b>MPP45</b>	White w/pearl inlay, Martin .....14.00
<b>MPP</b>	White Pack, Martin.....6.00
<b>MPP15</b>	Black Pack, Martin .....6.00
<b>MPP17</b>	Ebony Pack, Martin .....16.00
<b>MPP21</b>	Black/White Pack, Martin .....8.00
<b>MPP42</b>	Black/Pearl Pack, Martin .....14.00
<b>MPP50</b>	Ebony/Pearl Pack, Martin .....24.00
<b>MPP60</b>	White/Shell Pack, Martin.....14.00
<b>MPPBI</b>	Acoustic Bass, Martin .....13.00/pk



### PLANET WAVES

<b>EBONY BRIDGE &amp; END PINS</b>	
<b>PWPS1</b>	7 Bridge/1 End.....\$18.99
<b>PWPS2</b>	7 Bridge/1 End,w/Abalone .....28.99
<b>PWPS3</b>	7 Bridge/1 End, w/Pearl.....29.99



<b>BOXWOOD BRIDGE &amp; END PINS</b>	
<b>PWPS6</b>	7 Bridge, 1 End .....\$20.99
<b>PWPS7</b>	7 Bridge, 1 End, w/Blk Pl. ....36.99



Injection Molded Bridge/End Pins	
<b>PWPS9</b>	7 Bridge/1 End, Black .....\$5.99
<b>PWPS10</b>	7 Bridge/1 End, Black w/Ivory dot....5.99
<b>PWPS11</b>	7 Bridge/1 End, Ivory .....5.99
<b>PWPS12</b>	7 Bridge/1 End, Ivory w/Black dot....5.99



### DANDREA

<b>BRIDGE &amp; END PIN SETS</b>	
<b>BPW</b>	White.....\$3.20
<b>BPB</b>	Black .....3.20



<b>MIGHTY MITE</b>	
<b>MM2300</b>	7 Bridge, White/Black, 1 End.....\$6.99
<b>MM2302</b>	7 Bridge, Black/White, 1 End.....6.99
<b>MM2304</b>	7 Bridge, Cream/White, 1 End.....6.99

## GUITAR END PINS



<b>PLASTIC</b>	
<b>3334</b>	Black .....\$ .45
<b>3335</b>	White ..... .45



<b>EBONY</b>	
<b>3336</b>	Ebony, Plain .....\$4.50
<b>3337</b>	Ebony, with pearl .....5.00



PP7211



PP7182



PP7282

### GRAPH TECH

<b>PP7100</b>	Tusq. End Pin Wht. no dot 1 pc.....\$12.95
<b>PP7142</b>	Tusq. End Pin Wht./MOP dot 1 pc. 16.95
<b>PP7182</b>	Tusq. End Pin Wht./Paua dot 1 pc. 16.95
<b>PP7211</b>	Tusq. End Pin Blk. no dot 1 pc.....12.95
<b>PP7242</b>	Tusq. End Pin Blk./MOP dot 1 pc. ..16.95
<b>PP7282</b>	Tusq. End Pin Blk./Paua dot 1 pc. ..16.95



### TROPHY

#### BRIDGE & END PIN ASSORTMENT

Includes 180 pieces: plain plastic guitar bridge pins in black, white and ivory colors. 108 pieces: plastic bridge pins with dot in black, white and ivory colors. 48 pieces: plastic guitar end pins with screws in black, white and brown colors. 18 pieces: plastic guitar end pins without screws in black, white and brown colors.

<b>GP172</b>	.....\$104.55
<b>GPP</b>	Pin Puller ..... .90

## DUNLOP PIN PULLER



This brilliant patented pin puller is ergonomically designed for easy grip, and eliminates any chance of damaging your bridge or pin. The direct pulling action is simple, efficient, and works on both 6 and 12 string guitars. Manufactured in strong "scratch free" plastic, this product is a guitar tech's dream. **7016J** Display Jar / 20 Pieces.....\$43.86

## KNOB



**KNOB (2 TONE, 1 VOL.)**  
**WDKB240** Black.....\$6.00/3  
**WDKI240** Creme.....6.00/3  
**WDKW240** White.....6.00/3



**DOMES KNOB**  
**BBKC** Chrome.....\$10.00/2  
**BBKB** Black.....13.00/2  
**BBKG** Gold.....13.00/2

**BELL KNOB**  
**KG160** Gold.....\$7.50/2  
**KA160** Amber.....7.50/2  
**KB160** Black.....7.50/2

**VOLUME/TONE KNOB**  
**KB130** Black.....\$7.50/2  
**KG130** Gold.....7.50/2

**BASS KNOB**  
**WDKB140** J-Bass.....\$6.00/3

**AMP KNOB**  
**WDKB150**.....\$3.99



**BARREL KNOB**  
**TBKC** Chrome w/screw.....\$12.00/2  
**TBKG** Gold w/screw.....15.00/2  
**TBKB** Black w/screw.....13.00/2



**SPEED KNOB**  
**MM902** Black.....\$6.95/2  
**MM900** White.....6.95/2  
**MM904** Gold.....6.95/2

## PEAVEY® GUITAR DOME KNOB



Metal dome guitar knob. Set screw equipped for tightening onto 1/4" solid-shaft pot. Knurled grip.

**00073220** Black Guitar Dome Knobs (pkg. 2).....\$7.59B  
**00073210** Chrome Guitar Dome Knobs (pkg. 2).....7.99B  
**00073200** Gold Guitar Dome Knobs (pkg. 2).....8.59B



**KNOB**  
**DCKA110** Amber, Speed.....\$7.00/2  
**DCKA160** Amber, Bell.....7.00/2  
**DCKB110** Black, Speed.....7.00/2  
**DCKB160** Black, Bell.....7.00/2  
**DCKG110** Gold, Speed.....7.00/2  
**DCKG160** Gold, Bell.....7.00/2  
**DCKW160** White, Bell.....7.00/2

**DOMES KNOB**  
**MM906** Black.....\$9.95/2  
**MM907** Gold.....9.95/2  
**MM908** Chrome.....9.95/2  
**MM909BK** Black w/screw.....9.95/2  
**MM909C** Chrome w/screw.....9.95/2  
**MM909GO** Gold w/screw.....9.95/2



84 assorted replacement guitar knobs in an attractive cabinet.  
**WDKS**.....\$315.00

## SWITCHES



**EB6371** 3 Way, E.Ball.....\$24.00  
**EB6370** 5 Way, E.Ball.....25.00  
**HS105** Schaller, 5 Way.....32.80



**MM500** Mighty Mite, 3 way.....7.95  
**MM503** Mighty Mite, 5 way.....9.95  
**DC3WAY** 3 Way.....7.75  
**DC5WAY** 5 Way.....7.75



**WD SWITCHES**  
**WDE3** Centralab 3 way.....\$13.50  
**WDE4** 4 way Tele.....22.50  
**WDE5** Centralab 5 way.....13.50  
**WDE6SW** Right angle.....24.99  
**WDE7** LP style toggle switch - short, straight.....15.00  
**WDE7GM** Gold WDE7 w/tip.....22.50



**WDE9** Mini on/on.....\$ 8.00  
**WDE10** Mini on/off/on.....9.00  
**WDE11** Mini on/on/on.....12.00  
**WDE9BK** Mini on/on, Black.....8.50  
**WDE10BK** Mini on/off/on, Black.....10.00  
**WDE11BK** Mini on/on/on, Black.....15.00  
**DCLPS** LP Toggle.....7.50

**TOGGLE TIPS**  
**WDTB340** Black, LP.....\$1.25  
**WDTI340** Creme, LP.....1.75  
**TSKB** Black, tele.....1.75

**5-WAY SWITCH TIPS**  
**WDSSKB** Black.....\$1.80  
**WDSSKC** Creme.....1.80  
**WDSSKW** White.....1.80

## POTENTIOMETERS



**E.BALL**  
**EB6381** 500K, Split Shaft.....\$8.75  
**EB6382** 250K, Solid Shaft.....8.75  
**EB6383** 250K, Split Shaft.....8.75



**POTENTIOMETERS**  
**WD250** Split shaft 250K.....\$ 5.00  
**WD500** Split shaft 500K.....5.00  
**WD1000** 1 Meg.....5.50  
**WD500XL** long shaft 500K.....11.50  
**WD250PP** 250K push pull.....15.00  
**WD500PP** 500K push pull.....15.00

**CRUZTOOL**  
**GTJPT1** Jack/pot tool.....18.95



**POTS**  
**DC250** 250K.....\$3.00  
**DC250S** 250K, Mini.....3.00  
**DC500** 500K.....3.00  
**DC500S** 500K, Mini.....3.00  
**MM700** A250K dime size.....4.95  
**MM702** D500K dime size.....4.95  
**EP1200** DiMarzio 250K.....9.00  
**EP1200PP** Push/Pull 250K.....14.95  
**EP1201PP** Push/Pull 500K.....14.95  
**EP1201** DiMarzio 500K.....9.00  
**EP1202** 1 Meg.....14.25  
**EP1201L** 500K Long Shaft.....11.50

## Q PARTS



### SHELL INLAY DOME KNOB

**KBD0001** Black Knob w/Blue Abalone.....\$12.00  
**KCD0002** Chrome Knob w/Blue Abalone.....12.00  
**KBD0004** Black Knob w/Abalone.....12.00  
**KCD0005** Chrome Knob w/Abalone.....12.00  
**KBD0010** Black Knob w/Red Abalone.....12.00  
**KCD0011** Chrome Knob w/Red Abalone.....12.00  
**KBD0019** Black Knob w/Green Abalone.....12.00  
**KCD0020** Chrome Knob w/Green Abalone.....12.00  
**KBD0022** Black Knob w/Mother of Pearl.....12.00  
**KCD0023** Chrome Knob w/Mother of Pearl.....12.00  
**KBD0028** Black Knob w/Leopard.....12.00  
**KCD0029** Chrome Knob w/Leopard.....12.00



### METAL INLAY DOME KNOB

**KBD0109** Black Knob w/Cross.....\$12.00  
**KCD0110** Chrome Knob w/Cross.....12.00  
**KBD0118** Black Knob w/Angry Skull.....12.00  
**KCD0119** Chrome Knob w/Angry Skull.....12.00  
**KBD0124** Black Knob w/Skull & Bones.....12.00  
**KCD0125** Chrome Knob w/Skull & Bones.....12.00



### GLASS INLAY DOME KNOB

**KBD0076** Black Knob w/Blue Cat's Eye.....\$12.00  
**KCD0077** Chrome Knob w/Blue Cat's Eye.....12.00  
**KBD0079** Black Knob w/Black Cat's Eye.....12.00  
**KCD0080** Chrome Knob w/Black Cat's Eye.....12.00



### CUSTOM DOME KNOB

**KBSI0400** Black Knob w/Skull I.....\$12.00  
**KCSI0401** Chrome Knob w/Skull I.....12.00  
**KBJSI0403** Black Knob w/Jumbo Skull I.....12.00  
**KCSII0404** Chrome Knob w/Jumbo Skull I.....12.00  
**KBSII0406** Black Knob w/Skull II.....12.00  
**KCSII0407** Chrome Knob w/Skull II.....12.00  
**KBJSII0409** Black Knob w/Jumbo Skull II.....12.00  
**KCSII0410** Chrome Knob w/Jumbo Skull II.....12.00



### ACRYLIC INLAY DOME KNOB

**KBD0046** Black Knob w/Tortoise.....\$8.00  
**KCD0047** Chrome Knob w/Tortoise.....8.00  
**KBD0049** Black Knob w/Black Pearl.....8.00  
**KCD0050** Chrome Knob w/Black Pearl.....8.00  
**KBD0052** Black Knob w/White Pearl.....8.00  
**KCD0053** Chrome Knob w/White Pearl.....8.00  
**KBD0055** Black Knob w/Red Pearl.....8.00  
**KCD0056** Chrome Knob w/Red Pearl.....8.00  
**KBD0058** Black Knob w/Blue Pearl.....8.00  
**KCD0059** Chrome Knob w/Blue Pearl.....8.00  
**KBD0067** Black Knob w/Purple Pearl.....8.00  
**KCD0068** Chrome Knob w/Purple Pearl.....8.00  
**KBD0070** Black Knob w/Aqua Pearl.....8.00  
**KCD0071** Chrome Knob w/Aqua Pearl.....8.00



# BRIDGES

## FLOYD ROSE

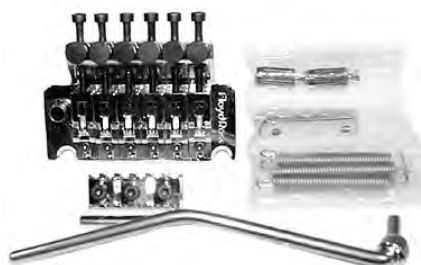

<b>FRT100R2</b>	Chrome w/R2 nut.....	<b>\$352.50</b>
<b>FRT100R4</b>	Chrome w/R4 nut.....	<b>352.50</b>
<b>FRT200R2</b>	Black w/R2 nut.....	<b>375.30</b>
<b>FRT200R4</b>	Black w/R4 nut.....	<b>375.30</b>
<b>FRNR2C</b>	R2 nut, Chrome .....	<b>42.60</b>
<b>FRNR2B</b>	R2 nut, Black.....	<b>44.40</b>
<b>FRNR4C</b>	R4 nut, Chrome .....	<b>42.60</b>
<b>FRNR4B</b>	R4 nut, Black.....	<b>44.40</b>



**GTC201C**

<b>GUITAR</b>		
<b>T20C</b>	Vintage Tele 3 Saddles .....	<b>\$60.00</b>
<b>SS48</b>	Vintage Tele 6 Saddles .....	<b>17.80</b>
<b>MM1135C</b>	Chrome, Tele 3 Saddles .....	<b>35.85</b>
<b>GTC201C</b>	Chrome, Tele 6 Saddles .....	<b>75.00</b>
<b>GTC301C</b>	Chrome w/Humbuck Cut 6 Saddles .....	<b>75.00</b>
<b>S20N</b>	3 Nickel Tele Saddles.....	<b>36.80</b>
<b>S40N</b>	6 Nickel Tele Saddles .....	<b>47.55</b>

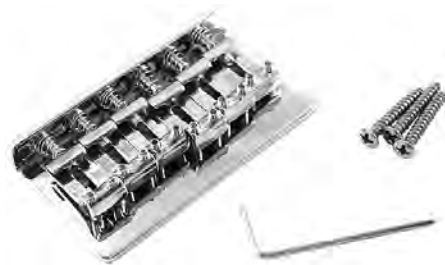

<b>WD108C</b>	Chrome, No Trem .....	<b>\$55.00</b>
<b>OGE101TC</b>	Chrome, with Trem .....	<b>45.00</b>
<b>OGE101TG</b>	Gold, with Tremolo .....	<b>55.00</b>
<b>S101N</b>	Vintage Saddles (6).....	<b>43.95</b>
<b>WD101C</b>	Chrome, Top Mount .....	<b>45.00</b>

<b>BASS</b>		
<b>WD100C</b>	Chrome, Bass, Barreled.....	<b>\$30.00</b>
<b>WD105C</b>	Bass, Knurled Saddle .....	<b>36.00</b>
<b>GE201C</b>	Chrome, Bass .....	<b>79.95</b>
<b>GE203N</b>	OEM Style Bass .....	<b>65.30</b>

## WD TREMOLOS



FR Style Bridge With 1 5/8" Locking Nut

<b>WDFRBK</b>	Black .....	<b>\$225.00</b>
<b>WDFRC</b>	Chrome.....	<b>200.00</b>
<b>WDFRG</b>	Gold.....	<b>235.00</b>

## MIGHTY MITE TREMOLOS



<b>MM1100</b>	Vintage Chrome ....	<b>\$30.00</b>
<b>MM1100S</b>	Saddles 6 Pk.....	<b>9.95</b>
<b>MM1102</b>	Floating Chrome.....	<b>35.00</b>
<b>MM1112</b>	Chrome .....	<b>40.00</b>
<b>MM1114</b>	Black.....	<b>50.00</b>
<b>MM1116</b>	Gold .....	<b>40.00</b>

## GROVER TREMOLO



Each saddle is adjustable for height and intonation. Available in black or chrome finish.

<b>500C</b>	Chrome .....	<b>\$39.50</b>
-------------	--------------	----------------

## MIGHTY MITE



<b>MMBL002B</b>	Black .....	<b>\$99.00</b>
<b>MMBL002C</b>	Chrome .....	<b>89.00</b>

**LOCK NUTS**

<b>MMPL001BBM</b>	1 5/8" Black.....	<b>\$14.95</b>
<b>MMPL001CBM</b>	1 5/8" Chrome.....	<b>15.95</b>
<b>MMPL001GBM</b>	1 5/8" Gold.....	<b>16.95</b>
<b>MMPL002BBM</b>	1 1/16" Black.....	<b>15.95</b>
<b>MMPL002CBM</b>	1 1/16" Chrome .....	<b>14.95</b>
<b>MMPL002GBM</b>	1 1/16" Gold.....	<b>16.95</b>

## TREMOLO ARMS

<b>WDC1C</b>	Chrome, F. Rose ....	<b>\$12.00</b>
<b>WDC1BK</b>	Black, F. Rose.....	<b>13.50</b>
<b>AB400</b>	Knob, Black .....	<b>2.00</b>
<b>AW400</b>	Knob, White .....	<b>2.00</b>



**TREMOLO MOUNTING STUDS**

<b>P1087TB</b>	Black .....	<b>\$16.00 pr.</b>
----------------	-------------	--------------------

## BENDING SYSTEMS



Automatically bends third string (G) up to "G#" or "A". Low profile accommodates right hand technique.

<b>10300C</b>	.....	<b>\$274.15</b>
---------------	-------	-----------------

Bends second string up a step.

<b>10100C</b>	.....	<b>\$209.10</b>
---------------	-------	-----------------

## GUITAR TAIL PIECES



<b>3550</b> .....	<b>\$7.95</b>	
Excellent quality, trapeze type.		
<b>SM189</b>	Chrome .....	<b>40.15</b>
<b>T120C</b>	Chrome .....	<b>37.50</b>

## HIPSHOT BASS BRIDGES

**VINTAGE STYLE BENT PLATE**

<b>5C400B</b>	4 String - Black.....	<b>\$83.20</b>
---------------	-----------------------	----------------

## HIPSHOT



<b>HIPTMB1</b>	3 hole mount, T. Type.....	<b>\$253.00</b>
<b>BRIDGES</b>		
<b>116HIPFBC</b>	Fixed, 2 1/16" Spacing.....	<b>\$101.35</b>
<b>116HIPFBBK</b>	Fixed, 2 1/16" Spacing .....	<b>101.35</b>
<b>HIPBGC</b>	Baby Grand, 2 1/16" Spacing .....	<b>110.00</b>
C=Chrome, BK=Black, GO=Gold		

## HIPSHOT BASS BRIDGES

<b>4 STRING</b>		
<b>4SA750C</b>	Chrome .750" Spacing.....	<b>\$118.40</b>
<b>4SA750BK</b>	Black .750" Spacing.....	<b>118.40</b>
<b>4SB750C</b>	Chrome .750" Spacing .....	<b>90.70</b>
<b>4SB750BK</b>	Black .750" Spacing.....	<b>90.70</b>
<b>5 STRING</b>		
<b>5SA669C</b>	Chrome .669" Spacing.....	<b>\$134.40</b>
<b>5SA669BK</b>	Black .669" Spacing .....	<b>134.40</b>
<b>5SB669C</b>	Chrome .669" Spacing .....	<b>97.10</b>
<b>5SB669BK</b>	Black .669" Spacing .....	<b>97.10</b>

Type A bridges feature variable string spacing adjustment.

Type B bridges feature barrel saddles.

## GRAPH TECH

### RESOMAX WRAP NWO

The new ResoMax Wrap Harmonic Bridge System is designed to maximize harmonic content and richness in every note. Comes equipped with ResoMax alloy saddles. AutoLock magnetically locking bridge. The bridge is completely comfortable for superior palm muting. Exclusive to the ResoMax system. Triple plated finish for durability and good looks.

<b>PM8593BN</b>	ResoMax Wrap NW1 Black Nickel .....	<b>\$169.95</b>
<b>PM8593CO</b>	ResoMax Wrap NW1 Chrome ..	<b>149.95</b>
<b>PM8593GO</b>	ResoMax Wrap NW1 Gold .....	<b>169.95</b>
<b>PM8593NO</b>	ResoMax Wrap NW1 Nickel .....	<b>149.95</b>



# SCHALLER BRIDGES



**HS455** Guitar, with tailpiece, chrome (12100200).....\$114.25  
**HS457** Guitar, with tailpiece, gold (12100500) ..... 132.00



**HS456** Guitar, with fine tuners, chrome (12110200).....\$147.80  
**HS1456** Guitar, with fine tuners, Black (12110400) .....147.80



**HS463** Chrome (12130201) .....\$104.15



The Original.  
**HS45060** Nickel (12090100) .....\$75.20  
**HS45061** Chrome (12090200) ..... 76.70  
**HS45062** Gold (12090500).....96.90  
**HS145060** Black (12090400) .....89.05



**HS496** Chrome, 5 String.....\$115.00  
**HS497** Gold, 5 String..... 184.00  
**HS1496** Black, 5 String (12140401) .....136.00  
**HS471** Chrome, 8 String (12150200) .....133.30



Bass Bridge designed to mount flush to Bass body. Harmonically tunable. Provides excellent sustain.  
**HS467** Chrome (12130200) .....\$114.55  
**HS1467** Black (12130400) .....136.25



Guitar Bridge. 3 dimensional adjustment.  
**HS452** Chrome (12080200).....\$80.00  
**HS453** Gold (12080500)..... 100.90



**TAILPIECES**  
**HS49061** Chrome (12050200) .....\$62.90  
**HS149061** Black (12050400).....72.00



**HANNES STANDARD GUITAR BRIDGE**  
**HS48051** Chrome (12010200).....\$214.00  
**HS48053** Black (12010400) .....214.00

[www.schaller-electronics.com](http://www.schaller-electronics.com)

## BRIDGES/TAILPIECES



**GE101ZC** Chrome Stop Tailpiece, w/ Studs .....\$43.20  
**GE101ZB** Black Stop Tailpiece, w/ Studs .....53.90  
**GE101ZG** Gold Stop Tailpiece, w/ Studs .....56.70  
**SM168** Chrome Stop Tailpiece .....39.65  
**MMLPT1C** Chrome Stop Tailpiece, w/ Studs .....32.95



**BRIDGES (Tunomatic)**  
**GE101BB** Black .....\$70.35  
**GE101BC** Chrome .....51.30  
**GE101BG** Gold.....72.35  
**GE101BRSC** Chrome with Roller Saddles .....34.95



**SM1511** Chrome with Studs .....\$50.40  
**SM167** Chrome.....47.00  
**SM0401** Chrome Wrap Around.....82.35  
**T80C** LP Jr. Bridge and Tailpiece .....30.00  
**520N** Nickel .....29.65  
**520G** Gold.....39.50  
**520C** Chrome .....29.65

## MIGHTY MITE



**MM2102** L.P. Style Bridge – Gold .....\$20.00  
**MM2104** L.P. Style Bridge – Chrome .....16.95  
**MM2105** L.P. Style Stop Tailpiece – Gold .....18.95  
**MM2103** L.P. Style Stop Tailpiece – Chrome .....15.00

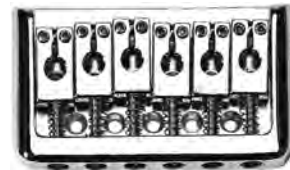

**MM2106C** Heavy Duty Hard Tail Bridge, w/Grommets – Chrome ....\$27.50  
**MMBM013C** LP Style Chrome .....21.95



**Mounting Hardware**  
**GE101BSWB** Black, screw & wheel .....\$11.00  
**GE101BSWC** Chrome, screw & wheel .....10.00  
**GE101BSWG** Gold, screw & wheel .....11.00

## TONE PROS



**LPBS02CH**



**TP6C**



**SCS1CH**

<b>LPBS02BLK</b>	Tunamatic set (small posts) Black.....	<b>\$156.35B</b>
<b>LPCS02CH</b>	Tunamatic set (small posts) Chrome .....	<b>116.50B</b>
<b>LPGS02GLD</b>	Tunamatic set (small posts) Gold .....	<b>132.50B</b>
<b>LPNS02NKL</b>	Tunamatic set (small posts) Nickel .....	<b>116.50B</b>
<b>LPBM04BLK</b>	Tunamatic set (small posts/notched saddles) Black.....	<b>156.35B</b>
<b>LPCM04CH</b>	Tunamatic set (small posts/notched saddles) Chrome ..	<b>116.50B</b>
<b>LPGM04GLD</b>	Tunamatic set (small posts/notched saddles) Gold.....	<b>147.35B</b>
<b>LPNM04NKL</b>	Tunamatic set (small posts/notched saddles) Nickel .....	<b>116.50</b>
<b>LPBM02BLK</b>	Metric Tunamatic set (large posts) Black .....	<b>147.35</b>
<b>LPCM02CH</b>	Metric Tunamatic set (large posts) Chrome .....	<b>116.50B</b>
<b>LPGM02GLD</b>	Metric Tunamatic set (large posts) Gold .....	<b>132.50B</b>
<b>LPNM02NKL</b>	Metric Tunamatic set (large posts) Nickel.....	<b>116.50B</b>
<b>AVR2C</b>	Replacement ABR-1 Tunamatic Chrome .....	<b>74.00B</b>
<b>AVR2G</b>	Replacement ABR-1 Tunamatic Gold .....	<b>82.40B</b>
<b>AVR2N</b>	Replacement ABR-1 Tunamatic Nickel .....	<b>64.00B</b>
<b>NVR2C</b>	AVR2 w/Standard Nashville Post Tuneomatic Chrome.....	<b>64.00B</b>
<b>NVR2N</b>	AVR2 w/Standard Nashville Post Tuneomatic Nickel .....	<b>64.00B</b>
<b>NVR2G</b>	AVR2 w/Standard Nashville Post Tuneomatic Gold .....	<b>69.75B</b>
<b>TP6B</b>	Tunamatic (small posts) Black .....	<b>82.40B</b>
<b>TP6C</b>	Tunamatic (small posts) Chrome.....	<b>64.00B</b>
<b>TP6G</b>	Tunamatic (small posts) Gold .....	<b>69.75B</b>
<b>TP6N</b>	Tunamatic (small posts) Nickel.....	<b>64.00B</b>
<b>TP6AS</b>	Metric Tunamatic (small post) Antique Silver .....	<b>79.75B</b>

<b>SBS1BLK</b>	Locking Studs - US thread Black .....	<b>\$44.40B</b>
<b>SCS1CH</b>	Locking Studs - US thread Chrome.....	<b>34.95B</b>
<b>SGS1GLD</b>	Locking Studs - US thread Gold .....	<b>39.95B</b>
<b>SNS1NKL</b>	Locking Studs - US thread Nickel.....	<b>38.85B</b>
<b>SBM1BLK</b>	Locking Studs - Metric Black .....	<b>39.95B</b>
<b>SCM1CH</b>	Locking Studs - Metric Chrome .....	<b>34.95B</b>
<b>SGM1GLD</b>	Locking Studs - Metric Gold.....	<b>39.95B</b>
<b>SNM1NKL</b>	Locking Studs - Metric Nickel .....	<b>34.95B</b>
<b>SPRS2CH</b>	Locking Studs Chrome.....	<b>44.95B</b>
<b>SPRS2GLD</b>	Locking Studs Gold.....	<b>49.95B</b>
<b>SPRS2NKL</b>	Locking Studs Nickel .....	<b>44.95B</b>
<b>MSPRSCH</b>	PRS Locking Studs Chrome - for Metric Santana guitar....	<b>44.95B</b>



**AVT2PN**

<b>T3BPB</b>	Tunamatic (small posts) notched saddles Black.....	<b>\$69.75B</b>
<b>T3BPC</b>	Tunamatic (small posts) notched saddles Chrome .....	<b>64.00B</b>
<b>T3BPG</b>	Tunamatic (small posts) notched saddles Gold .....	<b>69.75B</b>
<b>T3BPN</b>	Tunamatic (small posts) notched saddles Nickel .....	<b>71.15B</b>
<b>T3BTB</b>	Metric Tunamatic (large posts) Black .....	<b>69.75B</b>
<b>T3BTC</b>	Metric Tunamatic (large posts) Chrome .....	<b>64.00B</b>
<b>T3BTG</b>	Metric Tunamatic (large posts) Gold.....	<b>69.75B</b>
<b>T3BTN</b>	Metric Tunamatic (large posts) Nickel .....	<b>64.00B</b>

<b>AVT2PN</b>	Wraparound Set w/SPRS2-N Nickel (for PRS®) .....	<b>\$129.50B</b>
<b>AVT2PG</b>	Wraparound Set w/SPRS2-G Gold (for PRS®) .....	<b>144.50B</b>
<b>AVT2PC</b>	Wraparound Set w/SPRS2-C Chrome (for PRS®).....	<b>152.40B</b>
<b>AVT2MC</b>	Wraparound Set w/MSPRS-C Chrome (for PRS®) .....	<b>149.95B</b>
<b>AVT2GN</b>	Wraparound Set w/SNS1N Nickel (for Gibson®) .....	<b>129.50B</b>
<b>AVT2GG</b>	Wraparound Set w/SGS1G Gold (for Gibson®).....	<b>144.50B</b>
<b>AVT2GC</b>	Wraparound Set w/SNS1C Chrome (for Gibson®).....	<b>129.50B</b>
<b>AVT2GB</b>	Wraparound Set w/SBS1B Black (for Gibson®).....	<b>144.50B</b>
<b>T1ZSAB</b>	Standard Tailpiece Black ALUMINUM.....	<b>125.00B</b>
<b>T1ZSAG</b>	Standard Tailpiece Gold ALUMINUM .....	<b>130.25B</b>
<b>T1ZSAN</b>	Standard Tailpiece Nickel ALUMINUM .....	<b>100.00B</b>
<b>AVT2PSG</b>	Wraparound Set w/SPRS2SG SATIN GOLD Custom Color ..	<b>159.50B</b>
<b>T3BPCK</b>	Bridge (small post Metric) (Black Chrome) .....	<b>69.75B</b>
<b>T3BTSTG</b>	Bridge (large post Metric, notched) SATIN GOLD .....	<b>74.95B</b>
<b>T3BPSTG</b>	Bridge (small post, notched) SATIN GOLD .....	<b>74.95B</b>
<b>T3BTSTC</b>	Bridge (large post Metric, notched) SATIN CHROME .....	<b>77.50B</b>
<b>T3BPSTC</b>	Bridge (small post, notched) SATIN CHROME .....	<b>69.75B</b>



**T3BPB**



**T1ZSB**

<b>T1ZSB</b>	Standard Tailpiece Black .....	<b>\$69.70B</b>
<b>T1ZSC</b>	Standard Tailpiece Chrome .....	<b>52.50B</b>
<b>T1ZSG</b>	Standard Tailpiece Gold.....	<b>69.75B</b>
<b>T1ZSN</b>	Standard Tailpiece Nickel .....	<b>62.00B</b>
<b>T1ZB</b>	Metric Tailpiece Black.....	<b>62.75B</b>
<b>T1ZC</b>	Metric Tailpiece Chrome .....	<b>62.00B</b>
<b>T1ZG</b>	Metric Tailpiece Gold .....	<b>62.75B</b>
<b>T1ZN</b>	Metric Tailpiece Nickel .....	<b>52.50B</b>



**T1ZSCK**

<b>T1ZSCK</b>	Standard Tailpiece - COSMO BLACK.....	<b>\$62.75B</b>
<b>T1ZSTG</b>	Metric Tailpiece - SATIN GOLD .....	<b>67.75B</b>
<b>T1ZSSTG</b>	Standard Tailpiece - SATIN GOLD.....	<b>67.75B</b>
<b>T1ZSTC</b>	Metric Tailpiece - SATIN CHROME.....	<b>62.75B</b>
<b>T1ZSSTC</b>	Standard Tailpiece - SATIN CHROME .....	<b>62.75B</b>

### BRIDGE DOCTOR

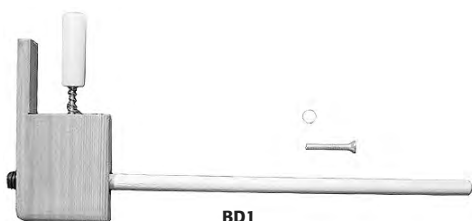

**BD1**

"Soundposts" for guitars. These internally mounted units markedly improve the tonal quality of any acoustic guitar.

<b>BD1</b>	2 Pin Block, Screw On .....	<b>\$31.50</b>
<b>BD1P</b>	6 Pin Block .....	<b>73.50</b>

**FAX & E-MAIL ORDERS  
FOR PRINTED MUSIC  
WILL GET AN EXTRA  
5% DISCOUNT**

**FAX:  
(708) 496-2130  
(888) 983-5537**

**E-MAIL:  
sales@harristeller.com**

## SCHALLER TREMOLOS

### TREMOLOS

HS1370	Black	.....	\$455.00
HS371	Gold	.....	536.70



### FLOYD ROSE KIT

Saddles, screws, string blocks and assorted parts for tremolo.  
**HS7100 (13160000).....\$620.40**

### LOCKING NUTS

R1	R2	R4	R5	R6
	HS382	HS384	HS385	HS386
	<b>13120202</b>	<b>13120204</b>	<b>13120205</b>	<b>13120206</b>
HS1381	HS1382	HS1384	HS1385	
<b>13120401</b>	<b>13120402</b>	<b>13120404</b>	<b>13120405</b>	
	HS392			
	<b>13120502</b>			

Chrome.....	\$84.95
Black.....	90.15
Gold.....	96.00

### NUT SIZE

<b>R1</b>	Gibson Flying, "V", Gibson SG type	....1-9/16"
<b>R2</b>	Old Strats, Pacers.....	1-5/8"
<b>R4</b>	B.C. Rich, Gibson Les Paul (Wide String Spacing)	.....1-11/16"
<b>R5</b>	Boogie Body, Charvel.....	1-3/4"
<b>R6</b>	Bullet (New Strats).....	1-9/16"
<b>R7</b>	Bullet (Ibanez Guitar).....	1-5/8"

### REPLACEMENT TREMOLO ARMS

<b>HS362</b>	Chrome (13080200)	.....	\$14.30
<b>HS1362</b>	Black (13080400)	.....	20.15
<b>HS363</b>	Gold (13080500)	.....	23.50
<b>B1C</b>	Chrome, S Style	.....	7.80
<b>WDFIC</b>	Chrome Push-in	.....	12.00
<b>WDFIBK</b>	Black Push-in	.....	13.50
<b>MM1306C</b>	Chrome, FR	.....	8.95
<b>MM1306B</b>	Black, FR	.....	9.95

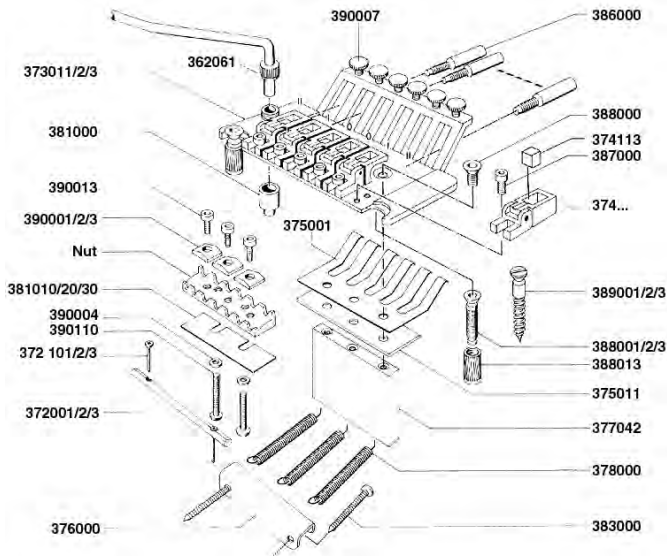

<b>374001</b>	Chrome Saddle #0, G & D	.....	\$13.75
<b>374101</b>	Chrome Saddle #1, A & B	.....	13.50
<b>374201</b>	Chrome Saddle #2, E & E	.....	13.75
<b>374002</b>	Gold Saddle #0, G & D	.....	14.85
<b>374102</b>	Gold Saddle #1, A & B	.....	14.90
<b>374202</b>	Gold Saddle #2, E & E	.....	14.85
<b>374003</b>	Black Saddle #0, G & D	.....	14.85
<b>374103</b>	Black Saddle #1, A & B	.....	14.85
<b>374203</b>	Black Saddle #2, E & E	.....	14.85
<b>389001</b>	Chrome Pivot Screw	.....	7.50
<b>389003</b>	Black Pivot Screw	.....	10.00
<b>372001</b>	Chrome String Retainer	.....	10.00
<b>372003</b>	Black String Retainer	.....	12.00
<b>372101</b>	Chrome S/R Screw	.....	1.40
<b>372102</b>	Gold String Retainer Screw	.....	1.70
<b>372103</b>	Black String Retainer Screw	.....	1.40
<b>374113</b>	String Lock Insert	.....	.70
<b>386060</b>	String Lock Screw Old Style	.....	1.80
<b>387000</b>	Saddle Mtg. Screw	.....	.35
<b>386000</b>	String Lock Screw	.....	1.70
<b>390007</b>	Finetuner Screw	.....	1.85
<b>362061</b>	T-Arm Bushing	.....	3.40
<b>381000</b>	T-Arm Cap Bushing	.....	2.00
<b>381011</b>	.1 mm Nut Spacer	.....	1.10
<b>381021</b>	.2 mm Nut Spacer	.....	1.10
<b>381031</b>	.3 mm Nut Spacer	.....	1.10

<b>375001</b>	Bronze Spring	.....	\$6.80
<b>375011</b>	Shim-Bronze Spring	.....	5.00
<b>377042</b>	Tremolo Block	.....	38.50
<b>376000</b>	Tremolo Claw	.....	5.60
<b>383000</b>	Tremolo Claw Screw	.....	1.10
<b>378000</b>	Tremolo Spring	.....	5.20
<b>388000</b>	Tremolo Block Screw	.....	1.10
<b>390001</b>	Chrome Nut Cap	.....	2.80
<b>390002</b>	Gold Nut Cap	.....	3.70
<b>390003</b>	Black Nut Cap	.....	3.10
<b>390013</b>	Nut Cap Screw	.....	1.10
<b>390110</b>	Nut Mtg. Screw	.....	1.15
<b>390004</b>	Lock Washer	.....	.40
<b>388001</b>	Chrome Stud	.....	6.50
<b>388002</b>	Gold Stud	.....	7.60
<b>388003</b>	Black Stud	.....	6.80
<b>388013</b>	Insert Bushing	.....	2.55
<b>388001/1</b>	Chrome Stud + Insert	.....	7.65
<b>388003/1</b>	Black Stud + Insert	.....	9.20
<b>373011</b>	Chrome Base Plate	.....	51.00
<b>373012</b>	Gold Base Plate	.....	98.85
<b>373013</b>	Black Base Plate	.....	64.00
<b>381010S</b>	1mm Short Spacer	.....	1.10
<b>381020S</b>	2 mm Short Spacer	.....	1.10
<b>381030S</b>	3 mm Short Spacer	.....	1.10

Prices may vary due to Euro/Dollar fluctuation  
[www.schaller-electronic.com](http://www.schaller-electronic.com)

## BIGSBY TAILPIECES AND VIBRAMATE



**B3** Short Body Conventional Model – with end hinge, designed for standard or thin rim hollow body – arched top electric or acoustic guitar.

<b>B3</b>	Chrome	.....	\$238.00
<b>B3G</b>	Gold	.....	348.00
<b>B30</b>	Chrome Die Cast	.....	200.99
<b>B30G</b>	Gold Die Cast	.....	288.99

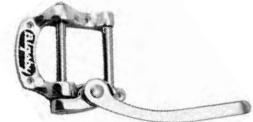

**B-5** Solid Body Style – top mounted – no end hinge, designed for solid body guitar – has string roller to provide string pressure at bridge.

<b>B5</b>	Chrome	.....	\$238.00
<b>B50</b>	Chrome Die Cast	.....	200.99
<b>B50G</b>	Gold Die Cast	.....	288.99
<b>V5</b>	Chrome Vibramate	.....	69.95
<b>V5ST</b>	Chrome Vibramate	.....	69.95
<b>V5G</b>	Gold Vibramate	.....	99.95
<b>V5STG</b>	Gold Vibramate	.....	99.95
<b>V5TEV2S</b>	Chrome 2 Kit Vibramate	.....	119.95



**B-6** Long Body Conventional Model – with end hinge, designed for standard arched top acoustic guitars.

<b>B6</b>	Chrome	.....	\$268.99
<b>B6G</b>	Gold	.....	368.99



**B-7** Semi Solid Style – with end hinge and string pressure roller designed for semi-solid or laminated guitars

<b>B7</b>	Chrome	.....	\$268.99
<b>B7G</b>	Gold	.....	378.99
<b>B70</b>	Chrome Die Cast	.....	227.99
<b>B70G</b>	Gold Die Cast	.....	297.99
<b>V7</b>	Chrome Vibramate	.....	69.95
<b>V7LPG</b>	Gold Vibramate	.....	99.95
<b>B12</b>	Nickel	.....	268.99

**All tailpieces can be ordered without bridge. Add suffix NB to part number.**

### Standard Bigsby Arm

<b>SBA</b>	.....	\$46.00	
<b>VSRI</b>	Chrome Spring Spoiler Vibramate	.....	39.95
<b>VSRI G</b>	Gold Spring Spoiler Vibramate	.....	119.95

Replacement spring, fits all models.

**SPRING** ..... 9.00

Chrome plated tremolo arm with hardware.

**CARM** 7/8" ..... 69.00

### BRIDGES

<b>ABB</b>	Aluminum	.....	\$48.00
<b>GBB</b>	Gold	.....	58.00

**V**The Vibramate V5 Model Quick Mount Kit is designed for a Bigsby B5 Original Vibrato and will fit most traditional style guitars that have a tune-a-matic style bridge and a stop-tailpiece. Eliminates the need for drilling permanent holes in your instrument. The Vibramate Quick Mount Kit includes both English and Metric threaded hardware.

## GUITAR BRIDGES



<b>3343</b>	Rosewood with plastic saddle .....	<b>\$15.00</b>
<b>SF2801</b>	Rosewood .....	<b>11.50</b>
<b>SF2802</b>	Ebony .....	<b>43.00</b>
<b>SF3401</b>	Bone Saddle .....	<b>5.70</b>
<b>WDF6</b>	Rosewood .....	<b>22.05</b>



Hardwood, regular guitar bridge, ebonized, notched, with white plastic saddle or fret. For use on guitar with a tailpiece.

<b>3342</b>	.....	<b>\$5.05</b>
<b>AGBR100</b>	Adjustable Saddle .....	<b>4.40</b>
<b>3380</b>	Hardwood, adjustable saddle .....	<b>19.50</b>
<b>3381</b>	Rosewood, adjustable saddle .....	<b>24.55</b>



<b>3344</b>	.....	<b>\$20.05</b>
-------------	-------	----------------



### ARCH TOP

<b>7919</b>	Ebonized .....	<b>\$16.50</b>
<b>7926</b>	Rosewood .....	<b>18.55</b>



<b>3323</b>	Rosewood .....	<b>\$15.00</b>
-------------	----------------	----------------



<b>WD8603</b>	Rosewood .....	<b>\$20.70</b>
<b>WD8604</b>	Rosewood w/inlay .....	<b>22.05</b>



**12 STRING**  
Rosewood, glue-on or screw-on style bridge.

<b>3378</b>	.....	<b>\$19.50</b>
<b>WDF12</b>	.....	<b>23.25</b>
<b>MM2212</b>	.....	<b>18.95</b>

Rosewood, adjustable style with white plastic saddle across top of bridge.

<b>3379</b>	.....	<b>\$19.95</b>
-------------	-------	----------------



### ARCH TOP

<b>AB152</b>	Ebony .....	<b>\$42.60</b>
<b>AB152T</b>	Ebony, tuno matic.....	<b>88.80</b>

## BANJO BRIDGES

### GROVER LEADER



The Grover "Leader" bridge is an old favorite with banjoists. Made of selected hard maple with ebony top.

Specify Size i.e. 30 1/2

<b>30</b>	Tenor Banjo 1/2" or 5/8" .....	<b>\$6.95</b>
<b>30B</b>	5-String Banjo 1/2" or 5/8" .....	<b>6.95</b>

### GROVER ACOUSTICRAFT



Made of seasoned maple with ebony insert and individual ivoroid blocks.

<b>90</b>	Tenor Banjo, 1/2" high .....	<b>\$13.00</b>
<b>91</b>	Tenor Banjo, 5/8" high .....	<b>13.00</b>
<b>95</b>	5-String Banjo, 1/2" high .....	<b>13.00</b>
<b>96</b>	5-String Banjo, 5/8" high .....	<b>13.00</b>

## MANDOLIN BRIDGES



<b>1990</b>	Rosewood .....	<b>\$ 8.50</b>
<b>1991</b>	Ebony w/insert .....	<b>16.00</b>

### ADJUSTABLE

<b>1992</b>	Ebony .....	<b>\$22.50</b>
<b>SM200</b>	Rosewood .....	<b>13.60</b>
<b>MANDBCR</b>	Rosewood/Chrome.....	<b>35.00</b>
<b>MANDBRGD</b>	Rosewood/Gold.....	<b>40.00</b>

### GROVER NON TIP



Hand fitted with the famous Grover "non-tip" center support. The world's most popular bridge.

Specify Size i.e. 5 1/2

<b>4</b>	5-String Banjo 1/2" or 5/8" .....	<b>\$6.95</b>
<b>5</b>	Tenor Banjo 1/2" or 5/8" .....	<b>6.95</b>

### STEWART-MACDONALD



<b>SM270</b>	5-String Banjo, 5/8" Compensated.....	<b>\$11.15</b>
<b>SM264</b>	5-Stg, Map/Ebo 3/4" .....	<b>6.20</b>
<b>SM265</b>	5-Stg, Map/Ebo 1/2" .....	<b>6.20</b>
<b>SM266</b>	5-Stg, Map/Ebo 5/8" .....	<b>6.20</b>
<b>SM277</b>	5-Stg, Map/Ebo 1 1/16" .....	<b>6.20</b>
<b>SM272</b>	4-Stg, Map/Ebo 5/8" .....	<b>6.20</b>

### GROVER MINSTREL



Popular 3-legged model. Selected maple with ebony strip, wedged in for greater security.

<b>70</b>	Tenor Banjo, 1/2" High .....	<b>\$8.50</b>
<b>71</b>	Tenor Banjo, 5/8" High .....	<b>8.50</b>
<b>72</b>	5-String Banjo 1/2" high .....	<b>8.50</b>
<b>73</b>	5-String Banjo, 5/8" high .....	<b>8.50</b>

### COMPENSATING



Select maple, with a specially shaped compensating ebony top. Gives each string its proper scale.

<b>76</b>	5-String Banjo, 1/2" high (Grover) .....	<b>\$13.95</b>
<b>77</b>	5-String Banjo, 5/8" (Grover) .....	<b>13.95</b>
<b>SGB5</b>	5-String Banjo, 5/8" (Saga) .....	<b>6.85</b>

## FROM OUR MUSIC DEPARTMENT

<b>Leonard Guitar Method Bk. 1</b> .....	<b>\$ 6.99</b>
<b>Leonard Guitar Method Bk. 1, Bk/CD</b> .....	<b>10.95</b>
<b>Leonard Guitar Method Bk. 1, VHS Video</b> .....	<b>14.95</b>
<b>Leonard Guitar Method Bk. 1, DVD Video</b> .....	<b>19.95</b>

# DUNLOP FRET WIRE

## PROFILE OF FRET WIRE

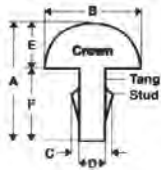

### Applications

- 6230 Fender guitars
- 6130 Gibson guitars ("Jumbo" wire)
- 6230 Martin guitars
- 6000, 6100, 6110 maximum mass
- 6105 maximum height narrower
- 6170 oversize fret slots
- 6280 6290 banjo
- 6110 bass
- 6310 mandolin

PACK: 24 Pcs. - 2 5/8" Cut  
TUBE: 20 - 2 Foot Lengths

SHAPE	FRET NO.	MATERIAL*	A		B		C		D		E		LIST	
			INCH	MM	INCH	MM	INCH	MM	INCH	MM	INCH	MM	PACK	TUBE
Extra High for Rock & Roll	6000	H	.128	3.25	.118	2.99	.036	.91	.021	.53	.058	1.47	\$24.05	\$144.24
	6100	18% N/S H	.125	3.18	.110	2.79	.032	.81	.021	.53	.055	1.40	20.70	124.16
	6105	H	.115	2.92	.090	2.29	.031	.79	.021	.53	.055	1.40	20.70	124.16
	6110	H	.104	2.64	.115	2.92	.036	.91	.020	.51	.050	1.27	20.70	124.16
	6120	H	.116	3.00	.110	2.79	.038	.97	.022	.56	.043	1.09	20.70	124.16
	6130	18% N/S H	.109	2.77	.106	2.69	.036	.91	.020	.51	.036	.91	21.58	129.43
	6140	H	.110	2.79	.105	2.67	.038	.97	.023	.58	.041	1.04	20.44	122.61
	6150	H	.108	2.74	.102	2.59	.031	.79	.020	.51	.042	1.07	18.77	112.59
	6160	S	.111	2.82	.102	2.59	.038	.97	.023	.58	.042	1.07	21.25	127.67
	6170	12% N/S H	.129	3.28	.098	2.49	.048	1.22	.023	.58	.046	1.17	21.25	127.67
	6180	Brass	.101	2.57	.085	2.16	.035	.89	.022	.56	.038	.97	20.06	120.30
	6190	18% N/S H	.096	2.44	.084	2.13	.032	.81	.020	.51	.040	1.02	28.27	169.61
	6200	H	.100	2.54	.084	2.13	.045	1.14	.024	.61	.038	.97	20.06	120.30
	6210	12% N/S H	.100	2.54	.083	2.11	.034	.86	.019	.48	.043	1.09	20.06	120.30
	6220	H	.097	2.47	.082	2.08	.038	.97	.024	.61	.041	1.04	21.45	128.64
	6230	H	.097	2.47	.080	2.03	.037	.94	.020	.51	.043	1.09	23.53	141.12
	6240	H	.091	2.31	.080	2.03	.031	.79	.020	.51	.040	1.02	27.88	167.26
	6250	18% N/S H	.095	2.41	.079	2.01	.035	.89	.020	.51	.035	.89	27.88	167.26
	6260	H	.106	2.69	.079	2.01	.038	.97	.023	.58	.040	1.02	25.72	154.30
	6270	H	.095	2.41	.077	1.96	.032	.81	.020	.51	.034	.86	28.39	170.27
6290	H	.094	2.39	.072	1.83	.032	.81	.020	.51	.032	.81	23.53	141.12	
	6300	12% N/S H	.076	1.93	.065	1.65	.038	.97	.023	.58	.026	.66	23.53	141.12
	6310	H	.090	2.29	.056	1.42	.031	.79	.020	.51	.032	.81	26.42	158.51
	6320	18% N/S H	.083	2.11	.047	1.19	.028	.71	.020	.51	.023	.58	28.39	170.27
6330	H	.078	1.98	.045	1.14	.035	.89	.023	.58	.024	.61	28.35	170.08	
	6340	18% N/S H	.088	2.24	.072	1.83	.033	.84	.020	.51	.035	.89	23.53	

www.jimdunlop.com

## FILES



### NUT FILE

- F18480 .....\$18.95
- HSPLF10 Luthier Set .....19.99
- SM3062 5 Piece Set .....38.20

## HERCO PICKS



### NYLON

- HE210 Flex 50, Gold .....\$43.40/100
- HE210P Flex 50, Gold .....5.55/12
- HE211 Flex 75, Silver .....43.40/100
- HE115 Blue Thumb Flex 52 .....46.70/50

## THUMPER PICKS FOR BASS GUITARS



Thumper custom instrument picks were originally designed for playing bass guitar fast, without the clacking noise of a hard pick or the string-grab of a soft rubber pick. **They can also be used to acquire a unique sound for guitar, dobro, ukulele, and other stringed instruments.**

- THPB Blue .....\$2.40 ea.
- THPBK Black .....2.40 ea.

### CELLULOSE

- HE111 Flat-thumb-thin .....\$44.60/24
- HE112 Flat-thumb-med .....44.60/24
- HE113 Flat-thumb-hvy .....44.60/24
- HE114 Flat-thumb-x-hvy .....44.60/24
- HE112P Flat-thumb-med .....5.55/3
- HE113P Flat-thumb-hvy .....5.55/3

## JIMI HENDRIX



24 tins per display box (6 each of 4 designs), 12 picks per tin.

- JHPT24 .....\$239.40

## FRET REST



Compact, portable guitar work station features a non-skid pad that cushions and protects body and finish of instrument. Designed for electrics or acoustics.

- FRETREST .....\$58.50

## GOLDEN GATE



### Mock Turtle Picks

- SMP12 346 Style, Mandolin .....\$20.95 dz.
- SMP20 Large Triangle (355) .....83.95 dz.
- SMP22 Rounded Triangle (346) .....83.95 dz.
- SMP24 Standard (351) .....83.95 dz.

### Thumb Picks

- SGP5 Pearloid, Med .....\$34.60 dz.
- SGP6 Pearloid, Large .....34.60 dz.
- SGP8 Pearloid, X-Heavy .....47.20 dz.
- SGP7 Multi, Large .....34.60 dz.
- SGP10 Ivoroid, Large .....34.60 dz.
- SGP11 Ivoroid, Medium .....34.60 dz.
- SGP12 Ivoroid, Small .....34.60 dz.

## ORIGINAL PICKS BY THE POUND®



Factory seconds at an affordable price.

- HPP100 100 Assorted .....\$ 18.90
- HPP1000 One Pound (Approx 900) .....110.00

## PICKERS POUCH



Made from genuine leather. The Picker's Pouch will hold picks in a variety of shapes and sizes.

- JD5201 .....\$6.30



## FENDER PICKS



351		358	
351T	Shell/White .....\$37.95/GR	358T	Shell .....\$18.15/72
351M	Shell/White .....37.95/GR	358M	Shell .....18.15/72
351H	Shell/White .....37.95/GR	358H	Shell .....18.15/72
351XH	Shell/White .....37.95/GR		
351T	Confetti .....\$37.95/GR	355	
351M	Confetti .....37.95/GR	355T	Shell .....\$29.70/72
351H	Confetti .....37.95/GR	355M	Shell .....29.70/72
351XH	Confetti .....37.95/GR		
346		355 Shape - Shell (Pack of 12)	
346T	Shell/White .....\$28.00/72	12355TS	Shell .....\$4.95/12
346M	Shell/White .....28.00/72	12355MS	Shell .....4.95/12
346H	Shell/White .....28.00/72	12355HS	Shell .....4.95/12
346XH	Shell/White .....28.00/72		
12346T	Shell/White .....\$4.95/12	<b>FENDER STEEL PICKS</b>	
12346M	Shell/White.....4.95/12	351 Shape (Pack of 4)	
12346H	Shell/White.....4.95/12	S351T Thin .....\$6.60	
		S351M Medium .....6.60	
		S351H Heavy .....6.60	

### EDIE VAN HALEN

#### Signature Picks

**EVH351** 12 Pack.....\$9.90

EVH Premium Guitar picks were hand selected by Eddie from thousands of picks he's used over the years. These nylon picks feature a non-slip surface, the classic EVH logo, and a comfortably rounded tip that's just right for shredding Eddie's licks. EVH Premium Guitar Picks come 12 per pack in a collectible tin that features the EVH logo and images of his famous Frankenstrat.

**Fender® Nylon** picks are made in the USA out of a durable, high quality material with a non-slip molded tactile gripping surface. Available in six different gauges to accommodate any playing style.

<b>12 PACKS</b>	<b>1/2 GROSS (72 PACKS)</b>
12N35146 .....\$4.95	N35146 .....\$24.75
12N35160 .....4.95	N35160 .....24.75
12N35173 .....4.95	N35173 .....24.75
12N35188 .....4.95	N35188 .....24.75
12N351100 .....4.95	N351100 .....24.75
12N351114 .....4.95	N351114 .....24.75

### COLLECTOR SERIES

36 Asst. Picks in a Tin

**0351010** .....\$12.40

The Make History Pick Tin includes 36 of the world's most popular Fender 351 sharp guitar picks: 6 thin gauge, 24 medium gauge and 6 heavy gauge true-celluloid tortoise shell color picks. Each highly-stylized, decorative tin is destined to become an instant collectible to be used over and over again for years to come.

## SHARK TOOTH PICKS

SNCT40	Shark Tooth Kit .....\$11.00/2 pk.
SNCK30	Kodiak Pick Kit .....15.00
SNCK30DB	Kodiak Pick (No Pouch) .....10.95

### MAGIC PICK HEART SHAPE

MPAC	Stone Agate Celtic Cross.....\$9.00
MPAD	Stone Agate Dove .....9.00

## RECORDING KING PICKS

### FINGERPICKS IVOROID

PG633XL	30 pack .....\$20.75
PG633L	30 pack .....18.55
PG633M	30 pack .....15.75
PG633S	30 pack .....14.15

### THUMB PICKS IVOROID

PG623XL	30 pack .....\$21.10
PG623L	30 pack .....19.20
PG623M	30 pack .....17.30
PG623S	30 pack .....15.40

## EVERLY STAR PICKS



Shell/Delrin Material, 351 shape.  
Available In: 50, 60, 73, 88, 100 and 1.14mm  
12 Picks per Pack.

EP	Specify Gauge, Standard.....\$5.90
EPS	Shell Specify Gauge, Standard .....7.05
72EPS	Shell Specify Gauge, Standard, 72/pack .....42.15
72EP	Specify Gauge, Standard, 72/pack ..35.60

## FENDER PICK PACKS

A handy re-sealable pack of 12 celluloid picks

351 Shape - Confetti (Pack of 12)	
12351TC	Thin .....\$4.95
12351MC	Medium.....4.95
12351HC	Heavy .....4.95
12351XHC	Extra Heavy .....4.95

351 Shape - Shell (Pack of 12)

12351TS	Thin .....\$4.95
12351MS	Medium.....4.95
12351HS	Heavy .....4.95
12351XHS	Extra Heavy .....4.95

351 Shape - White (Pack of 12)

12351TW	Thin .....\$4.95
12351MW	Medium.....4.95
12351HW	Heavy .....4.95

351 Shape - White Moto (Pack of 12)

12351TWM	Thin .....\$4.95
12351MWM	Medium.....4.95
12351HWM	Heavy .....4.95

351 Shape - Ocean Turq. (Pack of 12)

12351TOT	Thin .....\$4.95
12351MOT	Medium.....4.95
12351HOT	Heavy .....4.95

351 Shape - Abalone (Pack of 12)

12351TA	Thin .....\$4.95
12351MA	Medium.....4.95
12351HA	Heavy .....4.95

351 Shape - Black Moto (Pack of 12)

12351TBM	Thin .....\$4.95
12351MBM	Medium.....4.95
12351HBM	Heavy .....4.95

A handy re-sealable pack of 12 California Clears

351 Shape - Lake Placid Blue Pk/12	
12351TLPB	Thin.....\$3.75
12351MLPB	Medium.....3.75
12351HLPB	Heavy .....3.75

351 Shape - Candy Apple Red Pk/12

12351TCAR	Thin.....\$3.75
12351MCAR	Medium.....3.75
12351HCAR	Heavy .....3.75

351 Shape - Surf Green Pk/12

12351TSUG	Thin.....\$3.75
12351MSUG	Medium.....3.75
12351HSUG	Heavy .....3.75

351 Shape - Burgundy Mist Pk/12

12351MBUM	Medium.....3.75
-----------	-----------------

351 Shape - Green Moto (Pack of 12)

12351TGM	Thin.....\$4.95
12351MGM	Medium.....4.95
12351HGM	Heavy .....4.95

351 Shape - Purple Moto (Pack of 12)

12351TPM	Thin.....\$4.95
12351MPM	Medium.....4.95
12351HPM	Heavy .....4.95

351 Shape - Red Moto (Pack of 12)

12351TRM	Thin.....\$4.95
12351MRM	Medium.....4.95
12351HRM	Heavy .....4.95

351 Shape - Blue Moto (Pack of 12)

12351TBLM	Thin.....\$4.95
12351MBLM	Medium.....4.95
12351HBLM	Heavy .....4.95

## ROCK ON PICKS

### MADE OF DELRIN

12RO35150.....\$4.95/12	RO35150 .....\$24.75/72
12RO35160.....4.95/12	RO35160 .....24.75/72
12RO35173.....4.95/12	RO35173 .....24.75/72
12RO35188.....4.95/12	RO35188 .....24.75/72
12RO351100.....4.95/12	RO351100 .....24.75/72
12RO351114.....4.95/12	RO351114 .....24.75/72

Available in Red - thin .50mm, Orange - thin/medium .60mm, Yellow - medium .73mm, Green medium/heavy .88mm, Blue - heavy 1.0mm, Purple - heavy/extra heavy 1.14mm.

[www.fender.com](http://www.fender.com)

## MOSHAY NYLON PICKS



The Moshay pick assortment contains 3 styles of picks, (358, 351 & 351 large) in 4 different weights.

**MOSH100** .....\$459.00 gr.  
REFILLS .....36.00 dz.

MOSH101	Red	358	Red-Thin	MOSH107	Blu	358
MOSH102	Red	351	Grn- Med.	MOSH108	Blu	351
MOSH103	Red	351L	Blu-Thick	MOSH109	Blu	351L
MOSH104	Grn	358	Blk-X-Thick	MOSH110	Blk	358
MOSH105	Grn	351		MOSH111	Blk	351
MOSH106	Grn	351L		MOSH112	Blk	351L

## DUNLOP THUMB & FINGER PICKS

### THUMB

9001SM	Wht Small .....\$12.95 dz.
9002MD	Wht Med. ....12.95 dz.
9003LG	Wht Lge. ....14.69 dz.
9013L	Wht Lge., Lefty .....14.69 dz.
9002P	Wht Med .....5.15/4
9003P	Wht Lge .....5.15/4
9022MD	Shell, Med .....12.95 dz.
9023LG	Shell, Lge .....14.69 dz.
9022P	Shell Med .....5.15/4
9023P	Shell Lge .....5.15/4
9051R	Red Med., Delrin ..12.95 dz.



9022MD

### FINGER PICK

9011MD	White, Med.....\$12.95 dz.
9021LG	White, Lge .....14.69 dz.
9010MD	Shell.....12.95 dz.
9020LG	Shell.....14.69 dz.

3 finger, 1 thumb

9010TP	Medium .....\$5.15
9020TP	Large .....5.15

## D'ANDREA IMPRINTED PICKS

### CLASSIC CELLULOID

6 gauges: Thin, T/Med, Med, Med. Hvy, Heavy, X-Hvy.  
Colors: Shell, White, Black, Multi  
Imprint: Black, White, Gold, Silver, Red, Blue.  
Minimum: 15 Bags 100 Picks/Bag  
346, 355, 358 style available at extra charge.

<b>DANLOGO</b> .....	<b>\$60.00 NET</b>
<b>DANIMP</b> .....	<b>52.50/Pk</b>
<b>DLUXIMP</b> DLux Celluloid.....	<b>52.50</b>
<b>DANFBI</b> 1500 in Fish Bowl.....	<b>638.25</b>
<b>DANFBIA</b> 1500 DLux Celluloid.....	<b>638.25</b>

### Brites

6 gauges: Thin, T/Med, Med, Med. Hvy, Heavy, X-Hvy.  
Colors: Red, Orange, Yellow, Green, Pink, Violet.  
Imprint: Black or White.  
Minimum: 15 Bags 100 Picks/Bag

<b>DANLOGO</b> .....	<b>\$60.00 NET</b>
<b>BRTEIMP</b> .....	<b>39.00</b>
<b>DANFB3</b> 1500 in Fish Bowl.....	<b>540.00</b>

### DELREX

6 gauges: Thin, T/Med, Med, Med. Hvy, Heavy, X-Hvy.  
Colors: Red, Orange, Yellow, Green, Blue, Purple.  
Imprint: Black or White.  
Minimum: 15 Bags 100 Picks/Bag

<b>DANLOGO</b> .....	<b>\$60.00 NET</b>
<b>DELREXIMP</b> .....	<b>39.00</b>
<b>DANFB2</b> 1500 in Fish Bowl.....	<b>540.00</b>

### V RESIN

3 gauges: Thin, Med, Heavy.  
Colors: White, Black, Red, Pink, Lt. Blue, Trans. Blue, Yellow.  
Imprint: Black, White, Gold, Silver, Red, Blue.  
Minimum: 15 Bags 100 Picks/Bag

<b>DANLOGO</b> .....	<b>\$60.00 NET</b>
<b>VRESINIMP</b> .....	<b>31.80</b>
<b>DANFB5</b> 1500 in Fish Bowl.....	<b>405.00</b>
<b>DANFB5A</b> 1500 in Fish Bowl, Transparent .....	<b>405.00</b>

## DUNLOP IMPRINTED PICKS

Low Minimum order of only  
800 picks (4 bags)  
200 picks per bag

Three Gauges Light = .46mm,  
Medium = .71mm, Heavy = .96mm  
Three Lines of Print Maximum  
ten (10) Characters/spaces per

Your Choice of colors: White, Lt Pink, Dk Pink, Magenta, Red, Maroon, Orange, Yellow, Green, Blue, Lavender, Purple, Cream, Tan, Brown, Dark Brown, Medium Gray, Black.

### DELIN PICKS

<b>DUNLOGO</b> Logo Charge.....	<b>\$50.00 NET</b>
<b>DUNIMP</b> .....	<b>50.20/Bag</b>
<b>DUNBLOCK</b> Set Up Charge.....	<b>30.00</b>

**TORTEX** Picks imprinted with your store name, group or players name. Personalized picks.

<b>TORIMP</b> .....	<b>\$71.10/Bag</b>
<b>DUNBLOCK</b> .....	<b>30.00</b>

### GATOR GRIP PICKS

<b>GATIMP</b> .....	<b>\$71.10/Bag</b>
---------------------	--------------------

<b>486CIMP</b> Gel Picks .....	<b>\$50.20/Bag</b>
<b>CELIMP</b> Celluloid Picks .....	<b>76.20/Bag</b>
<b>SHEIMP</b> Shell Picks.....	<b>76.20/Bag</b>

## WEDGIE PICKS



<b>DELIN</b>	
<b>WDPP</b> .....	<b>\$4.80/12</b>
.50 .60 .73 .88 .100-114	
<b>CLEAR</b>	
<b>WCPP</b> .....	<b>4.80/12</b>
.50 .60 .73 .88 .100-114	
<b>NYLON</b>	
<b>WNPP</b> .....	<b>4.80/12</b>
.40 .50 .60 .73 .88 .100	
<b>RUBBER</b>	
<b>WRPP50</b> .....	<b>2.25/3</b>
S, M, H, 5.0	
<b>WRPP31</b> .....	<b>2.25/3</b>
S, M, H, 3.1	

## GORILLA SNOT



Increases grip on picks,  
sticks, etc.  
**KONG** .....**\$7.95**

## ERNIE BALL PICKS



<b>EB9201</b>	Assortment .....	<b>\$38.00 gr.</b>
<b>EB9101</b>	Thin White .....	<b>\$26.00 gr.</b>
<b>EB9102</b>	Shell Color	
<b>EB9103</b>	Psycho Red	
<b>EB9105</b>	Slinky Pink	
<b>EB9106</b>	Blue	
<b>EB9108</b>	Assorted	
<b>EB9111</b>	Med. White .....	<b>\$34.00 gr.</b>
<b>EB9112</b>	Shell Color	
<b>EB9113</b>	Psycho Red	
<b>EB9115</b>	Slinky Pink	
<b>EB9116</b>	Blue	
<b>EB9118</b>	Assorted	
<b>EB9121</b>	Stiff White .....	<b>\$44.00 gr.</b>
<b>EB9122</b>	Shell Color	
<b>EB9128</b>	Assorted	

### PICK PACKS - 24 PER PACK

<b>EB9170</b>	Thin Assorted .....	<b>\$6.00</b>
<b>EB9172</b>	Med. Assorted .....	<b>6.00</b>
<b>EB9174</b>	Stiff Assorted.....	<b>6.00</b>



### PICK PACKS - 12 PER PACK

<b>PO9176</b>	Thin Celluloid .....	<b>\$3.25</b>
<b>PO9178</b>	Med. Celluloid .....	<b>3.25</b>
<b>PO9180</b>	Heavy Celluloid .....	<b>3.25</b>
<b>PO9135</b>	Thin Nylon .....	<b>\$4.25</b>
<b>PO9136</b>	Med. Nylon .....	<b>4.25</b>
<b>PO9137</b>	Heavy Nylon .....	<b>4.25</b>
<b>PO9221</b>	Thin Camouflage Celluloid.....	<b>\$4.50</b>
<b>PO9222</b>	Med. Camouflage Celluloid.....	<b>4.50</b>
<b>PO9223</b>	Heavy Camouflage Celluloid.....	<b>4.75</b>
<b>PO9224</b>	Thin Fluorescent Celluloid .....	<b>\$4.50</b>
<b>PO9225</b>	Med. Fluorescent Celluloid .....	<b>4.50</b>
<b>PO9226</b>	Heavy Fluorescent Celluloid .....	<b>4.75</b>



<b>EB9220</b>	Metal finger picks.....	<b>\$31.00/24</b>
<b>EB9210</b>	Plastic thumb picks, Medium .....	<b>14.75/24</b>
<b>EB9213</b>	Plastic thumb picks, Large .....	<b>14.75/24</b>
<b>PO9215</b>	Plastic thumb picks, Medium .....	<b>4.00/6</b>
<b>PO9216</b>	Plastic thumb picks, Lge .....	<b>4.00/6</b>

## WABASH PICKS



<b>13860</b>	Medium/Thln .....	<b>\$53.20/Gr.</b>
--------------	-------------------	--------------------

## FELT PICKS



2553

Specially processed, white hard felt, beveled point.

<b>2553</b>	Oval Style.....	<b>\$22.20 dz</b>
<b>2554</b>	351 Style .....	<b>22.20 dz</b>
<b>62G</b>	Grey Felt .....	<b>23.40 dz</b>
<b>8011</b>	Nick Lucas.....	<b>17.17 dz</b>
<b>8012</b>	Standard.....	<b>17.17 dz</b>

## NATIONAL PICKS



### WHITE

<b>NP7</b>	Thumb pick - medium .....	<b>\$16.90 dz.</b>
<b>NP8</b>	Thumb pick - large.....	<b>18.10 dz.</b>
<b>NP1</b>	Fingerpick - Nickel plated .....	<b>26.57 dz.</b>
<b>NP2</b>	Fingerpick - Original, Metal.....	<b>48.86 dz.</b>

### SHELL, THUMB

<b>NP7T</b>	Medium .....	<b>\$22.00 dz.</b>
<b>NP8T</b>	Large .....	<b>22.00 dz.</b>

### METAL, FINGER

<b>NP2S</b>	Silver .....	<b>\$16.31/4</b>
<b>NP2B</b>	Brass.....	<b>16.31/4</b>
<b>NP2G</b>	Gold .....	<b>29.59/2</b>

# D'ANDREA PICKS / GRAPH TECH PICKS



## Custom Gauged Classic Celluloid

Widest gauge selection in the classic celluloid pick material. Closest in sound and feel to real Tortise Shell

6 Shell gauges  
.46mm, .58mm, .71mm, .84mm,  
.96mm, 1.21mm

**RG351** Refills 72 pcs., poly bags – specify gauge .....**\$20.85**  
i.e. 58RG351 = .58RG35 Picks



## HOLOGRAPHICS

Glowing prismatic 3-D patterns. Available in assorted patterns and heavy gauge.

**HO351** Box of 72 .....**\$28.35**



## TATS

Tattoo art on glow-in-the dark Delrin. Available in assorted patterns. Choice of **thin, medium, heavy** or **extra-heavy**.

**TTAT351** Bag of 12, Med.....**\$6.00**  
**TAT351** Box of 72 .....**\$35.10**

## THUMB/FINGER PICKS



## PLASTIC

**2012AT** Thumb picks, 1/2 gro., Asst .....**\$112.50**  
**2012AF** Finger picks, 1/2 gro., Asst.....**112.50**

## COOL PLEC'S SAMPLER

Raised counter display. 18 compartments in six assortments  
**CPK1** 216 picks .....**\$126.00**



## PRO PLECTS

All extra-heavy 1.5mm gauge shell.

Boxed 12 pcs.

**Pro 346** Rounded Triangle .....**\$14.15**  
**Pro 351** Standard .....**14.15**  
**Pro 354** Small Teardrop .....**14.15**  
**Pro 358** Small Pointed Teardrop.....**14.15**  
**Pro 310** Large Rounded Teardrop.....**14.15**  
**PRO330** Pointed .....**14.15**

## BRAIN PICKS



## BRAIN PICKS

Gauges:  
.53 (Green) .60 (Purple) .73 (Red)  
.88 (Black) .100 (Grey) 1.14 (Orange)

**SDB351** Picks Kit – 432 pc .....**\$256.65**  
**RSDB351** 72 pc / Specify Gauge.....**43.20**  
**TSD351** 12 Picks – Specify Gauge .....**7.70**  
i.e. 53TSD351 = .53 Green Picks



## ASSORTED CROSS, FISH & DOVE DESIGNS CHRISTIAN PICKS

Choose black or white and choose thin, medium or heavy.

**CP** Box of 72 .....**\$28.35**  
**TCP23MD** Bag of 12 BK & W .....**6.70**  
**RCR351M** Cross (50) .....**32.25**

[www.dandreadpicks.com](http://www.dandreadpicks.com)

## GRAPH TECH PICKS



## TUSQ PICKS

**PQP0068V6** 0.68mm Vintage White, 6 pack .....**\$5.95**  
**PQP0088V6** 0.88mm Vintage White, 6 pack .....**5.95**  
**PQP0100V6** 1.00mm Vintage White, 6 pack .....**5.95**  
**PQP0068V72** 0.68mm Vintage White, 72 pack .....**56.95**  
**PQP0088V72** 0.88mm Vintage White, 72 pack .....**56.95**  
**PQP0100V72** 1.00mm Vintage White, 72 pack .....**56.95**  
**PQP0068B72** 0.68mm Black, 72 pack .....**56.95**  
**PQP0100B72** 1.00mm Black, 72 pack .....**56.95**  
**PQP0068W6** 0.68mm White, 6 pack .....**5.95**  
**PQP0088W6** 0.88mm White, 6 pack .....**5.95**  
**PQP0100W6** 1.00mm White, 6 pack .....**5.95**  
**PQP0068W72** 0.68mm White, 72 pack .....**56.95**  
**PQP0088W72** 0.88mm White, 72 pack .....**56.95**  
**PQP0100W72** 1.00mm White, 72 pack .....**56.95**



## PRO GRIP BRITES NON-SLIP SURFACE

Six fluorescent color gauges  
**PGB351** 6 color gauges 360 picks.....**\$125.00**  
.50mm (Rocket Red), .60mm (Electric Orange)  
.73mm (Arc Yellow), .88mm (Neon Green),  
1.0mm (Shocking Pink), 1.21mm (Ultra-Violet)

**RPGB351** Refills 60 pc. poly bags specify gauge .....**20.85**  
i.e. RPGB351G = .88 Gauge Picks



## ROCK GRAPHICS

**RO351** Box of 72, Hvy .....**\$28.35**

## DELREX SUREGRIP

6 Color gauges  
.50mm (Red), .60mm (Orange), .73mm (Yellow),  
.88mm (Green), 1.0mm (Blue), 1.21mm (Purple)

Delrex Refills 72 pc. poly bag  
**RD351** Standard.....**\$20.85**

## D'ADDARIO/ PLANET WAVES



## PICK HOLDER WITH LED LIGHT

Holds up to 4 medium gauge (.71mm) pick, bright blue LED light illuminates dark settings, keychain design keeps picks on hand, runs on 2 CR1616 3V batteries (included).  
**PWLED01** .....**\$8.99**

## PICK CLIPS



Designed to snap onto the upper part of a microphone stand.

**5010** Dunlop, 7" .....**\$6.15**  
**5012** Dunlop, 12" .....**8.10**  
**5015** Dunlop, holds slide too .....**8.10**  
**PH1** Dandrea .....**7.20**

**WEDGE**  
**WPH001** Guitar .....**\$2.50**

**PEAVY**  
**0044110** .....**\$7.19B**  
Rubber pick holder with six holographic picks

## PICK HOLDERS



**5001** 60 Black .....**\$107.06**  
**5000** 24 Assorted .....**45.54**  
**5005** Black .....**2.26 ea.**  
**5006** Ergo Pickholder .....**\$2.80**  
**5006J** Ergo Pickholder – 24 Jar.....**49.29**

## PICKERS POUCH



Made from genuine leather. The Picker's Pouch will hold picks in a variety of shapes and sizes.  
**JD5201** .....**\$6.30**



# DUNLOP PICKS

## BLACKLINE



- BL100** Blackline Cabinet  
432 picks.....\$286.76  
24 each of 6 images in 3  
gauges: .60, .73, 1.0mm.  
36 picks  
- Specify gauge
- BL01R** Flame Ape .....\$22.16  
**BL02R** Skull 13.....22.16  
**BL03R** Dagger Snake.....22.16  
**BL04R** Chief.....22.16  
**BL05R** Cat 13.....22.16  
**BL06R** Rocket Man.....22.16  
**BL100P** Pack 6, Specify gauge....4.53

## HETFIELDS BLACK FANG ULTEX

- PH1120** Black Fang Cabinet, 108  
picks, 36 each gauge \$75.74  
Specify gauge: 73, 94, 114
- PH112R** Refill (36).....25.25  
**PH112P** Pack (6).....5.67  
**PH112T** Tin (6).....6.65

## POLYS



- STANDARD**  
Refill Bag/72
- BLU479RL** Light.....\$22.85  
**RED479RML** Med. Light.....22.85  
**YEL479RM** Medium.....22.85  
**WHI479RH** Heavy.....22.85  
**BLK479RXH** Ex. Heavy.....22.85

## MAX GRIP



The Max-Grip™ Nylon Pick's molded gripping surface features a carefully engineered coarse grid that provides an unparalleled non-slip surface. The combination of Max-Grip™ and molded nylon material makes this the perfect pick for speed pickers and hard strummers. Gauges .60, .73 and .88 mm feature a rounded tip perfect for strumming, and 1.0, 1.14 and 1.5 mm a sharper tip for better control in lead work.

- 4491** Nylon Max-Grip  
Standard, 216/Cab .....\$88.65
- 449P** Nylon Max-Grip  
Standard, 12/PlyPk.....5.82
- 449R** Nylon Max-Grip  
Standard, 72/Bag .....29.66

## MAX GRIP JAZZ III

- 471P3** Nylon Max-Grip  
Jazz III, 6/PlyPk.....\$ 4.47
- 471R3** Nylon Max-Grip  
Jazz III, 24/Bag.....15.71  
(N) Red, (S) Black
- 471P3C** Nylon Max-Grip Jazz III,  
Carbon Fiber, 6/PlyPk.....5.09
- 471R3C** Nylon Max-Grip Jazz III,  
Carbon Fiber, 24/Bag ...17.96

## HEAVIES THUMB PICKS



- 9205** Med. Ivoroid.....\$19.12/dz  
**9206** Lge. Ivoroid.....19.12/dz  
**9215** Med. Calico.....19.12/dz  
**9216** Lge. Calico.....19.12/dz

## ZOOKIES THUMB PICKS



- Z9000** Cabinet/144 picks...\$138.42  
Refill bags/12 picks. Avail-  
able in Med. or Lge. **Specify**  
**angle (10°, 20°, 30°) and**  
**size.**
- Z9002M** Med.....\$23.56  
**Z9003L** Lge.....23.56

## REV WILLY'S PICK TINS



- RWT01L** Light 6/Tin.....\$7.65  
**RWT02M** Medium 6/Tin.....7.65  
**RWT03H** Heavy 6/Tin.....7.65

## AMERICANA™

Perfect for "tremelo" picking for man-  
dolin and flatpicking stylists.

**494P101** Round Tri, Player's Pack,  
3 picks .....\$8.42/pk.

**494P102** Large Tri, Player's Pack,  
3 picks.....8.42/pk.

## GEL



- Eyecatching Standard Shape Colorful  
Picks.
- 4861** Cabinet, 432 Rcks .....\$128.70  
**4860** 1008 Picks .....236.30  
L (Blue), ML (Green), M  
(Purple),  
H (Red), XH (Yellow)
- 486P** Specify gauge.....\$4.40 dz.  
**486R** Specify gauge.....22.40/72  
**LT, ML, MD, HV, XH**

## SHELL CLASSICS



Made of genuine celluloid

- 483P** 6 Picks, Specify Gauge...\$5.82  
**483RT** Lite, 72/Bag.....32.07  
**483RM** Med, 72/Bag.....32.07  
**483RH** Heavy, 72/Bag.....32.07  
**483RXH** X Heavy, 72/Bag .....32.07

## ULTEX



Ultex material telegraphs the  
slightest contact

- 4210** Cabinet, 144 Picks.....\$79.78  
Gauges: .60, .73, 1.00, 1.14
- 421R** Specify Gauge, 72 Pack...\$39.91  
**421P** Specify Gauge, 6 Pack.....4.47

## ULTEX TRI



Enjoy all the benefits of Ultex in a  
larger, triangular shape.

- 4260** Cabinet / 180  
(36 each gauge) .....\$99.58
- 426R** Refill Bag / 72 picks.....\$39.91
- 426P** Player's Pack / 6 picks.....4.47  
Gauges (mm): .60, .73, .88, 1.0mm  
*Specify gauge when ordering*

## ULTEX JAZZ III



Ultex with the coveted pointed tip  
design and quick release edge of a  
Jazz III.

- 427R** Refill Bag / 24 picks.....\$15.71  
**427P** Player's Pack / 6 picks.....4.47

## ULTEX JAZZ III XL



Ultex with the coveted pointed tip  
design and quick release edge of a  
Jazz III XL.

- 427RXL** Refill Bag/24 Picks .....15.71  
**427PXL** Refill Bag/6 Picks.....4.47

## ULTEX SHARP



Ultex® Sharp has a rigid body that  
tapers into a thinner, sculpted tip for  
greater control and speed.

- 4330** Cabinet, 216 picks .....\$119.60  
**433R** Refill bag / 72 picks.....\$39.91  
**433P** Playres pack / 6 picks.....4.47

*Specify gauge when ordering*  
73, 90, 100, 1.14, 1.40, 2.00

## PRIMETONE ULTEX

Hand burnished sculpted edges.  
**Made from Ultex.** Available in three  
different shapes with a low-profile  
grip or a smooth traditional surface.

- 510R** Refill/12 Picks Std.  
w/Grip .....29.98
- 510P** Refill/3 Picks Std.  
w/Grip.....8.42
- 511R** Refill/12 Picks  
Standard.....29.98
- 511P** Refill/3 Picks  
Standard.....8.42
- Specify gauge:*  
.73, .88, .96, 1.00, 1.30, 1.50

- 512R** Refill/12 Picks  
Tri/w/Grip.....29.98
- 512P** Refill/3 Picks Tri/w/Grip...8.42
- 513R** Refill/12 Picks Triangle...29.98
- 513P** Refill/3 Picks Triangle.....8.42  
*Specify gauge: 1.40, 1.50*

- 514R** Refill/12 Picks  
Semi Round w/Grip.....29.98
- 514P** Refill/3 Picks  
Semi Round w/Grip .....8.42
- 515R** Refill/12 Picks  
Semi Round.....29.98
- 515P** Refill/3 Picks  
Semi Round .....8.42  
1.30 gauge only

## PRIMETONE



Primetone Picks are **molded of bright  
and durable polycarbonate** with a  
built-in concave and carved gripping  
surface.

- 4771** Compact Cabinet  
60 picks.....\$151.53  
**3mm Tips: 304 - round, 305  
- pointed, 306 - medium,  
307 - large round, 308 -  
large pointed**
- 477R** Refill Bag / 6,  
Specify Tip .....16.01  
**5mm Tips: 504 - round, 505  
- pointed, 506 - medium,  
507 - large round, 508 -  
large pointed**
- 477P** Player's Pack / 3 picks,  
Specify Tip .....8.42

# DUNLOP PICKS

## TORTEX



### STANDARD

- 4181** Cabinet/216 picks.....**\$90.36**  
 .50 (Red), .60 (Orange), .73 (Yellow), .88 (Green), 1.0 (Blue), 1.14mm (Purple)
- 418R** Bag/72, Specify Gauge.....**30.37**
- 418P** Bag/12, Specify Gauge.....**5.82**



### PITCH BLACK

- 4880** Cabinet/432 picks.....**\$175.60**  
 Pitch Black. Extra grip processed black finish. .50, .60, .73, .88, 1.0, 1.14mm.
- 488R** Bag/72, Specify Gauge.....**30.37**
- 488P** Bag/12, Specify Gauge.....**5.82**



### TORTEX PITCH BLACK JAZZ III

- 4820** Cabinet/432 Pick.....**175.60**
- 482R** Refill/72 Picks.....**30.37**
- 482P** Refill/12 Picks.....**5.82**  
 .50, .60, .73, .88, 1.0, 1.14, 1.35, 1.50  
 Specify gauge

### TORTEX WHITE JAZZ III

- 4781** Cabinet/432 Picks.....**175.60**
- 478R** Refill/72 Picks.....**30.37**
- 478P** Refill/12 Picks.....**5.82**  
 .73, .88, 1.0, 1.14, 1.35, 1.50  
 Specify gauge

## RIFFS

Low-cost nylon plectra with a great gripping surface. With four gauges in .46, .60, .73, .96, fluorescent colors, the display bowl can be the center of attention on your counter.

- 4350** 576 Picks (4GRO).....**\$123.07**



### FINS

- 4141** Cabinet/216 picks.....**\$88.60**  
 .50 (Red), .60 (Orange), .73 (Yellow), .88 (Green), 1.0 (Blue), 1.14mm (Purple).
- 414R** Bag/72, Specify Gauge ..**\$29.80**



### TEAR DROP

- 4131** Cabinet/216 picks.....**\$90.36**  
 .50 (Red), .60 (Orange), .73 (Yellow), .88 (Green), 1.0 (Blue), 1.14mm (Purple).
- 413R** Bag/72, Specify Gauge.....**30.37**



### TRIANGLE

- 4310** Cabinet/216 picks.....**\$90.36**  
 .50 (Red), .60 (Orange), .73 (Yellow), .88 (Green), 1.0 (Blue), 1.14mm (Purple).
- 431R** Bag/72, Specify Gauge.....**30.37**
- 431P** Bag/6.....**4.31**



### TORTEX SHARP

Tortex® is now available Razor "SHARP" for ultra-high picking accuracy. Available in .73, .88, 1.0, 1.14, 1.35, 1.5mm gauges.

- 4121** Cabinet containing 216 picks, 36 each of all gauges.....**\$90.36**
- 412R** (Specify Gauge) Tortex® Sharp refill bag/72.....**30.37**
- 412P** Bag/12.....**5.82**

### TORTEX JAZZ

- 4720** Cabinet/216 picks.....**\$90.36**  
 2 tip styles (1 – round; 3 – sharp),  
 L (Red), M (Green), H (Purple).
- 472R** Refill Bag/36, Specify Gauge.....**15.71**



### TORTEX JAZZ III XL

- 4981** Cabinet/432 Picks.....**175.60**
- 498R** Refill/72 Picks.....**30.37**
- 498P** Refill/12 Picks.....**5.82**  
 (White) .73, (Yellow) .88, (Green) 1.00, (Blue) 1.14, (Purple) 1.35, (Black) 1.50

### TORTEX SMALL TEARDROP



- 4231** Cabinet/216 Picks.....**\$90.36**  
 .50 (Red), .60 (Orange), .73 (Yellow), .88 (Green), 1.0 (Blue), 1.14mm (Purple).
- 423R** Bag/36 Specify Gauge.....**15.71**



### TORTEX WEDGE

- Wedge shaped Tortex Picks
- 4240** Cabinet, 216 Picks.....**\$90.36**  
 Gauges: .50, .60, .73, .88, .100, 1.14
- 424R** Specify Gauge, 72 Pack.....**30.37**
- 424P** Specify Gauge, 12 Pack.....**5.82**

## TORTEX T III



- 4620** Cabinet/216 Picks.....**\$90.63**  
 Gauges: .50, .60, .73, .88, 1.00, 1.14, 1.35, 1.50
- 462R** Specify Gauge, 72 Pack.....**30.37**
- 462P** Specify Gauge, 12 Pack.....**5.82**

## STUBBY



Contoured for smooth release, these picks provide an extremely positive attack. Manufactured from Lexan.

- 4760** Stubby & Big Stubby Cabinet/216 picks 36 of each gauge and size.....**\$159.53**

- Gauges (mm)/colors:** 1.0 Red, 2.0 Lt. Purple, 3.0 Dk. Purple
- 4740** Cabinet/144 picks.....**\$102.98**  
 1.0, 2.0, 3.0mm.
- 474R** Bag/24, Specify Gauge.....**17.39**
- 474P** Bag/6, Specify Gauge.....**5.15**



- 4750** Big Stubby Cabinet/144 picks. 48 of each gauge.....**\$102.98**
- 475R** Big Stubby Refill Bag/24 picks. (Specify Gauge).....**18.09**
- 475P** Big Stubby Refill Bag /6 Picks (Specify Gauge).....**5.18**
- 473R** Tri Stubby Refill Bag/24 Picks.....**18.09**
- 473P** Tri Stubby Refill Bag/6 Picks.....**5.18**

### NYLON BIG STUBBY

- 4450** Cabinet/144 Picks.....**\$102.98**  
 1.00, 2.00, 3.00
- 445R** Bag 24, Specify Gauge.....**17.39**
- 445P** 6 Pack, Specify Gauge.....**5.15**

## DELRIN



- 4100** Cabinet/324 picks.....**\$98.55**  
 Delrin "500" picks for guitar and bass. .46 (Lt. Pink), .71 (Pink), .96 (Dk. Pink), 1.14 (Magenta), 1.5 (Lavender), 2.0mm (Purple).

- 41R** Bag/72, Specify Gauge...**\$22.85**
- 41P** Bag/12, Specify Gauge.....**4.47**

## FRANK KOZIK



### TORTEX STANDARD

- Gauges: .60, .73, 1.0mm  
 Designs: Devil Bunny (23), El Chingon (24), Bong Buddy (25), Anger Management Issues (26), Classic (27), King of Rock (28)
- BL#R** Bag/36 Specify Gauge and Design.....**\$22.16**
- BL109P** Pack/6 picks, Specify Gauge.....**4.53**

## THUMB/FINGERPICK ASSORTMENT



- 3090** Cabinet containing the most in demand Dunlop Metal and Plastic Finger and Thumbpicks. (Total of 216 picks.).....**\$227.39**

### PLASTIC PICK PACKS

- 3 finger, 1 thumb
- 9010TP** Medium.....**\$5.15**
- 9020TP** Large.....**5.15**



Clear plastic "D" style.

### FINGER

- 9032M** Medium.....**\$12.95 dz.**
- 9033L** Large.....**14.69 dz.**

### THUMB

- 9035M** Medium.....**\$12.95 dz.**
- 9036L** Large.....**14.69 dz.**

## METAL FINGERPICKS



### NICKEL SILVER

- 3020** Cabinet/120 picks.....**\$151.37**  
 .013, .015, .018, .020, .0225, .025 In.
- 33R** Tube/20, Specify Gauge.....**26.61**
- 3060** Cabinet/120 picks.....**151.37**  
 "Mini" picks. .013, .015, .018, .020, .0225, .025 in.
- 36R** Tube/20, Specify Gauge.....**26.61**
- HMF12** Picks by Pound.....**10.80/dz.**

### BRASS

- 3070** Cabinet/120 picks.....**\$151.37**  
 .013, .015, .018, .020, .0225, .025in.
- 37R** Refill Tube/20.....**26.61**  
 Specify Gauge

## METAL THUMB PICKS



### NICKEL SILVER

- 3040T** .025 in., Box/50.....**\$68.02**
- 3040TLS** .025 in., Box/20.....**27.95**  
 Left hand.
- HMT12** Picks by pound.....**10.80/dz.**

# DUNLOP PICKS

## NYLON

One of the miracle materials in pick technology. Dunlop Nylon picks are formulated to last longer.



### STANDARD

- 4420** Cablnet/432 picks .....\$164.99
- 4410** As above, 216 picks .....**88.65**
- 44R** Bag/72, Specify Gauge.... **29.66**
- 44P** Bag/12, Specify Gauge ..... **5.82**  
.38 (White), .46 (Shaded White), .60 (Lt. Gray), .73 (Gray), .88 (Dk. Gray), 1.0 (Black).

### MIDI STANDARD

- 443R** Bag/72, Specify Gauge ..\$31.04  
.53 (Red), .67 (Orange), .80 (Yellow), .94 (Green), .107 (Blue), .114 (Purple).

## VARIETY PACK

- PVP101** Player's Pack ....**5.94/12 pk.**
- PVP102** Player's Pack ....**5.94/12 pk.**



### JAZZ III

- 4700** Cabinet/144 picks.....**\$90.00**  
Nylon (N) and Nylon w/Stiffo (S) picks. 3 tip styles:  
1 - round; 2 - semi-sharp;  
3 - sharp.  
1N - 1.10mm (Red)  
2N - 1.18mm (Red)  
3N - 1.38mm (Red)  
1S - 1.10mm (Black)  
2S - 1.18mm (Black)  
3S - 1.38mm (Black)
- 47R** Bag/24 Specify Gauge ....**\$15.71**
- 47P** Bag/6 Specify Gauge .....**4.47**

## JAZZTONE

Developed specifically for the Jazz guitarist, these picks deliver great tone and speed.



- 4770** Jazztone Cabinet (180 Picks) .....**\$102.98**
- 477R** (Specify Model No.)  
Refill Bag/36 picks .....**21.18**
- 477P** Bag/6 .....**4.28**
- 477R204** Round      **477R206** Med
- 477R205** Pointed   **477R207** Lg Rd.
- 477R208** Lg. Ptd.

### Nylon Fins



- Gauge (mm)/colors:** .42 White, .53 Cream, .67 Lt. Gray, .80 Gray, .94 Dk. Gray, 1.07 Black
- 4440** Cabinet/216 picks  
36 each of all gauges.....**\$93.41**
- 444R** Refill Bag/72 picks.  
(Specify Gauge).....**31.04**

## GLOW PICKS



- 4461** Cabinet/216 picks .....**\$96.17**  
Nylon picks that glow in the dark. Featuring an aggressive non-slip pattern designed into the gripping surface. .67, .80, 1.14 mm - Phosphorescent Green.
- 446R** Bag/72, Spec. Gauge.....**\$33.42**

## STAINLESS STEEL



Highly polished steel.

- STANDARD & ELLIPTICAL TRIANGLE**  
.20, .38, .51 mm. Gauge
- 46RF** Bag/36, Standard .....**\$43.64**

## JAZZ III XL



- More pick to hang on to! Made to spec incorporating the original Jim Dunlop Nylon Jazz III tip.
- Shape/gauge: sharp/1.38  
Red Nylon (N) or Black Stiffo Nylon (S)
- 47RXL** Bag/24,  
Specify Material .....**\$15.71**
- 47PXL** Bag/6.....**4.47**

## ERIC JOHNSON CLASSIC JAZZ III



A Jazz III with an even, more refined and smooth tip, more flexibility.

- 47PEJ3N** 6 Pack.....**\$5.63**

## SPEEDPICK



5 different weights, sizes, and angles in black Delrin.

- 1010** Cabinet, (1 Gross) .....**\$92.38**
- REFILLS**.....**\$15.71/24**
- M10** Standard, 71mm
- H10** Standard, 96mm
- M10R** Standard, 84mm,  
Reverse Angle
- M10J** Jazz, 71mm
- H10J** Jazz, 96mm

## CELLULOID



### STANDARD

- 4830#** Cabinet - 432 picks  
Specify Color #.....**\$190.21**  
144 each of Medium & Heavy,  
72 ea. of other Gauges.

Gauges: Thin, Medium, Heavy, X-Heavy  
Colors: White (01); Black Perloid (02); Black (03); White Perloid (04); Shell (05); Confetti (06)

- 483R** Bag/72 Specify  
Color # and Gauge .....**32.07**
- 483P** Pack/12 Specify  
Color # and Gauge .....**5.82**

## TECK PICK



Aluminum picks with perforated grip. Available in blue (BLU), red, black (BLK), aluminum (CLR), brass (BRS), and textured aluminum (TEX).

- 4670** 72 Pick Display  
Cabinet.....**\$121.70**
- 467R** Refill Bag 12 Picks.....**22.07**

## GATOR GRIP



With Jim Dunlop's Gator Grip™ Picks, it's easy to get a grip and keep it!

- 4170**.....**\$146.26**  
Cabinet containing 360 picks. 72 each of .58, .71, .96, 1.14 and 36 each of 1.5 and 2.0.

- 417R** Specify Gauge, 72-Pack..**\$29.66**
- 417P** Specify Gauge, 12-Pack.....**5.82**

## DISPLAY



Put the latest Dunlop picks on your counter with the CP13 Counter Merchandiser. The CP13 features an assortment of the most popular Dunlop picks released over the last five years: Ultex Sharp Picks, Tortex TIII Picks, Nylon Max Grip Picks, Tortex Pitch Black Picks, and a selection of Jazz style picks.

- CP13** Counter Display -  
1080/pick.....**\$502.82**

### 1 pack, 72 of each

- Max Grip Std. -  
.60, .73, .88, 1.0, 1.14, 1.5
- Tortex TIII Std. -  
.50, .60, .73, .88, 1.0, 1.14
- Pitch Black Tortex Std. -  
.50, .60, .73, .88, 1.0, 1.14
- Ultex Sharp -  
.73, .90, 1.0, 1.14, 1.40, 2.0

### 3 packs of 24 each

- Max Grip Jazz - (Black) 3S, (Red) 3S, (Gray) 3C
- Ultex Jazz III - 427R 2.0
- Nylon Jazz III XL - (Black) 47RXLs, (Red) 47RXLN

## DISPLAY



## HANGMAN

The Hangman 2000 wall rack displays our Player's Packs packaging, to turn any prominent wall space into a focused and effective revenue generator. Each of two dozen rack hooks can hold 12 bags, for a total of 288 units per display. Re-ordering is a breeze as you easily track the hottest sellers.

- HM2000** .....**\$1,515.19**
- HM2000D** Display only .....**280.88**

## KIRK HAMMET

- KHO1T088** .....**\$7.65/6**

## JOHN PETRUCCI JAZZ III

Designed to the prog rock legend's own specifications, the John Petrucci Jazz III is made from Ultex and features a raised grip and a slick polished tip.

- 427BJP** Bag/36 .....**\$29.95**
- 427PIJP** Bag/6.....**5.63**

## JOHNNY CASH TINS

- JCPT01M** Memphis Med .....**\$7.65/6**
- JCPT02H** Legend Heavy.....**7.65/6**

## MATCH PIK



Match books containing 6 countoured nylon picks. Attractive P.O.P. counter display contains 12 books per popular gauge. 46mm, .60mm, .73mm, .88mm, .1.0mm

- 4480** Display .....**\$176.69**
- 448R** Refill, 12 Books of 6 Picks  
(Specify Gauge) .....**\$34.15**

Prices Subject to Change Without Notice

[www.jimdunlop.com](http://www.jimdunlop.com)

## PEAVEY® GUITAR PICKS



00479770

## JACK DANIEL'S® GUITAR PICKS



03004670

### GUITAR PICKS

<b>00479770</b>	Master Pick Rack .....	<b>\$439.99B</b>
Four level rack with 144 clam shells. Master Rack includes: Dreamers™, Abalone, Holographic, an StarTex™. Comes with Peavy Pick Center sign. Can be hung from slat wall or peg board. Refills available.		
<b>00479710</b>	TH Black StarTex™ 351 Clam Refill (Pkg. 12) .....	<b>\$3.99B</b>
<b>00479720</b>	TM Black StarTex™ 351 Clam Refill (Pkg. 12) .....	<b>3.99B</b>
<b>00479730</b>	MD Black StarTex™ 351 Clam Refill (Pkg. 12) .....	<b>3.99B</b>
<b>00479740</b>	MH Black StarTex™ 351 Clam Refill (Pkg. 12) .....	<b>4.19B</b>
<b>00479750</b>	HV Black StarTex™ 351 Clam Refill (Pkg. 12) .....	<b>4.19B</b>
<b>00479760</b>	XH Black StarTex™ 351 Clam Refill (Pkg. 12) .....	<b>4.19B</b>
<b>00479580</b>	HV Holographic 351 Clam Refill (Pkg. 12) .....	<b>4.99B</b>
<b>00479470</b>	TH Dreamers™ Red 351 Clam Refill (Pkg. 12) .....	<b>2.79B</b>
<b>00479480</b>	TM Dreamers™ Orange 351 Clam Refill (Pkg. 12) .....	<b>2.79B</b>
<b>00479490</b>	MD Dreamers™ Yellow 351 Clam Refill (Pkg. 12) .....	<b>2.79B</b>
<b>00479500</b>	MH Dreamers™ Green 351 Clam Refill (Pkg. 12) .....	<b>2.99B</b>
<b>00479510</b>	HV Dreamers™ Blue 351 Clam Refill (Pkg. 12) .....	<b>2.99B</b>
<b>00479520</b>	XH Dreamers™ Purple 351 Clam Refill (Pkg. 12) .....	<b>2.99B</b>

### PEAVY PICK HOLDER

<b>00444110</b>	.....	<b>\$7.19B</b>
Rubber pick holder with six holographic picks.		

<b>00579610</b>	Jack Daniel's Pick Kit .....	<b>\$99.99B</b>
270 picks in an 18 compartment box, 15 each per compartment of thin, medium, heavy. Old No. 7 on 9 bags and Jack Daniel's on 9 bags. Black Pearl, White Pearl, Black Matte.		
<b>00579620</b>	Jack Daniel's 72 piece Refill .....	<b>\$25.59B</b>
<b>00579580</b>	Jack Daniel's 351 Thin White Pearl Picks (Pkg. 12) .....	<b>9.99B</b>
<b>00579590</b>	Jack Daniel's 351 Medium White Pearl Picks (Pkg. 12) .....	<b>9.99B</b>
<b>00579600</b>	Jack Daniel's 351 Heavy White Pearl Picks (Pkg. 12) .....	<b>9.99B</b>
<b>00580140</b>	Jack Daniel's 351 Thin Black Pearl Picks (Pkg. 12) .....	<b>9.99B</b>
<b>00580150</b>	Jack Daniel's 351 Medium Black Pearl Picks (Pkg. 12) .....	<b>9.99B</b>
<b>00580160</b>	Jack Daniel's 351 Heavy Black Pearl Picks (Pkg. 12) .....	<b>9.99B</b>
<b>00580470</b>	Jack Daniel's 351 Thin Black Matte Picks (Pkg. 12) .....	<b>9.99B</b>
<b>00580480</b>	Jack Daniel's 351 Medium Black Matte Picks (Pkg. 12) .....	<b>9.99B</b>
<b>00580490</b>	Jack Daniel's 351 Heavy Black Matte Picks (Pkg. 12) .....	<b>9.99B</b>
<b>03004670</b>	Jack Daniel's Accessory Wall Display*	

\*Available with qualifying order – contact your sales rep for details

## MARVEL UNIVERSE PICK CLASSIC



<b>03011370</b>	Classic Pack 351 Medium (Pkg. 12) .....	<b>\$9.99B</b>
<b>03011380</b>	Villains Pack 351 Medium (Pkg. 12) .....	<b>9.99B</b>
<b>03011390</b>	Heroes 1 Pack 351 Medium (Pkg. 12) .....	<b>9.99B</b>
<b>03011400</b>	Heroes 2 Pack 351 Medium (Pkg. 12) .....	<b>9.99B</b>

## BRAIN PICKS

### BRAIN PICKS

Gauges:

.53 (Green) .60 (Purple) .73 (Red)  
.88 (Black) .100 (Grey) 1.14 (Orange)

**SDB351** Picks Kit – 432 pc .....\$256.65

**RSDB351** 72 pc / Specify Gauge .....43.20

**TSDB351** 12 Picks – Specify Gauge .....7.70  
i.e. 53TSDB351 = .53 Green Picks

## ALASKA PIK



Over the finger, under the nail picks

<b>APS</b>	SML	.....	<b>\$1.98B ea.</b>
<b>APM</b>	MED	.....	<b>1.98B ea.</b>
<b>APL</b>	LGE	.....	<b>1.98B ea.</b>
<b>APXL</b>	XLGE	.....	<b>1.98B ea.</b>
<b>BAPL</b>	LGE, Brass	.....	<b>2.25B ea.</b>
<b>BAPXL</b>	XLGE, Brass	.....	<b>2.25B ea.</b>

## PEARSE PICKS



Vintage celluloid

**JPTP** Thumb.....\$11.90B/10

Stainless Steel

**JPPF** Finger.....25.50B/10

Fast Turtle

**FTPT** Thin.....\$18.00 ea.

**FTPM** Med.....18.00 ea.

**FTPXH** X-Hvy.....18.00 ea.

## GUITAR TATTOOS



Available in 12 exciting designs that are easy to apply, Guitar Tattoos are the easiest way to customize the look of your guitar.

**GT77010** Reporting for duty.....\$4.99

**GT77014** Devil Girl.....4.99

**GT77006** Ribbon Skull.....4.99

**GT77007** Grey Iron Cross.....4.99

**GT77011** Blue Flame Skull.....4.99

**GT77008** Dagger Rose Skull.....4.99

**GT77005** Grim Reaper.....4.99

**GT77017** Reaper 3 Skulls.....4.99

**GT77002** Peak A Boo Skull.....4.99

**GT77015** Ax Clown.....4.99

**GT77016** Freedom Eagle.....4.99

**GT77013** Flame Whip Skull.....4.99

## DAVA CONTROL PICKS



6024

6036

### GRIP TIPS

Grip the tip for a hard gauge or release the center section for a smooth rhythm feel. Grip Tips are available in delrin nylon and our polly gels.

**6108** Cabinet Delrin 144 picks, 6 colors.....\$180.00

**6228** Refill Bag Delrin 72 picks, 6 colors.....90.00

**6036** Refill Bag Delrin 36 picks, 6 colors.....45.00

**6024** Hang Bag Delrin 6 picks, 6 colors.....7.50

**6338** Refill Bag Nylon 72 picks, Lt. Green.....90.00

**6936** Refill Bag Nylon 36 picks, Lt. Green.....45.00

**6924** Hang Bag Nylon 6 picks, Lt. Green.....7.50

**6448** Refill Bag Gels 72 picks, Cherry.....90.00

**6636** Refill Bag Gels 36 picks, Cherry.....45.00

**6624** Hang Bag Gels 6 picks, Cherry.....7.50

### MASTER CONTROL SERIES

Dava's patented Master Control pick is the only pick to combine a metal edge with plastic flexibility. The nickel silver tip is the same material as guitar fret wire.

**0369** Master Control Refill Bag 24 picks.....\$70.80

**0109** Master Control Hang Bag 1 pick.....2.95

### JAZZ GRIPS

Smaller and a lot stiffer, Jazz Grips are made from delrin and at a size players are used to for a jazz pick, they combine a sharp tip with our over-molded rubber grip.

**9072** Refill Bag Delrin, 72 picks, Red.....\$90.00

**9036** Refill Bag Delrin 36 picks, Red.....45.00

**9024** Hang Bag Delrin 6 picks, Red.....7.50

**9172** Refill Bag Nylon 72 picks, Lt. Green.....90.00

**9136** Refill Bag Nylon 36 picks, Lt. Green.....45.00

**9124** Hang Bag Nylon 6 picks, Lt. Green.....7.50

**9272** Refill Bag Gels 72 picks, Orange.....90.00

**9236** Refill Bag Gels 36 picks, Orange.....45.00

**9224** Hang Bag Gels 6 picks, Orange.....7.50

### DAVA CONTROL

Introduced in 1996, our original patented multi-gauge Control Pick is the first design to give musicians the ability to control pick gauge while playing. Simply grip the tip for a hard gauge or release the flexible center section for a soft gauge.

**7008** Refill Bag Nylon 70 picks, Teal.....\$52.50

**D0508** Hang Bag Nylon 5 picks, Teal.....3.75

**8708** Refill Bag Gels 70 picks, Orange.....52.50

**8508** Hang Bag Gels 5 picks, Orange.....3.75

**8558** Gels 100 pack, asst. colors.....75.00

### ROCK CONTROL SERIES

Combine our multi-gauge grip with our delrin tip and you get a rhythm and lead pick in one, with a tip that gives a fast release and a very smooth feel.

**1336** Delrin Refill Bag 36 picks .....\$45.00

**1303** Delrin Hang Bag 6 picks.....7.50

## DAVA ASSORTMENTS



8128

### DAVA SAMPLE 66 ASSORTED PICKS

12 each Grip Tips, Jazz Grips Dava Control, Control Gels and Rock Control Delrin & 6 Master Control.

**8128** .....\$80.70

24 each Grip Tips & Jazz Grips in Delrin, Nylon & Gels.

**9000** .....\$180.00

## FRED KELLY THUMB PICKS

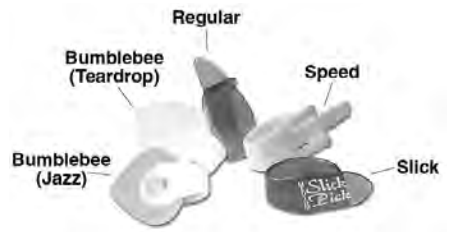

### SPEED PICKS (24/Pack)

Allows more true tone clarity

**SP1L** Yellow, Light.....\$34.05

**SP1M** Orange, Medium.....34.05

**SP1H** White, Heavy.....34.05

### SLICK PICKS (24/Pack)

Thumb pick that acts like a straight pick

**SP2L** Yellow, Light.....\$34.05

**SP2M** Orange, Medium.....34.05

**SP2H** White, Heavy.....34.05

### POLY CARBONATE (24/Pack)

**SP3M** Medium.....\$34.05

**SP3H** Heavy.....34.05

**SP3XH** Extra Heavy.....34.05

**FKRGP** Regular.....34.05

### DELRIN (24/Pack) STANDARD 351

**FKDT** Thin.....\$10.80

**FKDM** Medium.....10.80

**FKDH** Heavy.....10.80

**FKRGD** Regular.....34.05

### NYLON (24/Pack) STANDARD 351

**FKNT** Thin.....\$10.80

**FKNM** Medium.....10.80

**FKNH** Heavy.....10.80

### BUMBLE BEE (3/Pack)

**BBL** Lite, Jazz Shape.....\$13.50

**BBM** Med., Jazz Shape.....13.50

**BBH** Hvy., Jazz Shape.....13.50

**BBDTH** Hvy, Tear Drop.....13.50

### FREEDOM (3/Pack) FINGER PICK

#### POLY CARBONATE

**P7FFL** Large.....\$15.65B

**P7FFM** Medium.....15.65B

**P7FFS** Small.....15.65B

#### DELRIN

**D7FFL** Large.....\$15.65B

**D7FFM** Medium.....15.65B

**D7FFS** Small.....15.65B

## POCKET PICKS



The Pocket Pik is great to carry in the wallet ensuring you are always ready for the impromptu jazz session.

**PPS101** Guitars.....\$187.50 box

**PPS102** Skull.....187.50 box

**PPS103** Psychodelic.....187.50 box

**PPS104** Guitar Neck.....187.50 box

**PPS105** U.S. Flag.....187.50 box

Each box 125 cards, 4 picks each

**PPS201** Guitars.....\$129.35 box

**PPS202** Skull.....129.35 box

**PPS203** Psychodelic.....129.35 box

**PPS204** Guitar Neck.....129.35 box

**PPS205** U.S. Flag.....129.35 box

Each box 65 cards, 6 picks each

# CLAYTON PICKS



## ULTEM

Display cabinet contains 2 gross (288 picks) of 18 models assorted (3 styles, 6 gauges). Styles are: Rounded Triangle, Standard, and Small Teardrop. Gauges: .38mm, .45mm, .56mm, .72mm, .80mm, & .94mm.

**CUTD** .....\$198.75

### ROUNDED TRIANGLE

**CURT56** .56mm .....\$33.15  
**CURT72** .72mm .....33.15  
**CURT80** .80mm .....33.15  
**CURT94** .94mm .....33.15  
**CURT107\*** 1.07mm .....37.95  
**CURT120\*** 1.20mm .....41.30  
**12CURT** Refill .....8.30/12



### PLAYBOY

351 Shape, 12 per pack  
**12CPBS** Black, T, M, H .....\$6.00  
**12CPPS** Pink, T, M, H .....6.00  
**12CPWSM** Wings, Med. ....6.00B  
**12CPHSM** Hottie, Med. ....6.00B



### SKULL

351 Shape, 12 per pack  
**12CDRT** Thin .....\$7.00  
**12CDYM** Medium .....7.00  
**12CDBH** Heavy .....7.00



### LIQUID SUN

351 Shape, 12 per pack  
**12CLS** T, M, H .....\$6.99



### CAMO

351 Shape, 12 per pack  
**12CCFM** Medium .....\$6.99

### STANDARD

**CUS38** .38mm .....\$33.15  
**CUS45** .45mm .....33.15  
**CUS56** .56mm .....33.15  
**CUS72** .72mm .....33.15  
**CUS80** .80mm .....33.15  
**CUS94** .94mm .....33.15  
**CUS107\*** 1.07mm .....37.95  
**CUS120\*** 1.20mm .....41.30  
**12CUS** Refill .....8.30/12

### SMALL TEARDROP

**CUST38** .38mm .....\$33.15  
**CUST45** .45mm .....33.15  
**CUST56** .56mm .....33.15  
**CUST80** .80mm .....33.15  
**CUST94** .94mm .....33.15  
**CUST107\*** 1.07mm .....37.75  
**CUST120** 1.20mm .....41.30  
**Refills, 48 pc. per bag**  
**12CUST** Refill .....\$8.30/12



### HULA HOTTIE

351 Shape, 12 per pack  
**12CHH** T, M, H .....\$7.00



### CRAZED CLOWN

351 Shape, 12 per pack  
**12CCC** T, M, H .....\$7.20

[www.steveclayton.com](http://www.steveclayton.com)

**FAX & E-MAIL ORDERS FOR PRINTED  
 MUSIC WILL GET AN EXTRA  
 5% DISCOUNT**

**FAX:  
 (708) 496-2130  
 (888) 983-5537**

**E-MAIL:  
[sales@harristeller.com](mailto:sales@harristeller.com)**



## ACETAL

### ACETAL/POLYMER (DISPLAY)

Contains 3 gross of 18 models evenly assorted.

**CAPD** .....\$211.70

### ROUNDED TRIANGLE

**CRT38** .38mm Purple  
**CRT50** .50mm Blue  
**CRT63** .63mm Green  
**CRT80** .80mm Yellow  
**CRT100** 1.00mm Brown  
**CRT126** 1.26mm Silver  
**CRT152** 1.52mm Silver  
**CRT190** 1.90mm Silver  
**12CRT** Refill .....\$5.90/12

### STANDARD

**CS38** .38mm Purple  
**CS50** .50mm Blue  
**CS63** .63mm Green  
**CS80** .80mm Yellow  
**CS100** 1.00mm Brown  
**CS152** 1.52mm Silver  
**CS190** 1.90mm Silver  
**12CS** Refill .....\$5.90/12



### SAND SHARK

351 Shape, 6 per pack  
 .38 .50, .63 .80 1.00-1.26 gauge  
**6CSH** Specify gauge .....\$5.35



### SPIKE ULTEM GOLD

351 Shape, 12 per pack  
 .56 .72 .80 gauge  
**12CUSSS** Specify gauge .....\$8.30

**SMALL TEARDROP** .....\$35.30/72  
**CST63** .63mm Green  
**CST80** .80mm Yellow  
**CST100** 1.00mm Brown  
**CST126** 1.26mm Silver  
**CST152** 1.52mm Silver

**CRT, CS, CST152, 190** .....\$46.10  
**12CST** Refill .....\$5.90/12



### PICK OF DESTINY

**CTDM6** Pick .....\$ 7.00/6 pk.  
**CTDRPN** LED Necklace .....13.00  
**CTDGNP** Necklace .....8.00  
**CTDRP** Replica Pick .....9.00



**CHRISTIAN EDITION:** Jesus, Madonna, Crosses, Praying hands, etc. Starter Display contains, 288 pcs.

**CCSD** .....\$172.80  
 Refills: 48 pcs. ....28.80  
**CCS38** .38mm  
**CCS50** .50mm  
**CCS63** .63mm  
**CCS100** 1.00mm  
**12CCS** Specify gauge, 12 pack .....7.20



### FIRE BREATHERS

351 Shape, 12 per pack  
**12CFB** T, M, H .....\$6.99



### CORK GRIP

351 Shape, 6 per pack  
 .38 .50, .63 .80 1.00-1.26 gauge  
**6CCG** Specify gauge .....\$4.20

# PLANET WAVES PICKS

## KISS COLLECTION

KISS is arguably the most iconic band in history. Planet Waves honors KISS with a unique collection of guitar picks featuring album cover artwork and images of Demon, Starchild, Catman and Spaceman.



	Thin	Medium	Heavy
Kiss	ICBK210K1	1CBK410K1	ICBK610K1
Rock and Roll Over	ICBK210K2	1CBK410K2	ICBK610K2
Alive II	ICBK210K3	1CBK410K3	ICBK610K3

10 pack – **\$10.20**

## JOE SATRIANI COLLECTIBLE GUITAR PICKS

The 10 sketches on these picks were reproduced directly from Joe Satriani's personal sketch books. JS picks are made of premium celluloid and are available in white with black printing or black with silver printing. Each 10-pack includes 1 each of 10 different pieces of JS art.

<b>1CBK210JS</b>	10-Pack JS Picks, Black, Thin...	<b>\$10.20</b>
<b>1CBK410JS</b>	10-Pack JS Picks, Black, Med...	<b>10.20</b>
<b>1CBK610JS</b>	10-Pack JS Picks, Black, Heavy..	<b>10.20</b>
<b>1CWH210JS</b>	10-Pack JS Picks, White, Thin....	<b>10.20</b>
<b>1CWH410JS</b>	10-Pack JS Picks, White, Med....	<b>10.20</b>
<b>1CWH610JS</b>	10-Pack JS Picks, White, Heavy.	<b>10.20</b>
<b>JSCD01</b>	4-Pack JS Picks, Chrome Dome .....	<b>10.20</b>



## BEATLES SIGNATURE PICK COLLECTION

From *Love Me Do* to *Revolution*, the Beatles were arguably the most creative, diverse and influential band in pop music history. Planet Waves honors The Beatles' legacy with a unique collection of guitar picks, featuring iconic album covers and timeless images which capture the enduring spirit and essence of the "Fab Four."



<b>1CWH210B1</b>	Revolver, Thin, 10 pk.....	<b>\$10.20</b>
<b>1CWH410B1</b>	Revolver, Medium, 10 pk.....	<b>10.20</b>
<b>1CWH610B1</b>	Revolver, Heavy, 10 pk.....	<b>10.20</b>
<b>1CBK210B2</b>	Meet the Beatles, Thin, 10 pk.	<b>10.20</b>
<b>1CBK410B2</b>	Meet the Beatles, Med., 10 pk	<b>10.20</b>
<b>1CBK610B2</b>	Meet the Beatles, Hvy, 10 pk..	<b>10.20</b>
<b>1CWH210B3</b>	Albums, Thin, 10 pk.....	<b>10.20</b>
<b>1CWH410B3</b>	Albums, Medium, 10 pk.....	<b>10.20</b>
<b>1CWH610B3</b>	Albums, Heavy, 10 pk.....	<b>10.20</b>

## BEATLES PICK TINS



<b>1CAB415BT1</b>	Beatles Pick Tin, Logo, 15 picks.....	<b>\$13.25</b>
<b>1CAB415BT2</b>	Beatles Pick Tin, Stripes, 15 picks.....	<b>13.25</b>
<b>1CAB415BT3</b>	Beatles Pick Tin, Sgt. Peppers, 15 picks.....	<b>13.25</b>

[www.planetwaves.com](http://www.planetwaves.com)



## DURALIN GUITAR PICKS

Duralin (also known as Acetyl) is a unique material with an extraordinary combination of strength, stiffness, dimensional stability, toughness, fatigue resistance, abrasion resistance and low friction. Standard shape, packs of 100.....

<b>1DRD1100</b>	Super Light gauge .019" (.50mm)	<b>\$35.70</b>
<b>1DOR2100</b>	Light gauge .024" (.60mm)	
<b>1DYL3100</b>	Light medium gauge .028" (.70mm)	
<b>1DGN4100</b>	Medium gauge .033" (.85mm)	
<b>1DBU5100</b>	Medium heavy gauge .039" (1.0mm)	
<b>1DPR6100</b>	Heavy gauge .047" (1.2mm)	
<b>1DBK7100</b>	Extra heavy gauge .059" (1.5mm)	
<b>1DOR225</b>	.024 – Packs of 25.....	<b>\$10.20</b>
<b>1DBU525</b>	.039 – Packs of 25.....	<b>10.20</b>
<b>1DPR625</b>	.047 – Packs of 25.....	<b>10.20</b>

## THE NYLPRO PLUS JAZZ GUITAR PICK

Formulated with a combination of injection molded nylon and glass fiber, the result is a harder pick with a brighter tone. The Nylpro Plus features the same Nylpro design utilizing a double textured mold for smooth playing and maximum grip.

<b>3NPP710</b>	10 Pack.....	<b>\$ 4.60</b>
<b>3NPP725</b>	25 Pack.....	<b>10.20</b>
<b>3NPP7100</b>	100 Pack.....	<b>35.70</b>

Available in Extra Heavy: 1.4mm



## BLACK ICE PICKS

Black Ice Picks feature a custom jazz shape that is perfect for fast picking and playing where precise articulation is required.

<b>3DBK210</b>	Jazz Shape, Light gauge (.55mm), 10 pack.....	<b>\$5.60</b>
<b>3DBK410</b>	Jazz Shape, Medium gauge (.80mm), 10 pack.....	<b>5.60</b>
<b>3DBK610</b>	Jazz Shape, Heavy gauge (1.10mm), 10 pack.....	<b>5.60</b>
<b>3DBK710</b>	Jazz Shape, Extra Heavy gauge (1.5mm), 10 pack.....	<b>5.60</b>

# CELLU-GLO CELLULOID PICKS

## Cortex Picks

Cortex picks are precision molded to eliminate grain structures, allowing for dynamic pick response. This unique material closely resembles actual tortoise shell in feel and sound yet offers high strength, durability and heat resistance. Cortex long lasting picks offer excellent attack with a clean, crisp tone for superior note definition, allowing notes to leap from your strings. Attack, control, clarity and durability...Cortex Picks!

<b>1UCT210</b>	Light Gauge .55mm, 10 pk.....	<b>\$ 7.65</b>
<b>1UCT225</b>	Light Gauge .55mm, 25 pk.....	<b>19.40</b>
<b>1UCT2100</b>	Light Gauge .55mm, 100 pk .....	<b>76.50</b>
<b>1UCT410</b>	Med Gauge .80 mm, 10 pk.....	<b>7.65</b>
<b>1UCT425</b>	Med Gauge .80 mm, 25 pk .....	<b>19.40</b>
<b>1UCT4100</b>	Med Gauge .80 mm, 100 pk .....	<b>76.50</b>
<b>1UCT610</b>	Heavy Gauge 1.10 mm, 10 pk.....	<b>7.65</b>
<b>1UCT625</b>	Heavy Gauge 1.10 mm, 25 pk .....	<b>19.40</b>
<b>1UCT6100</b>	Heavy Gauge 1.10 mm, 100 pk .....	<b>76.50</b>
<b>1UCT710</b>	Ex Hvy Gauge 1.5 mm, 10 pk.....	<b>7.65</b>
<b>1UCT725</b>	Ex Hvy Gauge 1.5 mm, 25 pk .....	<b>19.40</b>
<b>1UCT7100</b>	Ex Hvy Gauge 1.5 mm, 100 pk.....	<b>76.50</b>

## Cellu-Glo Celluloid Picks

Planet Waves puts a new twist on celluloid picks. Now you can still have the natural feel and warm fat tone of celluloid in a "glow in the dark" pick. Simply pre-charge the picks in natural sunlight or under a light bulb and you have a pick that not only sounds great but looks great too. The Cellu-Glo picks add a new visual element to your playing and are also easy to find on dark stages. Available in four thicknesses.

<b>1CCG210</b>	Light Gauge .55 mm, 10 pk.....	<b>\$ 4.60</b>
<b>1CCG225</b>	Light Gauge .55 mm, 25 pk.....	<b>10.20</b>
<b>1CCG2100</b>	Light Gauge .55 mm, 100 pk.....	<b>35.70</b>
<b>1CCG410</b>	Med Gauge .80 mm, 10 pk .....	<b>4.60</b>
<b>1CCG425</b>	Med Gauge .80 mm, 25 pk .....	<b>10.20</b>
<b>1CCG4100</b>	Med Gauge .80 mm, 100 pk.....	<b>35.70</b>
<b>1CCG610</b>	Hvy Gauge 1.10 mm, 10 pk.....	<b>4.60</b>
<b>1CCG625</b>	Hvy Gauge 1.10 mm, 25 pk.....	<b>10.20</b>
<b>1CCG6100</b>	Hvy Gauge 1.10 mm, 100 pk.....	<b>35.70</b>
<b>1CCG710</b>	Ex Hvy Gauge 1.5 mm, 10 pk .....	<b>4.60</b>
<b>1CCG725</b>	Ex Hvy Gauge 1.5 mm, 25 pk.....	<b>10.20</b>
<b>1CCG7100</b>	Ex Hvy Gauge 1.5 mm, 100 pk.....	<b>35.70</b>

## Camouflage Celluloid



### Standard Shape

<b>1CCF210</b>	Light Gauge .50 mm, 10 pk.....	<b>\$ 4.60</b>
<b>1CCF225</b>	Light Gauge .50 mm, 25 pk.....	<b>10.20</b>
<b>1CCF2100</b>	Light Gauge .50 mm, 100 pk.....	<b>35.70</b>
<b>1CCF410</b>	Med Gauge .70 mm, 10 pk .....	<b>4.60</b>
<b>1CCF425</b>	Med Gauge .70 mm, 25 pk .....	<b>10.20</b>
<b>1CCF4100</b>	Med Gauge .70 mm, 100 pk .....	<b>35.70</b>
<b>1CCF610</b>	Hvy Gauge 1.00 mm, 10 pk.....	<b>4.60</b>
<b>1CCF625</b>	Hvy Gauge 1.00 mm, 25 pk.....	<b>10.20</b>
<b>1CCF6100</b>	Hvy Gauge 1.00 mm, 100 pk .....	<b>35.70</b>
<b>1CCF710</b>	Ex Hvy Gauge 1.25 mm, 10 pk .....	<b>4.60</b>
<b>1CCF725</b>	Ex Hvy Gauge 1.25 mm, 25 pk.....	<b>10.20</b>
<b>1CCF7100</b>	Ex Hvy Gauge 1.25 mm, 100 pk.....	<b>35.70</b>

## SPERZEL MACHINES



**TRIM LOK 6 IN LINE**

6LTLC	Chrome	\$109.50
6LTLC	Satin Chrome	99.00
6LTB	Black	104.25
6LTG	Satin Gold	125.25
6LTGP	Gold Plated	150.00
LH6LTLC	Chrome, Lefty	108.00
LH6LTB	Black, Lefty	104.25
LH6LTGP	Gold, Lefty	150.00



**TRIM LOK 3+3**

33TLCP	Chrome	\$109.50
33TLSC	Satin Chrome	99.00
33TLSCI	Satin Chrome	99.00
33TLBK	Black	104.25
33TLGO	Satin Gold	125.25
33TLGP	Gold Plated	150.00
33TLGOI	Satin Gold	125.25



**STANDARD 6 IN LINE (NON LOCKING)**

6LSTDSC	Satin Chrome	\$78.00
6LSTDGO	Satin Gold	97.50
6LSTDBK	Satin Black	87.00



**STANDARD 3+3 (NON LOCKING)**

33STDSC	Satin Chrome	\$78.00
33STDBK	Black	87.00
33STDBK1	Black	87.00

**TRIM LOK 3+3 (E-Z MOUNT)**

33TLEZBK	Black 3+3	\$104.25
33TLEZCP	Chrome 3+3	109.50
33TLEZGO	Gold 3+3	125.25
33TLEZSC	Satin Chrome 3+3	99.00

**TRIM LOK 6 IN LINE**

6LTEZBK	Black	\$104.25
6LTEZCP	Chrome	109.50
6LTEZGO	Gold	125.25
6LTEZSC	Satin Chrome	99.00



**BASS 4 IN LINE**

4LTLC	Satin Chrome	\$108.00
4LTB	Black	117.00
4LTG	Gold	128.25
4LTLC	Chrome	127.50

**BASS 2+2**

22TLGO	Gold	\$128.25
--------	------	----------

## TONE PROS KLUSON MACHINES



**3+3**

TPK33N	Keystone Button Nickel	\$67.50B
TPK33C	Keystone Button Chrome	67.50B
TPK33GO	Keystone Button Gold	89.50B
TPK33SN	Keystone Button Satin Nickel	89.50B
TPKG2N	Double Ring Keystone Button, press bushing, Nickel	72.50B
TPKG2G	Double Ring Keystone Button, press bushing, Gold	94.50B



**3+3**

TPKR3N	On Rail Rnd White Button Nickel	\$67.50B
TPKBWN	Rnd White Button Nickel	67.50B
TPKBWC	Rnd White Button Chrome	67.50B
TPKBWGO	Rnd White Button Gold	89.50B



**3+3**

TPKB3N	Keystone Bolt Bushing Nickel	\$67.50B
TPKB3C	Keystone Bolt Bushing Chrome	67.50B
TPKB3GO	Keystone Bolt Bushing Gold	89.50B
TPKB3SN	Keystone Bolt Bushing Satin Nickel	89.50B
TPKB3BK	Keystone Bolt Bushing Black	89.50B



**6 IN LINE (BOLT BUSHING)**

TPKF6BN	Nickel	\$67.50B
TPKF6BC	Chrome	67.50B
TPKF6BLN	Locking Nickel	92.50B
TPKF6BLC	Locking Chrome	92.50B
TPKF6BLGO	Locking Gold	99.50B
TPKF6BLSN	Locking Satin Nickel	99.50B
TPKF6BLBK	Locking Black	99.50B



**6 IN LINE (LEFTY)**

TPKF6BNLH	Bolt Bushing Nickel	\$67.50B
TPKF6BCLH	Bolt Bushing Chrome	67.50B
TPKF6BGLH	Bolt Bushing Gold	89.50B
TPKF6BKLH	Bolt Bushing Black	89.50B



**3+3 (LOCKING)**

TPKB3LN	Keystone Bolt Bushing Nickel	\$92.50B
TPKB3LC	Keystone Bolt Bushing Chrome	92.50B
TPKB3LGO	Keystone Bolt Bushing Gold	99.50B
TPKB3LBK	Keystone Bolt Bushing Black	99.50B

## GROVER MACHINES

### VINTAGE



135N	Nickel, 3+3, Plastic Button	\$63.85
135G	Gold, 3+3, Plastic Button	95.85
136N6	6 in Line, Nickel/Metal	63.85
136N	3+3, Nickel, Metal Button	63.85
136G6	6 in Line Gold, Metal Button	95.85
136G	3+3, Gold, Metal Button	95.85
H138N	3 on Plate, Horizontal/Nickel	67.05
V138N	3 on Plate, Vertical/Nickel	67.05

### CLASSICAL

303N	Nickel plated	\$42.25
303G	Gold plated	63.45

**DELUXE PEARLOID BUTTONS**

306N	Nickel	\$58.95
306G	Gold	84.15

## GOLDEN GATE MACHINES



**OFFSET SCREW HOLE**

SF2070	3+3 Nickel	\$38.80
SF2075	3+3 Chrome	28.30
SF2080	3+3 Chrome, Mini Buton	30.40

### STA TITE



V98N	Nickel, 3+3	\$33.75
V98C	Chrome, 3+3	34.65

**VINTAGE**

V97C	Vertical, Chrome, 3+3	\$52.15
V97N	Vertical, Nickel, 3+3	49.05
V9718NA	Vertical, Nickel, 3+3, 18-1	59.40
V9718GA	Vertical, Gold, 3+3, 18-1	105.75
H97N	Horizontal, Nickel, 3+3	49.00

**18:1 GEAR RATIO**

H9718GA	Gold	\$105.75
---------	------	----------



# GROVER MACHINES

## LOCKING



<b>3 + 3 MINI</b>		
406C	Chrome .....	\$81.00
406G	Gold .....	120.15



<b>3&amp;318:1</b>		
106C	Chrome .....	\$99.85
106G	Gold .....	120.15
106BC	Black Chrome .....	120.15

<b>6-IN-LINE, MINI</b>		
406C6	Chrome .....	\$81.00
406G6	Gold .....	120.15
406CL6	Chrome, Lefty .....	89.55
406BC6	Black Chrome .....	120.15

<b>TIP LOCK (602 SERIES) 3 + 3</b>		
602C	Chrome .....	\$80.55
602BC	Black Chrome .....	103.05
602G	Gold .....	108.00

## MINI



205C6	Chrome, 6 in line .....	\$68.85
205G6	Gold, 6 in line .....	102.15



205C	Chrome, 3 + 3 .....	\$68.85
205G	Gold, 3 + 3 .....	102.15
205BC	Black, 3 + 3 .....	102.15
205BN	Black, Nickel 3 + 3 .....	102.15
205BC6	6 in Line, Black .....	102.15
205BN6	6 in Line, Black, Nickel .....	102.15
205BCL6	6 in Line, Black, Left Handed .....	102.15
205CL6	6 in Line, Chrome, Lefty .....	68.85
2050E	Mini Ebony Button .....	6.75

## IMPERIAL



150C	Chrome, 3+3 .....	\$98.55
150G	Gold, 3+3 .....	144.45

## BASS



<b>TITAN</b>		
145C4	Chrome, 4 in line .....	\$98.55
145C	Chrome, 2+2 .....	98.55



<b>VINTAGE</b>		
142C4	Chrome, 4 in line .....	\$80.95
142C	Chrome, 2+2 .....	66.15

<b>LIGHTWEIGHT BASS (143 SERIES)</b>		
Gear Ratio 20:1		
143C	Chrome, 2+2 .....	\$135.00
143BC	Black Chrome, 2+2 .....	166.50
143G	Gold, 2+2 .....	189.00
143C4	Chrome, 4 in Line .....	135.00
143BC4	Black Chrome, 4 in Line .....	166.00
143G4	Gold, 4 in Line .....	189.00

Note: Also available 4 treble side, i.e., 143CL4

## MINI BASS



<b>2 TREBLE + 2 BASS</b>		
144C	Chrome .....	\$78.75
144G	Gold .....	120.15
144BC	Black Chrome .....	119.65



<b>4-IN-LINE</b>		
144C4	Chrome-plated .....	\$78.75
144G4	Gold-plated .....	120.15
144BC4	Black Chrome .....	119.65

## DELUXE



Used on Vintage & Reproduction Models of famous guitars.		
133N	Nickel, 3 & 3 .....	\$56.25
133N6	Nickel, 6 in Line .....	56.25

## ROTOMATIC



Gear ratio of 14-1.		
102N	Nickel .....	\$66.15
102C	Chrome .....	68.85
102G	Gold .....	102.15
102BC	Black .....	102.15
102BN	Black Nickel .....	102.15
102CS	Satin Chrome .....	102.15
102NK	Nickel, Keystone Button .....	66.15
102GK	Gold, Keystone Button .....	102.15
102GW	Gold w/White Pearloid Button .....	118.65

<b>102V Series (Milkbottle Style)</b>		
Gear Ratio 18:1, 3+3		
102CV	Chrome .....	\$68.85
102NV	Nickel .....	66.15
102GV	Gold .....	102.15

<b>Original Rotomatic w/Pearloid Button (103 Series)</b>		
103C	Chrome .....	\$89.25
103G	Gold .....	121.50



18:1 Gear Ratio		
10218N	18:1 Nickel .....	\$89.95
10218C	18:1 Chrome .....	76.05
10218G	18:1 Gold .....	114.30
10218BC	18:1 Black Chrome .....	114.30
1020E	Ebony Button/Brass Insert .....	6.75
1090P	3 Step Pearl Button Imitation .....	6.00
GX1360D	Full Imitation Pearl Button .....	6.75

## SUPER ROTOMATIC



109C	Chrome, Rotomatic .....	\$78.75
109G	Gold, Rotomatic .....	114.75

## ROTO GRIP LOCKING



<b>3 + 3</b>		
502C	Chrome .....	\$104.00
502G	Gold .....	146.95
502BC	Black Chrome .....	146.99
502CK	Chrome Keystone Button .....	104.00



<b>3 + 3 MINI</b>		
505C	18:1 Chrome .....	\$103.99
505G	18:1 Gold .....	146.95
505BC	18:1 Black Chrome .....	146.90

<b>6 IN LINE MINI</b>		
505C6	18:1 Chrome .....	\$104.00
505CL6	18:1 Chrome, Lefty .....	104.00
505G6	18:1 Gold .....	146.90
505GL6	18:1 Gold, Lefty .....	139.05
505BC6	18:1 Black .....	139.05
505BCL6	18:1 Black, Lefty .....	139.05

# PING MACHINES



## CLASSICAL

- P2620** Nickel, Plastic Buttons .....\$18.71
- P2621** Nickel, Lyre Plate .....21.83
- P2622** Nickel, Butterfly Buttons .....24.99
- P2623** Gold, Butterfly Buttons .....36.99
- P2624** Black .....35.99
- P2625** Deluxe Gold .....79.99
- P2627** Individuals, Plastic Buttons .....21.99
- P2626** Nickel, Lyre Plate, Pearloid.....29.99



- P2640** 3 + 3, Plastic Buttons .....\$20.99
- P2641** 3 + 3, Chrome Buttons .....27.49
- P26416L** 6 in line, Chrome Buttons .....30.49



- P2650** 3 + 3, Chrome .....\$56.99
- P2651** 3 + 3, Gold .....76.99
- P2654** 3 + 3, Chrome .....59.99
- P2655** 3 + 3, Gold .....85.99



## SMALL COVERED BASS

- P2680** 2 Treble/2 Bass, Chrome .....\$51.99
- P2681** 4 in line, Chrome .....52.99



- P2750** 3 + 3, Chrome, Prl Button .....\$88.49
- P2751** 3 + 3, Gold, Amber Button .....98.99



- P2642** 3 + 3, Chrome .....\$32.49
- 6LP2642** 6 in line, Chrome, Right Gtr.....32.90
- 6RP2642** 6 in line, Chrome, Lefty Gtr .....32.90
- P2643** 3 + 3, Gold .....57.99
- P2645** 6 in line, Kluson Style .....56.99
- P2644** 3 + 3, Kluson Style.....56.99



- P2652** Mini, 6 in line, Chrome .....\$57.99
- P2653** Mini, 6 in line, Gold .....79.99
- P2659** Mini, 6 in line, Black.....73.99
- P2659R** Mini, 6 in line, Black, Lefty.....73.99



## POPULAR OPEN STYLE

- P2682** 4 in line, Chrome .....\$76.99



- P2630** 3 + 3 Plastic Buttons .....\$17.99
- P2631** 3 + 3 Plastic/Chrome Buttons .....20.99
- P2632** 3 + 3 Chrome Buttons .....27.99
- P2633** 3 + 3 Chrome, Lyre Plate.....30.99



- P2634** 6 in line, Chrome .....\$29.99
- P2670** 12 String, Plastic Buttons .....31.99
- P2671** 12 String, Chrome Buttons .....43.99



- P2656** Mini, 6 in line, Chrome.....\$55.99
- P2657** Mini, 6 in line, Gold .....79.99



## SEALED GEAR STYLE

- P2685** Chrome 4 in line .....\$80.99
- P2686** Black 4 in line .....99.99
- P2687** Gold 4 in line.....102.99

# WD MACHINES

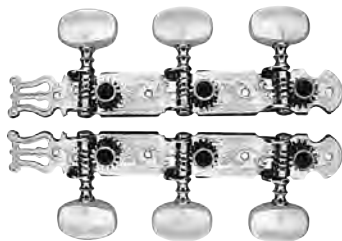

Classic. Nickel plate with plain buttons.

- WD1276** .....\$24.99
- WD1292** Gold.....38.95

Classic. Nickel plate with butterfly buttons.

- WD1256** .....24.99
- WD1258** Gold.....33.50

3 On Plate. Inlaid nickel plate with plastic buttons.

- WD1251** .....24.95

6 Inline. Inlaid plate with open gears and metal buttons.

- WD1269** .....\$31.95
- WD1268** Plastic Buttons .....31.95

Individual. Chrome plated with covered gear housing and metal buttons. 3 + 3

- WD1263CR**.....24.95

Individual. Nickel plated with metal buttons.

- WD1266** .....24.95

Individual. Nickel plated with plastic buttons.

- WD1253** .....12.95

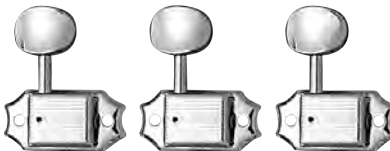

## KLUSON

- SD9005MG** 3/side Gold .....\$75.00
- SD9005MN** 3/side Nickel .....60.00
- SD90SLG** 3/side Gold/Pearl .....80.00
- SD90SLN** 3/side Nickel/Pearl .....60.00
- SD9105MBK** 6 In Line Black .....65.00
- SD9105MGO** 6 In Line Gold .....75.00
- SD9105MN** 6 In Line Nickel.....60.00
- SD9105MNR** 6 In Line Nickel LH .....50.00
- WD90NPM** 3 on a Plate Nickel/Metal .....60.00
- WD90NPP** 3 on a Plate Nickel/Plastic .....60.00
- SD9105MNP** 6 Inline Nickel/Plastic.....60.00
- SD91MLNL** 6 On a Plate Nickel .....65.00
- SD91PLNL** 6 On a Plate Nickel/Plastic.....60.00
- MB65NL** Adaptor Bushing .....12.00/6

## LOCKING

- WDMLBK** 6 in line, locking, black .....\$60.00
- WDMLC** 6 in line, locking, chrome .....50.00

## 6 IN LINE, LEFTY MACHINES

- SG3805BR** Black.....\$56.00
- SG3805CR** Chrome .....43.20

# GOTOH MACHINES



GT050



- GT030C** Chro 3 + 3..... \$93.40
- GT036B** Blk 3 + 3 .....96.85
- GT036C** Chro 3 + 3 .....85.65
- GT360C** Chro 6 In Line .....85.65
- GT050C** Chro 3 + 3 .....76.30
- GT090G** Gold 3 + 3 Kluson Type .....126.30
- GT090N** Nickel 3 + 3 Kluson Type.....83.15

## PLANET WAVES MACHINES



### AUTO-TRIM, BUILT IN STING CUTTER

PWAT6R1	6 (In-Line) – Chrome .....	\$117.30
PWAT6R2	6 (In-Line) – Black .....	122.40
PWAT6R3	6 (In-Line) – Gold .....	137.70
PWAT331L	6 (3+3) – Chrome.....	114.99
PWAT332L	6 (3+3) – Black .....	119.99
PWAT333L	6 (3+3) – Gold.....	134.99

PRICES SUBJECT TO CHANGE WITHOUT NOTICE

## SCHALLER MACHINES



ST6K



M6

### M6, ST6

MODEL	TYPE	FINISH	BUTTON	LIST
M6	3 on side	Hand Polished Chrome	Std.....	\$ 145.35
M6a (10010223)	3 on side	Mach. Polished Chrome	Std.....	107.00
M6G	3 on side	Hand Polished Gold	Std.....	203.90
M6Ga (10010523)	3 on side	Mach. Polished Gold	Std.....	183.75
M6La (10010220)	6 in line	Mach. Polished Chrome	Sml.....	107.00
M6GLa (10010520)	6 in line	Mach. Polished Gold	Sml.....	187.75
ST6 (10130123)	3 on side	Hand Polished Nickel	Sml.....	80.00
ST6L (10130120)	6 in line	Hand Polished Nickel	Sml.....	80.05
ST6K (10140123)	3 on side	Nickel Plated	Prl.....	77.25
ST6KG (10140523)	3 on side	Gold Plated	Prl.....	94.90

### M6 VINTAGE

MODEL	TYPE	FINISH	BUTTON	LIST
VM6AN (10110123)	3 + 3	Nickel	Std.....	\$98.85
VM6LAN (10110120)	6 in Line	Nickel	Std.....	98.85
VM6AC (10110223)	3 + 3	Chrome	Std.....	103.35
VM6LBBK (10110420)	6 in Line	Black	Std.....	106.95

### DA VINCI

MODEL	TYPE	FINISH	BUTTON	LIST
HS50651 (10100223)	3 + 3	Chrome	Std.....	\$124.00
HS50653 (10100423)	3 + 3	Black	Std.....	124.00
HS50851 (10100220)	6 in Line	Chrome	Std.....	124.00
HS50853 (10100420)	6 in Line	Black	Std.....	124.00

### CLASSIC

MODEL	FINISH	SHAFT	TYPE	BUTTON	LIST
HNi1 (10330152)	Nickel	Ctr Hole	Hauser	Acryl.....	\$93.10
HG1 (10330552)	Gold	Ctr Hole	Hauser	Acryl.....	103.50
LNi1 (10340152)	Nickel	Ctr Hole	Lyra	Acryl.....	96.40
LG1 (10340552)	Gold	Ctr Hole	Lyra	Acryl.....	107.10

## SCHALLER MACHINES



MNi4

### MANDOLIN

MODEL	FINISH	SHAFT	STYLE	BUTTON	LIST
MNi2 (10440155)	Nickel	Metal, Ctr Hole	A	Pearl.....	\$105.50
MNi3 (10440158)	Nickel	Metal, End Hole	A	Pearl.....	103.50
MG3 (10440558)	Gold	Metal, End Hole	A	Pearl.....	133.10
MNi4 (10440161)	Nickel	Metal, End Hole	F	Pearl.....	96.35
MG4 (10440561)	Gold	Metal, End Hole	F	Pearl.....	131.60



M6MINIA

### MINI

MODEL	TYPE	FINISH	BUTTON	LIST
M6MINIa (10040223)	3 on side	Mach. Polished Chrome	Sml.....	\$103.35
M6MINIBK (10040423)	3 on side	Black Chrome	Sml.....	106.95
M6GMINIa (10040523)	3 on side	Mach. Polished Gold	Sml.....	175.80
M6LMINIa (10040220)	6 on line	Mach. Polished Chrome	Sml.....	103.35
M6GLMINIa (10040520)	6 on line	Mach. Polished Gold	Sml.....	175.80
M6LMINIBK (10040420)	6 in line	Black Chrome	Sml.....	106.95
HS10040820	6 on side	M6 Mini Vintage Copper	Sml.....	202.90

### LOCKING

MODEL	TYPE	FINISH	BUTTON	LIST
LK6A (10090223)	3 on side	Chrome Top Lock	Std.....	\$180.90
LK6MINIBK (10080423)	3 on side	Black Top Lock	Mini.....	180.90
LK6LMINIBK (10080420)	6 on side	Black Top Lock	Mini.....	199.00
INDM6L (10060220)	6 in line	Chrome Bottom Lock	Mini.....	138.60
INDM6LBK (10060420)	6 in line	Black Bottom Lock	Mini.....	166.35
INDM6LG (10060520)	6 in line	Gold Bottom Lock	Mini.....	273.35
INDM6 (10060223)	3 on side	Chrome Bottom Lock	Std.....	143.50
INDM6BK (10060423)	3 on side	Black Bottom Lock	Std.....	166.35

### GRAND TUNE

MODEL	TYPE	FINISH	BUTTON	LIST
HS10510123	Grand Tune	Nickel 3 + 3	Vtg.....	\$169.35
HS10510223	Grand Tune	Chrome 3 + 3	Vtg.....	169.35
HS10510523	Grand Tune	Gold 3 + 3	Vtg.....	194.25



M4S



BM

### BASS

MODEL	TYPE	FINISH	LIST
M4	2 on side	Hand Polished Chrome .....	\$134.05
M4a	2 on side	Mach. Polished Chrome.....	120.45
M4BK (10290403)	2 on side	Black.....	120.45
M4Ga (10290503)	2 on side	Mach. Polished Gold.....	182.85
M4La (10290201)	4 in line	Mach. Polished Chrome.....	120.95
M4LBK (10290401)	4 in line	Black Chrome.....	124.60
BM (10250103)	2 on side	Bright Nickel Plated, Long Shaft.....	109.75
BML (10250101)	4 in line	Bright Nickel Plated, Long Shaft.....	109.75
BMC (10250203)	2 on side	Hand Polished Chrome Long Shaft.....	117.10
BMFLC (10260201)	4 in line	Chrome, Long Shaft.....	117.10
BMFLBK (10260401)	4 in line	Black Chrome, Long Shaft.....	146.80
HS10260501	4 in line	Gold Long Shaft.....	179.69
M5 (10290212)	5 string	Chrome.....	173.40
M5G (10290512)	5 string	Gold.....	268.40

www.schaller-electronic.com

(Prices may vary due to Euro/Dollar fluctuation)

## MACHINES



Deluxe classic set, gold plated with fancy inlays and butterfly buttons.  
**MM6005GO**.....\$30.00



**WD MINI BASS**  
**GB7C** Chrome, 2+2 .....\$55.00  
**GB7LC** Chrome, 4 in Line .....\$5.00  
**GB7BK** Black, 2+2 .....\$60.00  
**GB7LBK** Black, 4 in Line .....\$60.00

## GROVER PARTS



**RP601** Small Bushing.....\$12.60 dz.  
**RP4075** Wood Screws.....1.80 dz.  
**RP4078** Threaded 1/2" Bushing .....12.60 dz.  
**RP4099** 5/8" Facewasher.....5.40 dz.

### Rotomatic Bushings

**GP071** Nickel.....\$12.00 dz.  
**GP072** Chrome .....12.00 dz.  
**GP073** Black Chrome .....12.00 dz.  
**GP074** Gold .....12.00 dz.  
**GP079** Chrome – Short .....12.00 dz.

### Rotomatic Washer

**GP075** Nickel.....\$7.20 dz.  
**GP076** Chrome.....7.20 dz.  
**GP077** Black Chrome.....7.20 dz.  
**GP078** Gold.....7.20 dz.

### Imperial Bushings

**GP083** Nickel.....\$12.00 dz.  
**GP084** Chrome .....12.00 dz.

### Button Screws

**GP088** Nickel.....\$1.80 dz.  
**GP089** Chrome .....1.80 dz.  
**GP090** Gold .....1.80 dz.

### Button Nylon Washer

**GP092** Button Nylon Washer .....\$3.00 dz.

### Sta-Tite Bushings

**GP080** Nickel.....\$12.00 dz.  
**GP081** Chrome .....13.80 dz.  
**GP082** Gold .....12.00 dz.

### Wood Screws

**GP085** Nickel.....\$1.80 dz.  
**GP086** Black Chrome .....1.80 dz.  
**GP087** Gold .....1.80 dz.

### Button Spring Washer

**GP091** Button Spring Washer.....\$3.00 dz.

## HIPSHOT



## GUITAR MACHINES

Upgrade your guitar with sleek, precision built Guitar Tuning machine heads. Smooth 18:1 gear ratio. Locking or standard.

**6 IN LINE**  
**HIP6GNOC** Chrome.....\$74.95B

**6 IN LINE (LOCKING)**  
**HIP6GLOC** Chrome .....\$80.05B

## BASS EXTENDER KEYS

**HIPBT1**.....\$101.35  
 Bass Tuner for G&L Music man basses with Schaller BML pegs.

**HIPBT2** .....\$101.35

For '66 up Fender with Schaller BMFL style pegs except '82-'84 US made with special Fender pegs.

**HIPBT2BK** Black BT2.....\$101.35

**HIPBT2GO** Gold BT2 .....\$137.00

**HIPBT3** .....\$101.35  
 For pre-CBS Fender with reverse Kluson peg.

**HIPGB7**.....\$105.60  
 With enclosed gear Gotch mini-peg.

**HIPGB7BK** Black B7 .....\$116.30

**HIPGB7GO** Gold.....\$126.95

**HIPM4** .....\$105.60  
 For bass with enclosed gear mini-peg.

**HIPM4BK** Black M4 .....\$116.30

**HIPM4GO** Gold M4 .....\$126.95

**HIPB4C**.....\$101.35  
 For Peavy, etc. with half enclosed gear.

**HIPBT4** 82-84 Fender .....\$101.35  
 For Yamaha RBX



## BASS MACHINES

**HIPHB2** For '66 & up FENDER except '82 thru '84 US made with special pegs – Chrome .....\$158.40  
 Black .....168.00

## BASS MACHINES & EXTENDER

**HIPBHT1** For G&L MUSICMAN & GIBSON – Chrome.....\$220.15  
 Gold.....281.00

**HIPBHT2** For '66 & Up Fender – Chrome..\$220.15  
 Gold.....281.00



Ultralite, reversible bass machines available with clover leaf or y shaped keys.

## BASS MACHINES / SET OF 4

**ONEHB6YC** Chrome, Y Key, Single.....\$39.60  
**HIPHB6YBK** Black, Y Key .....168.00  
**HIPHB6CC** Chrome, Clover.....158.40  
**HIPHB6CGO** Gold, Clover .....192.00

## MACHINE W/EXTENDER

**HIPBHT6CC** Chrome, Clover.....\$220.15  
**HIPBHT6CBK** Black, Clover .....227.35  
**HIPBHT6CGO** Gold, Clover .....281.00



## GUITAR EXTENDER KEYS

Fits acoustic and electric. Extends low E to D.  
**HIPGT1** 3 + 3 .....\$101.35  
**HIPGT1BK** 3 + 3, black .....108.80  
**HIPGT2** 6 in line .....101.35  
**HIPGT2BK** 6 in line, black .....108.80

## GROVER PARTS ASSORTMENT

Grover Parts Tray assortment of Rotomatic bushings, Rotomatic washers, Sta-tite bushings, Imperial bushings, Wood screws, Button screws, Button spring washers, Button nylon washers.



### Rotomatic Washer

**GP075** Nickel  
**GP076** Chrome  
**GP077** Black Chrome  
**GP078** Gold

### Imperial Bushings

**GP083** Nickel  
**GP084** Chrome

### Button Screws

**GP088** Nickel  
**GP089** Black Chrome  
**GP090** Gold

### Button Nylon Washer

**GP092** Button Nylon Washer

### Sta-Tite Bushings

**GP080** Nickel  
**GP081** Chrome  
**GP082** Gold

### Wood Screws

**GP085** Nickel  
**GP086** Black Chrome  
**GP087** Gold

### Button Spring Washer

**GP091** Button Spring Washer

**GP200** .....\$222.60

## BANJO TAILPIECES



SP117

<b>BJTCR</b>	Chrome .....	<b>\$26.50</b>
<b>SM965</b>	Waverly .....	<b>49.40</b>
<b>SP110</b>	Waverly Style (Saga) .....	<b>27.25</b>
<b>SP111</b>	Clamshell Saga .....	<b>41.95</b>
<b>SP115</b>	No-Knot Style (Saga) .....	<b>27.25</b>
<b>SP117</b>	Waverly "Old Style" (Saga) .....	<b>31.45</b>

## BANJO HOOK & NUT



<b>SM0085</b>	1/4" nut .....	<b>\$1.65</b>
<b>SM0087</b>	5/16" nut .....	<b>2.60</b>
<b>SM0088</b>	Round hook .....	<b>1.20</b>

## BANJO WRENCHES/MUTE



Nickel plated wrenches with hexagon hole.

<b>SM852</b>	1/4" Hex .....	<b>\$11.25</b>
<b>SM850</b>	5/16" Hex .....	<b>11.25</b>
<b>SP180</b>	Mute, Nickel .....	<b>15.75</b>

## BANJO ARM REST



<b>SM1002</b>	Stewart MacDonald (24 Bkt) .....	<b>\$66.20</b>
<b>SP100</b>	Saga (24 Bkt) .....	<b>20.95</b>
<b>SP104</b>	Brass, Nickel Plated .....	<b>36.70</b>

## MANDOLIN TAILPIECES



SM131

<b>SM735</b>	Chrome .....	<b>\$30.80</b>
<b>SM735G</b>	Gold .....	<b>43.45</b>
<b>SM130</b>	Nickel .....	<b>8.35</b>
<b>SM131</b>	Nickel .....	<b>10.45</b>
<b>SM132</b>	Gold .....	<b>26.20</b>
<b>SM133</b>	Stainless Steel, 2 Piece .....	<b>14.65</b>
<b>SM731</b>	Chrome, Clam Shell .....	<b>26.85</b>
<b>MANDTLCR</b>	Chrome .....	<b>16.00</b>
<b>MANDTLGD</b>	Gold .....	<b>28.00</b>

## SCHALLER BANJO PEGS



<b>B4</b>	(10410100) Planetary, Nickel Plated .....	<b>\$131.60/4</b>
<b>B4C</b>	(10410200) Planetary, Chrome Plated .....	<b>131.60/4</b>
<b>B4G</b>	(10410500) Planetary, Gold Plated .....	<b>178.05/4</b>
<b>895</b>	(10400100) 5th Peg, Self-Locking, Nickel .....	<b>30.78 ea.</b>
<b>895C</b>	(10400200) 5th Peg, Self-Locking, Chrome .....	<b>32.75 ea.</b>
<b>895G</b>	(10400500) 5th Peg, Self Locking, Gold .....	<b>37.80 ea.</b>
<b>6101113</b>	(11504100) White Banjo Button .....	<b>9.50</b>

## STA-TITE PATENT PEGS



Will fit any banjo headpiece from 7/16" up to 5/8" thickness.

<b>870</b>	Tenor banjo/dulcimer .....	<b>\$47.95</b>
<b>872</b>	5th Peg .....	<b>15.50</b>
<b>123C</b>	Tenor, Chrome Geared, Grover .....	<b>109.50</b>
<b>SM5017</b>	4 Geared 1 Friction .....	<b>29.00</b>

## MANDOLIN MACHINES



<b>A STYLE</b>	Chrome, chrome buttons .....	<b>\$33.49</b>
<b>P2694</b>	Nickel, plastic buttons .....	<b>20.99</b>
<b>P2695</b>	Gold, Pearlloid buttons .....	<b>44.99</b>
<b>P2696</b>	Gold, Pearlloid buttons .....	<b>44.99</b>
<b>WD1282</b>	Nickel plated, plastic buttons .....	<b>32.00</b>
<b>304C</b>	Chrome w/metal buttons .....	<b>39.95</b>
<b>SM120</b>	Economy .....	<b>22.00</b>
<b>GT120N</b>	Nickel Plated .....	<b>55.45</b>
<b>WD1283</b>	Gold/Pearl Button .....	<b>47.50</b>
<b>WD1284</b>	Gold/ Blk., Pearl Button .....	<b>46.50</b>
<b>309N</b>	Nickel Plated .....	<b>98.50</b>
<b>309G</b>	Gold Plated .....	<b>120.15</b>

<b>F STYLE</b>	Nickel Plated .....	<b>\$88.65</b>
<b>309FN</b>	Gold Plated .....	<b>120.15</b>
<b>309FG</b>	Gold Plated .....	<b>120.15</b>
<b>309FVN</b>	Nickel Plated Vintage .....	<b>88.65</b>
<b>GT160N</b>	Nickel .....	<b>96.85</b>
<b>GT160G</b>	Gold .....	<b>133.40</b>
<b>MANDFGD</b>	Gold .....	<b>85.00</b>
<b>SFM3</b>	Embossed Gold .....	<b>41.95</b>

## STA-TITE UKE PEGS



<b>4B</b>	Nickel w/Black Button .....	<b>\$30.50</b>
<b>4W</b>	Nickel w/White Button .....	<b>30.50</b>
<b>4BG</b>	Gold w/Black Button .....	<b>48.95</b>
<b>4WG</b>	Gold w/ White Button .....	<b>48.95</b>
<b>6B</b>	Nickel w/Black Button .....	<b>30.50</b>
<b>6W</b>	Nickel w/White Button .....	<b>30.50</b>

## SCHALLER D TUNERS



<b>896</b>	(10420100) Changes Pitch, Nickel .....	<b>\$144.15/2</b>
<b>896C</b>	(10420200) Changes Pitch, Chrome .....	<b>153.65/2</b>
<b>896G</b>	(10420500) Changes Pitch, Gold .....	<b>181.45/2</b>

## BANJO PEGS



<b>STM501</b>	5* Planet, nickel set of 4 with pearloid buttons .....	<b>\$170.10</b>
<b>BJ5TCR</b>	Planet geared, set of 5 .....	<b>135.00</b>
<b>GT240N</b>	Nickel, set of 4 Planet .....	<b>205.70</b>

## CHAMPION BANJO PEGS



Provides positive non-slip action and will last a lifetime.

<b>75B</b>	Tenor banjo .....	<b>\$41.50</b>
<b>25B</b>	Banjo .....	<b>52.50</b>

## BANJO 5TH PEGS



116N

<b>162C</b>	Chrome, Metal Button, Geared .....	<b>\$34.50</b>
<b>163C</b>	Chrome, Pearl Button, Geared .....	<b>34.50</b>
<b>SP142</b>	Saga, Geared .....	<b>8.35</b>
<b>GT250N</b>	Nickel, Geared .....	<b>28.50</b>
<b>SM33</b>	Nickel, 5-Star .....	<b>29.90</b>
<b>164C</b>	Chrome, Round Button Geared .....	<b>34.50</b>
<b>164G</b>	Gold, Round Button Geared .....	<b>49.95</b>
<b>116N</b>	Nickel .....	<b>10.50</b>

## JUNIOR UKE



<b>2B</b>	Junior Uke .....	<b>\$11.95 set</b>
<b>3B</b>	Deluxe, Black .....	<b>14.50 set</b>
<b>3W</b>	Deluxe, White .....	<b>14.50 set</b>

## CHAMPION UKE PEGS



<b>85B</b>	Uke .....	<b>\$40.50 set</b>
<b>88B</b>	Bari Uke .....	<b>41.50 set</b>
<b>UNP</b>	Schaller .....	<b>11.20 ea.</b>
<b>P2698</b>	Ping, non slip .....	<b>17.99 set</b>
<b>P2699</b>	Ping, geared .....	<b>17.99 set</b>
<b>8N</b>	Uke, geared, Grover .....	<b>20.50 set</b>

## STRING SWING



5-Instrument Hanger System

**SW5RL** .....\$94.47  
 (Color options: Black Vein (BV), Copper Vein (CV) & Silver Vein (SV)  
 (Yoke options: B, BG, C, D, HD, K, UK, V, VNB, VS, VSNB)



Shadowbox Guitar Frame

**CC56** .....\$44.97  
 (Color options: Black (BK), Ash (A), Oak (O), Cherry (C), Black Walnut (BW)



**CC37A** .....\$29.97  
 Flat-folding Floor Stand – Acoustic

**CC37E** .....\$29.29  
 Flat-folding Floor Stand – Electric



Furniture Quality, Solid Wood – Acoustic

**CC53** For ukulele, mandolin, or violin, string swing floor stand padded steel.....\$ 23.99  
**CC22** Hardwood string swing .....87.50B



CC109

Oak Island Rack. Holds 12 wide body or 16 narrow body guitars.

**CC109** .....\$480.00

**CC34** Side-loading, inline guitar rack, holds up to 6 guitars .....119.99

## STYLZ STRING SWING



K2

K5

The **CC01K** with **STYLZ**

**ST01K1** Digi-Camo .....\$16.50  
**ST01K2** Eternity .....16.50  
**ST01K3** Feelings.....16.50  
**ST01K4** Jazz .....16.50  
**ST01K5** Blues .....16.50  
**ST01K6** Torn .....16.50

## GRIP STUDIOS

**WALL MOUNT HOLDERS**  
 Machined and balanced so your instrument fits securely.

**FEMALE HAND STANDS**  
 (Face Left)



**LHGH118** Purple Sparkle (Female).....\$47.95  
**LHGH119** Pink Sparkle (Female) .....47.95  
**LHGH120** Silver Sparkle (Female) .....47.95  
**LHGH121** Ocean Turquoise (Female).....47.95  
**LHGH122** Lake Placid Blue (Female) .....47.95  
**LHGH123** Shoreline Gold (Female) .....47.95  
**LHGH101** Metal Mayhem .....47.99  
**RHGH101R** Metal Mayhem .....47.99  
**LHGH102** Red Rum .....47.99  
**RHGH102R** Red Rum .....47.95  
**LHGH106** Black Pearl.....47.99  
**RHGH106R** Black Pearl.....47.95  
**LHGH104** Pearlized White.....47.99  
**RHGH104R** Pearlized White.....47.95  
**LHGH105** PennyWise .....47.99  
**RHGH105R** PennyWise.....47.95  
**LHGH111** Bluester .....47.95  
**RHGH111R** Bluester .....47.95  
**LHGH125** Gold Top .....47.95  
**RHGH125R** Gold Top .....47.95

**AXCENT SERIES**

**LHGH103** Grip Reaper.....\$48.95  
**LHGH107** Monster-Green .....48.95  
**LHGH108** Monster-Red .....48.95  
**LHGH114** Bella Rose .....55.00B  
**LHGH115** Ent-Wistle .....55.00B  
**LHGH117** Torch Tip Black/Silver.....55.00B

**LUMPY STUMPY**

**GH114** .....\$39.99



**Mounts on wall, supports instrument.**

**CC01** Wood Bracket.....\$14.40  
**CC02** Steel Bracket .....14.10  
**CC01K** Home/Studio .....14.25  
**CC02K** Home/Studio .....14.25  
**SDY03** CC03 Yoke .....4.80



**CC05** Straps on amp handle .....\$16.20

**Clips on side mount handles.**

**CC06** Round Handles .....\$12.90  
**CC07** Flat Handles .....12.90

(See String Swing Section too)

**Metal version of CC01**

**CC11W** Wide Body White.....\$14.10  
**CC11BK** Wide Body Black .....14.10  
**CCN11W** Narrow Body White .....14.10  
**CCN11B** Narrow Body Black .....14.10  
**CC01B** Banjo, Wood Bracket .....14.70  
**CC03RL3B** Banjo, Multi Facing .....17.10  
**CC01V** Violin w/Bow Holder .....14.70  
**CC01UK** Uke/Mandolin Holder .....14.70  
**CC01D** Dulcimer Holder .....14.70  
**CC01N** Narrow Body.....13.65



**Mounts on MIC stand/music stand**

**CC04** Guitar Holder .....\$15.00  
**CC04TWNV** 2 Violin Hanger.....16.50



CC03LLBK

**Mounts on Slot Rail/Wall**

**SRSSR** Right, 30° Angle .....\$15.60  
**CC03F2BK** Front .....11.70  
**CC03RR** Right, 65° Angle .....15.60  
**CC03LLBK** Left, 65° Angle .....15.60  
**CC101** Keeper Strap ..... .96

**Slatwall/Gridwall**

**CC03FW** Front, 30° Angle, White .....\$11.70  
**CC03RW** Right, 30° Angle, White .....13.70  
**CC03F2UK** 2" Stem Uke/Mandolin Hanger..11.70  
**CC03F4UK** 4" Stem Uke/Mandolin Hanger 12.30  
**WASHER** Locks Guitar on Hook......50  
**CC03MA5BK** 5" Multi Angle .....15.90  
**CC03MA8BK** 8" Multi Angle.....16.50

## PEAVEY GUITAR HANGER



**03011440** Electric or Acoustic.....\$10.99B  
**03011450** Electric, Acoustic or Bass Guitars .....12.99B

www.stringswing.com

# GUITAR STANDS

## STAGELINE



### STAGELINE SAFE T CRADLE

Durable steel construction.

**GS515Q** Acoustic.....\$32.85

**GS514Q** Electric.....32.85

## KM



**KM17580** Heli Acoustic.....\$27.99

**KM17581** Heli Electric.....31.99



**KM17550** Memphis Travel.....\$35.00  
The adjustable support arms mean the stand can be used for electric or acoustic guitars. The non-marring plastic material protects the guitar from damage.

## ON/STAGE



### ON/STAGE

#### 3-SPACE FOLDABLE MULTI GUITAR STAND

**GS7361** On-Stage.....\$75.99

Holds 2 acoustics + 1 electric, or other combinations of electric and acoustic guitars. Black velveteen rubber. A stable, balanced stand no matter how many slots are full. Folding design for easy transport.

**GS7561** Same as above, 5 space Guitar Rack, On Stage.....89.99

## ON/STAGE



### ON/STAGE

#### TUBULAR GUITAR STANDS

All come w/security strap lock.

**XCG4** Black, Single.....\$22.99

**GS7121BXCG** Black, Deluxe Single.....29.99

**GS7252BDUO** Black, Double.....52.99

**GS7352BTRI** Black, Triple.....62.99

#### Hang-It™ ProGrip™II Guitar Stand

**GS8200** Black, Auto-locking Yoke.....\$59.99

**GS7730** Mini Wood Wall Hanger.....22.99

## ON/STAGE



### ON/STAGE

#### FLIP-IT® GRAN GUITAR STANDS

**GS7153BB** Black, Single.....\$44.99

**GS7253BB** Black, Double.....72.99

**GS7353BB** Black, Triple.....89.99

#### Pro Flip-It!® A-Frame Stand

**GS7465B** Black, Acoustic or Electric.....\$44.99

## ON/STAGE



### ON/STAGE

#### A-FRAME STANDS

**GS7362B** Black, Single Acoustic or Electric.....\$37.99

**GS7462B** Black, Pro Single Acoustic or Electric.....42.99

**GS5000** Fold-Flat Folk Instrument Stand.....17.99  
The GS5000 Fold-Flat Small Instrument Stand is sized just right for ukulele, fiddle/violin, viola, mandolin, lap steel guitar and dulcimer.

**GS6000B** Mighty Uke Folding Instrument Stand.....29.99  
The GS6000B is designed for small stringed instruments like ukulele, mandolin, fiddle/violin, and dulcimer.

**GS7655** Fold-Flat A-Frame Guitar Stand.....26.99  
The 5-positions and stepped yoke design accommodate most standard shapes and sizes of guitars.

**GS6500** The Mighty Guitar Stand.....40.99  
Can handle electric, hollow body electric, semi-acoustic, dreadnaught, classical, bass, and ¾ size guitars.

# ULTIMATE GUITAR STANDS



- UGS55** A Style Electric or Acoustic...**\$39.99B**
- UGS100** Hanging .....**49.99B**
- UGS200** Cradle .....**49.99B**
- UGS1000** Genesis .....**59.99B**
- Hanging w/self closing yolk
- UGS10WPRO** Guitar Wall Mount.....**39.99B**
- UGS10SPRO** Guitar Slat Wall Mount.....**39.99B**
- Genesis Series Guitar Hanger with Self-closing Style Yoke and Slatwall Mount & Wall Mount
- UGS10W** Guitar Wall Mount.....**29.99B**
- Genesis Series Guitar Hanger with Safety Strap Style Yoke and Wall Mount
- UGS10S** Guitar Slat Wall Mount.....**29.99B**
- Genesis Series Guitar Hanger with Safety Strap Style Yoke and Slat Wall Mount

# GUITAR STANDS



- HANGING GUITAR STANDS**
- GS2438** Single, Black .....**\$33.35**
  - 290B** Double, Black .....**49.99**
  - 390B** Triple, Black .....**54.99**
  - KB38** Hamilton, Single .....**45.99**
  - KB38BK** Hamilton, Black .....**45.99**
  - KB3000G** Hamilton, Black, "The Hanger" .....**32.99**
  - KM17670** Pro Model, Black .....**50.00**
  - KM17620** Double, Black .....**99.99**



- TUBULAR GUITAR STANDS**
- GST437** Black, Lock Top Hosa .....**\$16.75**
  - GS100B** Black, w/Black Foam .....**21.99**
  - GS2457BK** Black w/Security Lock.....**27.99**
  - GS2445** Chrome, Top .....**24.99**
  - GS2445BK** Black, Top .....**21.99**



- QUIK LOK**
- AMSGS436** A Frame Electric .....**\$26.65**
  - AMSGS437** A Frame Acoustic.....**26.65**
  - AMSQ692** Universal .....**39.99**



- Durable steel construction, push button adjustment.
- KM1754BK** Black, Electric .....**\$50.00**
  - KM17541B** Black, Acoustic .....**55.00**
  - KM16150** Stand Clamp Holder .....**35.99**
  - CC25** String Swing Metal Floor Stand.....**60.00**



- HAMILTON**
- KB916** Black, Flip Top, Foam .....**\$16.00**
  - KB918** Black, Fixed Top, Foam .....**16.00**
  - KB40** Black, Grabbit Gtr .....**35.99**
  - KB5000G** Black, A Frame, Acoustic/Electric..**34.99**
  - KB303G** Black, Cradle Stand Lock Top .....**22.99**



- STAGELINE**  
Vibrant colored guitar stand in the fixed neck style. Foam rubber padding. Safety strap.
- GS120** Chrome .....**\$27.99**
  - GS120PUR** Purple .....**29.99**
  - GS120DBL** Dark Blue .....**29.99**
  - GS120GN** Green.....**29.99**



- QUIK LOK**
- AMSGS430** 3 Guitar .....**\$119.99**
  - AMSGS450** 5 Guitar.....**146.65**



- FENDER**
- FEN1809** Electric Gig Stand .....**\$29.99**  
Durable Injection-Molded Construction
  - FEN1811** Electric Mini.....**18.75**
  - FEN1812** Acoustic Mini .....**25.00**

PRICES AND SPECIFICATIONS SUBJECT TO CHANGE WITHOUT NOTICE



# HERCULES GUITAR STANDS



### TRIPLE GUITAR

The Tri AGS stand is designed to safely support three guitars or basses. The stand features three AGS yokes with SFF rubber designed to fold down for packing.

**GS432B** .....\$144.99



### DOUBLE GUITAR

The Duo AGS stand is designed to safely support two guitars or basses. It features two AGS yokes with SFF rubber designed to fold down for packing.

**GS422B** .....\$117.99



### AUTO GRAB WITH FOLDING YOKE

The single AGS guitar stand features our patented AGS yoke with SFF rubber designed to fold down for packing. Hand Grip Height Adjuster, and back rest with SFF rubber on the legs.

**GS415B** .....\$68.99  
**HA201** System Lock .....\$68.00



### SINGLE WITH SPECIAL FORMULA FINISH ON LEGS

The Single AGS guitar stand features our patented AGS yoke with SFF rubber, Hand Grip Height Adjuster, and back rest with SFF rubber on the legs.

**GS414B** .....\$70.99  
**GS454B** Classical .....\$60.99



### SINGLE WITH ADJUSTABLE BACK REST

The Single AGS guitar stand features our patented AGS yoke with SFF rubber. Hand Grip Height Adjuster, and an adjustable back rest.

**GS412B** .....\$75.99  
**GSB001** Bag for 412B, 414B, 415B .....\$21.99



### SINGLE, SHOCK PROOF (GUITAR/BASS)

Offers a specific Shoksafe tilting post and Secure Retention System upper yoke to guard against inevitable stage collision and bump. It also features our patented foldable upper/lower yokes with SFF rubber designed for compact storage.

**GS405B** .....\$84.99



**GS401BB**

### MINI STANDS SPACE SAVERS

**GS401BB** Acoustic .....\$61.99  
**GS402BB** Electric .....\$61.99



### MULTI GUITAR STAND

6 folding Auto Grip System yokes. Suitable for store display. Folding backrests. Specially formulated Foam.

**GS526B** 6 Place Folding Yoke Display Stand.....\$171.99



### STAGELINE

Round Guitar Rack. For narrow body guitars.

**GSD6E** Holds 6 (Import) .....\$93.00



**GSP39WB**

**GSP40SB**

**GSP40WB**

### HANGERS

#### Guitar Hangers

**GSP40SB** Slatwall .....\$39.99  
**GSP39SB** Statwall Short .....\$39.99  
**GSP40WB** Wallmount – Long .....\$39.99  
**GSP39WB** Wallmount – Short.....\$39.99  
**GSP38WB** Consumer Wood Wall Hook .....\$39.99  
**GSP28WB** Classic Guitar .....\$32.99  
**GSP29WB** Universal Yoke .....\$37.99

For acoustic guitar, classical guitar, banjo, electric guitar, electric bass.

*Home Series Stands Feature Wood Grain Finish*

# DIXON-MANTIS SERIES GUITAR STANDS



<b>A FRAME</b>	
SSGM1A	Acoustic .....\$28.20
SSGM1E	Electric.....28.85



<b>WALL HOLDERS</b>	
SSGAHC	Front/Right Facing.....\$15.99
SSGAHS	Swivel Adjust.....16.79



<b>A FRAME QUAD LEG</b>	
SSGM2A	Acoustic .....\$29.39
SSGM2E	Electric.....29.39

## HERCULES



Opens or folds flat in a single step.

GS301B	Acoustic .....\$38.99
GS302B	Electric.....38.99
GS303B	Folk Instrument .....36.99

For Banjos, Mandolins, Ukuleles and Violins

## JOHNSON



<b>A FRAME GUITAR STAND</b>	
Steel construction, easy-open design, fits acoustics and electrics.	
SG095	.....\$12.75

## KM



Guitar Performer stands in black.

KM14761	Acoustic .....\$379.99
KM14760	Electric.....379.99

## MULTI GUITAR STANDS



SG303	Holds 3 .....\$53.50
SG305	Holds 5 .....89.10
CC27	Holds 3, String Swing.....95.97

## KM



KM17590	Electric.....\$19.99
KM17591	Acoustic .....19.99

## GUITAR HOOKS



### SWIVEL SECURITY GUITAR HOLDERS

Holds guitar in either left, right or front facing position. The "Security Lock" mechanism is added to keep those electric guitars with the unique head-stock shapes from slipping out of the hook. Yoke is padded. Fits pegboard, slatwall or slat-style grid.

2235A	Chrome .....\$14.65
2235ABK	Black .....13.50

### SWIVEL, BLACK

KB920	Pegboard, 9" Long, Acoustic .....\$9.99
KB922	Slatwall, 9" long, Acoustic.....9.99
KB924	Pegboard, 4.5" long, Electric .....9.99
KB926	Slatwall, 4.5" long, Electric .....9.99

### GRABAXE SAFE STRAP

GA100	Secures Guitar to Amp .....\$21.15
-------	------------------------------------

### COVERS

HB1	Guitar hook cover (cloth) .....\$6.60
SA10HC	Leather, Black, 10 Pk.....13.30

## MULTI GUITAR STANDS



<b>HERCULES</b>	
GS523B	Holds 3.....\$116.99
GS525B	Holds 5 .....137.99
HA205	Rack Extension Pack .....13.99 pk. Includes 1 yoke and two rings



<b>K&amp;M</b>	
KM17513	Holds 3.....\$249.99
KM17604	Roadie, Holds 4 .....219.99

# TREE WORKS CHIMES

MADE IN THE U.S.A.



**69 Bar Zentree**  
Aluminum/Titanium Alloy Bars  
**TREZEN** .....\$334.00

**Triangle Tree**  
3, 4, 5 & 6 Inch Triangles  
**TRE04TT** .....\$166.00

**Bi-Angle Tree**  
Tree Works chimes, 6", 9" & 12" V-shaped high carbon steel, extremely hard.  
**TRE04TTV**.....\$166.00

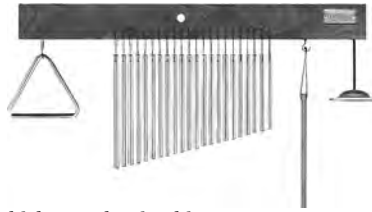

**22 Thick Bar Classic Chime**  
Single Row with Triangle and Finger Cymbal  
**TRE24** .....\$200.00

**42 Thick Bar Classic Chime**  
Double Row with Triangle and Finger Cymbal  
**TRE24DB** .....\$334.00

**31 Thick Bar Classic Chime**  
Single Row with Triangle and Finger Cymbal  
**TRE416** .....\$210.00



**14 Thin Bar Classic Chime Single Row**  
**TRE417** Single Row .....\$83.00



**35 Thick Bar Classic Chime Single Row**  
**TRE35** .....\$200.00  
**TRE35RC** Flat Bar .....200.00  
**TRE630** W/Damper & Case .....283.00



**69 Thick Bar Classic Chime Double Row**  
**TRE35DB** .....\$334.00  
**TRECOIL** Coil Chime .....116.00



**Alternate Tuning 35 Bar Single Row**  
**TRE35XO** .....\$200.00  
**Chorus Effect Tuning**  
**TRE555** .....\$234.00

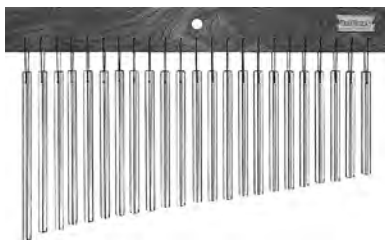

**23 Thin Bar Classic Chime Single Row**  
**TRE23** .....\$150.00  
**TRE20** 20 Bar, White Ash.....116.00



**45 Thick Bar Classic Chime Double Row**  
**TRE23DB** .....\$250.00

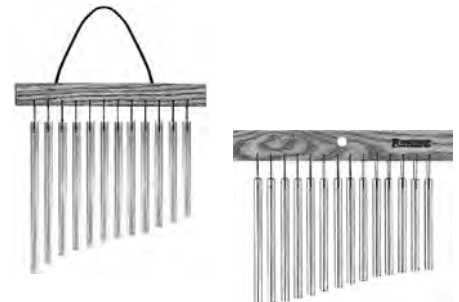

**MICRO TREES**  
**TRE417** Single-row 14 Bar Chime.....\$83.00  
**TRE415** Hand Held, 12 Bar .....61.00  
**TRE10DB** Double-row 19 Bar Chime .....116.00

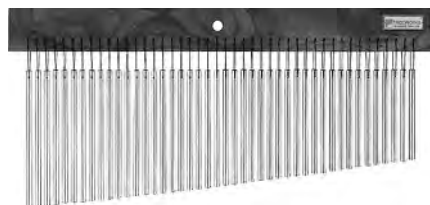

**44 Thin Bar Studio Chime**  
**TRE44** .....\$225.00  
**TRE418** Small Cluster .....\$50.00  
**TRE419** Large Cluster.....90.00

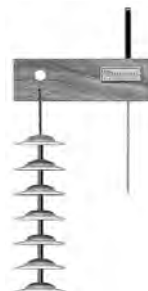

**Finger Cymbal Tree**  
7 Cymbals with Beater  
**TRE01** .....\$133.00

**Bi Angle Tree**  
**TRE04TTV** .....\$166.00

**TRE6V** 6" V.....\$34.00  
**TRE9V** 9" V.....42.00  
**TRE12V** 12" V.....50.00

**ACCESSORIES**

- TRE54** Chime Damper 24" .....\$83.00
- TRE51** Hard Side Gig Bag 26" .....66.00
- LG24** Padded Soft Case 23" .....45.00
- MD18** Padded Soft Case 17" .....42.00
- TRE52** Chime Bracket.....41.00
- FC02** Finger Cymbals .....34.00
- TREXL** Padded Soft Case 30" .....48.00



**28 Thin Bar Studio Chime**  
**TRE28** .....\$159.00



**Table Chimes**  
**TRE421** w/Stand.....\$116.00  
**TRE420** 3 Tone.....42.00

## RHYTHM TECH BAR CHIMES



Rhythm Tech Single Bar Chimes feature 20 bars in 10 pitches. The Double set holds 40 bars.

**RT8100** Single .....\$96.95  
**RT8102** Double.....140.95

### OAK WOOD

**RT8500** Single .....\$96.95  
**RT8502** Double.....141.95

### STUDIO

**RT8120** Single 10 Bar.....\$50.95  
**RT8122** Double 20 Bar.....85.95

### OAK WOOD

**RT8600** Single 10 Bar.....\$50.95  
**RT8602** Double 20 Bar.....85.95

## LP BAR CHIMES



25 solid bar, aluminum alloy.

**LP449** .....\$144.00  
**LP449C** Concert .....144.00  
**LP515** Double Row .....240.00



36 solid studio bar, aluminum alloy chimes.

**LP511** .....\$196.00  
**LP513** Double Row .....283.00  
**LP2536** Double Bar, Folding ..210.00  
**LP236D** Mount .....37.00  
**DAN525** Chime Holder .....44.25  
**UPMTA** Chime Holder .....29.95  
**UPCS** Chime Strings .....9.25/12  
**LP453** Chime Bracket.....26.00

## BAR BELLS



14 solid brass bells.  
**RT8300** Rhythm Tech .....\$154.95  
**LP450** 26 Bells .....427.00

## LP BELL HAND HELD

7" Hand Held features a solid wood handle and metal striker.  
**LP589** Hand Held, 14 Bell ...\$188.00

## GROVER PRO PERCUSSION

Spectrasound™ Bar Chimes  
 35 bars – brass hollow tube, delicate microtonal "shimmer"

**SM1** .....\$216.00B

Spectrasound is the ONLY COMPANY to use highly durable Kevlar bar ties (damper bar sold separately) 35 bars – solid aluminum, full range "sweep"

**SM7** .....\$171.00B

Damper Bar for SM1 or SM7

**SMD35** .....\$36.00B

## CP BAR CHIMES



24 Solid Bars.  
**LPA280** .....\$109.00

## CHIMES



**LP468** Hand Chimes .....\$60.00

### TREE WORKS CHIMES

**TRE418** Small .....\$50.00  
**TRE419** Large.....90.00



Includes wooden mallet.

**TROT3** Revelry.....\$25.95

**TROT4** Post Time .....34.95

### TREE WORKS

**TRE410** Single Note .....\$20.00

**TRE420** 3 Tone .....42.00

**TRE430** 5-note Tabletop .....55.00

## TRIANGLES

### GROVER PRO PERCUSSION

No strikers w/triangles

**TRB4** 4" Piccolo, Bronze .....\$53.00B  
**TRB5** 5" Concert, Bronze .....55.00B  
**TRB6** 6" Concert, Bronze .....57.00B  
**TRB7** 7" Symphony, Bronze .....59.00B  
**TRB8** 8" Symphony, Bronze .....61.00B  
**TRB9** 9" Symphony, Bronze .....63.00B  
**TR5** 5" Super-Overtone w/bag .....88.00\*  
**TR6** 6" Super-Overtone w/bag .....90.00\*  
**TR9** 9" Super-Overtone w/bag .....98.00\*  
**TRBPH6** 6" Bronze Pro Hammered Triangle w/bag.....194.00\*  
**TRBPH7** 7" Bronze Pro Hammered Triangle w/bag.....199.00\*  
**TRBPH8** 8" Bronze Pro Hammered Triangle w/ bag .....204.00\*  
**S2TBSSET** 3-Piece Beater Set .....29.00B  
**TBS** 6-Piece Beater Set .....64.00\*  
**S2TC** Clip .....16.00B  
**TBCSE** Tri Beater Case.....23.00\*  
**CTS** Up to 6", Small Triangle Bag .....21.00\*  
**CTL** Up to 9", Large Triangle Bag .....21.00\*  
**PTC** Pro Triangle Clip .....32.00B  
**DTM** Dual Triangle Mount .....58.00B

\* Call for Cost

### DUPLEX W/STRIKER

**3504** 4" .....\$4.50  
**3505** 5" .....4.75  
**3516** 6" .....5.55  
**3518** 8" .....7.80

### LP ASPIRE TRIANGLES W/STRIKER

**LPA121** 6" .....\$25.00  
**LPA122** 8" .....29.00  
**LPA123** 10" .....35.00

### DANMAR W/BEATER

**DAN404** 4" .....\$20.25  
**DAN405** 5" .....23.25  
**DAN406** 6" .....26.25  
**DAN408** 8" .....32.25  
**DAN410** 10" .....36.75

### TOCA W/STRIKER

**T2509** 6" .....\$18.20  
**T3769** 6" .....9.99  
**T3789** 8" .....10.99  
**T37109** 10" .....9.00



### LATIN PERCUSSION

**LP311A** 4" .....\$42.00  
**LP311B** 5" .....44.00  
**LP311C** 6" .....46.00  
**LP311H** Hand Held .....57.00  
**LP310** Holder .....16.00



### RHYTHM TECH

Trigger triangle allows more speed and precision.

**RT6000** .....\$45.95

**RTSUS** Suspension Rings .....3.10

**RT6005** 5" .....20.95

**RT6006** 6" .....23.95



### TRIGGER MOUNT

Magnetic disk mount for RT6000

**RT7960** .....\$19.95

### CANNON W/BEATER & HOLDER

**UP6T** 6" .....\$27.00  
**UP8T** 8" .....32.00

### TREE WORKS W/BEATER

**TREHS04** 4" .....\$34.00  
**TREHS05** 5" .....42.00  
**TREHS06** 6" .....50.00  
**TREHS08** 8" .....66.00  
**TREHS10** 10" .....83.00  
**TRE1D** 1 Dimensional Double Triangle .....48.00  
**TRE3D** 3 Dimensional Triangle .....66.00  
**TRE8I** Steeple Triangle .....83.00

### FIRTH CONCERT W/BEATER & CLIP

**V508** .....\$39.90



## TRIANGLE ACCESSORIES

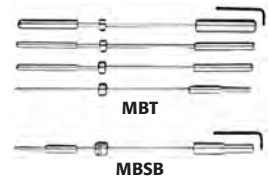

### TRIANGLE HOLDERS/MALLETS

Unique triangle holder enables percussionist to play single figures or sustained roll.

**DAN506** Mallet Set .....\$21.75

**DAN20B** Triangle Holder .....32.85

**TRE53** Mount .....41.00

**DAN527** Spring Clamp Holder .....12.00

**S2TC** ABS Triangle Clip .....15.00B

**K4121** Striker .....5.45

**MBTB** Set of Four Mallets .....110.00

**MBSB** Four in One Mallet .....44.00

**ADTAB** Set of Four Mallets .....82.50B

**TBD** Deluxe Alloy Beaters .....100.00\*

**TBTD** Deluxe Tubular Beaters .....100.00\*

**TBTS** Standard Tubular Beaters .....64.00\*

**TRE03BTR** 3 Asst. Beaters .....34.00

### BLACK SWAMP TRIANGLES & ACCESSORIES

**BSAT6** 6" Artisan Triangle (Steel) .....\$126.00\*

**BSAT8** 8" Artisan Triangle (Steel) .....132.00\*

**BSATSB** Small Triangle Bag, fits up to 8" .....22.00\*

**BSATLB** Large Triangle Bag, fits up to 10" .....24.00\*

**BSTRHANG** Triangle Holder .....\$59.00\*

**BSTRCLIP** Triangle Clip .....84.00\*

**BSTGP** Triangle Gig Pack .....67.00\*

**BSSET3** 3 Beaters with case .....92.00\*

Single Set of Select Beaters

**BSSET6** 6 Beaters with case .....176.00\*

Double Set of Select Beaters

**BSSPSET1** Set of 3 Beaters with Case.....110.00\*

Single Set of Spectrum Beaters

**BSSPSET2** Set of 6 Beaters with Case.....213.00\*

Double Set of Spectrum Beaters

\* Call for Cost

# GUIDE TO THE PRICE LIST

## CYMBAL ORGANIZATION

### Cymbal Type

Cymbals in each series are arranged in columns by type — Rides, Crashes, HiHats, and Special Effects to help you see at a glance the breadth of choices in each range.

### Cymbal Weight /Diameter

Cymbal weights and diameters are among the basic cymbal characteristics that all drummers rely on when defining their own voice.

Within each model listing, cymbals are organized by diameter — from smallest (the shortest sustain) to largest (the longest sustain).

## PRICING

MSRP  
Manufacturer's  
Suggested Retail Pricing

MAP  
Minimum Advertised Price



## CYMBAL FINISHES

### Cymbal Finishes

Zildjian cymbals are available in four finishes:

**T** Traditional — The lathing process is the final step in the manufacturing of these cymbals.\* Their unaltered tonal grooves provide a pure, full sound and a classic Zildjian look.

**B** Brilliant — High-speed buffing smooths out the tonal grooves in these cymbals. They feature a natural gold color and a slightly warmer, smoother sound that some drummers prefer.

**S** Satin — A proprietary process is used to achieve a cross between brilliant and traditional finish.

**N** Natural — Raw, unfinished cosmetic appearance.

\*Due to the organic nature of our alloy, unlathed portions of our cymbals may show natural blemishes or discolorations that would normally be removed during the lathing process. These markings do not affect the sound or the quality of the cymbal in any way.

## MODEL DESCRIPTIONS

### Model Name

Zildjian cymbal model names often reference unique characteristics of weight, diameter, shape, hammering, finishing or other design details. Some names are over 70 years old.

### Best Sellers

Products that become best sellers year after year have a red star (\*).

### New/Re-released Models

These products are highlighted in **orange**.

## CYMBAL RIVETS

All Zildjian cymbals may be ordered with rivets. Rivets produce a sustained "sizzle" sound, always popular in jazz and increasingly popular in other genres of music.

### Special Orders

Rivets (nickel plated steel) can be ordered in two configurations:

**Traditional** — The classic rivet pattern includes six rivets spaced evenly around the perimeter of the cymbal about 1-1/2" from the cymbal edge.

**Three-Rivet Cluster** — One group of three rivets, spaced about 1-1/2" from the cymbal edge and about 1" apart. Provides a subtle, more controlled sizzle sound.



# BOX SETS

# BOX SETS

The best value on our best selling cymbals across all lines: ZBT, ZHT, A and K. We've carefully selected the best combination of cymbals in each set, from our ZBTS3P-9 box set, that introduces drummers to the Zildjian family of cymbals, to our ZHT, A, and K box sets, designed for drummers who are ready to move up the line.

\*\* Added Value

\* New Pricing  
Effective March 1st

## K ZILDJIAN

SZ PART# MSRP MAP

### K Zildjian Box Set

4 CYMBAL SET-UP  
14" K HiHats  
16" K Dark Thin Crash  
18" K Dark Thin Crash\*\*  
20" K Ride

K0800 \$2,282  
**SPECIAL MAP \$899<sup>95</sup>**

## K CUSTOM

### K Custom Hybrid Box Set

4 CYMBAL SET-UP  
14 1/4" K Custom Hybrid HiHats  
17" K Custom Hybrid Crash\*\*  
21" K Custom Hybrid Ride

KCH390 \$1,947  
**SPECIAL MAP \$779<sup>95</sup>**

## A CUSTOM

SZ PART# MSRP MAP

### A Custom Box Set

5 CYMBAL SET-UP  
14" A Custom HiHats  
16" A Custom Crash  
18" A Custom Crash\*\*  
20" A Custom Medium Ride

A20579-11 \$1,992  
**SPECIAL MAP \$749<sup>95</sup>\***

## A ZILDJIAN

### A Zildjian A391 Box Set

5 CYMBAL SET-UP  
14" A New Beat HiHats  
16" A Medium Thin Crash  
18" A Medium Thin Crash\*\*  
21" A Sweet Ride

A391 \$1,870  
**SPECIAL MAP \$699<sup>95</sup>**

## ZHT

SZ PART# MSRP MAP

### ZHT 390

5 CYMBAL SET-UP  
14" ZHT Mastersound HiHats  
17" ZHT Fast Crash  
16" ZHT China\*\*  
20" ZHT Medium Ride

ZHT390 \$1015  
**SPECIAL MAP \$369<sup>95</sup>**

### ZHT Rock

4 CYMBAL SET-UP  
14" ZHT Rock HiHats  
16" ZHT Rock Crash  
20" ZHT Rock Ride

ZHTR4P \$796  
**SPECIAL MAP \$329<sup>95</sup>**

## ZBT

SZ PART# MSRP MAP

### ZBTP390-F

5 CYMBAL SET-UP  
14" ZBT HiHats  
16" ZBT Crash  
20" ZBT Ride  
14" ZBT Crash\*\*

ZBTP390-F \$655  
**SPECIAL MAP \$299<sup>95</sup>**

### ZBTS3P-9

4 CYMBAL SET-UP  
13" ZBT HiHats  
18" ZBT Crash Ride  
14" ZBT Crash\*\*

ZBTS3P-9 \$462  
**SPECIAL MAP \$199<sup>95</sup>\***

### ZBTE2P

2 CYMBAL SET-UP  
18" ZBT Crash  
18" ZBT China

ZBTE2P \$324  
**SPECIAL MAP \$139<sup>95</sup>**

# WELCOME TO THE FAMILIES

Begin with ZBT, the drummer's introduction to the Zildjian family of cymbals. Move up to the enhanced look and sound of ZHT. Then delve deep into the legacy A and K cymbal families to discover a wide spectrum of tonal qualities, from bright to dark.

# K

زیدجیان  
کونستانتینوپول  
K. ZILDJIAN  
CONSTANTINOPLE

The legendary K Constantinople is the pinnacle of the Zildjian cymbal line, renowned for its perfectly blended sound quality. Complex hammering contributes to the cymbal's unique sonic identity and dark tones that can be at once cutting and smooth. Drawing on cymbal-making techniques perfected in the Zildjian Sound Lab, K Constantinople cymbals can range from subtle to explosive.

*K Custom*

The modern voice of the K Family, K Custom cymbals are dark, rich, and dry. Designed with today's diverse music scene in mind, K Custom is both powerful and vibrant, yet dark and gentle.

# K

K Zildjian cymbals continue to inspire drummers today with their deep, warm, and expressive sounds developed by Keropé Zildjian in 19th Century Turkey. Elaborate hammering and lathing techniques work the Zildjian alloy into versatile cymbals that are dark yet well suited for a wide variety of musical genres from jazz to rock.





# A CUSTOM

Utilizes radical rotary hammering techniques, thin to medium weights, and a striking brilliant finish to produce a crisp, sweet, and bright sound. Great in any number of playing situations, these cymbals are ideal for contemporary music with their fast response and clean attack.

# A

Zildjian's classic sound is embodied by A Zildjian and immortalized in countless recordings by the greatest drummers of all time. Known for their versatility, these bright cymbals range from paper thin and delicate to extra heavy and cutting. The Zildjian Sound Lab recently made adjustments to the curvature and weights of its current models to capture the sweet spot of the classic A sound, producing crashes, rides, and hats that reflect today's musical styles.

# fx

**SPECIAL EFFECTS**  
Experiment with a variety of effects and accents with this unique, innovative line of cymbals from Zildjian. Add exotic colors and character to your sound with an Oriental China Trash or a Trashformer.



# zht zbt

ZHT, Zildjian's signature B12 alloy delivers a rich sounding cymbal that is bright, melodic, and designed for a wide range of musical styles.

ZBT, your introduction to the Zildjian family of cymbals. With innovative manufacturing techniques developed in the Zildjian Sound Lab, ZBT delivers a bright, intense sound that cuts through the mix. Also featuring extensive lathing with a traditional finish.







زید کسروپولیان  
K. ZILDJIAN  
CONSTANTINOPLE

**K**  
KEROPE™

*K Custom*

**K**

**K FAMILY**

Characterized by dark overtones, the Zildjian K legacy sound draws on the Company's centuries-old tradition of cymbal making, providing a rich spectrum of sound. Warm, expressive K's. Complex, modern K Customs. And legendary K Constantinoples, famous for their perfectly blended tones.

**DARK  
WARM**

زید کسروپولیان  
K. ZILDJIAN  
CONSTANTINOPLE

**Rides**

SZ PART# MSRP MAP

**Medium Thin Ride, High**



20 K1115 \$772 \$439<sup>95</sup>

22 K1121 \$911 \$519<sup>95</sup>

**Medium Thin Ride, Low**



20 K1113 \$772 \$439<sup>95</sup>

22 K1119 \$911 \$519<sup>95</sup>\*

**Medium Ride**



20 K1016 \$772 \$439<sup>95</sup>\*

22 K1020 \$911 \$519<sup>95</sup>

**Thin Ride  
Overhammered**



22 K1101 \$911 \$519<sup>95</sup>

**Bounce Ride**



20 K1060 \$772 \$439<sup>95</sup>

22 K1114 \$911 \$519<sup>95</sup>

**Renaissance Ride**



22 K1116 \$911 \$519<sup>95</sup>\*

**Crash Ride**



19 K1069 \$724 \$409<sup>95</sup>\*

**Crashes**

SZ PART# MSRP MAP

**Crash**



15 K1065 \$524 \$299<sup>95</sup>

16 K1066 \$561 \$319<sup>95</sup>\*

17 K1067 \$610 \$349<sup>95</sup>

18 K1068 \$667 \$379<sup>95</sup>\*

**HiHats**

SZ PART# MSRP MAP

**K Constantinoples**

**HiHats**



14 K1070 \$914 \$519<sup>95</sup>P\*

14 K1071 \$457 \$259<sup>95</sup>T

14 K1072 \$457 \$259<sup>95</sup>B





کونستانتنوپل  
K. ZILDJIAN  
CONSTANTINOPLES

**K**  
KEROPE™

*K Custom*

**K**

**K FAMILY**

Characterized by dark overtones, the Zildjian K legacy sound draws on the Company's centuries-old tradition of cymbal making, providing a rich spectrum of sound. Warm, expressive K's. Complex, modern K Customs. And legendary K Constantinoples, famous for their perfectly blended tones.

\*\* Added Value

**DARK  
WARM**



**Rides**

SZ	PART#	MSRP	MAP
<b>Custom Ride</b> [T] [MT]			
20	K20889	\$616	\$349 <sup>95</sup> *
<b>Custom Medium Ride</b> [T] [M]			
20	K0854	\$616	\$349 <sup>95</sup>
22	K0856	\$731	\$419 <sup>95</sup>
<b>Custom Dark Complex Ride</b> [S] [MT]			
21	K0963	\$671	\$379 <sup>95</sup> *
22	K0964	\$731	\$419 <sup>95</sup>
<b>Custom Dark Ride</b> [T] [MT]			
20	K0965	\$616	\$349 <sup>95</sup> *
22	K0967	\$731	\$419 <sup>95</sup> *
<b>Custom Dry Ride</b> [M]			
20	K0886	\$616	\$349 <sup>95</sup>
<b>Custom Hybrid Ride</b> [M]			
20	K0998	\$616	\$349 <sup>95</sup> *
21	K0999	\$671	\$379 <sup>95</sup>
<b>Custom Session Ride</b> [M]			
20	K0997	\$616	\$349 <sup>95</sup>
<b>Custom Dry Light Ride</b> [MT]			
20	K0966	\$616	\$349 <sup>95</sup>
<b>Custom Special Dry Ride</b> [MT]			
21	K0969	\$671	\$379 <sup>95</sup>
<b>Custom Left Side Ride, with 3 Rivets</b> [MT]			
20	K0986	\$616	\$349 <sup>95</sup>
<b>Custom High Definition Ride</b> [MT]			
22	K0989	\$731	\$419 <sup>95</sup>
<b>Custom Flat Top</b> [MT]			
20	K0882	\$616	\$349 <sup>95</sup>

The modern voice of the K Family, K Custom cymbals are dark, rich, and dry. Designed with today's diverse music scene in mind, K Custom is both powerful and vibrant, yet dark and gentle.

**Crashes**

SZ	PART#	MSRP	MAP
<b>Custom Dark Splash</b> [T] [PT]			
8	K0930	\$221	\$124 <sup>95</sup> *
10	K0932	\$250	\$144 <sup>95</sup> *
12	K0934	\$291	\$169 <sup>95</sup>
<b>Custom Hybrid Splash</b> [PT]			
9	K1209	\$235	\$134 <sup>95</sup> +
11	K1211	\$269	\$154 <sup>95</sup> *
<b>Custom Dark Crash</b> [T] [T]			
14	K0949	\$387	\$219 <sup>95</sup>
15	K0950	\$421	\$239 <sup>95</sup>
16	K0951	\$461	\$264 <sup>95</sup> *
17	K0952	\$502	\$289 <sup>95</sup> *
18	K0953	\$537	\$309 <sup>95</sup> *
<b>Custom Fast Crash</b> [B] [PT]			
14	K0980	\$387	\$219 <sup>95</sup>
16	K0982	\$461	\$264 <sup>95</sup> *
17	K0983	\$502	\$289 <sup>95</sup>
18	K0984	\$537	\$309 <sup>95</sup>
<b>Custom Session Crash</b> [T] [T]			
16	K0990	\$461	\$264 <sup>95</sup>
18	K0991	\$537	\$309 <sup>95</sup>
<b>Custom Hybrid Crash</b> [M] [T]			
16	K1216	\$461	\$264 <sup>95</sup> *
17	K1217	\$502	\$289 <sup>95</sup> *
18	K1218	\$537	\$309 <sup>95</sup> *
19	K1219	\$582	\$329 <sup>95</sup> *

**HiHats**

SZ	PART#	MSRP	MAP
<b>Custom Dark HiHats</b> [T] Top: [MT] Bot: [M]			
13	K0940	\$688	\$399 <sup>95</sup> P
13	K0941	\$344	\$199 <sup>95</sup> T
13	K0942	\$344	\$199 <sup>95</sup> B
<b>Custom Dark HiHats</b> [T] Top: [MT] Bot: [M]			
14	K0943	\$774	\$439 <sup>95</sup> P*
14	K0944	\$387	\$219 <sup>95</sup> T
14	K0945	\$387	\$219 <sup>95</sup> B
<b>Custom Session HiHats</b> [T] Top: [M] Bot: [MT]			
14	K0993	\$774	\$439 <sup>95</sup> P
14	K0994	\$387	\$219 <sup>95</sup> T
14	K0995	\$387	\$219 <sup>95</sup> B
<b>Custom Hybrid HiHats</b> [T] Top: [MT] Bot: [M]			
13 <sup>1/4</sup>	K1213	\$688	\$399 <sup>95</sup> P*
13 <sup>1/4</sup>	K1214	\$344	\$199 <sup>95</sup> T
13 <sup>1/4</sup>	K1215	\$344	\$199 <sup>95</sup> B
14 <sup>1/4</sup>	K1224	\$774	\$439 <sup>95</sup> P*
14 <sup>1/4</sup>	K1225	\$387	\$219 <sup>95</sup> T
14 <sup>1/4</sup>	K1226	\$387	\$219 <sup>95</sup> B

**Special Effects**

SZ	PART#	MSRP	MAP
<b>Custom Dark China</b> [T] [T]			
17	K0970	\$522	\$299 <sup>95</sup>
<b>Custom Hybrid China</b> [M] [T]			
17	K1221	\$522	\$299 <sup>95</sup>
19	K1220	\$595	\$339 <sup>95</sup>
<b>Custom Hybrid Trash Smash</b> [M] [T]			
19	K0954	\$595	\$339 <sup>95</sup> *

**Box Sets**

<b>K Custom Hybrid Box Set</b>			
4 CYMBAL SET-UP			
14 1/4" K Custom Hybrid HiHats			
17" K Custom Hybrid Crash**			
21" K Custom Hybrid Ride			
<b>KCH390 \$1947</b>			
<b>SPECIAL MAP \$779<sup>95</sup></b>			





K Zildjian cymbals continue to inspire drummers today with their deep, warm, and expressive sounds developed by Keropé Zildjian in 19th Century Turkey. Elaborate hammering and lathing techniques work the Zildjian alloy into versatile cymbals that are dark yet well suited for a wide variety of musical genres from jazz to rock.

## Rides

SZ PART# MSRP MAP

**Ride**  
T (M)

20 K0817 \$594 \$339<sup>95\*</sup>

22 K0819 \$710 \$409<sup>95</sup>

**Dark Medium Ride**  
T (M)

22 K0830 \$710 \$409<sup>95</sup>

**Heavy Ride**  
T (H)

20 K0846 \$594 \$339<sup>95</sup>

**Light Ride**  
T (T)

22 K0832 \$710 \$409<sup>95</sup>

24 K0834 \$844 \$479<sup>95</sup>

**Light Flat Ride**  
T (T)

20 K0818 \$594 \$339<sup>95</sup>

**Crash Ride**  
T (MT)

18 K0808 \$520 \$299<sup>95</sup>

20 K0810 \$594 \$339<sup>95</sup>

**Crash Ride**  
T (MT)

21 K20835 \$649 \$374<sup>95</sup>

Custom Medium Ride  
O O O O

20 A20518 \$250 \$299

20 A20518 \$250 \$299

Custom Medium Ride  
O O O O

20 A20518 \$250 \$299

20 A20518 \$250 \$299

## Crashes

SZ PART# MSRP MAP

**Splash**  
T (PT)

8 K0857 \$214 \$121<sup>95\*</sup>

10 K0858 \$240 \$134<sup>95\*</sup>

12 K0859 \$279 \$159<sup>95</sup>

**Dark Crash Thin**  
T (T)

15 K0901 \$398 \$229<sup>95</sup>

16 K0902 \$440 \$249<sup>95\*</sup>

17 K0903 \$483 \$279<sup>95</sup>

18 K0904 \$520 \$299<sup>95\*</sup>

19 K0905 \$560 \$319<sup>95\*</sup>

20 K0912 \$594 \$339<sup>95</sup>

**Dark Crash Medium Thin**  
T (MT)

16 K0913 \$440 \$249<sup>95\*</sup>

17 K0914 \$483 \$279<sup>95</sup>

18 K0915 \$520 \$299<sup>95</sup>

## HiHats

SZ PART# MSRP MAP

**HiHats**  
T (M) (MH)

13 K0820 \$648 \$369<sup>95P</sup>

13 K0821 \$324 \$184<sup>95T</sup>

13 K0822 \$324 \$184<sup>95B</sup>

14 K0823 \$728 \$419<sup>95P\*</sup>

14 K0824 \$364 \$209<sup>95T</sup>

14 K0825 \$364 \$209<sup>95B</sup>

**Mastersound HiHats**  
T (M) (MH)

14 K0909 \$728 \$419<sup>95P\*</sup>

14 K0910 \$364 \$209<sup>95T</sup>

14 K0911 \$364 \$209<sup>95B</sup>

**Light HiHats**  
T Top: (MT) Bot: (M)

14 K0812 \$728 \$419<sup>95P</sup>

14 K0813 \$364 \$209<sup>95T</sup>

14 K0814 \$364 \$209<sup>95B</sup>

15 K0923 \$796 \$459<sup>95P\*</sup>

15 K0924 \$398 \$229<sup>95T</sup>

15 K0925 \$398 \$229<sup>95B</sup>

16 K0926 \$880 \$499<sup>95P</sup>

16 K0927 \$440 \$249<sup>95T</sup>

16 K0928 \$440 \$249<sup>95B</sup>

**Special K/Z HiHats**  
Top: K Zildjian Top  
Bot: Dyno Beat

T Top: Bot:

13 K0829 \$580 \$329<sup>95P</sup>

14 K0839 \$655 \$379<sup>95P</sup>

## Special Effects

SZ PART# MSRP MAP

**Mini China**  
T (T)

14 K0881 \$383 \$219<sup>95</sup>

**China**  
T (T)

17 K0883 \$502 \$289<sup>95</sup>

19 K0885 \$579 \$329<sup>95</sup>

**EFX**  
T (T)

16 K0890 \$440 \$249<sup>95</sup>

18 K0888 \$520 \$299<sup>95</sup>

## Box Sets

**K Zildjian Box Set**

4 CYMBAL SET-UP

14" K HiHats

16" K Dark Thin Crash

18" K Dark Thin Crash\*\*

20" K Ride

K0800 \$2,282

SPECIAL MAP \$899<sup>95</sup>

**HIHAT KEY**  
P = PAIR      T = TOP      B = BOTTOM

**FINISH**  
T TRADITIONAL      N NATURAL  
B BRILLIANT      S SATIN  
BT BRILLIANT AND TRADITIONAL      BI BRILLIANT INNER, TRADITIONAL OUTER  
BTI BRILLIANT TOP AND TRADITIONAL BOTTOM

**WEIGHT**  
PT PAPER THIN      MT MEDIUM THIN      MH MEDIUM HEAVY      EH EXTRA HEAVY  
T THIN      M MEDIUM      H HEAVY

Best Sellers = \*

New/Re-released Models = orange box

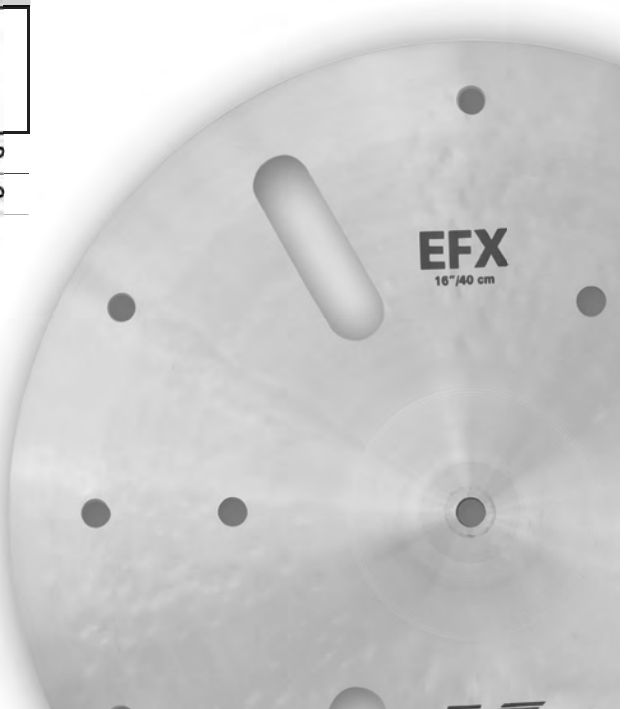

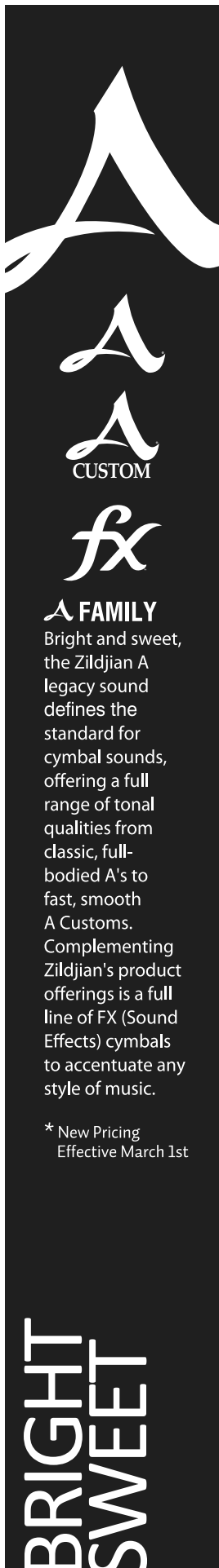

## Rides

SZ PART# MSRP MAP

**Medium Ride**  
T M

20 A0034 \$476 \$274<sup>95\*</sup>

22 A0036 \$569 \$329<sup>95</sup>

24 A0037 \$618 \$349<sup>95</sup>

**Rock Ride**  
T H

20 A0080 \$476 \$274<sup>95</sup>

21 A0081 \$521 \$299<sup>95</sup>

**Sweet Ride**  
T MT

21 A0079 \$521 \$299<sup>95\*</sup>

23 A0082 \$594 \$339<sup>95</sup>

**Sweet Ride**  
T MT

21 A20079 \$521 \$299<sup>95\*</sup>

**Crash Ride**  
T MT

18 A0022 \$415 \$239<sup>95</sup>

20 A0024 \$476 \$274<sup>95</sup>

**Armand Beautiful Baby Ride with 3 Rivets**  
T MT

19 A0044 \$591 \$344<sup>95</sup>

**Ping Ride**  
T MH

20 A0042 \$476 \$274<sup>95</sup>

**Medium-Heavy Ride**  
B MH

22 A0052 \$569 \$329<sup>95</sup>

**Mega Bell Ride**  
T EH

21 A0070 \$521 \$299<sup>95</sup>

**Thrash Ride**  
T MH

19 A0040 \$448 \$254<sup>95</sup>

Zildjian's classic sound is embodied by A Zildjian and immortalized in countless recordings by the greatest drummers of all time. Known for their versatility, these bright cymbals range from paper thin and delicate to extra heavy and cutting. The Zildjian Sound Lab recently made adjustments to the curvature and weights of its current models to capture the sweet spot of the classic A sound, producing crashes, rides, and hats that reflect today's musical styles.

## Crashes

SZ PART# MSRP MAP

**Splash**  
T PT

6 A0206 \$146 \$84<sup>95\*</sup>

8 A0210 \$171 \$99<sup>95\*</sup>

10 A0211 \$201 \$114<sup>95\*</sup>

12 A0212 \$232 \$134<sup>95</sup>

**Fast Crash**  
T PT

14 A0264 \$291 \$169<sup>95\*</sup>

15 A0265 \$318 \$184<sup>95</sup>

16 A0266 \$352 \$199<sup>95</sup>

17 A0267 \$387 \$219<sup>95</sup>

18 A0268 \$415 \$239<sup>95</sup>

**Thin Crash**  
T T

16 A0223 \$352 \$199<sup>95\*</sup>

17 A0224 \$387 \$219<sup>95</sup>

18 A0225 \$415 \$239<sup>95</sup>

19 A0226 \$448 \$254<sup>95</sup>

20 A0227 \$476 \$274<sup>95</sup>

**Medium Thin Crash**  
T MT

16 A0230 \$352 \$199<sup>95\*</sup>

17 A0231 \$387 \$219<sup>95\*</sup>

18 A0232 \$415 \$239<sup>95\*</sup>

19 A0233 \$448 \$254<sup>95</sup>

20 A0234 \$476 \$274<sup>95</sup>

**Medium Crash**  
T M

16 A0240 \$352 \$199<sup>95\*</sup>

18 A0242 \$415 \$239<sup>95\*</sup>

**Rock Crash**  
T MH

16 A0250 \$352 \$199<sup>95</sup>

18 A0252 \$415 \$239<sup>95</sup>

**Heavy Crash**  
B M

16 A0276 \$352 \$199<sup>95</sup>

17 A0277 \$387 \$219<sup>95</sup>

18 A0278 \$415 \$239<sup>95</sup>

19 A0279 \$448 \$254<sup>95</sup>

## HiHats

SZ PART# MSRP MAP

**New Beat HiHats**  
T Top: M Bot: H

13 A0130 \$514 \$299<sup>95P\*</sup>

13 A0131 \$257 \$149<sup>95T</sup>

13 A0132 \$257 \$149<sup>95B</sup>

14 A0133 \$582 \$339<sup>95P\*</sup>

14 A0134 \$291 \$169<sup>95T</sup>

14 A0135 \$291 \$169<sup>95B</sup>

15 A0136 \$636 \$369<sup>95P</sup>

15 A0137 \$318 \$184<sup>95T</sup>

15 A0138 \$318 \$184<sup>95B</sup>

**Mastersound HiHats**  
T Top: M Bot: H

13 A0120 \$514 \$299<sup>95P</sup>

13 A0121 \$257 \$149<sup>95T</sup>

13 A0122 \$257 \$149<sup>95B</sup>

14 A0123 \$582 \$339<sup>95P\*</sup>

14 A0124 \$291 \$169<sup>95T</sup>

14 A0125 \$291 \$169<sup>95B</sup>

**Rock HiHats**  
T Top: H Bot: EH

14 A0160 \$582 \$339<sup>95P</sup>

14 A0161 \$291 \$169<sup>95T</sup>

14 A0162 \$291 \$169<sup>95B</sup>

**Quick Beat HiHats**  
T Top: MH Bot: H

14 A0150 \$582 \$339<sup>95P</sup>

14 A0151 \$291 \$169<sup>95T</sup>

14 A0152 \$291 \$169<sup>95B</sup>

**Dyno Beat HiHats**  
B EH One Only

13 Z40131 \$257 \$149<sup>95</sup>

14 Z40134 \$291 \$169<sup>95</sup>

## HiHats (Cont.)

SZ PART# MSRP MAP

**Special Recording HiHats**  
T Top: M Bot: MH

12 A0103 \$464 \$269<sup>95P</sup>

12 A0104 \$232 \$134<sup>95T</sup>

12 A0105 \$232 \$134<sup>95B</sup>

**Pocket HiHats**  
T Top: T Bot: H

13 A0144 \$514 \$299<sup>95P</sup>

13 A0145 \$257 \$149<sup>95T</sup>

13 A0146 \$257 \$149<sup>95B</sup>

**Heavy HiHats**  
T Top: M Bot: H

15 A0156 \$636 \$369<sup>95P</sup>

15 A0157 \$318 \$184<sup>95T</sup>

15 A0158 \$318 \$184<sup>95B</sup>

## Special Effects

**China Low**  
T T

18 A0344 \$436 \$249<sup>95</sup>

**China High**  
T T

16 A0352 \$382 \$219<sup>95</sup>

18 A0354 \$436 \$249<sup>95</sup>

**Swish Knocker with 20 Rivets**  
T M

22 A0315 \$589 \$339<sup>95</sup>

**Ultra Hammered China**  
B T

19 A0369 \$467 \$264<sup>95</sup>

21 A0361 \$542 \$314<sup>95</sup>

## Box Sets

**A Zildjian A391 Box Set**

5 CYMBAL SET-UP

14" A New Beat HiHats

16" A Medium Thin Crash

18" A Medium Thin Crash\*\*

21" A Sweet Ride

A391 \$1,870

SPECIAL MAP \$699<sup>95</sup>

\* New Pricing  
Effective March 1st

BRIGHT  
SWEET



Utilizes radical rotary hammering techniques, thin to medium weights, and a striking brilliant finish to produce a crisp, sweet, and bright sound. Great in any number of playing situations, these cymbals are ideal for contemporary music with their fast response and clean attack.

## Rides

SZ PART# MSRP MAP

### Custom Ride



20 A20518 \$520 \$299<sup>95\*</sup>

22 A20520 \$621 \$354<sup>95\*</sup>

### Custom Medium Ride



20 A20519 \$520 \$299<sup>95\*</sup>

22 A20523 \$621 \$354<sup>95\*</sup>

### Custom Ping Ride



20 A20522 \$520 \$299<sup>95\*</sup>

22 A20524 \$621 \$354<sup>95\*</sup>

### Custom ReZo Ride



21 A20821 \$570 \$329<sup>95\*</sup>

### Custom Sizzle Ride with 6 Rivets



20 A20526 \$520 \$299<sup>95\*</sup>

### Custom Projection Ride



20 A20586 \$520 \$299<sup>95\*</sup>

### Custom 20th Anniversary Ride



21 A20822 \$570 \$329<sup>95\*</sup>

## Crashes

SZ PART# MSRP MAP

### Custom Splash



6 A20538 \$159 \$89<sup>95\*</sup>

8 A20540 \$185 \$104<sup>95\*</sup>

10 A20542 \$218 \$124<sup>95\*</sup>

12 A20544 \$255 \$144<sup>95\*</sup>

### Custom Crash



14 A20525 \$318 \$184<sup>95\*</sup>

15 A20513 \$350 \$199<sup>95\*</sup>

16 A20514 \$383 \$219<sup>95\*</sup>

17 A20515 \$422 \$239<sup>95\*</sup>

18 A20516 \$453 \$259<sup>95\*</sup>

19 A20517 \$489 \$284<sup>95\*</sup>

20 A20588 \$520 \$299<sup>95\*</sup>

### Custom Projection Crash



16 A20582 \$383 \$219<sup>95\*</sup>

17 A20583 \$422 \$239<sup>95\*</sup>

18 A20584 \$453 \$259<sup>95\*</sup>

19 A20585 \$489 \$284<sup>95\*</sup>

### Custom ReZo Crash



16 A20836 \$383 \$219<sup>95\*</sup>

17 A20837 \$422 \$239<sup>95\*</sup>

18 A20838 \$453 \$259<sup>95\*</sup>

19 A20839 \$489 \$284<sup>95\*</sup>

20 A20840 \$520 \$299<sup>95\*</sup>

### Custom Medium Crash



16 A20826 \$383 \$219<sup>95\*</sup>

17 A20827 \$422 \$239<sup>95\*</sup>

18 A20828 \$453 \$259<sup>95\*</sup>

19 A20829 \$489 \$284<sup>95\*</sup>

### Custom Fast Crash



14 A20536 \$318 \$184<sup>95\*</sup>

15 A20531 \$350 \$199<sup>95\*</sup>

16 A20532 \$383 \$219<sup>95\*</sup>

17 A20533 \$422 \$239<sup>95\*</sup>

18 A20534 \$453 \$259<sup>95\*</sup>

## HiHats

SZ PART# MSRP MAP

### Custom HiHats



13 A20507 \$572 \$329<sup>95\*</sup>P

13 A20508 \$286 \$164<sup>95\*</sup>T

13 A20509 \$286 \$164<sup>95\*</sup>B

14 A20510 \$636 \$369<sup>95\*</sup>P\*

14 A20511 \$318 \$184<sup>95\*</sup>T

14 A20512 \$318 \$184<sup>95\*</sup>B

### Custom Mastersound HiHats



13 A20500 \$572 \$329<sup>95\*</sup>P

13 A20501 \$286 \$164<sup>95\*</sup>T

13 A20502 \$286 \$164<sup>95\*</sup>B

14 A20550 \$636 \$369<sup>95\*</sup>P\*

14 A20551 \$318 \$184<sup>95\*</sup>T

14 A20552 \$318 \$184<sup>95\*</sup>B

15 A20553 \$700 \$399<sup>95\*</sup>P

15 A20554 \$350 \$199<sup>95\*</sup>T

15 A20555 \$350 \$199<sup>95\*</sup>B

### Custom ReZo HiHats



14 A20800 \$636 \$369<sup>95\*</sup>P

14 A20801 \$318 \$184<sup>95\*</sup>T

14 A20802 \$318 \$184<sup>95\*</sup>B

## Special Effects

SZ PART# MSRP MAP

### Custom China



18 A20529 \$470 \$274<sup>95\*</sup>\*

20 A20530 \$538 \$309<sup>95\*</sup>

### Custom EFX



10 A20808 \$218 \$124<sup>95\*</sup>

14 A20814 \$318 \$184<sup>95\*</sup>\*

16 A20816 \$383 \$219<sup>95\*</sup>\*

18 A20818 \$453 \$259<sup>95\*</sup>\*

20 A20820 \$520 \$299<sup>95\*</sup>

## Box Sets

### A Custom Box Set

5 CYMBAL SET-UP

14" A Custom HiHats

16" A Custom Crash

18" A Custom Crash\*\*

20" A Custom Medium Ride

A20579-11 \$1992

SPECIAL MAP \$749<sup>95\*</sup>

#### HIHAT KEY

P = PAIR

T = TOP

B = BOTTOM

#### FINISH

T TRADITIONAL

N NATURAL

B BRILLIANT

S SATIN

BT BRILLIANT AND TRADITIONAL

TB BRILLIANT INNER, TRADITIONAL OUTER

#### WEIGHT

PT PAPER THIN

MT MEDIUM THIN

MH MEDIUM HEAVY

EH EXTRA HEAVY

T THIN

M MEDIUM

H HEAVY

Best Sellers = \*

New/Re-released Models = *orange label*



**A FAMILY**  
Bright and sweet, the Zildjian A legacy sound defines the standard for cymbal sounds, offering a full range of tonal qualities from classic, full-bodied A's to fast, smooth A Customs. Complementing Zildjian's product offerings is a full line of FX (Sound Effects) cymbals to accentuate any style of music.

**BRIGHT SWEET**



**SPECIAL EFFECTS**

**Azuka**

SZ PART# MSRP MAP

Latin Multi-Crash  
Hand & Stick  
B PT

15 A20015 \$318 \$184<sup>95</sup>

El Sonido Multi  
Crash Ride  
B MT

17 A20017 \$387 \$219<sup>95</sup>

**SPECIAL EFFECTS**

Experiment with a variety of effects and accents with this unique, innovative line of cymbals from Zildjian. Add exotic colors and character to your sound with an Oriental China Trash or a Trashformer.

**Oriental**

SZ PART# MSRP MAP

China "Trash"  
B T

12 A0612 \$290 \$164<sup>95\*</sup>

13 A0613 \$300 \$174<sup>95</sup>

14 A0614 \$311 \$179<sup>95\*</sup>

15 A0615 \$345 \$199<sup>95</sup>

16 A0616 \$382 \$219<sup>95\*</sup>

18 A0618 \$436 \$249<sup>95\*</sup>

20 A0620 \$495 \$284<sup>95</sup>

Crash of Doom  
T T

20 A0621 \$495 \$284<sup>95</sup>

"Trash" Splash  
B PT

9 A0609 \$189 \$109<sup>95\*</sup>

11 A0611 \$218 \$124<sup>95</sup>

**Zil-Bels**

SZ PART# MSRP MAP

ZIL-BEL, Small  
B

6 A20001 \$195 \$109<sup>95\*</sup>

ZIL-BEL, Large  
B

9.5 A20002 \$257 \$144<sup>95\*</sup>

**Trashformer**

SZ PART# MSRP MAP

Trashformer  
T T

8 zxt8TRF \$99 \$54<sup>95\*</sup>

10 zxt10TRF \$113 \$64<sup>95\*</sup>

14 zxt14TRF \$139 \$79<sup>95\*</sup>

Spiral Trash  
T T

18 FXSPL18 \$352 \$199<sup>95</sup>

Dancer Zils,  
Set of Two Pairs

P0770 \$59<sup>95</sup>

Finger Cymbals,  
Thick, Pair

P0771 \$29<sup>95</sup>

Finger Cymbals,  
Thin, Pair

P0773 \$29<sup>95</sup>

Metal Castanets, Pair

P0775 \$49





### Z FAMILY

ZBT, your introduction to the Zildjian family of cymbals. With innovative manufacturing techniques developed in the Zildjian Sound Lab, ZBT delivers a bright, intense sound that cuts through the mix. Also featuring extensive lathing with a traditional finish.

ZHT, Zildjian's signature B12 alloy delivers a rich sounding cymbal that is bright, melodic, and designed for a wide range of musical styles.

\*\* Added Value



## Rides

SZ PART# MSRP MAP

### Medium Ride



20 ZHT20MR \$278 \$154<sup>95\*</sup>

### Rock Ride



20 ZHT20RR \$278 \$154<sup>95\*</sup>

### Ride



22 ZHT22R \$310 \$169<sup>95\*</sup>

### Crash Ride



18 ZHT18CR \$233 \$129<sup>95\*</sup>

## Crashes

SZ PART# MSRP MAP

### Splash



8 ZHT8S \$106 \$59<sup>95\*</sup>

10 ZHT10S \$127 \$69<sup>95\*</sup>

### China Splash



8 ZHT8CS \$106 \$59<sup>95\*</sup>

10 ZHT10CS \$127 \$69<sup>95\*</sup>

### Fast Crash



14 ZHT14FC \$156 \$84<sup>95\*</sup>

15 ZHT15FC \$180 \$99<sup>95\*</sup>

16 ZHT16FC \$206 \$114<sup>95\*</sup>

17 ZHT17FC \$219 \$119<sup>95\*</sup>

18 ZHT18FC \$233 \$129<sup>95\*</sup>

### Medium Thin Crash



16 ZHT16MTC \$206 \$114<sup>95\*</sup>

18 ZHT18MTC \$233 \$129<sup>95\*</sup>

### Rock Crash



16 ZHT16RC \$206 \$114<sup>95\*</sup>

18 ZHT18RC \$233 \$129<sup>95\*</sup>

## HiHats

SZ PART# MSRP MAP

### HiHats



14 ZHT14HPR \$312 \$169<sup>95\*</sup>P

14 ZHT14HT \$156 \$84<sup>95\*</sup>T

14 ZHT14HB \$156 \$84<sup>95\*</sup>B

### Mastersound HiHats



13 ZHT13MPR \$278 \$149<sup>95\*</sup>P

13 ZHT13MT \$139 \$74<sup>95\*</sup>T

13 ZHT13MB \$139 \$74<sup>95\*</sup>B

14 ZHT14MPR \$312 \$169<sup>95\*</sup>P\*

14 ZHT14MT \$156 \$84<sup>95\*</sup>T

14 ZHT14MB \$156 \$84<sup>95\*</sup>B

15 ZHT15MPR \$360 \$199<sup>95\*</sup>P

15 ZHT15MT \$180 \$99<sup>95\*</sup>T

15 ZHT15MB \$180 \$99<sup>95\*</sup>B

### Rock HiHats



14 ZHT14RPR \$312 \$169<sup>95\*</sup>P

14 ZHT14RT \$156 \$84<sup>95\*</sup>T

14 ZHT14RB \$156 \$84<sup>95\*</sup>B

### Mini-Hats



10 ZHT10HPR \$254 \$139<sup>95\*</sup>P

10 ZHT10HT \$127 \$69<sup>95\*</sup>T

10 ZHT10HB \$127 \$69<sup>95\*</sup>B

## Special Effects

SZ PART# MSRP MAP

### China



16 ZHT16CH \$206 \$114<sup>95\*</sup>

18 ZHT18CH \$233 \$129<sup>95\*</sup>

### EFX



16 ZHT16EFX \$206 \$114<sup>95\*</sup>

18 ZHT18EFX \$233 \$129<sup>95\*</sup>

## Box Sets

### ZHT 390

5 CYMBAL SET-UP  
14" ZHT Mastersound HiHats  
17" ZHT Fast Crash  
16" ZHT China\*\*  
20" ZHT Medium Ride

ZHT390 \$1015  
SPECIAL MAP \$369<sup>95\*</sup>

### ZHT Rock

4 CYMBAL SET-UP  
14" ZHT Rock HiHats  
16" ZHT Rock Crash  
20" ZHT Rock Ride

ZHTR4P \$796  
SPECIAL MAP \$329<sup>95\*</sup>

#### HIHAT KEY

P = PAIR

T = TOP

B = BOTTOM

#### FINISH

**T** TRADITIONAL

**B** BRILLIANT

**BT** BRILLIANT AND TRADITIONAL

**N** NATURAL

**S** SATIN

**TB** BRILLIANT INNER, TRADITIONAL OUTER

**BT** BRILLIANT TOP AND TRADITIONAL BOTTOM

#### WEIGHT

**PT** PAPER THIN

**MT** MEDIUM THIN

**MH** MEDIUM HEAVY

**EH** EXTRA HEAVY

**T** THIN

**M** MEDIUM

**H** HEAVY

Best Sellers = \*

New/Re-released Models = orange box



### Z FAMILY

ZBT, your introduction to the Zildjian family of cymbals. With innovative manufacturing techniques developed in the Zildjian Sound Lab, ZBT delivers a bright, intense sound that cuts through the mix. Also featuring extensive lathing with a traditional finish.

ZHT, Zildjian's signature B12 alloy delivers a rich sounding cymbal that is bright, melodic, and designed for a wide range of musical styles.

\*\* Added Value

\* New Pricing Effective March 1st



### Rides

SZ PART# MSRP MAP

#### Ride

T M

20 ZBT20R \$198 \$109<sup>95\*</sup>

22 ZBT22R \$235 \$129<sup>95</sup>

#### Crash Ride

T MT

18 ZBT18CR \$162 \$89<sup>95\*</sup>

20 ZBT20CR \$198 \$109<sup>95\*</sup>

### Crashes

SZ PART# MSRP MAP

#### Splash

T PT

10 ZBT10S \$88 \$49<sup>95\*</sup>

#### Crash

T MT

14 ZBT14C \$106 \$59<sup>95\*</sup>

16 ZBT16C \$139 \$74<sup>95\*</sup>

17 ZBT17C \$151 \$79<sup>95</sup>

18 ZBT18C \$162 \$89<sup>95\*</sup>

19 ZBT19C \$180 \$99<sup>95</sup>

### HiHats

SZ PART# MSRP MAP

#### HiHats

T Top: MT Bot: M

13 ZBT13HP \$194 \$109<sup>95P\*</sup>

13 ZBT13HT \$97 \$54<sup>95T</sup>

13 ZBT13HB \$97 \$54<sup>95B</sup>

14 ZBT14HP \$212 \$119<sup>95P\*</sup>

14 ZBT14HT \$106 \$59<sup>95T</sup>

14 ZBT14HB \$106 \$59<sup>95B</sup>

### Special Effects

SZ PART# MSRP MAP

#### China

T T

16 ZBT16CH \$139 \$74<sup>95\*</sup>

18 ZBT18CH \$162 \$89<sup>95\*</sup>

### Box Sets

#### ZBTS3P-9

4 CYMBAL SET-UP  
13" ZBT HiHats  
18" ZBT Crash Ride  
14" ZBT Crash\*\*

ZBTS3P-9 \$462  
**SPECIAL MAP \$199<sup>95\*</sup>**

#### ZBTP390-F

5 CYMBAL SET-UP  
14" ZBT HiHats  
16" ZBT Crash  
20" ZBT Ride  
14" ZBT Crash\*\*

ZBTP390-F \$655  
**SPECIAL MAP \$299<sup>95</sup>**

#### ZBTE2P

2 CYMBAL SET-UP  
18" ZBT Crash  
18" ZBT China

ZBTE2P \$324  
**SPECIAL MAP \$139<sup>95</sup>**



#### HIHAT KEY

P = PAIR

T = TOP

B = BOTTOM

#### FINISH

T TRADITIONAL

B BRILLIANT

BT BRILLIANT AND TRADITIONAL

N NATURAL

S SATIN

TB BRILLIANT INNER, TRADITIONAL OUTER

BT BRILLIANT TOP AND TRADITIONAL BOTTOM

#### WEIGHT

PT PAPER THIN

MT MEDIUM THIN

MH MEDIUM HEAVY

EH EXTRA HEAVY

T THIN

M MEDIUM

H HEAVY

Best Sellers = \*

New/Re-released Models = orange box



Zildjian has created the next generation of reduced volume cymbals, the Gen 16 Buffed Bronze Series. Using knowledge gained from the original Gen 16 nickel plated cymbal line, Zildjian craftsman drew upon the Company's rich design history to make subtle but important changes to the bell profiles of the original cymbals. Additional lathing has also been applied on the larger size models to increase the lower fundamental overtone structure. Also significant is the rich buffed bronze finish of the new line that greatly enhances its appearance and produces a warmer tone than the original Gen 16 nickel plated models.

\* Does not include pickup

\*\* Effective  
March 1st, 2014

\*\*\* Available  
Spring 2014

**Box Sets**  
(Buffed Bronze)\*\*\*

SZ PART# MSRP MAP

**368DS Buffed Bronze Box Set**

- 13" HiHats
- 16" Crash
- 18" Crash/Ride
- Digital Cymbal Processor
- 5 Channel Cable Snake
- Direct Source Pickups (3)

G16BS2DS **\$1199** \$899

**Box Sets**  
(Nickel Plated)

**368DS Nickel Box Set**

- 13" HiHats
- 16" Crash
- 18" Crash/Ride
- Digital Cymbal Processor
- 5 Channel Cable Snake
- Direct Source Pickups (3)

G16AES2DS **\$1299** \$799

**Singles\***  
(Buffed Bronze)\*\*\*

SZ PART# MSRP MAP

**12" Splash Cymbal**

G1612S **\$189** \$139

**16" Crash Cymbal**

G1616C **\$249** \$179

**16" China Cymbal**

G1616CH **\$249** \$179

**18" Crash Ride Cymbal**

G1618CR **\$319** \$239

**20" Ride Cymbal**

G1620R **\$349** \$259

**13" HiHat Cymbal**

G1613HP **\$348** \$259  
G1613HT **\$174** \$129  
G1613HB **\$174** \$129

**14" HiHat Cymbals**

G1614HP **\$448** \$329  
G1614HT **\$224** \$168  
G1614HB **\$224** \$168

**Singles\***  
(Nickel Plated)

**12" Splash Cymbal**

G16A12S **\$189** \$99

**14" Crash Cymbal**

G16A14C **\$224** \$119

**16" Crash Cymbal**

G16A16C **\$249** \$129

**16" China Cymbal**

G16A16CH **\$249** \$129

**18" Crash Ride Cymbal**

G16A18CR **\$319** \$169

**18" Crash Cymbal**

G16A18C **\$319** \$169

**20" Ride Cymbal**

G16A20R **\$349** \$179

**13" HiHat Cymbal**

G16A13HP **\$348** \$179  
G16A13HT **\$174** \$89  
G16A13HB **\$174** \$89

**14" HiHat Cymbals**

G16A14HP **\$448** \$229  
G16A14HT **\$174** \$119  
G16A14HB **\$174** \$119

**Cymbal Accessories**

SZ PART# MSRP MAP

**Cymbal 5 Channel Digital Cymbal Processor**

G16AE001 **\$575** \$399

**"Direct Source" Pickup**

G16AE002DS **\$119** \$89\*\*

**Dual Condenser Pickup**

G16AE002 **\$49** \$34

**5 Channel Cymbal Cable Snake**

G16AE003 **\$49** \$34

**Cymbal Cable - 6ft.**

G16AE004 **\$29** \$19

**Cymbal Extension Cable - 6ft.**

G16AE005 **\$29** \$19

**Cymbal Power Supply**

G16AE006 **\$49** \$34

**Cymbal Mount Kit**

G16AE007 **\$29** \$19

**Digital Cymbal Processor Mount**

G16AE008 **\$49** \$34

**Cymbal HiHat Clutch Kit**

G16AE009 **\$29** \$19

**HiHat Cable - 6ft.**

G16AE012 **\$29** \$19

**Cymbal Dampener Kit**

G16AE013 **\$4** \$3

**Cymbal Single Cable EST- 4ft.**

G16AE015 **\$19** \$14

**AE Rack & Accessories**

SZ PART# MSRP MAP

**AE Rack / Short**

G16AEDR1 **\$799** \$549

**AE Rack / Tall**

G16AEDR2 **\$849** \$599

**AE Rack Extension/ Short**

G16AEDR3 **\$279** \$199

**AE Rack Extension / Tall**

G16AEDR4 **\$299** \$219

**AE Rack Hinge-Clamp**

G16AEDR5 **\$139** \$99

**AE Rack Multi-Clamp**

G16AEDR6 **\$69** \$49

**AE Rack T-Clamp**

G16AEDR7 **\$59** \$44

**AE Rack Extension Clamp**

G16AEDR8 **\$59** \$44

**AE Rack Badge**

G16AEDRBADGE **\$19** \$14

# BAND & ORCHESTRAL

Designed in conjunction with world-class percussionists, Zildjian's Band and Orchestral cymbals are the ultimate in craftsmanship and sound. These cymbals are designed to meet the quality and consistency standards of the most demanding students, educators, and professional players.



## K Constantinople Orchestral

A dark, rich and expressive sound that blends and enhances any ensemble of musicians.

SZ PART# MSRP MAP

### K Constantinople\* Medium Light, Pairs



18 K1000 \$1334 \$759<sup>95\*</sup>

20 K1008 \$1544 \$879<sup>95</sup>

### K Constantinople\* Special Selection Medium Heavy, Pairs



17 K1032 \$1220 \$694<sup>95</sup>

18 K1002 \$1334 \$759<sup>95\*</sup>

20 K1010 \$1544 \$879<sup>95</sup>

### K Constantinople\* Vintage Orchestral Medium Light, Pairs



16 K1138 \$1122 \$639<sup>95</sup>

18 K1140 \$1334 \$759<sup>95\*</sup>

20 K1142 \$1544 \$879<sup>95</sup>

### K Constantinople\* Vintage Orchestral Medium Heavy, Pairs



16 K1136 \$1122 \$639<sup>95</sup>

18 K1122 \$1334 \$759<sup>95\*</sup>

20 K1144 \$1544 \$879<sup>95</sup>

SUSPENDED CYMBALS

### K Constantinople\* Suspended



16 K1022 \$561 \$319<sup>95</sup>

17 K1023 \$610 \$349<sup>95</sup>

18 K1012 \$667 \$379<sup>95\*</sup>

20 K1014 \$772 \$439<sup>95\*</sup>



## K Symphonic

Brighter than K Constantinople and darker than A Classic Orchestral. A core sound that will cut through any ensemble with a well balanced attack and sustain. Effortless playability and a consistent sound color throughout all dynamic levels. K Symphonic Light – a lighter weight than the K Symphonic.

SZ PART# MSRP MAP

### K Symphonic Light Traditional, Pairs



18 K2004 \$1156 \$659<sup>95</sup>

20 K2008 \$1332 \$769<sup>95</sup>

### K Symphonic Light Brilliant, Pairs



18 K2014 \$1156 \$659<sup>95</sup>

20 K2018 \$1332 \$769<sup>95</sup>

### K Symphonic, Pairs



17 K2102 \$1062 \$609<sup>95</sup>

18 K2104 \$1156 \$659<sup>95</sup>

19 K2106 \$1244 \$709<sup>95</sup>

20 K2108 \$1332 \$769<sup>95</sup>



## Classic Orchestral

A bright, natural and cutting sound that will project through any size ensemble. Perfect for the student or professional.

SZ PART# MSRP MAP

### Classic Orchestral Selection Medium Light, Pairs



16 A0751 \$832 \$479<sup>95\*</sup>

18 A0759 \$976 \$569<sup>95\*</sup>

20 A0767 \$1120 \$639<sup>95\*</sup>

22 A0771 \$1334 \$759<sup>95\*</sup>

### Classic Orchestral Selection Medium, Pairs



17 A0781 \$908 \$519<sup>95\*</sup>

19 A0783 \$1050 \$594<sup>95</sup>

### Classic Orchestral Selection Medium Heavy, Pairs



16 A0753 \$832 \$479<sup>95</sup>

18 A0761 \$976 \$569<sup>95</sup>

20 A0769 \$1120 \$639<sup>95</sup>

SUSPENDED CYMBALS

### Classic Orchestral Selection Suspended



14 A0412 \$343 \$199<sup>95</sup>

### Classic Orchestral Selection Suspended



16 A0417 \$416 \$239<sup>95</sup>

18 A0419 \$488 \$284<sup>95</sup>

20 A0421 \$560 \$319<sup>95</sup>



## Symphonic Tone

The traditional A Zildjian sound. Bright, full bodied and natural - in light (French), medium (Viennese) and heavy (German) weights.

SZ PART# MSRP MAP

### Symphonic French Tone, Pairs



18 A0427 \$832 \$479<sup>95</sup>

20 A0429 \$952 \$549<sup>95</sup>

### Symphonic Viennese Tone, Pairs



18 A0447 \$832 \$479<sup>95</sup>

20 A0449 \$952 \$549<sup>95\*</sup>

### Symphonic German Tone, Pairs



18 A0490 \$832 \$479<sup>95\*</sup>

20 A0492 \$952 \$549<sup>95</sup>



### Z-MAC

Zildjian's Multi Application Cymbal. Excellent for multiple uses in all school ensembles – jazz band, marching band and concert band.

SZ PART# MSRP MAP

#### Z-MAC, Pairs



14 A0471 \$582 \$339<sup>95\*</sup>

#### Z-MAC, Pairs



16 A0475 \$704 \$399<sup>95\*</sup>

18 A0477 \$832 \$479<sup>95\*</sup>

20 A0479 \$952 \$549<sup>95\*</sup>

### Concert Stage

A sound that blends and balances with all types of school ensembles

#### Concert Stage, Pairs



16 A0444 \$704 \$399<sup>95\*</sup>

18 A0454 \$832 \$479<sup>95\*</sup>

20 A0466 \$952 \$549<sup>95\*</sup>

### Stadium

Specially designed for contemporary drum corps and marching bands.

#### Stadium Medium, Pairs



14 A0452 \$582 \$339<sup>95\*</sup>

16 A0468 \$704 \$399<sup>95\*</sup>

18 A0483 \$832 \$479<sup>95\*</sup>

20 A0485 \$952 \$549<sup>95\*</sup>

#### Stadium Medium Heavy, Pairs



16 A0487 \$704 \$399<sup>95\*</sup>

18 A0495 \$832 \$479<sup>95\*</sup>

19 A0473 \$896 \$509<sup>95\*</sup>

20 A0497 \$952 \$549<sup>95\*</sup>



SZ PART# MSRP MAP

#### ZHT Band, Pairs



18 ZHT18BP \$466 \$249<sup>95\*</sup>



#### ZBT Band, Pairs



14 ZBT14BP \$212 \$119<sup>95\*</sup>

16 ZBT16BP \$278 \$149<sup>95\*</sup>

Marching, Drum Corps, Concert Band and K Symphonic cymbals do not include straps and pads. These can be found in the Gear & Accessories section.

Grommets are provided as standard on Stadium Series, Concert Stage Series, ZBT and ZHT Band Pairs and Z-MAC pairs. \*K Constantinople Orchestral cymbal pairs include: 20" Orchestral Cymbal Bag (P0726), one pair Orchestral Felt Pads (P0756) and one pair Leather Straps (P0750).

Grommets are not standard on orchestral cymbals. We do not recommend using them with these cymbals as they affect the purity of tone with orchestral cymbals.

Orchestral and Band cymbals are available separately. Ask for details when ordering.

### Gongs

The world's finest gongs, handmade in China.

SZ PART# MSRP MAP

#### 12" Traditional Gong T

P0512 \$99

#### 12" Table-top Gong Stand T

P0561 \$80

#### 12" Traditional Gong T and Table-top Stand Set

P0565 \$190

#### 20"x24" Gong Sheet T

P0503 \$375

\* Can be used on any boom stand.

### Orchestral Gongs

#### 26" Traditional Gong T

P0499 \$799\*

#### 30" Traditional Gong T

P0500 \$999\*

#### 34" Traditional Gong T

P0501 \$1450\*

#### 40" Traditional Gong T

P0502 \$2299\*

#### Gong Stand\* T

P0560 \$287\*

\*Holds all gongs through 40". 45" wide by 58" overall height. Black matte finish, square tube steel, on four casters.

#### Gong Mallet

0550 \$49 ea.

### Professional Crotales

Premium Grade Orchestral Crotales tuned to A-442. These instruments are cast from our Zildjian 80/20 Alloy

SZ PART# MSRP MAP

#### High Octave (13 Notes) w/Bar

P0665 \$3995 Set

#### High Octave—Single Note Specify Note (example:P0662A#)

P0662 \$308

#### Low Octave (13 Notes) w/Bar

P0675 \$3995 Set

#### Low Octave—Single Note Specify Note (example:P0672A#)

P0672 \$308

#### Ultra Low A Note

P0682A-UL \$470

#### Ultra Low B Note

P0682B-UL \$470

#### Two Octave High/Low (25 Notes) w/ 2 B

P0685 \$7675 Set

### Crotales

Standard Grade Orchestral Crotales tuned to A-440.

SZ PART# MSRP MAP

#### High Octave (13 Notes) w/o Bar

P0615 \$1995 Set\*

#### High Octave—Single Note Specify Note (example:P0612A#)

P0612 \$154

#### Low Octave (13 Notes) w/o Bar

P0625 \$1995 Set\*

#### Low Octave—Single Note Specify Note (example:P0622A#)

P0622 \$154

### Crotales Accessories

#### High Octave Deluxe Crotale Bar

P0637 \$279

#### Low Octave Deluxe Crotale Bar

P0636 \$279

#### Single Crotale Holder

P0633 \$39.95

#### Deluxe Crotale Carrying Bag, Durable Canvas (Hold one octave)

P0638 \$329

## CYMBAL PADS & STRAPS

2200D	White Pads & Straps.....	\$23.60 pr.
2220D	White, Fleece, Pads.....	16.20 pr.
2209D	White Fleece Straps.....	19.55 pr.
2230D	White Straps.....	19.75 pr.
2210D	Black, Fleece, Straps.....	19.75 pr.
UPCP	Leather Pads.....	62.00 pr.
UPCST	Leather Straps.....	22.00 pr.
0750	Leather straps (Zildjian).....	16.00 pr.
0751	Leather pads (Zildjian).....	26.95 pr.
0753	Wool pads (Zildjian).....	34.95 pr.
0756	Orch. Felt Pads.....	14.95 pr.
0760	Russet Leather Cymbal Handles.....	24.95 pr.
0761	Russet Leather Cymbal Pads.....	34.95 pr.
0762	Philharmonic Straps.....	69.95 pr.
3193	Lambs wool pads.....	28.50 pr.
3194	Lambs wool straps.....	28.50 pr.
3192	Leather straps.....	19.50 pr.
3176	Wood handle holders.....	32.55 pr.
3195	Pads & straps, white leather.....	42.00 pr.
LL1392	Ludwig Sling Shot.....	26.00B/pr.
LL1365	Ludwig Soft Holder.....	51.00B pr.
LL1366	Ludwig Thong.....	18.00B pr.
B3332	White Pads & Straps.....	30.15 pr.
3487	Black straps only.....	22.00 pr.
ADCA1	Pads.....	36.00 pr.



## EXTRAS

SIZE	PART#	MSRP
<b>Bandana</b>		
	T4609	\$9.95
<b>Cymbal Clock</b>		
	M2999	\$69.95
<b>Dog Tags</b>		
	T3904	\$24.95
<b>Dog Tag Key Ring</b>		
	T3907	\$11.95
<b>Koozie</b>		
	T3235	\$3.95
<b>Lanyard 1623</b>		
	T3230	\$9.95
<b>Leather Key Fob</b>		
	T3901	\$4.95
<b>Mouse Pad</b>		
	T3906	\$12.95*
<b>Pillowcase</b>		
	T3239	\$19.95
<b>Retro Wristbands</b>		
	T6900	\$10.95
<b>Ride Bumper Sticker</b>		
	ZM002	\$4.95
<b>Silicone Wristband</b>		
	T4543	\$3.00
<b>Time Tested Bar Stool</b>		
24"	T3402	\$69.95
30"	T3403	\$79.95
<b>Weekender Bag</b>		
	T3265	\$19.95*
<b>Zildjian Phone Case</b>		
iPhone 4/4S	T4405	\$9.95
iPhone 5	T4406	\$9.95
Galaxy S4	T4407	\$9.95
<b>Zildjian Pint Glass</b>		
	T5016	\$9.95*
<b>Zildjian Shot Glass</b>		
	T4606	\$8.95
<b>Zildjian Stainless Steel Water Bottle</b>		
	T6330	\$18.95

## SURVIVAL GEAR

SIZE	PART#	MSRP
<b>Cymbal Cleaning Polish</b>		
	P1300	\$14.95*
<b>Drumstick Wax</b>		
	TWAX	\$8.95*
<b>Super Drummer's Towel</b>		
	T3401	\$14.95
<b>Drummer's Gloves</b>		
S	P0821	\$29.95*
M	P0822	\$29.95*
L	P0823	\$29.95*
XL	P0824	\$29.95*
<b>Z-Key Tuning Key</b>		
	T3240	\$9.95*
<b>Survival Kit</b>		
	P0800	\$19.95**

## ACCESSORIES

SIZE	PART#	MSRP
<b>Clutch Felts, Package of 10</b>		
	P0918	\$5.95
<b>Cymbal Felts, Package of 10</b>		
	P0900	\$12.95*
<b>Cymbal Sleeves, Package of 24</b>		
	P0912	\$8.95
<b>HiHat Felts, Package of 10</b>		
	P0906	\$8.95*
<b>Joey Kramer Practice Pad</b>		
6"	P1206	\$36.95
<b>Lamb's Wool Pads, Pair</b>		
	P0753	\$34.95
<b>Leather Pads, Pair</b>		
	P0751	\$26.95*
<b>Leather Straps, Pair</b>		
	P0750	\$16*
<b>Orchestral Felt Pads, Pair</b>		
	P0756	\$14.95
<b>Philharmonic Straps, Pair</b>		
	P0762	\$69.95
<b>Russet Leather Cymbal Handles, Pair</b>		
	P0760	\$24.95
<b>Russet Leather Cymbal Pads, Pair</b>		
	P0761	\$34.95
<b>Sizzle Rivets, Package of 100</b>		
	P0790	\$6.95*
<b>Splash Cymbal Holder</b>		
	P0710	\$39.95
<b>Travis Barker Practice Pad</b>		
6"	P1204	\$36.95
<b>Tré Cool Practice Pad</b>		
6"	TREDP1	\$36.95
<b>Zildjian Practice Pad</b>		
6"	P1201	\$32.95*
12"	P1202	\$52.95*

# GEAR & ACCESSORIES

## ACCESSORIES

SIZE	PART#	MSRP
<b>Zildjian Hand Cymbal Cradle</b>		
	TCC	\$149
<b>Zildjian Suspended Cymbal Arm</b>		
	TCA	\$109

## CARRYING CASES

CYMBAL
<b>24" Super Cymbal Bag</b>
P0738 \$99.95
<b>22" Deluxe Cymbal Bag</b>
P0733 \$69.95*
<b>22" Zildjian Gig Cymbal Bag</b>
TGIG \$74.95*
<b>21" Cymbal Safe™ Case</b>
P1700 \$125*
<b>22" Session Cymbal Bag (Synthetic Leather)</b>
PSCB \$99.95*
<b>20" Cymbal Bag</b>
P0729 \$42.95*
<b>20" Orchestral Cymbal Bag K Constantinople Logo (Maroon)</b>
P0726 \$89.95
<b>22" Deluxe Cymbal Rollerbag</b>
P0650 \$199
DRUMSTICK
<b>Super Drumstick Bag</b>
T3256 \$34.95*
<b>Drumstick Bag</b>
T3255 \$19.95*
<b>Session Drumstick Bag (Synthetic Leather)</b>
PSSB \$59.95*
ARTIST COLLECTION BAGS
<b>Travis Barker Boom Box Cymbal Bag</b>
TRAVCB2 \$119.95*
<b>Travis Barker Boom Box Drumstick Bag</b>
TRAV2 \$44.95*
<b>Tré Cool Cymbal Bag</b>
TRECB2 \$119.95*
<b>Tré Cool Drumstick Bag</b>
TRESB2 \$44.95*

## CYMBAL SPRING



### AQUARIAN

The cymbal spring is a flexible cymbal holder that allows the cymbal to move naturally.

**A167** Medium (Red) .....\$19.30  
**A238** Heavy (Yellow) .....21.60

## CYMBAL SIZZLER



Converts any size or make cymbal into a sizzle cymbal. Made of aluminum for light weight.

**UPSIZ** .....\$40.00  
**Zildjian Rivets**  
**0790** Pack of 100.....6.95

## FINGER CYMBALS



**LP436** Latin Perc, Pair .....\$43.00  
**F800** Set 2 Pair .....18.60  
**0771** Zildjian, Pair (thick) .....29.95  
**0773** Zildjian, Pair (thin) .....29.95  
**0770** Dancer Zils, 2 Pair .....59.95  
**FC02** Bronze Pair .....34.00

## CYMBAL TOPS



Nylon, Threaded Cymbal Tops. Replaces wing nut.

**UPNTT** 12 pack, 6 mm .....\$24.00  
**UPNTT6** 6 pack, 6 mm .....17.00  
**UPEZ** Quick release.....20.00  
**VATSNB** Slick Nut .....16.99  
**8MMUPNTT** 12 pk, 8 mm .....28.00  
**8MMUPNTT6** 6 pk, 8 mm .....18.75

## RATTLER



Creates an exciting sizzle effect when placed on any cymbal. Fits up to 22" cymbal.

**S22** Small Beads .....\$19.75  
**R22L** Large Beads .....19.75

## CAC CYMBALS



**4112** 12" .....\$29.95  
**4114** 14" .....47.25  
**4116** 16" .....53.80

## DUNLOP



**6434** Cymbal Polish.....\$7.36  
**6422** Cymbal Cleaner-Polish.....7.17  
**6444** Shell & Hardware Clean.....7.36  
**6592** Orchestral Cleaner-Polish .....4.95  
**DUN5420** Cleaner/Mitten.....7.55

## LIZARD SPIT CYMBAL POLISH



Application and removal is easy, has barrier protectant for long lasting shine.

**LSCP** 4 oz. ....\$13.60

## CYMBAL CLEANER



Cleans and polishes cymbals. Wipe it on, wipe it off.

**BUCK** Buckaroo .....\$13.50

## TRICK



Drum Cymbal and Hardware cleaner.

**TP1** .....\$5.75  
**TP2** Cymbal & metal polish.  
**TP3** .....9.00

## GROOVE JUICE



Cymbal Cleaner  
**GICC** .....\$138.80/12  
**GICC6** .....69.40/6  
 Shell Shine  
**GJSS** .....6.95

## ZILDJIAN POLISH



Cleans and polishes cymbals. Removes sound deadening dirt.

**Z1300** Liquid, 8 oz. ....\$14.95

## BLITZ CYMBAL CARE



Non-toxic liquid cymbal cleaner and polish.

**BL336** 4 oz. ....\$4.20  
**CARE CLOTHS**  
**BL312** Blitz Cymbal Cleaner.....\$3.90

## FLITZ METAL POLISH



Non abrasive polish that will clean and polish virtually any metal.

**BP03511** .....\$13.20B

**FAX & E-MAIL ORDERS FOR PRINTED MUSIC WILL GET AN EXTRA 5% DISCOUNT**

**FAX: (708) 496-2130 or (888) 983-5537 • E-MAIL: sales@harristeller.com**

**WE STOCK INSTRUCTIONAL METHOD BOOKS AND DVD'S FOR THE PERCUSSIONIST**

## CYMBAL BAGS



**B4685** 22" Cordura, Nylon.....\$45.25  
**B4785** 22" w/compartments .....68.00

**ZILDJIAN**  
**0729** Economy, 20".....\$42.95  
**0733** Nylon.....69.95  
**0738** 24" w/divider .....99.95  
**0650** Rollerback.....199.00  
**PSCB** Synthetic Leather, 22".....99.95  
**TGIG** Z 22".....74.95

**ZILDJIAN ARTIST**  
**TRAVCB2** Travis Barker .....\$119.95  
**TRECB2** Tre Cool .....119.95

### CYMBAL BAG



Constructed of Ballistic Nylon, the SKB cymbal bag includes heavy duty dual zippers and fully lined interiors with individual internal dividers. An ergonomic handle with double stitched straps for maximum durability, the SKB-CB22 cymbal gig bag will hold up to 22" cymbals.

**SKBCB22** .....\$130.99

### CYMBAL SAFE



**1700** Zildjian.....\$125.00

### ON/STAGE



It holds a total of 8 cymbals (5 inside pocket, 3 outside pocket), the largest up to 22" in diameter. Interior foam dividers separate your cymbals and provide extra protection and support.

**CBT4200D** Deluxe Cymbal Bag with Trolley ....\$140.99 ea.

### CYMBAL CASES



Road tested and road worthy this case will hold 12 cymbals up to 22" in diameter.

**SKBCV8** .....\$205.99  
**SKBCS22** Safe .....261.99  
**SKBCV24W** 24" w/wheels.....242.99

## MIC EZE

**MIC1** Incorporates unique right-angle support arm design, horizontal mount, male threads.

**MIC1** .....\$29.25  
**TRIPLETS** 3 Pack MIC1 .....68.25B  
**MIE5** MIC1 w/5" Extension .....35.25B



**MIC1**

**MIC2** Utilizes female threads designed to be used with any MIC-EZE when a variety of angles are needed.

**MIC2**.....\$29.25

**MIC3** Comes with male threads and offers 180° of lateral movement, horizontal mount, male threads.

**MIC3**.....\$29.25

**MIC4** Slip-proof quick release Mic holder compatible with standard Mic stands.

**MIC4**.....\$29.25



**MIC2**

A combination system designed for tight miking patterns. Hinged swing style center.

**MIN EZE** .....\$47.25B  
**MAX EZE** Extended version of Min-Eze.....47.25B  
**FLEX 3** Dual clamp with 3" flexible center ....47.25B  
**FLEX 5** Dual clamp with 5" flexible center ....47.25B

## CYMBAL STACKER



Pack of 12 foam Stackers, 3 large and 9 small, to display drums.

**DS39BK** .....\$30.25 pk.

**STD1** Standard, 12" .....18.00

**MET1** Metric, 6mm .....23.00

**PDAX904** 4" .....18.99

**DW906** 6" .....33.99B

**DW909** Angle Adjustable ....83.99B

**SCMCSA6** 6" Gibraltar, screws onto 8mm cymbal tilter ....15.30

## CYMBAL HOLDER



Enables placement of extra cymbal on any stand.

**DAN309** W/tilter .....\$55.50

**UPCYH**.....41.50

## LP CLAWS



**LP592A** Mike .....\$51.00

**LP592** Claw only .....41.00

**LP592B** Percussion .....51.00

**LP592S** Splash.....51.00

## MOUNT ALL



**LP236A** Cymbal Mount.....\$56.00

## LUDWIG HARDWARE



<b>MODULAR 900 SERIES DOUBLE BRACE</b>	
LLM926CS	Modular Double Brace Cymbal Stand .....142.00B
LLM916HH	Modular Double Brace Hi-Hat Stand .....203.00

### CONCERT SNARE DRUM STANDS

LLC623SSC	Classic Single Brace Concert Snare Stand with Extension .....\$170.10
LLM923SSC	Modular Double Brace Concert Snare Stand with Extension .....224.70
LLM1394CXT	Modular Snare Stand Extension (1") .....47.25

### ROCKER II

LLT121SS	Snare Stand .....\$84.00
LLC1308SP	Classic Heavy Duty Spurs .....94.00B
LLR2973SP	Rocker Spurs.....95.60B

### TOM-TOM STAND

LLC342TSR	Classic/Rocker Mount .....\$176.00B
-----------	-------------------------------------

[www.ludwig-drums.com](http://www.ludwig-drums.com)

## HAMILTON HARDWARE



KB245

### CYMBAL STANDS

Engineered to fit close to your drums! Unique 'U' channel legs and braces developed for strength and light weight. Tubes dampened to prohibit rattles.

KB225	Folds to 24" .....\$65.00
KB245	Folds to 32" .....85.00

### SNARE STANDS

Innovative snare basket holds drum securely without excessive pressure or changing sound. Folds flat for easy transport. Holds a range of drum sizes with no change in height.

KB274	17½"-27" .....\$99.00
KB275	21½"-35" .....99.00

## DRUMMERS HARDWARE

### CONCERT SNARE STANDS



GIBRALTER, XTRA HEIGHT	
5706EX	.....\$99.00
SS856T	Cannon .....112.00

### CONCERT CYMBAL STANDS



4360	.....\$109.50
7614	.....112.50
TCC	Cradle Only, Zildjian.....149.00

## UNIVERSAL PERCUSSION



<b>CYMBAL STANDS</b>	
UP1220SCS	Single Brace .....\$39.00
UP1220DCS	Double Brace .....44.00
BS19K	With Boom .....69.00



<b>HI HAT STANDS</b>	
UP1220SHS	Single Brace .....\$61.00
UP1220DHS	Double Brace .....72.00



<b>DRUM PEDAL</b>	
UP1220DP	Double Spring ....\$47.00



<b>SNARE STANDS</b>	
UP1220SSS	Single Brace .....\$42.00
UP1220DSS	Double Brace .....45.00

[www.universalpercussion.com](http://www.universalpercussion.com)

## TRICK PERCUSSION



PRO1V1	Single Bass Drum Pedal.....\$549.00B
PRO1V2	Double Bass Drum Pedal .....1349.00B
PRO1V4	Pedal Beater .....49.95*



# DIXON STANDS



## SNARE STANDS



PSS-9290 PSS-9280 PSS-9270 PSS-9260

### SNARE STANDS

PSS-9290 (DIX906)	Heavy Double-Braced.....	\$92.41
PSS-9280 (DIX806)	Medium Double-Braced.....	\$75.61
PSS-9280EX (DIX806EX)	Extended, Medium Double-Braced	\$83.33
PSS-9270 (DIX706)	Light Double-Braced.....	\$65.79
PSS-9270EX (DIX706EX)	Extended, Light Double-Braced.....	\$72.81
PSS-9260 (DIX606)	Standard Single-Braced.....	\$52.46
PSS-9260EX (DIX606EX)	Extended, Standard Single-Braced	\$53.16



## BOOM CYMBAL STANDS

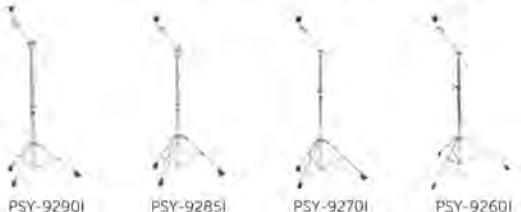

PSY-9290I PSY-9285I PSY-9270I PSY-9260I

### BOOM CYMBAL STANDS

PSY-9290I (DIX909)	Heavy Double-Braced.....	\$123.67
PSY-9285I (DIX809)	Medium Double-Braced 3-Stage.....	\$90.00
PSY-9270I (DIX709)	Light Double-Braced.....	\$70.51
PSY-9260I (DIX609)	Standard Single-Braced.....	\$66.61



## STRAIGHT CYMBAL STANDS



PSY-9290 PSY-9280 PSY-9270 PSY-9260

### STRAIGHT CYMBAL STANDS

PSY-9290 (DIX910)	Heavy Double-Braced .....	\$96.27
PSY-9280 (DIX810)	Medium Double-Braced.....	\$75.61
PSY-9270 (DIX710)	Light Double-Braced.....	\$56.32
PSY-9260 (DIX610)	Standard Single-Braced.....	\$47.36
PSY-9260SP (DIX610SP)	Economy Single-Braced.....	\$27.87



## HI-HAT STANDS



PSH-9290 PSH-9280 PSH-9270 PSH-9260

### HI-HAT STANDS

PSH-9290 (DIX907)	Heavy Double-Braced.....	\$128.93
PSH-9280 (DIX807)	Medium Double-Braced.....	\$104.38
PSH-9270 (DIX707)	Light Double-Braced.....	\$87.19
PSH-9260 (DIX607)	Standard Single-Braced.....	\$84.54



# DIXON PEDALS AND THRONES



## DIXON SINGLE PEDALS



PP-9290 PP-9280 PP-9270 PP-9260

### SINGLE PEDALS

PP-9290 (DIX911)	Pro Sprocket Drive Single .....	\$117.36
PP-9280 (DIX811)	Sprocket Drive Single .....	\$93.85
PP-9270 (DIX711)	Cam Drive Single.....	\$87.54
PP-9260 (DIX611)	Standard Single.....	\$65.79
PP9290CP	Cajon Pedal .....	\$171.60

### THRONES

PSN-9290 (DIX908)	Heavy Double-Braced.....	\$135.25
PSN-9280 (DIX808)	Medium Double-Braced.....	\$102.10
PSN-9270 (DIX708)	Light Double-Braced.....	\$83.14
PSN-9260T (DIX608T)	Standard Single-Braced.....	\$47.36



## DIXON DOUBLE PEDALS



PP-9290D PP-9280D PP-9270D

### DOUBLE PEDALS

PP-9290D (DIX911DB)	Pro Sprocket Drive Double.....	\$278.72
PP-9280D (DIX811DB)	Sprocket Drive Double.....	\$238.18
PP-9270D (DIX711DB)	Cam Drive Double.....	\$206.81



## DIXON THRONES



PSN-9290 PSN-9280 PSN-9270 PSN-9260T



## DRUMMERS THRONES



**DIXON**  
Fully padded vinyl seat. Adjustable height. Good student model.  
**PSN9260T (DIX608T) .....\$47.35**



**DIXON**  
Heavy duty throne double braced legs.  
**PSN9270 (DIX708) .....\$83.14**



**DIXON**  
**PSN9280 (DIX808) .....\$102.10**



**DIXON**  
Cast Collar Spindle  
**PSN9290 (DIX908) .....\$135.25**

### ULTRA



Backrest Throne – the adjustable backrest is a welcome addition during extended playing sessions. Throne seat adjusts to 30" high for stage use. Sturdy support is provided from four elliptical tube legs.  
**KT708 .....\$235.45B**

### CANON



Heavy duty, Double Braced  
**UP197 .....\$58.95**

### ON/STAGE



**DOUBLE-BRACED DRUM THRONE**  
Features a soft, round foam-cushioned seat, height-adjustable shaft and a spider-shaped insert at its base.  
**MDT2 .....\$81.99**

### QUIK LOK



Height adjustable musicians stool with adjustable footrest and back rest.  
**AMSDX749 .....\$199.99**

## PACIFIC THRONES



**PDDT700**  
Standard  
Throne  
**\$90.99**



**PDDT800**  
Standard  
Throne  
**\$145.99**



**PDDT820X**  
Tractor-Style  
Throne  
**\$163.99**



**PDDTC00**  
Concept Series  
Drum Throne  
**\$181.99**

# DRUM WORKSHOP PEDALS



<b>DW9000</b>	Infinite Cam Adjustment, Single Pedal .....	<b>\$516.99B</b>
<b>DW9002</b>	Infinite Cam Adjustment, Double Pedal.....	<b>999.99B</b>
<b>DW5000AD4</b>	Delta4 Accelerator Single Pedal .....	<b>333.99B</b>
<b>DW5000TD4</b>	Delta4 Turbo Single Pedal.....	<b>333.99B</b>
<b>DW5002AD4</b>	Delta4 Accelerator Double Pedal .....	<b>716.99B</b>
<b>DW5002TD4</b>	Delta4 Turbo Double Pedal.....	<b>716.99B</b>
<b>DW5002TDL3</b>	Delta4 Turbo Double Pedal (Lefty) .....	<b>665.99B</b>
<b>DW5002R</b>	Remote Double Pedal .....	<b>609.99B</b>
<b>DW5002RL</b>	Remote Double Pedal (Lefty) .....	<b>665.99B</b>

<b>DWMDD</b>	Machined Direct Drive Pedal.....	<b>\$799.99B</b>
<b>DWMDD2</b>	Machined Direct Drive Double Pedal.....	<b>1666.99</b>
<b>DW6000N</b>	Nylon Strap Single Pedal.....	<b>241.99B</b>
<b>DW6000AX</b>	Accelerator Single Pedal.....	<b>241.99B</b>
<b>DW6000CX</b>	Original Turbo Single Pedal.....	<b>241.99B</b>
<b>DW3000</b>	Double Chain Turbo Single Pedal.....	<b>208.99B</b>
<b>DW3002</b>	Double Chain Turbo Double Pedal .....	<b>366.99B</b>

# DRUM WORKSHOP FACTORY ACCESSORIES



<b>DWPADMJ</b>	Ghost Note Pro Practice Pad .....	<b>\$66.99B</b>
<b>DW798</b>	DogBone® Arm Adapter .....	<b>79.99B</b>
<b>DW799</b>	DWSM798 with Straight/Boom Cymbal Arm.....	<b>131.99B</b>
<b>DW778</b>	Mine DogBone® with Straight/Boom Cymbal Arm.....	<b>99.99B</b>
<b>DW991</b>	Single Tom Clamp .....	<b>69.99B</b>
<b>DW9212</b>	C-Hat Boom Arm.....	<b>108.99B</b>
<b>PDAX912</b>	1/2" x 18" Long Cymbal Boom Arm w/Tilter.....	<b>45.99</b>
<b>DW912S</b>	1/2" x 9" Boom Arm .....	<b>54.99B</b>
<b>DW934S</b>	3/4" x 9" Tube w/DW912 Cymbal Boom Arm.....	<b>99.99B</b>
<b>PDAX904</b>	4" Cymbal Stacker .....	<b>18.99B</b>
<b>DW906</b>	6" Cymbal Stacker .....	<b>33.99B</b>
<b>DWBDP</b>	Bass Drum Pillow, 14", 16" or 18".....	<b>49.75B</b>
<b>DW1207</b>	Delta Ball-Bearing Hinge.....	<b>68.99B</b>
<b>DW50P</b>	Delta Bass Drum Pedal Plate.....	<b>43.99B</b>
<b>DW909</b>	Angle Adjustable Cymbal Stacker.....	<b>83.99B</b>

<b>DW505</b>	Drop-Lock Hi-Hat Clutch.....	<b>\$48.99B</b>
<b>DW505</b>	Drop-Lock Hi-Hat Clutch .....	<b>48.99B</b>
<b>DW379</b>	Standard Hi-Hat Clutch.....	<b>33.99B</b>
<b>DW50P</b>	Turbo Pedal Plate.....	<b>46.99B</b>
<b>DW50TS</b>	Toe Stop for 5000 Series pedals .....	<b>9.99B</b>
<b>DW004</b>	Radius Rod .....	<b>5.00B</b>
<b>DW101</b>	2-way Pedal Beater .....	<b>33.99B</b>
<b>DW103</b>	Medium Felt Pedal Beater .....	<b>38.99B</b>
<b>DW105</b>	HardCore™ Rubber/Plastic Pedal Beater .....	<b>44.99B</b>
<b>DW107</b>	Flyweight Beater.....	<b>33.99B</b>
<b>DW017</b>	Turbo Hub Screw .....	<b>4.75B</b>
<b>DW018</b>	Turbo Hu with Bearing and "S" Hook.....	<b>11.00B</b>
<b>DW020</b>	Pedal Spring.....	<b>9.99B</b>
<b>DW025</b>	High Tension Spring Assembly.....	<b>24.99B</b>
<b>DW029</b>	Drum Key Screw Pack of 4 .....	<b>10.00B</b>
<b>DW007</b>	Link Connector.....	<b>3.00B</b>
<b>DW209</b>	DW5002 Linkage Drive Assembly with Universal Joint....	<b>61.00B</b>
<b>DW210</b>	DW5002 Linkage Drive Adjustment Assembly.....	<b>15.00B</b>
<b>DW211</b>	Complete DW5002 Linkage Drive Assembly.....	<b>124.00B</b>
<b>DW040</b>	Turbo Sprocket .....	<b>47.00B</b>
<b>DW040A</b>	Accelerator Sprocket.....	<b>47.00B</b>
<b>DW005</b>	Pedal Hinge .....	<b>19.99B</b>
<b>DWSM1204</b>	Double Pedal Chain.....	<b>21.99B</b>
<b>DW006</b>	Pedal Chain - Single.....	<b>16.00B</b>
<b>DWSM488</b>	Cymbal Stand Felts.....	<b>13.99B</b>

www.dwdrums.com

# DRUM WORKSHOP HARDWARE



DW9700 DW9710 DW9300 DW9100M DW9500 DW9799 DW9900 DW9934 DW9120M



DW5700 DW5710 DW3700 DW3710 DW5500D DW5500TD DW5100 DW5300



DW6500 DW6700 DW6300 DW6710

## DW 9000 Series Heavy-Duty Hardware

<b>DW9300</b>	Snare Stand with Removable Basket .....	<b>\$249.99B</b>
<b>DW9700</b>	Straight/Boom Cymbal Stand .....	<b>258.99B</b>
<b>DW9710</b>	Straight Cymbal Stand .....	<b>199.99B</b>
<b>DW9700XL</b>	Extra-heavy Straight/Boom Cymbal Stand.....	<b>299.99B</b>
<b>DW9100M</b>	Round-Seat Throne.....	<b>316.99B</b>
<b>DW9100AL</b>	Air Lift Pneumat Throne.....	<b>349.99B</b>
<b>DW9101</b>	Extra-low Tripod Base for Low-seated Players.....	<b>299.99B</b>
<b>DW9120AL</b>	Air Lift Pneumat Throne w/Backrest.....	<b>383.99B</b>
<b>DW9120M</b>	Tractor-Seat Throne.....	<b>333.99B</b>
<b>DW9900</b>	Double Tom Stand.....	<b>266.99B</b>
<b>DW9934</b>	Double Tom Stand with 934 Cymbal Arm.....	<b>333.99B</b>
<b>DW9999</b>	Single Tom/Cymbal Stand.....	<b>333.99B</b>
<b>DW9799</b>	Double Straight/Boom Cymbal Stand.....	<b>399.99B</b>
<b>DW9500</b>	Hi-Hat Stand .....	<b>499.99B</b>
<b>DW9502LB</b>	Cable/Remote Hi-Hat Stand (specify 4', 6' or 8' cable).....	<b>633.99B</b>
<b>DW9399</b>	Heavy Duty Tom/Snare Stand.....	<b>266.99B</b>
<b>DWDSCPH1</b>	Cymbal Stand iPad Holder .....	<b>49.99B</b>

## Heavy-Duty Hardware

<b>DW3500T</b>	Lightweight Hi Hat Stand .....	<b>\$233.99B</b>
<b>DW3302</b>	Concert Snare Stand .....	<b>149.99B</b>
<b>DW3700</b>	Straight/Boom Cymbal Stand.....	<b>133.99B</b>
<b>DW3710</b>	Straight Cymbal Stand .....	<b>116.99B</b>
<b>DW5100</b>	Drum Throne .....	<b>183.99B</b>
<b>DW5300</b>	Snare Stand .....	<b>174.99B</b>
<b>DW5500TD</b>	Delta 2-leg Hi-Hat Stand.....	<b>391.99B</b>
<b>DW5500D</b>	Delta 3-leg Hi-Hat Stand.....	<b>391.99B</b>
<b>DW5700</b>	Straight/Boom Cymbal Stand.....	<b>174.99B</b>
<b>DW5710</b>	Straight Cymbal Stand .....	<b>149.99B</b>

## DW 6000 Series Flush-Base Hardware

<b>DW6300</b>	Flush-Base Snare Stand .....	<b>\$154.99B</b>
<b>DW6700</b>	Flush-Base Straight/Boom Cymbal Stand .....	<b>154.99B</b>
<b>DW6710</b>	Flush-Base Straight Cymbal Stand.....	<b>138.99B</b>
<b>DW6700UL</b>	Ultra Light Cymbal Stand .....	<b>99.99B</b>
<b>DW6500</b>	Flush-Base Hi-Hat Stand .....	<b>233.99B</b>

# PERCUSSION ACCESSORIES

## DRUM CLINIC

The first complete assortment designed to get drum parts out of drawers and up onto the wall or counter, where you customers can see and buy them!



QUANT.	NO.	DESCR.	per Cd.
12 Cds.	DC10	Snare Drum Cord (2/Cd)	..\$1.29
6 Cds.	DC14	Cymbal Washers (2/Cd)	.....1.45
12 Cds.	DC18	Cymbal Sleeves (/Cd)	.....1.29
12 Cds.	DC22	Protector Pad (1/Cd)	.....1.29
6 Cds.	DC26	Rubber Tips (3/Cd)	.....2.69
6 Cds.	DC30	Pedal Strap (1/Cd)	.....2.35
12 Cds.	DC34	Drum Key (1/Cd)	.....2.05
4 Cds.	DC38	Speed Key (1/Cd)	.....4.29
6 Cds.	DC40	1 1/2" Tens. Rods (4/Cd)	.....4.00
6 Cds.	DC42	2" Tens. Rods (4/Cd)	.....4.00
4 Cds.	DC44	2 1/2" Tens. Rods (4/Cd)	.....4.00
3 Cds.	DC46	3" Tens. Rods (4/Cd)	.....5.35
3 Cds.	DC48	3 1/2" Tens. Rods (4/Cd)	.....5.35
2 Cds.	DC50	4" Tens. Rods (4/Cd)	.....5.35
4 Cds.	DC52	Spur Holder(1/Cd)	.....10.00



## DANMAR

**DAN618** – Drum tech kit. Contains 6 cym felts, 1 Hi-Hat felt, 2 metal cup washer, 2 clutch felts, 4 snare cords, 1 kick pad, 4 cym sleeves, 3 tension rods and washers.  
**\$22.50**

**DAN530** – Metal washers for Hi Hat bottom felt. 2 diameter.  
**Pack of 12 for \$33.00**

**DAN523** – 2 1/4" chrome plated tension rods for tom toms and snare drums.  
**Pack of 12 for \$12.00**

**3633** – 3" Chrome plated tension rods for tom toms and snare drums.  
**Pack of 12 for \$12.00**

**3636** – 4 1/2" chrome tension rods for tom toms and snare drums.  
**Pack of 12 for \$13.80**

**DAN519** – Heavy white felt muffler strip for bass drums improves the tone quality. Packaged in poly bag for pegboard hanging. Fits 18 to 24 drums. **\$4.80 ea.**

**DAN512** – Felt cymbal washers will assure you a rattle-free cymbal performance. Fits both American and foreign cymbal holders.  
**Pack of 12 for \$8.25**

**DAN512A** – Hi Hat Washer. A larger version of 512.  
**Pack of 12 for \$11.70**

**DAN512B** – Felt cymbal washers for Hi Hat clutch.  
**Pack of 12 for \$8.25**

**DAN513** – Cymbal insulating tubes fit over the stem of the cymbal rod below the threaded portion.  
**Pack of 24 for \$14.40**  
**DAN926 Pack of 24 (wht. nylon) \$15.00**  
**DAN926L Pack of 4 (lge. nylon) \$3.75**

**DAN529** – Chrome plated tension rod washers.  
**Pack of 50 for \$7.95**

**DAN514** – Cupped metal washer fits flat under cymbal felt.  
**Pack of 12 for \$25.70**

**DAN522** – Snare drum cord is special gauge and extra strength for tight snappy sound of snare drums. Long enough for parade drum snares.  
**Pack of 12 for \$12.00**

**DAN520** – Handy rubber tips for bass drum spurs protect against creeping and wear to the floor surface. Well worth using at all times.  
**Pack of 12 for \$18.00**

**DAN521** – Larger size rubber tips are perfect for bases of Hi Hat stands cymbal stands and snare drum stands to prevent wobbling.  
**Pack of 12 for \$21.00**

**UPFPS**  
**Pack of 12 for \$28.00**

**DAN515** – Chrome plated cymbal holder wing nuts.  
**Pack of 12 for \$40.50**  
**DAN515M Metric, 8mm .....\$36.00**

**DAN511** – 1/4/20 x 3/4 wing screw.  
**Pack of 12 for .....\$42.00**  
**BDL1618FTC Tom/Kick Riser .....139.99**

## ZILDJIAN PARTS

<b>P0900</b>	Cymbal Felts (10/Pk)	.....\$4.95
<b>P0906</b>	Hi Hat Felts (10/Pk)	.....8.95
<b>P0918</b>	Clutch Felts (10/Pk)	.....5.95
<b>P0912</b>	Cymbal Sleeves (10/Pk)	.....8.95
<b>P0800</b>	Drummers Survival Kit (10/Pk)	.....14.95

**HIHAT ROD**  
**DAN504 Metric .....\$19.50**

<b>BLACK DOTS</b>		
<b>UP3D</b>	3 1/2" Diameter, 20 per pack	.....\$23.00
<b>UP5D</b>	5 1/2" Diameter, 10 per pack	.....23.00
<b>UP7D</b>	7 1/2" Diameter, 5 per pack	.....15.50
<b>UP3457</b>	Asst. 3 of ea. size	.....24.00



## DRUMMERS GLOVES

**ZILDJIAN**  
Vented back with soft lambskin palm. Velcro closure.

<b>P0822</b>	Drummers Gloves - Med	.....\$29.95
<b>P0823</b>	Drummers Gloves - Large	.....29.95
<b>P0824</b>	Drummers Gloves - X-Large	.....29.95

**VATER PROFESSIONAL DRUMMING GLOVES**  
Synthetic leather with a breathable mesh backing and elasticated panels on the sides of the fingers.  
**VDGM Medium .....\$45.95**  
**VDGL Large .....45.95**

**VIC FIRTH**  
Fingerless handrum gloves with padded gel palms in black.  
**VFKDC3L Large .....\$20.25B**  
**VFKDC3XL X Large .....20.25B**

# DRUM ACCESSORIES

## KEY TENSION RODS



Chrome plated tension rods for snare drums and tom toms 2" (1/4 x 27).

**MT061** ..... **.85 ea.**

## SNARE CORD



Extra Heavy Braided Snare Cord In 12" Lengths.

**UPSC** 20 Pack ..... **\$17.00**

**UPSC12** 12 Pack ..... **10.50**

Stainless Steel, Nylon Coated Cable.

**TP4** ..... **\$12.00**

## ZILDJIAN PARTS



**P0900** Cymbal Felts (10/Pk) ..... **\$4.95**

**P0906** Hi Hat Felts (10/Pk) ..... **8.95**

**P0918** Clutch Felts (10/Pk) ..... **5.95**

**P0912** Cymbal Sleeves (10/Pk) ..... **8.95**

**P0800** Drummers Survival Kit (10/Pk) ..... **14.95**

## TENSION CASING SNARE DRUM



**MC033** 2" on center ..... **\$5.15 ea.**

**MC032A** Insert ..... **.72 ea.**

## TENSION CASING FLOOR & SIDE TOM



**MC032** 1 1/2" on center ..... **\$5.10 ea.**

**MC032A** Insert ..... **.72 ea.**

## TENSION CASING BASS DRUM



**MC034** 2" on center ..... **\$5.35 ea.**

## SNARE THROW OFF



Provides fast, positive control of snares.

**3386** ..... **\$19.95**

## DAMPENING SYSTEM



Dave Weckl Multi Adjustable Snare Damper

**HK2417** ..... **\$42.30**

## TONE CONTROL



Fits snare, parade, and tom-tom drums.

**M734** ..... **\$8.05**

## STRAINERS



**LUDWIG**

**LP32** Snare Butt for PSQP85 ..... **\$6.90B**

**LP80** Piccolo Strainer ..... **74.00\***

**LP85** Snare Throw Off ..... **28.50\***

## FELT MUFFLER STRIPS



White felt muffler strip for bass drums. Improves tone quality.

**M732** ..... **\$3.15**

**UPBF** Bag of 2 ..... **10.00**

## LEG REST



**3210** ..... **\$24.55**

**3553** ..... **31.10**

**UPPR400** ..... **43.00**

**3555** Pad, White ..... **22.05**

## SPURS



The pop out spur holds any bass drum firmly in place. The drummer can screw out the pointed spur or play with the hard rubber spur for carpeted or vinyl floors.

**UPSP11** ..... **\$109.00**

## DRUM PEDAL SPRING ASSEMBLY



**M6095** ..... **\$6.00**

**M6096** Spring only ..... **2.60**

**UPTRI** Triangle Only ..... **27.00 dz.**

## HI HAT CLUTCH



**SCDC** Gibraltar, Drop Clutch ..... **\$27.90**

**SCQRHHC** Gibraltar, Quick Release ..... **27.90**

**SCQRHHDC** Gibraltar, Quick Release, Drop clutch ..... **36.00**

**M6001** Standard Bore ..... **11.80**

**M8051** Large Bore ..... **18.00**

**LL2509** Ludwig, Quick Release ..... **29.40B**

# CANNON PERCUSSION

## 3 WAY CLAMP



Add an extra cymbal or tom tom in seconds. Fits 3/8" tubing.  
**UP3W** .....\$79.50

## MINI CLAMP



Connects small arms to stands, holders etc.  
**UP257** .....\$35.00

## MULTI CLAMP



Clamps arms, goosenecks etc. to stands.  
**UPCBC** .....\$41.00  
**BGC** .....\$21.60

## LP MOUNT ALL



**CYMBAL MOUNT**  
 Includes Z-shaped cymbal arm for mounting cymbals up to 16".  
**LP236A** .....\$56.00

## TOM HOLDER



Extra heavy tom holder with tom plates, casting, arms & screws.  
**UP8112A** (Complete).....\$217.50  
**UP8112B** (Casting).....\$52.00  
**UP8112C** (Tom Plate) .....\$19.75  
**UP8112D** (Tom Arm) .....\$63.00

## TOM HOLDER



**Double Tom**  
**UPDTM** (Complete) .....\$228.00  
**UPDTMA** (Arm) .....\$57.00  
**UP8112B** (Bass).....\$52.00  
**UPDTMT** (Tom Plate) .....\$40.00

## TOM HOLDER



**Double Tom**  
 Features heavy chrome plating, memory clamps and 3/4" tubing.  
**UPTH** Complete Holder.....\$197.90  
**UPTHA** Arm Only .....\$49.95  
**UPTHB** Base Casting .....\$38.00  
**UPTHC** Tom Plate .....\$30.00

## LP MOUNT ALL



**Percussion Bracket**  
 Includes angled rod for any 3/8" diameter mountable percussion.  
**LP236C** .....\$47.00

## TOM LEGS



**UPTL** Set of three legs with castings. ....\$93.00  
**UPTLDD** Heavy Duty.....\$137.25  
**UPTLL** Leg only .....\$16.00  
**UPTLC** Casting only.....\$16.00

## CYMBAL HOLDER



**CYMBAL HOLDER**  
 Clamps on bass drum.  
**DAN937** .....\$88.50  
**DAN1029** Concert Drum.....\$45.75

## DRUM ANCHOR



The rubber covered tips or steel pointed ends prevents the bass drum from creeping.  
**UP638** .....\$27.00

## SPURS



Heavy duty spurs w/Threaded Reversible rubber tips.  
**UPSP10** .....\$119.00/PR  
**UPSP10R** Tip only .....\$11.00/PR

## VALUE PACK

<b>UPCLT</b>	Clutch .....	\$22.00
<b>UP20</b>	14" Snare Wire .....	21.00
<b>UPCF</b>	Cymbal Felts 10 pack .....	15.00
<b>UPCFT</b>	Thick Cymbal Felts.....	16.00
<b>8MMUPCBSD</b>	Deluxe Cymbal Sleeves 12 pack.....	44.00
<b>UPCLTD</b>	Drop Clutch .....	38.00
<b>8MMUPWN</b>	Wing Nuts 12 pack .....	31.00
<b>UPCMW</b>	Curved Metal Washers 12 pack.....	21.00
<b>UPSK</b>	Speed Key .....	12.90
<b>UPSC</b>	Snare Cord 20 pack.....	17.00
<b>UPDK2</b>	Drum Keys 6 pack .....	9.00
<b>UP632TS2</b>	2" Tension Rods 12 pack.....	16.00

1 pack each in display  
**UPCVP** .....\$215.90



www.universalpercussion.com

## BOOM ARMS



Attaches to stands and boom cymbals where desired.  
**UPCBA** .....\$75.00

# CANNON PERCUSSION

## CYMBAL SLEEVES



Prolong the life of cymbals. (Bag of 24)  
**UPCBSR** Rubber Sleeves .....\$15.50  
**UPCBSN** Nylon Sleeves .....18.00  
**UPCBSN8MM** Large .....18.00  
 Deluxe cymbal sleeve with plastic washer attached.  
**UPCBSD** (Bag of 12) .....\$44.00  
**UPCBSD6** (Bag of 6) .....23.00  
**8MMUPCBSD** (Bag of 12) .....44.00

## CYMBAL TOPS



Nylon, Threaded Cymbal Tops. Replaces wing nut.  
**UPNTT** 12 pack, 6 mm .....\$24.00  
**UPNTT6** 6 pack, 6 mm .....17.00  
**UPEZ** Quick release .....20.00  
**VATSNB** Slick Nut .....16.99  
**8MMUPNTT** 12 pk, 8 mm .....28.00  
**8MMUPNTT6** 6 pk, 8 mm .....18.75

## METAL WASHERS



**CURVED**  
**UPHW** 12 pack, Hi Hat .....\$28.00  
**UPHW4** 4 pack, Hi Hat .....12.00  
**UPCMW** 12 pack, Cymbal .....21.00  
**UPCMW4** 4 pack, Cymbal .....10.00

## RUBBER TIPS



For Pro Series hardware.  
**UPSTL** 4 pack, large .....\$14.50  
**UPSTM** 12 pack, medium .....22.50  
**UPSTS** 12 pack, small .....18.00

## S SPRINGS



S. Springs fit most U.S. and imported bass drum pedals.  
**UPSPP** (Bag of 5) .....\$20.00  
**UPCSA** Spring Assembly .....12.95

## WING NUTS



Extra large metric wing nuts, 6 mm.  
**UPWN** (Bag of 12) .....\$31.00  
**UPWN6** (Bag of 6) .....17.00  
 Standard Wing Nuts, 1/4x20.  
**UPWNS** (Bag of 12) .....32.00  
**UPWN6S** (Bag of 6) .....17.00  
**8MMUPWN** 12 pk., 8mm .....31.00  
**8MMUPWN6** 6 pk., 8mm .....17.00

## TENSION RODS



(Bag of 12)  
**UP632TS1** End to End 1 1/2" .....\$16.00  
**UP632TS2** End to End 2" .....16.00  
**UP632TS2.5** End to End 2 1/2" .....20.00  
**UP632TS3** End to End 3" .....22.00  
**UP632TS4** End to End 4" .....24.00  
**UP632TS5** End to End 5" .....26.00  
**UP632TS6** End to End 6" .....28.00  
**UP632TS7** End to End 7" .....31.00  
**UP632TS8** End to End 8" .....32.00  
**UP632W** Bag of 50 washers .....13.00  
**UPNW** Nylon Washers (12) .....10.00

## T RODS/CLAWS



Chrome Plated Bass Drum Claws.  
**UPCL** (Bag of 10) .....\$38.00  
 Chrome Plated T-Rods for Bass Drums  
**UPTR** (Bag of 10) .....\$52.00

## LUGS/LUG LOCKS



**UP632A** Bass, 12 Pack .....\$67.00  
**UP632B** Snare, 12 pack .....67.00  
**UP632C** Tom, 12 pack .....65.75  
**UPLGS** Lug Screws (12) .....6.50  
**UPLN** Lug Nuts (12) .....18.00  
**SCGLL** Gibraltar Luglocks .....6.30/6 pk.

## CYMBAL FELTS



Felt washers for Hi-Hat Stands.  
**UPHF** (Bag of 10) .....\$12.00  
 Clutch-Felts fit all Hi-Hat clutches.  
**UPCLF** (Bag of 10) .....11.00  
 Felt washers for all cymbal Stands.  
**UPCF** (Bag of 10) .....15.00  
 Extra thick felt washers  
**UPCFT** (Bag of 10) .....16.00

## HI HAT SEATS



Fits most heavy duty Hi Hat stands.  
**UPHSD** .....\$13.50  
 Hard plastic seating fits most Hi-Hat stands.  
**UPHHS** .....12.00

## STRAINER



**UPSS** Snare throw-off w/back plate .....\$32.00  
**UPSSS** Strainer only .....26.00  
**UPSSB** Butt only .....7.00

## HI HAT CLUTCHES



Heavy duty clutch  
**UPCLT** .....\$22.00  
 Light duty clutch  
**UPCLTR** .....17.00  
**UPCLTD** Drop clutch .....38.00  
**DW505** Drop clutch .....48.99B



**3825** .....\$10.95  
**3826** Heavy Duty .....12.00



**DW379** Clutch .....\$33.00B

## STRAINER



Deluxe strainer works on standard and piccolo snare drums.  
**UP333** .....\$43.00  
**TRICK PERCUSSION**  
 Super smooth, deluxe strainer  
**GS007A** Aluminum .....\$110.00B  
**GS007BK** Black .....110.00B

# DRUM ACCESSORIES

## TOM TOM HOLDERS



<b>MTH501</b>	Tom tom mounting bracket .....	<b>\$18.20</b>
<b>MTH502</b>	Tom tom holder arm only 3/4" O.D. ....	<b>47.45</b>
<b>MTH503</b>	Bass drum bracket .....	<b>46.60</b>
<b>UPDTMA</b>	7/8" O.D. Tom Arm .....	<b>57.00</b>

## BASS DRUM SPURS



<b>M7292</b>	Spur with tip .....	<b>\$12.40</b>
<b>M7291</b>	Spur bracket with screws .....	<b>9.00</b>
<b>UPSP</b>	Complete Set .....	<b>36.00</b>
<b>DAN938</b>	Vintage Style .....	<b>45.00</b>
<b>DAN1036</b>	Ludwig Retro Spurs .....	<b>43.50 pr.</b>

## FLOOR TOM LEGS



Shaped legs with wide spread provide better balance.

<b>M8811</b>	Floor tom leg bracket .....	<b>\$9.70</b>
<b>M8813</b>	Leg only .....	<b>11.75</b>

## CYMBAL HOLDER



Clamps on cymbal stand. Holds up to 14" cymbal.

<b>DAN309</b>	w/Tilter .....	<b>\$55.50</b>
<b>UPCYH</b>	.....	<b>41.50</b>

## T ROD & CLAW



<b>MD031</b>	Bass drum claw only .....	<b>\$1.95</b>
<b>MT064</b>	Trod only .....	<b>3.85</b>

## SUSPENDERS



Drum Mounting System

<b>DSS3504</b>	12" 4-Hole .....	<b>\$77.00</b>
<b>DSS3764</b>	13" 4-Hole .....	<b>79.00</b>
<b>DSS4016</b>	14" 6-Hole .....	<b>81.00</b>
<b>DSS4276</b>	15" 6-Hole .....	<b>79.50</b>
<b>DSS4556</b>	16" 6-Hole .....	<b>90.00</b>

## BASS DRUM HOOPS

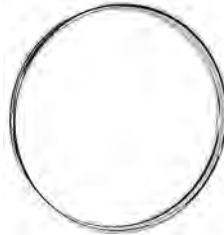

<b>M20BH</b>	20" metal hoop .....	<b>\$27.20</b>
<b>M22BH</b>	22" metal hoop .....	<b>29.40</b>
<b>M24BH</b>	24" metal hoop .....	<b>32.40</b>

## DIE CAST HOOPS



Extra thick chrome plated die cast hoops.

<b>UPB8DC</b>	14", 8 hole batter .....	<b>\$135.00</b>
<b>UPS8DC</b>	14", 8 hole snare side .....	<b>144.00</b>
<b>UPS10DC</b>	14", 10 hole snare side .....	<b>142.00</b>
<b>UPB10DC</b>	14", 10 hole batter side .....	<b>135.00</b>

## BASS DRUM HOOPS



6 Ply Maple, 1 1/2" Wide

<b>UP18WD</b>	18" wood hoop, natural .....	<b>\$62.75</b>
<b>UP20WD</b>	20" wood hoop, natural .....	<b>66.30</b>
<b>UP22WD</b>	22" wood hoop, natural .....	<b>71.75</b>
<b>UP24WD</b>	24" wood hoop, natural .....	<b>77.75</b>
<b>UP26WD</b>	26" wood hoop, natural .....	<b>84.50</b>
<b>UP28WD</b>	28" wood hoop, natural .....	<b>89.50</b>
<b>UPCHP</b>	Wood hoop protector .....	<b>11.00/3</b>

## TRIPLE FLANGED HOOPS



<b>M6BH</b>	6" tom tom hoop, 4 lug .....	<b>\$14.00</b>
<b>M8BH</b>	8" tom tom hoop, 4 lug .....	<b>14.40</b>
<b>M10BH</b>	10" tom tom hoop, 6 lug .....	<b>14.80</b>
<b>M12BH</b>	12" tom tom hoop, 6 lug .....	<b>15.20</b>
<b>M13BH</b>	13" tom tom hoop, 6 lug .....	<b>15.40</b>
<b>M14SH6</b>	14" snare lug side 6 lug .....	<b>15.60</b>
<b>M14BH6</b>	14" batter side, 6 lug .....	<b>15.60</b>

<b>M14BH8</b>	14" batter side, 8 lug .....	<b>\$15.60</b>
<b>M14SH8</b>	14" snare side, 8 lug .....	<b>15.60</b>
<b>M14BH10</b>	14" batter side, 10 lug .....	<b>15.60</b>
<b>M14SH10</b>	14" snare side, 10 lug .....	<b>15.60</b>
<b>UP15B8</b>	15" batter side, 8 lug .....	<b>20.00</b>
<b>M16BH</b>	16" tom tom hoop, 8 lug .....	<b>16.80</b>
<b>M18BH</b>	18" tom tom hoop, 8 lug .....	<b>21.20</b>



## LP CLAWS



LP592A	Mic.....	\$51.00
LP592	Clamp only.....	41.00
LP592B	Percussion.....	51.00
LP592S	Splash.....	51.00

## DRUM MUFFLERS



DAN920	Bass Drum.....	\$45.00
UPTC	Toms & Snares.....	21.00
UPTC1	Toms & Snares (Internal).....	19.00

## GIG RUG



5½ ft. square – Large enough to go under all your drums and stands. 20" Barrier – Allows bass drum to be off-set from center. Lightweight.

KCP5	Kaces.....	\$88.55
Economy drum rug, 4 ft. x 5 ft., features durable heavy-duty and no-slip bottom.		
KCP45	Kaces.....	\$56.70
UPDR	.....	90.00

## GROVER PRO TEMPLE BLOCKS



Our "Open Tone" temple blocks are hand-crafted in the USA using high quality Baltic birch.

**TPBX** Standard Set of 5 Blocks with Mounting Bar...\$357.00\*

## RHYTHM TECH



### THE CRASHER

Loud, intense, and, best of all, unique: The Crasher delivers a bright, tight metallic sound that's unavailable in any other percussion accessory. Perfect for all types of music and great as a recording sound effect. Available in two sizes (11" and 15")

RTRC11	Crasher (11").....	\$53.95
RTRC15	Crasher (15").....	56.95

## THE ORIGINAL SWIRLYGIG



Intended for use on half-inch tubing, the Original SwirlyGig fits snugly on a standard mic stand. It is made out of resilient spring steel, then coated in protective PVC for grip and durability, in black.

SG1000	.....	\$14.99
SG2000	1" Tube.....	14.99
SG8020	1¼" Tube (Skiffdaddy).....	14.99

## PRO CADDY RAX



Pro Caddy Rax easily attaches to any drum, cymbal, hi-hat stand, mic stand, or music stand. Holds cup, can, or bottle, and towel.

PCR1	Fits Med. Diameter Stands.....	\$12.98
KM1602BK	Drink Holder, Blk...20.00	
MC	Mic Caddy.....	31.50
MSDDT	String Swing Drink Holder.....	24.00
VATVDH	Vater Drink Holder.....	26.95

## ACOUSTI BLOX



AB7500CB	7" X 5¼".....	\$19.50
AB8500CB	8½" X 5¾".....	21.25

## JAM BELLS



LP1231	High Bell, Blue.....	\$49.00
LP1233	Low Bell, Red.....	50.00

## JAM TAMB



### LP JAM TAMB

6 pairs of nickel-plated steel alloy jingles produce a bright, projecting sound. Rubber surface for stick rebound and comfortable hand playing. LP heavy duty eye-bolt mounting bracket included. Use on any ¾" rod and with the LP Gajate Bracket (LP388N). Great for a tambourine accent in any drum kit or percussion setup.

LP1207T	.....	\$58.00
---------	-------	---------

## RACKS



Holds Temple Blocks, Cow Bells or other percussion instruments.		
LP472	Mini Everything.....	\$ 84.00
LP372	Everything.....	139.00

## LATIN PERCUSSION JAM BLOCKS/GRANITE BLOCKS/BLAST BLOCKS



### JAM BLOCKS

LP1204	LP Piccolo Jam Block®	Orange	Very High Pitch.....	\$39.00
LP1205	LP Jam Block®	Blue	High Pitch.....	46.00
LP1207	LP Jam Block®	Red	Medium Pitch.....	52.00
LP1208-K	LP Stealth Jam Block®	Black	Medium Pitch.....	67.00
LP1209	LP Guiro Jam Block®	Purple	Low Pitch.....	64.00
LP1202	90° Bracket.....			24.00
LP1203	Mounting Bracket.....			24.00



### GRANITE BLOCKS

This five block set is tuned to recreate the tones of the traditional Chinese temple blocks. The set comes with a rugged steel mounting bracket, that will attach to any stand from 1" to ¾" in diameter.

LP1210	Universal.....	\$345.00
LP1220	Mallets.....	28.00



### BLAST BLOCKS

Sharp and cutting with explosive punch.		
LP1305	Yellow, High.....	\$41.00
LP1307	Green, Low.....	43.00

## PEDAL BEATERS

<b>DANMAR</b>		
<b>DAN305</b>	Wood.....	<b>\$30.75</b>
<b>DAN306</b>	Felt.....	<b>31.50</b>
<b>DAN305B</b>	Wood bent shaft.....	<b>33.00</b>
<b>DAN207</b>	Tommy Aldridge.....	<b>32.25</b>

<b>VATER</b>		
<b>VATBDN</b>	Wood, Natural.....	<b>\$36.99</b>
<b>VATBDF</b>	Felt.....	<b>37.99</b>
<b>VATBDR</b>	Wood, Red.....	<b>36.99</b>
<b>VATPBB</b>	Polyethelene.....	<b>37.99</b>
<b>VATBVB</b>	Bomber.....	<b>40.99</b>
<b>VATBLRB</b>	Bomber, Long.....	<b>41.49</b>

## VIC FIRTH BASS BEATERS

<b>VFVKB1</b>	Felt, Radial, Med-Hard.....	<b>39.95</b>
<b>VFVKB2</b>	Wood, Radial, Hard Maple.....	<b>34.95</b>
<b>VFVKB3</b>	Felt & Fleece, Oval, Med-Felt.....	<b>42.95</b>

<b>DUPLEX</b>		
<b>3262</b>	Wood for "bop" work.....	<b>\$ 9.95</b>
<b>3264</b>	Lamb's Wool.....	<b>13.95</b>
<b>3261</b>	Solid White Felt.....	<b>19.50</b>
<b>3265</b>	Cork, light, fast.....	<b>10.95</b>
<b>M6091</b>	Felt.....	<b>27.55</b>

<b>DW</b>		
<b>DW101</b>	Combo Beater.....	<b>\$33.99B</b>
<b>DW103</b>	Med Felt.....	<b>38.99B</b>
<b>DW105</b>	Hardcore Beater.....	<b>44.99B</b>
<b>DW107</b>	Flyweight Beater.....	<b>33.99B</b>
<b>PDAX101</b>	Combo Beater.....	<b>19.00</b>

## RHYTHM TECH

<b>RT7100</b>	Balance Beater.....	<b>\$32.95</b>
---------------	---------------------	----------------

## LP JINGLE KICK

Extremely durable, hi-impact jingle stick with 1/4" rod. 6 pairs of dimpled brass jingles that produce a distinct, crisp sound. Use with the LP Fusheki (LP281F), most bass drum pedals or as a bass drum beater.

<b>LP182</b>	Jingle Kick.....	<b>\$46.00</b>
<b>LP182S</b>	Jingle Kick Nickel-Plated Steel.....	<b>39.00</b>

## SNAPPY SNARES



<b>12 STRANDS</b>		
<b>3351</b>	For 13" Drum, Duplex.....	<b>\$8.55</b>
<b>3352</b>	For 14" Drum, Duplex.....	<b>8.55</b>
<b>LL1929</b>	Ludwig.....	<b>26.00B</b>

<b>16 STRANDS</b>		
<b>3356</b>	For 14" Drum, Duplex.....	<b>\$9.00</b>

<b>20 STRANDS</b>		
<b>3361</b>	For 14" Drum, Duplex.....	<b>\$9.55</b>
<b>3362</b>	For 15" Drum, Duplex.....	<b>9.55</b>
<b>3395</b>	For 14" Drum, 42 strand, Duplex.....	<b>21.55</b>
<b>LL1930</b>	Ludwig.....	<b>17.00B</b>

<b>GUT TONE</b>		
<b>HK21150915"</b>	Drum, Remo.....	<b>\$39.60</b>

<b>CANNON PERCUSSION</b>		
<b>UP20</b>	14" Drum, 20 Strands.....	<b>\$21.00</b>
<b>UP20D</b>	14" Drum, 20 Strands.....	<b>28.50</b>
<b>UP2025</b>	14" Drum, 25 Strands.....	<b>21.50</b>
<b>UP20XL</b>	Extended Snare.....	<b>19.00</b>
<b>UP2012</b>	12" Drum, 12 Strands.....	<b>13.25</b>
<b>UP2013</b>	13" Drum, 20 Strands.....	<b>19.00</b>
<b>UP2015</b>	15" Drum, 20 Strands.....	<b>15.25</b>
<b>UP20L</b>	Fits Ludwig, Swivel Mount.....	<b>38.00</b>
<b>UP20D12</b>	12" Sonar.....	<b>21.00</b>
<b>UP203</b>	14" Drum, 20 Strands, Extended.....	<b>22.50</b>
<b>UP42</b>	14" Drum, 42 Strands.....	<b>32.00</b>
<b>MPS9</b>	Plastic Strip.....	<b>.52</b>

## PEDAL BEATERS

<b>DAN205</b>	Wood.....	<b>\$31.50</b>
<b>DAN206</b>	Felt.....	<b>32.40</b>
<b>DAN205A</b>	Wood, extra long, 7".....	<b>34.50</b>
<b>DAN206A</b>	Felt, extra long, 7".....	<b>35.40</b>
<b>DAN206S</b>	Square, felt.....	<b>32.25</b>
<b>UPKAB</b>	Extra Hard Felt.....	<b>29.00</b>
<b>PROIV4</b>	Trick.....	<b>49.99*</b>

<b>LUDWIG</b>		
<b>LL1285</b>	Speed King Wool.....	<b>\$30.45</b>
<b>LL1286</b>	Speed King Hard Felt.....	<b>27.30</b>
<b>LL1287</b>	Speed King Wood.....	<b>27.30</b>

## BLACK SWAMP PERCUSSION CABLE SNARES

Standard models lie totally on the bottom head, not passing over the bearing edge.

**Standard style for 14" Drum, Blue Coated Cable**  
16 strands of blue coated cable supplies a drier sound, responding best at medium to loud dynamics. Fits 14" snare drum.

<b>BSS14C</b>	.....	<b>\$90.00</b>
---------------	-------	----------------

**Standard style for 14" Drum, Stainless Cable**  
16 strands of stainless cable supplies a brighter and wetter sound than coated cable. Fits 14" snare drum.

<b>BSS14S</b>	.....	<b>\$90.00</b>
---------------	-------	----------------

**Standards style for 14" Drum, Blue Coated Stainless Steel**

12 strands of blue coated cable, combined with 6 strands of stainless cable, supplies a balanced sound. Fits 14" snare drum.

<b>BSS14CS</b>	.....	<b>\$90.00</b>
----------------	-------	----------------

**Wrap-Around models** span the diameter of the drum and pass over the bearing edge, requiring a snare bed for increased response and sensitivity.

**Wrap-around style for 14" Drum, Blue Coated Cable**

16 strands of blue coated cable supplies a drier sound. Fits 14" snare drum.

<b>BSW14C</b>	.....	<b>\$90.00</b>
---------------	-------	----------------

**Wrap-around style for 14" Drum, Stainless Cable**  
16 strands of stainless cable supplies a brighter and wetter sound than coated cable, responding best at soft to medium dynamics. Fits 14" snare drum.

<b>BSW14S</b>	.....	<b>\$90.00</b>
---------------	-------	----------------

**Wrap-around style for 14" drum, Blue Coated Stainless Steel Cable**

12 strands of blue coated cable, combined with 6 strands of stainless cable, supplies a balanced sound. Fits 14" snare drum.

<b>BSW14CS</b>	.....	<b>\$90.00</b>
----------------	-------	----------------

**Wrap-around style for 14" Drum, Gold Coated Cable**

12 strands of thicker gold coated cable supplies a traditional gut sound. Fits 14" snare drum.

<b>BSW14G</b>	.....	<b>\$90.00</b>
---------------	-------	----------------

## RHYTHM TECH

<b>RT7000</b>	Active Snare.....	<b>\$36.95</b>
<b>RT7013</b>	Active Sn Picc 13.....	<b>33.95</b>
<b>RTASR</b>	Replac. Assem.....	<b>19.95</b>

## PURESOUND SNARES



<b>E1412</b>	14" - 12 Offset Strands.....	<b>\$30.00</b>
<b>E1414</b>	14" - 14 Offset Strands.....	<b>30.00</b>
<b>E1416</b>	14" - 16 Strands.....	<b>30.00</b>
<b>P1316</b>	13" - 16 Strands.....	<b>30.00</b>
<b>P1416</b>	14" - 16 Strands.....	<b>30.00</b>
<b>P1420</b>	14" - 20 Strands.....	<b>30.00</b>
<b>P1424</b>	14" - 24 Strands.....	<b>30.00</b>
<b>B1420</b>	14" - 20" Blasters.....	<b>30.00</b>
<b>MC4</b>	4 Blue Cable Straps.....	<b>11.99</b>
<b>MT4</b>	Mylar Strands.....	<b>10.99</b>
<b>PSMS4</b>	4 Black Nylon Straps.....	<b>10.99</b>
<b>CPS1420</b>	14" - 20 Strands Custom Pro Steel.....	<b>34.99</b>

## DRUM KEYS



<b>UPSK</b>	Speed Key.....	<b>\$12.90</b>
<b>4248</b>	Speed Key.....	<b>6.15</b>
<b>DAN526</b>	Speed Key.....	<b>12.00</b>



<b>4244</b>	CB.....	<b>\$2.85</b>
<b>MK024</b>	Royce.....	<b>3.85</b>
<b>LP41</b>	Ludwig.....	<b>6.00B</b>
<b>DAN922</b>	Danmar.....	<b>3.45</b>
<b>Z3240</b>	Zildjian Z Key.....	<b>9.95</b>
<b>IA8</b>	Keyring.....	<b>2.25</b>
<b>Z6820</b>	Drumstick Keyring Zildjian.....	<b>4.95*</b>
<b>DZAP</b>	Drum Zap It.....	<b>6.40</b>
<b>UPDK</b>	6 Pack.....	<b>23.00</b>
<b>UPDK2</b>	2 Pack.....	<b>9.00</b>
<b>LP15011</b>	Ludwig Timp.....	<b>34.00B</b>



<b>DK40</b>	Pro Mark, Marching Drum.....	<b>\$40.00</b>
<b>SCTDKY</b>	1/4" Socket.....	<b>5.95</b>
<b>GTDKY1</b>	T Handle Key 7".....	<b>19.95</b>
<b>WDK001</b>	Ergo Key/Wedgie.....	<b>3.00</b>
<b>P25TDW</b>	Dynasty T Handle Key.....	<b>12.00</b>
<b>GTDMT1</b>	GrooveTech Drum Multi-Tool.....	<b>23.95</b>

## RATCHET KEYS



UPRA

<b>UPRA</b>	Cannon.....	<b>\$21.00</b>
<b>PR62</b>	Pro Mark, Hi Torque.....	<b>22.00</b>
<b>HK245059</b>	Swivel Head, Djembe.....	<b>19.40</b>
<b>RT7350</b>	Memokey.....	<b>40.95</b>
<b>HK245052</b>	Remo Socket Key.....	<b>3.15</b>
<b>UPCRT</b>	Drill Bit/Dum Key.....	<b>15.00</b>
<b>LL111</b>	Ludwig Torque.....	<b>22.00B</b>
<b>DK30</b>	Low Torque.....	<b>35.00</b>
<b>SCTDKY</b>	1/4" Socket.....	<b>5.95</b>

## DRUM TORQUES



<b>DQ1</b>	.....	<b>\$68.00</b>
<b>DQSOC</b>	Replacement Sockets.....	<b>11.00</b>
<b>RT7350</b>	Memokey.....	<b>40.95</b>

# ETHNIC PERCUSSION



## MARACAS

Authentic wood maracas are completely hand painted and finished to a very high gloss.

- W4958** Medium, Colored.....**\$19.95**
- W4959** Medium, Natural.....**19.95**
- W4956** Large, Colored.....**20.95**
- W4957** Large, Natural.....**20.95**



## MARACAS

Made from a very dark, exotic wood from Pakistan, these maracas are slightly heavier and louder than their Mexican counterparts. They produce a louder, more "cutting" sound.

- W4962** Medium, Colored.....**\$20.95**



## MARACAS

- LP281**.....**\$36.00**
- LP281R** Refillable.....**43.00**
- LP389** Fiber.....**57.00**
- M283** Plastic.....**34.00**
- LP394** Macho Rawhide.....**102.00**



## LP TWIST SHAKERS

LP's new patent pending Twist Shaker is a twin set of shakers that have a twisting lock mechanism which allows them to be played in one hand as a set or one in each hand.

- LP441TL** Loud Twist Shaker – Red.....**\$24.99**
- LP441TM** Medium Twist Shaker – Blue.....**24.99**
- LP441TS** Soft Twist Shaker – Yellow.....**24.99**



## MINI MARACAS

- BLPXX** .....**\$7.00 pr.**

(14) Blue, (16) Black, (18) Green, (20) Purple  
(22) Orange, (24) Red, (26) Yellow



## MARACAS

- TCFMM** Mini, Fiber.....**\$10.95**
- TCFML** Large, Fiber.....**16.95**
- HM300** Traditional Wood.....**15.50**
- V600** Vic Firth.....**22.30**



## CHICKITAS

Plastic egg shaped shakers with handle.

- LPR010XX**.....**\$8.99/pr.**
- LP010GLO** Glow in Dark.....**8.99/pr**
- LP013** Chickita Twin.....**8.99/ea.**
- LP015** Hi-hat Chickita.....**27.00/ea.**

Bubble Gum (BG), Blueberry (BL),  
Cherry (CH), Grape (GP)

## SANTANA CHICK-ITAS

- LPR012** 1 Pair.....**\$9.00**

Black (BK), Cherry (CH), Sunshine (SS)



## MARAQUITAS

Shakers On a Stick

- RT2230** Red.....**\$8.95/pr.**
- RT2240** Blue.....**8.95/pr.**
- RT2250** Yellow.....**8.95/pr.**
- RT2280** Purple.....**8.95/pr.**

## MARACAS

- RT2300** Fiber, Foam Grip.....**\$25.95 pr.**



## SHAKERS

Skull Shakers available in: Green (G), Red (R), Yellow (Y), Black (BK), Purple (PU), Bone (BO), Glow (GL)

- BBS**.....**\$4.00**
- BB12A** 12 Assorted.....**50.40**
- BB12G** 12 Glow.....**50.40**
- BB24A** 24 Assorted.....**97.80**
- BB24C** 24 Glow.....**97.80**



## EGG SHAKERS

Unique, miniature egg shaped shakers.

- RT2110** 24 Pack.....**\$51.95**
- 14024** 24 Pack – Red, Yellow, Blue.....**39.55**
- OSC48M** Two Pack.....**10.00**



## GOJO BAG

A basic, rhythmic pulse can be created by simply opening and closing your hand around a Go-Jo bag.  
**LP359**.....**\$14.00**



## EGG SHAKERS

- LPR001BD48** Box, 48.....**\$126.00**
- LPR004SS** Yellow.....**7.00/pr.**
- LP004GLO** Glow in Dark.....**7.99/pr.**
- LPR003** Santana BK, CH, GP.....**8.00**
- 9102** Gel Shakes (36).....**112.10**
- 9103** Black Shakes (36).....**105.30**
- 9110** Gel Glo Shakes (36).....**118.70**
- LP016** Set of Three.....**13.00**

# LATIN PERCUSSION

## AFUCHE (CABASA)

The LP Afuche/Cabasa was designed to create rhythmic scraping sounds and patterns. The beads can be manipulated against the textured steel or the instrument can be spun.



LP234BK

LP234BK	Mini, Black .....	\$41.00
LP234A	Standard, Natural.....	61.00
LP234A45	45th Anniversary .....	54.00
LP234B	Large .....	71.00
LP234C	Deluxe .....	81.00
LP480	Traditional (Gourd Style).....	113.00
LP325	Holder for LP234A.....	61.00

## VIBRA SLAP



LP209

LP208	Standard Model .....	\$70.00
LP209	Deluxe Model .....	78.00
LP425D	Metal Chamber .....	90.00
LP444	Mounting Bracket .....	26.00

## MARACAS



LP281	.....	\$34.00
LP281R	Refillable.....	41.00
LP389	Fiber.....	54.00
LP394	Rawhide, Macho.....	97.00

## FLEX-A-TONE



LP15

LP15	Standard .....	\$46.00
LP18	Large .....	64.00



LP231A

## AGOGO BELLS

LP231A	Standard .....	\$60.99
LP231B	Deluxe .....	62.99
LP579	Large, Dry .....	70.99
LP571	Mounting Bracket .....	28.00

## PLASTIC

LP617	Double, Mountable .....	\$47.99
-------	-------------------------	---------

## TIMBALE STIX



LP246A	12 Pr., 7/16" .....	\$42.00
LP246B	6 Pr., 3/8" .....	31.00
LP246C	6 Pr., 7/16" .....	33.00
LP246D	4 Pr., 1/2" .....	39.00
LP655	Tito Puente Original.....	15.00
LP656	Tito Puente Classic.....	15.00

## LP SESSION SHAKERS

Perfectly weighted for a controlled sound. Features rubber-like grip surface. Available in two sizes: 5" & 9".

LP446S	.....	\$18.99
LP446L	.....	21.99

## SHAKE-IT

LP440	Standard .....	\$29.00
LP441	Soft Shake .....	26.00

## MULTI GUIRO

Two surfaces, each with its own unique sound. The Multi Guiro is also a versatile shaker.

LP452	.....	\$75.00
LP451	Large .....	86.00
LP303	Mini Merengue Guria .....	80.00
LP304	Professional Merengue Guria.....	146.00
LP305	Merengue Guria .....	146.00
LP334	Scraper Metal.....	7.00

# LATIN PERCUSSION COWBELLS



## BLACK BEAUTY

Originally designed for Cha Cha, it is our most popular model. It's also very popular with rock drummers. Features the exclusive SONACURVE playing surface for maximum playing ease and volume.

LP204A	Black Beauty Cowbell .....	\$47.99
LP204B	Deluxe Black Beauty Cowbell (Chrome) .....	59.99

## BLACK BEAUTY SR

This bell was inspired by the legendary Black Beauty® Cowbell. A whole step lower in pitch, the Black Beauty Sr.® has the same dry sound and dynamic approach.

LP228	.....	\$48.99
-------	-------	---------

## MAMBO

This bell has a unique "creased" playing surface for maximum playing ease and volume. Its use is similar to that of the LP205 Timbale Cowbell and is chosen where a deeper sound is desired.

LP229	Mambo Cowbell .....	\$59.99
LP268	Deluxe Beater .....	17.00
LP308	Bolt Assembly .....	13.00

## LP HERITAGE SERIES CUBAN COWBELLS

LP205QBA	8" Cuban Flag Timbale Bell, Mountable .....	\$59.99
ES4QBA	7 1/4" Cuban Flag Salsa Bell, Hand Held .....	59.99

## LP HERITAGE SERIES COWBELLS

LP204PR	5" Puerto Rican Black Beauty Cowbell, Mountable.....	\$46.99
LP205PR	8" Puerto Rican Timbale Cowbell, Mountable.....	59.99
ES4PR	7.75" Puerto Rican Salsa Cowbell, Hand Held.....	59.99
LP900PR	3.5" Puerto Rican Cowbell on a 4" Handle .....	31.00

## BONGO

Made for hand-held use, the BONGO COWBELL is made of the heaviest gauge material.

LP206A	Bongo Cowbell .....	\$63.99
LP206B	Bongo Cowbell, chrome .....	79.99
LP207	Cowbell Beater.....	14.00

## TIMBALE

A perfect companion to the LP204 model when used on the Timbale set.

LP205	Timbale Cowbell .....	\$59.99
-------	-----------------------	---------

## SALSA

Latin percussion cowbells that are higher in pitch with a more lively Latin Salsa sound. **All brushed steel.**

ES2	ChaCha.....	\$50.99
ES5	Timbale.....	64.99
ES6	Timbale/Uptown high pitch .....	64.99
ES8	Songo .....	64.99
LPES9	Sergio Bongo .....	61.99
ES12	Cha Cha Deep .....	50.99
ES17	Big Band Timbale .....	64.99

## ROCK

Used for rock and other up tempo rhythms.

LP007	.....	\$60.99
LP007BD	Diablo Red Rock .....	63.99
LP008	Rock Ridge Rider, Red .....	79.99
LP009	Classic Ridge Rider, Yellow.....	79.99
LP009TB	LP Travis Barker Ridge Rider Cowbell .....	77.99

PRICES SUBJECT TO CHANGE WITHOUT NOTICE

www.lpmusic.com

# LATIN PERCUSSION



## EZ GRIP COWBELL

Cowbell mounted on a wooden handle. Delivers dynamic open tone.

**LPA900BK** Black .....\$28.00  
**LPA900R** Red.....\$28.00



## BAMBOO SHAKERS

Bamboo shell with rawhide heads. Three sizes: small, medium and large. Shake "freely" or gently press on the heads to alter the pitch.

**TBSS** Bamboo Shaker, SM.....\$12.60  
**TBSM** Bamboo Shaker, MD.....\$18.00  
**TBSL** Bamboo Shaker, LG.....\$18.90



## LP CONGA SHAKER TRIO

LP has added some variety to its most convenient and popular shakers. Three different fill options for a variety of dynamic levels. White shaker has the softest sound, great for studio applications. Blue shaker produces a multi-functional medium volume. Red shaker has the loudest and most coarse sound, great for live performances. Filled with non-toxic steel shot.

**LP017** Conga Shaker Trio,  
 Set of 3 .....\$16.00



## ANIMAL SHAKERS

Great sounding, brightly colored novelty shakers in three "favorite" animal shapes: elephant, giraffe, and rhino.

**LPR073BD30** 30 Pcs. Asst.....\$111.00  
**LPR4721** 3 Pcs.....\$17.00



## ONE HANDED TRIANGLE

Play Triangle rhythms using only one hand including rolls.

**LP311H**.....\$57.00



## LP FOOT TAMBOURINE

Durable red, high-impact plastic frame. Patented jingle pinning system keeps jingles in place. 4 pairs of Nickel plated steel jingles for bright, high-projecting sound. Elastic band fits comfortably over foot. Ideal for cajon and guitar players.

**LP188**.....\$20.00



## ANKLE BELLS

Dancers can contribute a jingle sound to the music.

**MIDANC3** 25 Bells .....\$27.90B  
**MIDANC5** 50 Bells .....\$55.90B



Matt Sorum's pack contains a tambourine, cowbell, jam block and a Mini Everything Rack.

**1208MS**.....\$215.00



## PERCUSSION TABLES

**LP760A**.....\$487.00  
**DS800B** Hercules Percussion Table Stand, 48"H x 24"W x 19"L.....\$149.95

## TRAP TABLE

**LPA521** .....\$204.00  
**LLE1378** w/Stand.....\$235.20  
**LLE1368** Stand .....\$120.50  
**RT7500** Tray.....\$68.95  
**RT7501** RT7500 Extender.....\$26.95



## MANHASSET

The new **Manhasset® Drummer Stand** is designed specifically for the drummer and percussionist. It is extremely portable with a full desk and 16" chrome shaft that attaches via a multi-angle, multi-clamp to all varieties of drumset tom mount hardware, also attaches easily to other devices like microphone stands.

**M53D** .....\$92.43  
**HI-HAT DRUMMER STAND**  
**M53DH**.....\$102.55



## VIBRA TONE

Tubular instrument delivers bell-like tones.

**LP775** Standard.....\$63.00



## KOKIRIKO

Crisp, tight sound.

**LP437**.....\$45.00



## CRICKET

Emulates the sound of a cricket.

**LP634**.....\$63.00



## SHAKERS

**Salt & Pepper Shakers**

**TSPSA** Green & Yellow.....\$22.00B



## SPINNING DRUM

Twisting rapidly in your hand causes both beads to strike heads creating a loud "party sound."

**B35**.....\$4.95



## MIKE PORTNOY PERCUSSION KIT

Tambourine, Rock Ridge Rider Cowbell & Mount All Bracket.

**008MP**.....\$141.00

## COWBELL HOLDER



Mounts on base drum hoop. Heavy steel construction.

SC268R .....	\$15.30
UPCBH .....	30.00
LP338 .....	25.00
UPUC U clamp .....	8.00
DAN310 .....	34.50
DAN310A with 12" post .....	40.50
LP328 with Sliding Post .....	74.00

## COWBELL HOLDER



Designed to hold bell firmly on field drum, Timbale or toms. Connects with tension rod through top plate and clamps around lug.

UPCBHR .....	\$26.90
DAN510 .....	39.00
LP397 .....	31.00
DAN500 U clamp .....	9.00
RT7903 Sideman .....	20.95

## COMBINATION HOLDER



Wood block and cowbell holder combination. Holds any sized wood block and cowbell. Attaches to bass drum hoops.

DAN924 Danmar .....	\$38.25
SCR269 Gibraltar .....	19.80

## COWBELL HOLDER



Connects firmly to any size stand or rod. Will hold two bells. Heavy duty "U" clamp included. Chrome plated steel.

DAN307 .....	\$38.75
DAN307A with 12" post .....	44.70
UPCBHS .....	29.00
LP236C Mount All .....	48.00

## WOOD BLOCK HOLDER



Adjustable to hold all blocks. Fits any 3/8" rod on set or stand.

DAN201 .....	\$38.85
UPWBH .....	26.00

## WOOD BLOCK HOLDER



Attaches to hoop. Holds any sized wood block.

DAN929 Danmar .....	\$36.90
LP373 Fits LP woodblocks .....	25.00

## WOOD BLOCKS



LPA210 Small, w/ Beater .....	\$20.00
LPA211 Large, w/ Beater .....	24.00
DAN411A 7 1/2" Maple .....	23.25
DAN411 6 1/2" Maple .....	20.25
T23M 6 1/2" Select Wood .....	21.00
T23AM 7" Select Wood .....	23.05
MIDBLCKR3 Mideast Rosewood Blocks, Set of 3 w/Beater .....	39.90B



<b>BLACK SWAMP MAPLE WOOD</b>	
BSMWB0 X Large .....	\$60.00*
BSMWB1 Large .....	57.00*
BSMWB2 Medium .....	54.00*
BSMWB3 Small .....	52.00*
<b>RHYTHM TECH</b>	
RT8410S Small .....	\$43.95
RT8410M Medium .....	46.95
RT8410L Large .....	50.95

## COWBELLS



### REMO ACOUSTI-BLOX

Equipped with a tubular mallet. Finish: Dark Green.  
AB8500CB 8.5" x 5 5/8" ..21.25

### CANNON

UPCB4 4" .....	\$13.20
UPCB5 5" .....	15.85
UPCB6 6" .....	15.00
UPCB7 7" .....	19.00
UPCB8 8" .....	20.50
UPCB9 9" .....	23.00

### DANMAR

#### Black Enamel

DAN915 4 1/2" .....	\$25.50
DAN916 6" .....	28.50
DAN917 10" .....	37.50

### DUPLEX

#### Copper

3082 4 1/2" .....	\$19.00
3083 5 1/2" .....	19.95
3084 5 3/4" .....	22.00

### MEGA

#### Black Wrinkle Finish

UPCS 5 1/2" .....	\$21.95
UPC7 7 1/2" .....	23.95
UPC9 9 1/2" .....	25.95

### RHYTHM TECH

RT3005 5" Black Studio .....	\$34.95
RT3008 8" Black Studio .....	43.95
RT3205 Legacy 5" .....	52.95
RT3206 Legacy 6" .....	56.95
RT3207 Legacy 7" .....	60.95
RT3208 Legacy 8" .....	63.95

### ASPIRE SATIN BLACK

LPA402 4 3/8" Agudo .....	\$36.00
LPA404 5 3/4" Cha Cha .....	38.00
LPA404HK 5 3/4" Cha Cha Hand Held w/Beater .....	47.00
LPA406 6 3/8" Timbale .....	42.00
LPA408 8" Rock .....	46.00
LPA408H 8" Handheld Bongo .....	46.00
LPA410 9 1/2" Grande .....	50.00

### BEATER

LP207 Cowbell Beater .....	\$14.00
----------------------------	---------



### GROVER PRO ROCK MAPLE

WB7 7" .....	\$49.00*
WB8 8" .....	51.00*
WB9 9" .....	53.00*
WB10 10" .....	55.00*

(\* = Call for pricing)

# ETHNIC PERCUSSION



### WAH SHAKER

Place both palms over ends and shake. Vary sound by cupping and lifting hands at shaker end.

**LP351**.....\$28.00



### WOODPECKER

Produces a sharp projecting rapping knocking sound.

**LPR080**.....\$19.00



### LP JINGLE QUBE

Flat and dimpled brass jingles create multiple sound combinations. Play front to back, side to side, and in a circular motion for a double time feel. Compact, durable construction.

**LP460J**.....\$58.00



### SHAKER

**LP459** Vari Tone .....\$26.00



### BOX SHAKERS

Great sounding, brightly colored shakers in three sizes for low, medium, and high pitches.

**LPR070** Set of 3 .....\$12.00



### ONE SHOT SHAKERS

Anodized Metal  
**LP442A** Small.....\$47.00 pr.



### MULTI SOUND INSTRUMENT

Combines the sound of a tambourine and clave into a single instrument.

**LPPER007**.....\$73.00



### PRO SHEKERE

Delivers crisp, tight shaker sounds.  
**LP483**.....\$217.00



### SHEKERE

Gourd style  
**MIDSHKM**.....\$39.90B



### SHAKERS

**RT2035** Cocktail.....\$32.95  
**RT2015** 5" Studio Shaker .....16.95  
**RT2019** 9" Studio Shaker .....19.95  
**RT2030** Live Shaker Red .....32.95  
**RT2040** Live Shaker Blue .....32.95



### LP HI-HAT SHEKERE

Designed with LP artist and educator Michael Spiro. Includes Fiberglass Shekere with mounting bracket; connects to Hi-Hat rod. Special light-weight netting provides easy movement of beads on shell. Large beads made from special materials provide a more natural sound. Includes three extra Hi-Hat seat washers, Shekere does not bottom out on seat. **Note: Hi-Hat stand not included.**  
**LP485** .....\$199.00



### CANZ

Distinctive Sounding Shakers  
**RTCNG** Zesty Green .....\$7.95  
**RTCNB** Smokey Blue .....7.95  
**RTCNR** Hot Salsa Red .....7.95

## STONE DRUMS



- AC34 4 Tone Maple top .....\$143.40B  
 AC36 6 Tone Maple .....155.40B  
 AC38 8 Tone Cherry .....170.40B

## WASHBOARD



Great sound effects for school music and country bands. Includes 3 thimbles.  
 FN75 .....\$32.55

## MUSICAL SPOONS



- 3470 .....\$10.00

## RHYTHM BONES (HARD WOOD)

- RSB2 Session Bones .....\$29.95B/1 pr.



- RHYTHM TECH  
 RT8400 Chatter Box .....\$48.95

## SLEIGH BELLS



- 3567 13 Bells on handle .....\$45.00  
 3568 25 Bells on handle .....\$59.55

### COSMIC PERCUSSION

- CP374 25 Bells .....\$63.00  
 CP373 12 Bells .....\$39.00

### CANNON

- UPS1B 25 Bells .....\$49.50  
 BH13M 13 Bells .....\$46.00

### CANNON ROW BELLS

- BL5M 5 Bells .....\$19.00  
 BL9M 9 Bells .....\$25.00

## PAN PIPES (FLUTES)



1 1/2 octave range, 12 1/4" x 6 1/4" curved, 13 canes in graduated lengths.

- QT20 .....\$14.10

3 octave range, 17 1/4" x 12" curved, 23 canes in graduated lengths.

- QT21 .....\$28.30

3 octave range, 17 3/4" x 7" flat, 23 canes in graduated lengths of two adjacent rows.

- QT22 .....\$28.30

## ACME WHISTLES



- TH144 Large Two Tone Whistle .....\$32.15  
 TH281 Quail .....54.65  
 TH446 Cuckoo .....35.20  
 TH500 Pigeon, Dove .....42.40  
 TH259 Crow Call .....12.60  
 TH12NP Bosun Whistle .....42.85  
 TH499 Nightingale Water Whistle .....56.60  
 TH6012NP Thunderer Whistle, Sm. ....12.75  
 TH5912NP Thunderer Whistle, Lge. ....14.30  
 TH147NP Siren Whistle .....68.50  
 TH572 Duck Call .....25.00  
 TH536 Tugboat Whistle .....64.40  
 TH534 Train Whistle .....141.05  
 TH451 Siren Horn .....137.90  
 TH15 Metropolitan Whistle .....20.15  
 TH472 Slide Whistle, plastic .....56.85  
 TH635 Tornado .....8.25  
 THT2000BK Referee .....7.85  
 TH475 Mardi Gras .....11.05  
 4218 Train Whistle, Wood .....7.15B  
 302 American Slide Whistle, metal .....23.60  
 W10 Slide Whistle, metal .....22.95  
 LP352 Samba Whistle .....52.00  
 LPA229 Samba, Plastic .....6.99  
 W100W White Lanyard .....2.10  
 S671 Black Lanyard .....2.10

## INSTRUMENTS OF THE ANDES



10715



10729



10759



10799P



10780



10761

- 10759 Ocarina, Lge. Losa .....\$12.75  
 10761 Ocarina, Smooth .....6.00  
 10715 Ocarina, Madrechí .....14.25  
 10718 Ocarina, Madregra .....17.25  
 10719 Panpipe, Antara, 7 Note .....9.75  
 10713 Panpipe, Antara, 12 Note .....15.75  
 10710 Small Pan Pipe, 7 Note .....9.75  
 10765 Double Rattle Drum .....19.50  
 10780 Leaf Shaker .....10.50  
 10707S Small Bamboo Flute .....6.75

- 10707L Large Painted Bamboo Flute .....\$8.25  
 10707D Double Flute Bamboo .....9.00  
 10729 Zampona, Large, 13 Note .....30.00  
 10712 Flute, Wooden Med. ....19.50  
 10763 Andean Drum .....30.00  
 10798DL Guiro Huiro - Large .....40.50  
 10720 Flute, Large, Wooden .....25.50  
 10766R Small Rattle Drum .....10.50  
 10799P Colored Maracas .....28.50

## DIDGERIDOOS



### BAMBOO DIDGERIDOOS

Hand crafted and hand painted. 47" long with wax mouth piece. Carry bag included.

- DIDGPT Turtle .....44.10  
 DIDGPK Kangaroo .....44.10  
 DIDGPG Gecko .....44.10

### DURO DIDGERIDOOS

Lightweight synthetic construction. Extremely durable.

- DIDGDUROSM 48" .....42.30  
 DIDGDUROLG 51" .....45.90

Injection Molded Assorted Patterns

- MIDDPABN .....\$27.90B

## BULB HORN



- MIDBULB .....\$23.90B  
 MIDBULB Bulb Only .....7.90B

WE STOCK PRINT MUSIC AND VIDEOS FOR PERCUSSION



# ETHNIC PERCUSSION



## SCRATCHER

- 117P Guiro.....\$16.35
- CP249 Cylinder Wood.....31.00
- CP249A Fish Style.....31.00
- LP334 Scraper, Metal.....7.00
- UPWG Wood Guiro .....22.90



## MERENGUE GÜIRA

One of the driving forces in a Merengue Band.

- LP305.....\$146.00



## GUIROS

- LP243 Super .....\$67.00
- LP245 Puerto Rican, includes scraper & draw-string bag .....59.99
- LP249 Cuban w/Scraper .....94.00
- LP334 Scratcher, Metal .....7.00



## RAINMAKERS

- TRAIN24 Bamboo, 24" .....\$31.20
- TRAIN39 Bamboo, 39" .....39.00
- TRAIN39S Duro-Santa Fe (Plastic) .....39.00
- LP455A Large Bamboo.....107.00
- LP456A Crystal, 18" .....57.00
- LP456M Mahogany, 24" .....121.00



## CLAVES

- 4963 Hardwood .....\$4.95 pr.
- T2512 Rosewood, Toca.....21.00
- DAN935 Rosewood .....20.30
- GRCLT Composite Low.....20.00
- GRCMT Composite Med.....20.00
- GRCHT Composite Hi.....20.00



## CLAVES

- LP211R Standard.....\$48.00
- LP212R African .....59.00
- LP597 Fiberglass (King).....41.00
- LP262 Traditional .....19.00
- LP262R Hardwood .....32.00



## SCRATCHER

- Zydeco Tie
- ZTIE with Thimbles .....\$28.75



## SLAPSTICK

- DAN412 .....\$45.00
- 3465 .....29.95

## GROVER PRO PERCUSSION



### LARGE GRANADILLO CASTANETS (PRO CONCERT)

Invisible tension adjustment system, unobtrusive micro-adjustable knob, out of the way of grip area, durable spring-steel tensioning mechanism (not elastic), solid granadillo clappers – uni-block construction, comfortable "timpani stick" style handle, free protective covers and case.

- GWC3G.....\$209.00\*

\*CALL FOR DEALER COST



## CASTANETS

- LPA131 Dble Hand Held .....\$22.00
- LPA132 Single w/handle .....19.00
- TH609 Set .....29.70
- TS30WAM Pair, Rosewood .....19.00

## BLACK SWAMP PERCUSSION



### CONCERT CASTANETS

- BSPCC3RW Large Bloodwood Castanets on handles, pair .....\$178.00\*
- BSCMF Castanet Mounting Frame (machine only) .....132.00

\*CALL FOR DEALER COST\*



## CASTANETS

Three models of castanets are offered to meet every percussionists' needs. Each set is precisely made from kiln dried Rosewood or Ebony

- LP430 Single w/handle.....\$41.00
- LP431 Rosewood Double w/handle .....48.00
- LP432 Ebony Double hand held .....46.00



## THUMB PIANO

- MIDTHMP Large.....\$43.90B
- MIDTHMS Small.....32.90B



## PRO RATCHETS

- 4876 .....\$39.70
- LLE75 Ludwig.....61.95B



## CABASA

- RT8000 Cabasa.....\$49.95
- RT8002 Piccolo Cabasa .....33.95
- RT8003 Cabasa, Mounted .....50.95



Castanets mounted on walnut finish base.

- V800 Vic Firth.....\$46.00
- DAN17A .....85.50

Designed to be mounted on drum set or stand.

- DAN16B .....\$85.50

### LP CASTANET MACHINE

Hassle free o-ring tension system. Can be mounted on a 3/8" rod. Mount can also be removed for table-top playing.

- LP427 .....\$44.00

# ETHNIC PERCUSSION BONGOS/CONGA



**BONGOS TUNABLE**  
**BONGO2** .....\$70.00



**KIDS CONGA**  
 Great sounding kid-sized conga with carry strap.  
**LPR321** .....\$45.00



**Remo Valencia Bongos** are the choice for many top Salsa musicians.

Bongo Set, 7"/8.5" Diameters, Valencia, Curved Hoops, Skyndee Calf Tucked Heads, Salsa Deco  
**BG782136** .....\$530.20B

Bongo Set, 7"/8.5" Diameters, Valencia, Curved Hoops, Skyndee Calf Tucked Heads, Palmilla  
**BG782137** .....\$530.20B



**BONGOS TUNABLE**  
**W460 6" X 7"** .....\$69.50



**BONGOS**  
 A very well made bongo with 6" and 7" real skin heads.  
**W450 PreTuned** .....\$49.50



## REMO

**BONGOS**  
**BG5300XX** .....\$71.00  
 (52) Red, (70) Black, (00) White



**BONGOS**  
 Tunable  
**CP221AW** Natural Color .....\$85.00  
**CP221DW** Dark Wood .....85.00  
**CP221A** Small Head 6" .....27.00  
**CP221B** Large Head 7" .....29.00



**MINI BONGOS**  
 Tunable, wood, 4" high and 10" wide.  
**LPM199AW** Bongos .....\$66.00  
**LPM910** Small Head 3 1/2" .....9.00  
**LPM911** Large Head 4 1/4" .....14.00



**BONGO TUNABLE**  
**UPWB2** .....\$85.50



**WOOD TUNABLE BONGOS**  
**M201AWC** Natural/Chrome .....\$247.00  
**M201AW** Natural/Gold .....247.00  
**M201BKWC** Black/Chrome .....247.00  
**M263A** Small Head 7 1/4" .....60.00  
**M263B** Large Head 8 3/8" .....63.00



**TUNABLE FIBERGLASS BONGOS**  
**3600SPBK** .....\$86.40  
**43607** 7" Head .....12.60  
**43608** 8" Head .....12.60  
**UPWB2S** Small Head 6" .....9.95  
**UPWB2L** Large Head 7" .....9.95



**BONGOS**  
**100DX** Deluxe .....\$52.65  
**100ST** Standard .....47.35  
**100JR** Junior .....43.90

www.lpmusic.com

# ETHNIC PERCUSSION



## BONGOS

Exceptional quality, non-tunable bongos have real skin heads for authentic sound. (7" x 5")  
**B370** (R) Red, (B) Blue.....\$25.00



## BONGOS

**LPA601XX**.....\$172.00  
**HEADS**  
**LPA663A** 6¾" for LPA601 .....\$42.00  
**LPA663B** 8" for LPA601 .....\$47.00  
 Specify:  
 AW- Natural, DW- Dark, RW- Red Wood



## BONGOS

Fiberglass drums with black finish.  
**LP200XFBK**.....\$438.00  
**ASPIRE**  
**LPA601FRD**.....\$172.00  
**LPA601FBK**.....\$172.00



## BONGOS

Natural finish wood with gold tone hardware.  
**LP201AX2AW** .....\$439.00  
**LP201AX2DW** Dark Wood.....\$439.00



## HAND DRUM

Super-thin 10" hand drum provides an exceptionally loud, clear sound. Assorted colors, includes mallet.  
**B360A** .....\$15.50



## RATTLE DRUM

Solid wood body. Two beads attached with a strong cord strike both heads as you twist the drum in your hand. Squeezing the drum as you twist changes the pitch.  
**W420**.....\$19.50

## ASPIRE™ CAJON

The durable plywood front panel is adjustable with varying screw tension. Large rubber feet keep the cajon in place during play. Slam Oak sound board. Three sets of Internal Snare wires. Textured seating surface. 12"W x 11¾"D x 17¼"H.  
**LPA1331** Natural Finish .....\$215.00  
**LPA1332** Color.....\$246.00  
 Specify:  
 Sunburst (SBS), Dark Wood (DWS), Blue (BBS), White (WS)



LPA245

## BONGO STANDS

**LP330**.....\$244.00  
**HZBS** .....\$79.95  
**3815** .....\$69.50  
**M245** Deluxe .....\$192.00  
**LPA245** Strap Lock.....\$146.00  
**DAN315** Mounting bracket .....\$36.00  
**LPA244** Mounting bracket .....\$77.00



## FRAME DRUMS

Excellent quality frame drums. Includes wooden mallet.  
**W106** 6" .....\$8.55  
**W108** 8" .....\$9.55  
**W110** 10" .....\$12.55



## LP CAJON BAG

Durable, heavy padding for superior protection. Large external pocket and shoulder strap. Fits most standard cajons on the market.  
**LP524UT**.....\$89.00



## ASPIRE™ JUNIOR CAJON

This compact cajon features an adjustable panel. Slam Oak sound board. One set of internal Snare wires. Textured seating surface. 9¾"W x 9½"D x 15½" H.  
**LPA1330**.....\$174.00



## LP AMERICANA SERIES

**KEVIN RICARD SIGNATURE CAJON**  
 Constructed of hand-selected, 11-ply plantation grown, Baltic Birch Wood. Features our new and innovative patent pending top-tuning design. Beautiful Heartwood front plate. Angled top corners for playing comfort. Equipped with four independently tuned D-Addario guitar strings. 11¾ W x 11¾" D x 19"H.  
**LP1424** .....\$599.99



## BODHRANS

Wood cross bracing provides stability and an easy grip. Includes wooden mallet.  
**W414** 14" .....\$52.50  
**W416** 16" .....\$55.50  
**W418** 18" .....\$58.05



## BODHRANS

**MIDBTN8R** 18" Rosewood Tunable.....\$101.90B  
**MIDBSSB** Tipper.....\$4.90B  
**MIDGT22** Goatskin Head Only .....\$22.90B



## BODHRANS

**MIDBTGR** 18" Rosewood .....\$85.90B  
**MIDBTGR** 18" Drum .....\$99.90B



## BODHRANS

**SATB2** Dark Green, 18" .....\$57.70  
**SATB3** Dark Brown, 18" .....\$57.70  
**SC5010** Bag .....\$39.85  
**SBT001** Tipper .....\$5.20



## LP CAJON THRONE

**LP1445** 10" x 2" .....\$29.99

## LP CAJON PEDAL

**LP1500** .....\$249.99



## LP ULTRA-TEK BONGO BAG

Durable, heavy padding. Oversized w/interior pockets. Shoulder strap included.  
**LP533UT** .....\$139.00



## RHYTHM TECH

### ECLIPSE CAJON

The Rhythm Tech Eclipse Cajon features a set of wire snares for a tighter top end slap while retaining deep bass notes. The strong plywood front panel is tunable by changing the screw tension and a textured seating surface and large rubber feet keep it secure and comfortable. Dimensions: 18.5"H x 11.5"W x 12"D. Carton weight: 10 lbs.  
**RT5700** Natural Finish .....\$189.95

# ETHNIC PERCUSSION



## ASPIRE WOOD CITY SERIES CONGAS SET

Natural wood 10" & 11" congas, 28" tall with double conga stand. Black powder coated hardware.

**LPA646NY** .....\$499.99

AW - Natural, DW - Dark, CMW - Carved Mangowood, VSB - Vintage Sunburn Satin



## CONGAS

Classic model, 30" tall, natural finish with gold tone hardware.

**LP522XAW** 11" .....\$699.00



## ASPIRE CONGAS

Classic model, 28" tall, with black hardware.

**LPA610** 10" .....\$271.00

**LPA611** 11" .....\$283.00

**LPA612** 12" .....\$295.00

Specify:

AW - Natural, DW - Dark



## CONGAS

Galaxy Giovanni series. 30" tall, American ash, gold tone hardware.

**LP806ZAW** 11 3/4" .....\$986.00

**LP807ZAW** 12 1/2" .....\$997.00



## ASPIRE WOOD CONGA SETS

Natural wood set of 10" & 11" congas with double stand.

**LPA646AW** .....\$649.00

**LPA646DW** .....\$649.00

11" Conga and 12" Tumba Set with Double Stand

**LPA646BAW** .....\$649.00

**LPA647AW** .....\$659.00

**LPA647DW** .....\$659.00

AW - Natural, DW - Dark



## LP RICHIE GAJATE-GARCIA SIGNATURE SERIES CONGA

30" tall, 3-ply, Romanian Tilia wood with fiberglass layer on the inside, upper portion of the shell for added strength. Natural rawhide heads and Mavi satin finish. Decorative bands lathed around the shells. Features modified & patented, Chrome-plated Top Tuning Comfort Curve® II, steel rims.

**LP559TRGM** .....\$739.00



9" x 20" Rosewood Ashiko

**MIDASKS** .....\$159.90B



## SANTANA MINI CONGA/BONGOS

4 1/2" x 11"

**LPM197IW** Conga .....\$92.00

**LPM197SNB** Black .....\$92.00

**LPM197SNW** White .....\$92.00

**LPM200AW** Bongo, 4 x 10" .....\$80.00



**ET500517** Mini, 5 Piece Set, Rainbow .....\$175.40



## LP WORLD BEAT® CARIBE CONGA

**WB2040** Natural .....\$210.00

21" Siam Oak shells, natural rawhide head, EZ curve rims, black powder-coated hardware.



**LP278**

## CONGA STANDS

Height adjustable with removable legs.

**LP278** .....\$259.00

**LPA650** Basket .....\$92.00

**LP290B** Double w/wheels .....\$345.00

**LPA653** Double, Slide Mount..\$174.00



## CONGA/BONGO HEADS ACCESSORIES

**LP265A** 11" Conga Head.....\$101.00

**LP265B** 11 3/4" Conga Head.....\$109.00

**LP265C** 12 1/2" Conga Head.....\$115.00

**LP263A** 7 1/4" Bongo Head .....\$68.00

**LP264A** 8 3/4" Bongo Head .....\$71.00

**LP215B** Conga Lug.....\$16.00

**LP637** Conga Feet.....\$33.00

**LP4A26B** Mounting Bracket .....\$16.00



## RAWHIDE CONGA HEADS

**LPA640A** 10" .....\$70.00

**LPA640B** 11" .....\$78.00

**LPA640C** 12" .....\$83.00



## CONGA HEADS

**CP265A** 10" .....\$72.00

**CP265B** 11" .....\$80.00

**CP636A** 9" Conga .....\$35.00

**CP636B** 10" Conga .....\$37.00



## CONGA BAGS

**LP541BK** Pro, fits all.....\$180.00

**LP546BK** w/Wheels.....\$208.00

**LP546UT** Ultra-Tek, Fits All.....\$219.00

**LP543BK** .....\$128.00

www.lpmusic.com

# ETHNIC PERCUSSION



**MINI DJEMBE**  
5 1/2" X 8 1/4", Tunable  
LPM196AW Small .....\$80.00



**DJEMBES**  
25" Tall, 12 1/2" Head  
LPA630AWC Natural .....\$302.00  
LPA630DWC Dark.....\$302.00  
LPA630RWC Red .....\$302.00  
LPA630A 12 1/2" Head.....\$83.00



**DJEMBE**  
12 1/2" x 25" natural finish drum with chrome hardware.  
LP720X .....\$648.00



**DJEMBE**  
Exotic Jamjuree (Siam Walnut) wood. Finished in a satin, matte lacquer. 12 1/2" goatskin head, 2-ply, 25" tall shell with EZ-Curve rim. Black powder coated hardware.  
LPA632SW .....\$319.00



**DOUMBEK**  
10" x 15" Metal Dumbek  
MIDMD10 .....\$149.90B  
MIDMD08S 8" x 14" Metal Dumbek w/Synthetic Head.....\$89.90B



MIDMD10S 10" x 15" Metal Dumbek w/Synthetic Head.....\$119.90B

**DOUMBEKS**  
Brightly plated steel with beautiful engraving. Tunable  
W508 8" Chrome .....\$95.05  
W510 10" Chrome .....\$99.55  
W508B 8" Brass.....\$95.05  
W510B 10" Brass.....\$99.55



**DJEMBE / BONGO STANDS**  
LP729 Djembe.....\$146.00  
Camlock bongo stand.  
LP330 .....\$244.00



**DJEMBE BAG**  
Padded back with adjustable backpack straps  
LP547BK .....\$130.00



**ASHIKO**  
9" x 20" Rosewood Ashiko  
MIDASKS .....\$159.90B  
MIDAKB2 Tunable, 12" x 24" \$199.90B  
MIDSHBG 12" Goatskin Head..\$79.90B



**HUDAK**  
17" Talking Drum  
MIDHUDX .....\$69.90B



**HUDAK**  
9" Indian Talking Drum  
MIDHUDK .....\$79.90B



**TALKING DRUMS**  
Played by holding under your armpit, squeezing the cords alters the pitch  
W710 Chrome .....\$99.55  
W710B Brass.....\$99.55



**DOUMBEK**  
10" x 15" Ceramic Dumbek  
MIDCDNMBFB.....\$99.90B



**LP UDU DRUMS**  
LP1400C1 Claytone #1.....\$109.00  
LP1400C2 Claytone #2.....\$121.00  
LP1400C3 Claytone #3.....\$145.00  
LP1400C4 Claytone #4.....\$185.00  
LP1400HG Hadgini.....\$185.00  
LP1400TM Tambuta.....\$159.00  
LP1400MB Mbwata.....\$171.00  
LP1400UT Utar.....\$171.00



**DJEMBE**  
10" x 20" Rosewood Djembe  
MIDDJMS .....\$159.90B  
12" x 22"  
MIDDJB2 Tunable .....\$305.00B



**TABLA SET**  
Standard tabla set with aluminum doogi.  
MIDTBSS Tabla w/bag .....\$269.00B

# REMO WORLD PERCUSSION



## DJEMBE

Leon Mobley, Key Tuned, Adrinkra Fabric

<b>DJ001224</b>	12" x 24".....	<b>\$357.30</b>
<b>DJ001424</b>	14" x 25".....	<b>426.80</b>



## DJEMBE

Superb Sound Quality and Lightweight Design.

<b>DJ0010XX</b>	24" x 10".....	<b>\$305.30</b>
<b>DJ0012XX</b>	24" x 12".....	<b>357.30</b>
<b>DJ0014XX</b>	25" x 14".....	<b>406.90</b>
<b>DJ0016XX</b>	27" x 16".....	<b>471.20</b>
<b>DJ0018XX</b>	28" x 18".....	<b>599.00</b>

XX = Specify  
(05) Earth, (LM) Multi Mask, (24) Adrinka,  
(BE) Black Earth, (30) Flame, (32) Green Kinte



## DJEMBE

<b>DJ0010PM</b>	24" x 10".....	<b>\$305.30</b>
<b>DJ0012PM</b>	24" x 12".....	<b>357.30</b>
<b>DJ0014PM</b>	25" x 14".....	<b>406.90</b>
<b>DJ0016PM</b>	27" x 16".....	<b>471.20</b>
<b>DJ0018PM</b>	28" x 18".....	<b>599.00</b>
<b>HK300870</b>	Claw Only.....	<b>3.10</b>

(PM) Kinte Kloth



## APEX DJEMBE

Skyndeeep® Fiberskyn® beige head, apex, key-tuned, green kinte.

<b>DJ611232</b>	12" x 22".....	<b>\$311.90</b>
-----------------	----------------	-----------------



## APEX DJEMBE

Skyndeeep® drumhead, key-tuned..

<b>DJ601270</b>	12" x 22".....	<b>\$284.10</b>
-----------------	----------------	-----------------



## KEY-TUNED DJÉMBES

Black Earth

<b>DJ0012BE</b>	12" x 24".....	<b>\$357.30</b>
<b>DJ0014BE</b>	14" x 25".....	<b>406.90</b>
<b>DJ0016BE</b>	16" x 27".....	<b>471.20</b>

## REMO CAJON

The Mondo™ Cajon is manufactured in Spain by the leading craftsmen in the industry and is designed to create the most sophisticated snare effects and has six adjustable coiled steel wires for powerful bass and slap tones, reinforced 11 3/8" x 11 5/8" x 18 1/2" structure, certified, FSC, CARB, birch plywood.



<b>CJ612900</b>	Mondo Cajon with Texture Targets, 1 Circle & 4 Curved Targets....	<b>\$450.00</b>
-----------------	---	-----------------

## Removable Adhesive Backed

<b>HK850000</b>	Textured Targets, 9.75 Circle & 4 small curves, S.....	<b>26.40</b>
<b>HK850100</b>	Textured Targets, 9.25 Square & 4 small triangles.....	<b>25.20</b>



## DOUMBEKS (SOLOIST)

Metalized Finish, Internal Tuning

<b>DK30084M</b>	8" Dia., Yellow.....	<b>\$396.75</b>
<b>DK30095M</b>	9" Dia., Orange.....	<b>414.00</b>
<b>DK30107M</b>	10" Dia., Turquoise.....	<b>430.75</b>



## DOUMBEK

<b>DK0410XX</b>	Pretuned, 16" x 10".....	<b>\$157.00</b>
-----------------	--------------------------	-----------------

(02) Night Fantasy, (08) Ceramic,  
(03) Gold Warrior



## TUBANO

<b>TU051009</b>	26" x 10" Pretuned.....	<b>\$214.75</b>
<b>TU051209</b>	26" x 12" Pretuned.....	<b>240.75</b>
<b>TU051409</b>	26" x 14" Pretuned.....	<b>278.50</b>



## ADVENT DJEMBE

Suede® drumhead, key-tuned..

<b>DJ101070</b>	10" x 20".....	<b>\$167.00</b>
-----------------	----------------	-----------------

[www.remo.com](http://www.remo.com)



## BAHIA BASS DRUM

<b>BH0012</b>	12" x 21".....	<b>\$351.60</b>
<b>BH0014</b>	14" x 21".....	<b>314.00</b>

Specify: (A1) Gypsy Red, (BE) Black Earth

# REMO WORLD PERCUSSION



## FRANCIS AWE TALKING DRUMS

Finishes: West African Stripe

- TD081618** 16" x 8", Iyailu .....\$418.30
- TD081818** 18" x 8", Ejin.....455.40
- TD101570** Mallet.....29.30



## FLAT GUIRO

- HK855000** Flat Guiro, 9.25" x 9.25", with plastic beater.....\$44.10



## VELEZ MONDO TARS

- ET8212GV** 2 1/2" x 12" .....\$56.25
- ET8214GV** 2 1/2" x 14" .....60.50
- ET8216GV** 2 1/2" x 16" .....74.75



## HULL ROPE TENSION ASHIKOS

Finish: West African Stripe (AH).

- AK2410AH** 24" x 10".....\$402.50
- AK3014AH** 30" x 14".....609.50



## MONDO DJEMBE

Contour Tuning Brackets, for added comfort Skyndeeep® Natural Graphical Drumhead.

- DJ0014SD** 14" x 25", Serpentine Day..\$426.80



## MONDO DJEMBE

Contour Tuning Brackets, for added comfort Skyndeeep® Natural Graphical Drumhead.

- DJ001436** 14" x 25", Salsa Deco.....\$426.80



## INFINITY MONDO DJEMBE

Key-tuned contour brackets. Eco-Grain choco red, Skyndeeep natural, goat strip brown, head.

- DJ011421**.....\$473.00



## KEY-TUNED ASHIKA

Arthur Hull Signature Series with West African Finish.

- AK0012AH** 25" x 12".....\$499.70B



## DJEMBE/CONGA STANDS

- DY0360DM** 12-14" Djembe Stand .....\$357.00B
- DY0360DL** 16-18" Djembe Stand .....357.00B
- DI611000** Djembe.....54.70B



## KICK CONGA

- CG1116TG** Conga w/pedal, 16" x 11" ....\$719.00D



## TUBANITO

- TU341095** Key-Tuned, 10" Diameter 4.5" Height, Caldera Red .....\$235.00



## DJUN DJUN

Metalized Rope Tuned

## PAULO MATTOLI SERIES

- ET2418BZ** 18" x 24", Bronze .....\$613.00



## THUNDER TUBES

- SP0207TD** 2 1/2" x 7" Tie Dye .....\$13.80
- SP0207TL** 2 1/2" x 7" Stormy .....12.60
- SP0606TD** 6" x 6" Tie Dye.....36.50
- SP0606TL** 6" x 6" Stormy .....36.50

www.remo.com

# REMO WORLD PERCUSSION



## RHYTHM CLUB

<b>RH1206</b>	Konga 12" x 6" .....	<b>\$44.70</b>
<b>RH5010</b>	Floor Tom 5" x 10" .....	<b>44.70</b>
<b>RH5600</b>	Bongo 4.5" x 5"/6" .....	<b>40.60</b>
<b>RH2106</b>	Tamborine 1.75" x 6.5" .....	<b>24.75</b>



## DOUMBEK

Pretuned, High Pitch, Fabric		
<b>DK0410XX</b>	16" x 10", Diane .....	<b>\$157.00</b>
<b>DK0408XX</b>	15" x 8", Diane .....	<b>132.25</b>
Specify Finish: (02) Night Fantasy, (03) Goldwarrior, (08) Ceramic, (05) White		



## TUNABLE TUBANO

NuSkyn Drumhead		
<b>TU1110XX</b>	27"x10" .....	<b>\$317.50</b>
<b>TU1112XX</b>	27"x12" .....	<b>357.00</b>
<b>TU1114XX</b>	27"x14" .....	<b>427.50</b>

Available in 05, 07, 16, 17, LM & PM Finish



## VELEZ RIQ

<b>TA0309GV</b>	Velez Riq, 2.625" x 9" .....	<b>\$162.00</b>
<b>TA1309GV</b>	Velez Riq, Tunable .....	<b>162.00</b>



## FESTIVAL TUBANOS

<b>TUFESMXX</b>	Tubano, small, 15" x 6" .....	<b>\$98.00</b>
<b>TUFEMDXX</b>	Tubano, med, 17" x 8" .....	<b>110.50</b>
<b>TUFELGXX</b>	Tubano, large, 18" x 10" .....	<b>132.25</b>
(13) Twinings (16) Island (17) Rainbow		



## FESTIVAL DJEMBES

<b>DJFESMXX</b>	Djembe, small, 14" x 8" .....	<b>\$126.50</b>
<b>DJFEMDXX</b>	Djembe, med, 20" x 10" .....	<b>190.30</b>
<b>DJFELGXX</b>	Djembe, large, 22" x 12" .....	<b>241.00</b>
<b>PERCSBK</b>	Strap .....	<b>45.20</b>
(13) Twinings (16) Island (17) Rainbow		



## FINGER DRUMS

<b>FGSHRTXX</b>	Short, 2" x 5" .....	<b>\$28.50</b>
<b>FGMEDMXX</b>	Medium, 3" x 5" .....	<b>30.50</b>
CC = Cosmic		



## THUNDER TUBES

<b>SP0606TD</b>	6" x 6" Tie Dye .....	<b>\$36.50</b>
<b>SP0606TL</b>	6" x 6" Stormy .....	<b>36.50</b>



## FESTIVAL DJEMBES

<b>DJFESMXX</b>	Djembe, small, 14" x 8" .....	<b>\$130.50</b>
<b>DJFEMDXX</b>	Djembe, med, 20" x 10" .....	<b>197.70</b>
<b>DJFELGXX</b>	Djembe, large, 22" x 12" .....	<b>251.00</b>
<b>PERCSBK</b>	Strap .....	<b>45.20</b>

Green Kinte Klothe (32), Autumn (33),  
Red Forge (34)



PERCSBK

## PERCUSSION STRAPS

<b>504470</b>	Medium, 110" .....	<b>\$47.40</b>
<b>504570</b>	Large, 130" .....	<b>47.40</b>
<b>PERCSBK</b>	Neotech .....	<b>45.20</b>



## TRILOCK GURTU SPRING DRUMS

<b>SP04101A</b>	10" x 3.5", Medium Angle, Trilok Gurtu .....	<b>\$39.10</b>
<b>SP041009</b>	4" x 10", Angled On One End, Fabric Tropical Leaf .....	<b>39.10</b>
<b>SP050509</b>	5" x 5", Fabric Tropical Leaf .....	<b>45.20</b>
<b>SP050517</b>	5" x 5", Fabric Rainbow .....	<b>45.20</b>

**FAX & E-MAIL ORDERS  
FOR PRINTED MUSIC  
WILL GET AN EXTRA  
5% DISCOUNT**

**FAX:  
(708) 496-2130  
(888) 983-5537**

**E-MAIL:  
sales@harristeller.com**



# REMO WORLD PERCUSSION



**DJEMBE**  
Keytuned, 14" x 25", Designer  
**DJ001430** Flame .....\$426.80



**DOUMBEK**  
Pretuned, High Pitch, Fabric  
**DK0410XX** 16" x 10", Diane .....\$157.00  
**DK0408XX** 15" x 8", Diane .....132.25  
Specify Finish: (02) Night Fantasy,  
(03) Goldwarrior, (08) Ceramic, (05) White



**NSL TUBANO**  
**TUNT1016** Tall, 10"x25" w/cap  
& mallets .....\$183.75  
**TUNT1216** Tall, 12"x25" w/cap  
& mallets .....216.25  
**TUNT1416** Tall, 14"x25" w/cap  
& mallets .....238.00  
**HK1350NS** Mallets.....18.10 pr.



**DJEMBE**  
Paulo Mattioli, Rope Tuned, Floating Ring.  
**DJ513BZ** 13" x 25".....\$525.00



**CUICAS**  
**CU321010** Chrome .....\$243.40



**NSL TUBANO**  
**TTUNS1216** Small, 12" x 14" w/cap  
& mallets .....\$183.75  
**TUNS1416** Small, 14" x 14" w/cap  
& mallets .....205.25  
**VC001070** Volume cap, 10" .....15.25  
**VC001270** Volume cap, 12" .....15.25  
**VC001470** Volume cap, 14" .....15.25

## LYNN KLEINER SERIES



**BABIES MAKE MUSIC!**  
Kit includes: Baby Drum with Mallet, Baby Bell  
Stick, Maraca, Red Scarf, Baby Book.  
**LK1100B1** .....\$56.90  
**HD2005LK** Baby Drum w/Beater.....28.10  
**LK242600** Baby Bell Stick.....9.50



**KIDS MAKE MUSIC!**  
Kit includes: Tambourine, Rhythm Sticks, Maraca,  
Jingle Bells, Triangle. (Toddlers - 5 Years).  
**LK2100K1** .....\$61.30  
**LK242504** 4 Large Nickel Bells Belt.....6.00  
**LK242503** 8" Rhythm Sticks .....10.50 pr.



**KIDS MAKE MUSIC, TOO!**  
Kit includes: Hand Drum with Mallet, Tone Block,  
Finger Cymbals, Shaker Egg, Purple Scarf. (3 - 8  
Years).  
**LK3100K2** Without Video .....\$61.30  
**HD1508LK** Hand Drum w/Beater .....28.90



**PADDLE DRUMS**  
**PD101000** 10" .....\$71.75  
**PD101200** 12" .....82.75  
**PD281000** 8" & 10" Set.....119.25



**LK242510** Glockenspiel.....\$37.25  
**LK242601** Yellow Loop Handle  
Maraca .....4.50 ea.



**FLAT GUIRO**  
**HK855000** Flat Guiro, 9.25" x 9.25",  
with plastic beater.....\$44.10

www.remo.com

# REMO KIDS PERCUSSION



## BONGOS

Pretuned FiberSkyn® 2 heads — Rain Forest FabriFinish™  
**KD540001** 6.5" x 5" & 6.5" x 6".....\$66.60



## KONGA

9 Pretuned FiberSkyn 2 head, strap, Rain Forest FabriFinish™ covering  
**KD150601** 6.5" x 15".....\$80.10



## TUBANO™

Pretuned FiberSkyn 2 head, Rain Forest FabriFinish™ covering  
**KD001001** 22" x 10".....\$150.25



## FLOOR TOM

8" x 10" Floor Tom  
**KD508001**.....\$71.00



## DOUMBEK

10" x 6" Doumbek  
**KD030601**.....\$87.90



## DJEMBE

14" x 8" Djembe  
**KD060801**.....\$108.70

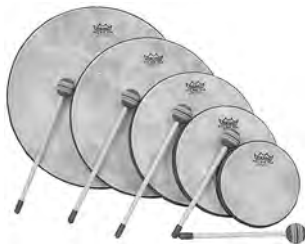

## HAND DRUMS

**KD010601** 1" x 6" Hand Drum.....\$25.25  
**KD010801** 1" x 8" Hand Drum.....28.50  
**KD011001** 1" x 10" Hand Drum .....31.00  
**KD011201** 1" x 12" Hand Drum .....36.00  
**KD011401** 1" x 14" Hand Drum .....43.10  
**KD050001** Set of 6", 8", 10", 12" and 14" Drums.....160.25  
**HK122508** Mallet (8" Handle).....6.30  
**HK122410** Mallet (10" Handle).....6.30  
**HK014070** Mallet, 40mm, Plastic Handle.....6.00



## LOLLIPOP DRUM

Paddle Drum with Old-Fashioned Lollipop graphic on the head, mallet included  
**ET711000** 1" x 10".....\$31.10  
**ET710800** 1" x 8".....27.90  
**ET710600** 1" x 6".....25.30



## FINGER DRUMS

**FGSHRTCC** Short, 2" x 5".....\$28.50  
**FGMEDMCC** Medium, 3" x 5".....30.50  
 CC = Cosmic



## GATHERING DRUMS

**KD581601** 8" x 16" Kid's 'Gathering Drum'.....\$124.20  
**KD581801** 8" x 18" Kid's 'Gathering Drum'.....141.60  
**KD582201** 8" x 22" Kid's 'Gathering Drum'.....180.40  
**KD522201** 21" x 22" Kid's 'Gathering Drum'.....271.75



## TROPHY THUNDER TUBES

**TT30TD** Tie Dye.....\$13.00  
**TT30SN** Starry Night.....13.00  
**TT30L** Lightning.....13.00  
**TT40BL** Big Lightning.....39.50

## REMO



### FRUIT SHAKES

SCAPLG	Apple.....	\$14.17
SCAVCD	Avocado.....	14.17
SCBANA	Banana.....	14.17
SCLEMN	Lemon.....	14.17
SCORNG	Orange.....	14.17
SCPEAR	Pear.....	14.17
SCPLUM	Plum.....	14.17
SCASRT07	Assortment.....	98.00



## RHYTHM TECH



### FRUIT SHAKERS

RT2051	Apple.....	\$9.95
RT2052	Banana.....	9.95
RT2053	Orange.....	9.95
RT2054	Pineapple.....	9.95
RT2055	Avocado.....	9.95
RT2056	Pear.....	9.95
RT2057	Lemon.....	9.95

### PERCUSSION SHAKERS

SR120620	Ginga 6" x 2 1/4".....	\$20.50
SR020626	Samba 6" x 2 1/4".....	14.25
SR241227	Digeharp 12" x 2 1/4".....	21.50
SR020418	Dove 4" x 2 1/4".....	10.75

## BAGPIPES/CHANTERS



MIDBAGAT	Mini size bagpipe, ideal for in-home use.....	\$219.90B
MIDBAGBT	1/2 Size bagpipe, engraved trim.....	229.90B
MIDBAGCT	Full size bagpipe, Sheesham, natural, aluminum mounts.....	239.90B
MIDBAGDT	Black version of MIDC.....	239.90B
MIDBAGET	Full size, Rosewood, engraved nickel silver mounts.....	279.90B
MIDBAGFT	Full size bagpipe, cocus, natural, imitation ivory mounts.....	279.90B
MIDBAGL	Practice Chanter, Rosewood.....	29.90B
MIDBAGLRB	Black Rosewood Practice Chanter w/Black Mouthpiece.....	27.90B
MIDBAGLRN	Rosewood Practice Chanter w/Black Mouthpiece.....	27.90B
MIDBAGLBC	Rosewood Practice Chanter Kit, Book and CD.....	49.90B
MIDBAGM	Practice Chanter, Cocus, nickel silver engraved sole.....	33.90B
W600	Child Size Bagpipe.....	59.50
MIDBACQ	Practice chanter reed, plastic.....	3.70B
MIDBATQF	Tenor drone reed, cane.....	4.30B
MIDBAQ	Pipe chanter reed, cane.....	4.30B
MIDBAGS	Seasoning.....	13.90B
MIDBABQF	Bass Drone Reed, Cane.....	4.30B

## PIXIE HARP



31 inch tall, Rosewood Pixie Harp with 19 Nylon Strings.

MIDHPXA	.....	\$339.00B
MIDHPXC	Case.....	109.90B
MIDHPXS	String Set.....	12.90B

## HEATHER HARP



22 Strings, approximately 36" high, featuring 22 DuPont hard nylon strings.

MIDHTHA	.....	\$449.00B
---------	-------	-----------

## BALALAIKA



27" x 16" Rosewood Balalaika with case  
MIDBLLP.....\$279.00B

## OUDE



Egyptian Mosaic Oud with Hard Case, 32" x 15", includes extra string set, oud pick. Made of rosewood.

MIDOUDI	.....	\$579.00B
---------	-------	-----------

## NOBLE & COOLEY



Marching Drums  
NC890 Wally Bear .....\$25.00

# REMO WORLD PERCUSSION



**SOUND SHAPES MINI SHAPE PACK**  
**SS300003** 3 Random Colored 7" Shapes:  
 Circle, Rectangle, Triangle.....\$59.00



**SOUND SHAPES CIRCLE PACK**  
**SS100005** 5 Random Colored Circle Shapes.  
 15", 12.75", 10.5", 8.25",  
 6" Circles.....\$120.50



**TAMBORIM**  
 Tunable, 6" diameter, Brilliantburs Clear Tone  
 drumhead, produces bright sharp tones.  
**TM72061G**.....\$64.10



**SOUND SHAPE™ BENDIR**  
 A single snare gives this drum its characteristic  
 buzzing sound, just like its North African cousin.  
**SS0712** 12".....\$26.50  
**SS0716** 16".....\$39.25



**SOUND SHAPE™ Cuica**  
 This Cuica is played much the same as the profes-  
 sional REMO® Cuica.  
**SS0009CU**.....\$36.75



**PADDLE DRUMS**  
**PD101000** 10".....\$71.75  
**PD101200** 12".....\$82.75  
**PD281000** 8" & 10" Set.....\$119.25



**SPRING SHAPE**  
 This drum comes with a beater and can be used to  
 create rhythms by striking the pretuned RENAISSANCE®  
 drumhead and rim. Or, just shake it and  
 experience its mysterious sound!  
**SS0319NS**.....\$31.00



**SOUND SHAPES**  
**SS200005** NSL Drumhead Material and  
 Dedicated Colors on Each of  
 5 Circle Shapes .....\$135.00  
 15" Red, 12.75" Yellow, 10.5" Orange,  
 8.25" Green, 6" Blue



**SS300005** Five Shapes: 9" triangle, 6.5" x 9"  
 rectangle, 9" square, 9" round and  
 9" Half Round .....\$120.50

**ARTHUR HULL FACILITATOR KIT**  
**SS1000AH** 5 Circle Sound Shapes Packs  
 (25 Pieces) Dedicated Colors.  
 15" Red, 12.75" Yellow,  
 10.5" Orange, 8.25" Green,  
 6" Blue.....\$585.00

www.remo.com

## TIMBALES

### MATADOR/ASPIRE



14" & 15" Metal Shell Drums with stand sticks,  
 cowbell and holder.  
**M257** Matador, Chrome .....\$579.00  
**LPA256** Aspire 13" & 14", 6½" Deep .....\$367.00  
**M259** Timbale Stand .....\$192.00

### TITO PUENTE TIMBALES



**LP257B** Brass, 14" x 15", w/stand .....\$929.00  
**LP257S** Steel, 14" x 15", w/stand .....\$896.00

**POCKET SHAKER**  
**SR0124** 3½" x 12" .....\$8.70B

## BELL SETS

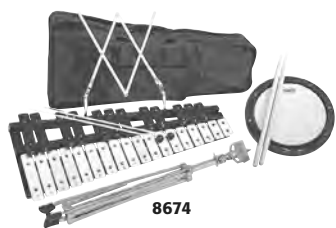

8674

### CB PERCUSSION KIT

2½ octave aluminum satin finish bells. Rugged heavy duty extended height stand. Includes 8" tunable pad, music rack, back pack and mallets.

8674 .....\$338.25  
8676 w/Bag w/Wheels .....413.00  
8674STD Stand .....98.70



### BELL KIT

Enamel finish aluminum bars. Choice of two popular sizes. Includes duotone double ended mallets.

6855 25 note w/bag .....\$110.75

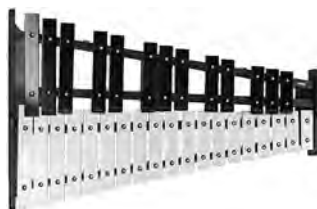

### CLEVELANDER

A top quality student roller bell kit and back pack kit. Precisely toned notes make this an exceptional value for a Clevelander item w/backpack case.

TR9032 32 Note .....\$383.40

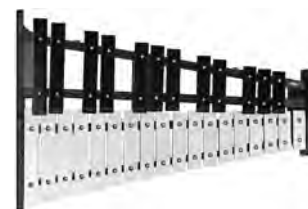

### CLEVELANDER

A top quality student roller bell kit and back pack kit. Precisely toned notes make this an exceptional value for a Clevelander item w/backpack case.

TR9030 30 Note .....\$347.40



### CANNON PERCUSSION KIT

2½ octave aluminum bell kit, featuring 30 notes from G to C. Included is pad/bell stand, nylon bag, practice pad, drum sticks and mallet.

UPMPK .....\$418.00



### PERCUSSION KIT

2.5+ octave bells F5-C8 with neoprene bar mounting and ABS end plates. Bell bars stamped with pitch letter names. 14" x 3½" 10-lug chrome piccolo snare drum.

7106 w/bag, wheels .....\$629.00



### RESONATOR

Removable bells

8948 25 note w/case .....\$254.40B



### BELL KIT

Enamel finish aluminum bars. Choice of two popular sizes. Includes duotone double ended mallets

6854 25 note w/case .....\$143.05



### RESONATOR

Bells can be removed from case and held in hand by multiple players.

T1750 8 note w/case .....\$45.00



Two chromatic octaves with crisp resonance and projection.

T1700 25 Note .....\$39.50

T1727 27 Note .....75.00



### STUDENT XYLOPHONE

2 octaves. Metal bars. Includes plastic carrying case and mallets.

YHXP25K 25 Note, A-A .....\$41.30

YHXP27K 27 Note, G-A .....48.00



### XYLOPHONE

Beautiful, solid wood xylophones are handcrafted and tuned in Europe.

FN908 8 Note, Wooden .....\$54.00

FN915 15 Note, Wooden .....66.00

**FAX & E-MAIL  
ORDERS FOR  
PRINTED MUSIC  
WILL GET AN EXTRA  
5% DISCOUNT**

**FAX:  
(708) 496-2130  
(888) 983-5537**

**E-MAIL:  
sales@harristeller.com**

## BELL SET BAGS



**KACES  
KUBK20 .....\$99.35  
KUBK20W w/wheels .....153.80**



V7806B

### VIC FIRTH

V7806B Traveler Virtuoso Performer Kit Bag w/wheels .....\$181.80

V8000B Traveler Percussion Kit Bag w/wheels .....154.45

V8705B Backpack Percussion Kit Bag .....92.00



V8000B

## SNARE KITS



8 Lug, 5 1/2" x 14" chrome drum with pad, stand, sticks & back pack.  
**DS005** .....\$181.40



8 Lug, 5 1/2" x 14" chrome snare, with stand, sticks, cymbal, holder.  
**SK10D** .....\$205.50



5 1/2" x 14" black snare drum with 8 lugs, Rubber practice pad, tall heavy duty double braced snare stand, sticks and bag w/compartments for snare drum stand sticks.  
**MSK10** .....\$220.00



• 5 1/2" X 14" 10-Lug steel rim  
 • Chrome finish  
 • Extended height heavy duty stand  
 • Fully padded deluxe nylon backpack bag  
 • Includes sticks & Gladstone style pad  
**IS678BP** .....\$279.50

## SNARE/PERC KIT



2.5+ octave bells F5-C8 with neoprene bar mounting and ABS end plates, bell bars stamped with pitch letter names, 4" x 14" 8-lug chrome piccolo snare drum, Gibraltar-designed wide tripod base stand with bell & snare drum stand tops, traveler bag with wheels, retractable handle, ABS perimeter reinforcements.  
**7106** .....\$629.00

## CANNON SNARE DRUMS



**Chrome**  
**SD6508** 6 1/2" x 14", 8 Lugs .....\$324.00  
**SD526** 6 1/2" x 14", 10 Lugs .....\$330.00  
**SD5508** 5 1/2" x 14", 8 Lugs .....\$312.00

## SNARE DRUM BAGS



**B4689** Back Pack Snare Bag, TKL .....\$45.25  
**KDP16** Kaces Back Pack Snare Bag .....\$61.80  
**KDP160W** Snare Kit Porter w/wheels .....\$95.65  
**IS678B** Deluxe Back Pack Bag .....\$81.45  
**KCKW1** Snare/Bell Kit Duo w/wheels .....\$173.80

## BEATNIK



Beatnik™ Rhythmic Analyzers for Percussion from OnBoard Research will help you improve your rhythmic accuracy in ways never before possible.  
**RA1200P** .....\$189.95  
**RA800P** .....\$119.95

## LP AMERICANA OCTO-SNARE CAJON



9-ply, Baltic birch wood shells, fixed internal snares, dual playing surfaces, beautiful, natural finish, 12" Sapele wood playing surfaces. Also available in 10" size. Made in U.S.A. Meets Phase II CARB Compliance and LACEY Act Standards.  
**LP1410** 10" .....\$159.00  
**LP1412** 12" .....\$199.00

## VIC FIRTH KIT BAGS



**V7806B**



**V6000B**



**V8000B**

**V6000B** Traveler Snare Drum Kit Bag .....\$138.00  
**V6705B** Backpack Snare Drum Kit Bag .....\$86.00  
**V7806B** Traveler Virtuoso Performer Kit Bag .....\$181.60  
**V8000B** Traveler Percussion Kit Bag w/Wheels .....\$154.45  
**V8705B** Backpack Percussion Kit Bag .....\$92.00

## DRUM RECOVER MATERIAL

Custom design your kit with these 24" x 54" sheets of drum covering material.

To Recover	Requires
14" x 14" Drum	1 sheet each
16" x 16" Drum	1 sheet each
16" x 18" Drum	2 sheets each
14" x 20" Drum	2 sheets each
16" x 20" Drum	2 sheets each
14" x 22" Drum	2 sheets each
16" x 22" Drum	2 sheets each
14" x 24" Drum	2 sheets each
16" x 24" Drum	2 sheets each
14" x 26" Drum	2 sheets each
16" x 26" Drum	2 sheets each

24" x 54" sheet. Available in Black (BK), White (W), Red (R)

**CM** .....\$59.95



## RHYTHM TECH



### TRUE COLORS

<b>10" Double Row</b> .....	<b>\$26.95</b>
<b>TC4010</b> Black	
<b>TC4020</b> White	
<b>TC4030</b> Red	
<b>TC4040</b> Blue	
<b>TC4050</b> Yellow	
<b>8" Single Row</b> .....	<b>\$14.95</b>
<b>TC4018</b> Black	<b>TC4038</b> Red
<b>TC4028</b> White	<b>TC4048</b> Blue
<b>TC4058</b> Yellow	



RT7420

### HAT TRICK DOUBLE HAT TRICK

<b>RT7420</b> G2 (Nickel) .....	<b>\$40.95</b>
<b>RT7421</b> G2 (Brass) .....	<b>42.95</b>
<b>RT7422</b> Double G2 (Nickel) .....	<b>50.95</b>
<b>RT7423</b> Double G2 (Brass) .....	<b>52.95</b>
<b>RT7430</b> Rhythm Tech Hat Shake G2 .....	<b>40.95</b>
<b>MAH8N</b> Chingle Ring Nickel .....	<b>37.00</b>

### SOLO



Single row, 8 pairs nickel jingles.

<b>RT1210</b> Black .....	<b>\$23.95</b>
<b>RT1220</b> White .....	<b>23.95</b>
<b>RT1230</b> Red .....	<b>23.95</b>
<b>RT1280</b> Purple .....	<b>23.95</b>

### JINGLE STICKS



<b>LP180</b> Black .....	<b>\$42.00</b>
<b>LP182</b> Jingle Kick w/6 pairs of dimpled brass jingles .....	<b>46.00</b>
<b>LP187</b> Black w/Brass Jingles .....	<b>46.00</b>
<b>RTH</b> Handbournine Regal Tip .....	<b>36.00</b>



### TAMBOURINES

<b>Steel Jingles</b> .....	<b>\$45.95</b>
<b>RT1010</b> Black	
<b>RT1020</b> White	
<b>RT1030</b> Red	
<b>RT1040</b> Blue	
<b>RT1050</b> Yellow	
<b>RT1080</b> Purple	

<b>Brass Jingles</b> .....	<b>\$50.95</b>
<b>RT1011</b> Black	
<b>RT1021</b> White	
<b>RT1031</b> Red	
<b>RT1041</b> Blue	
<b>RT1051</b> Yellow	
<b>RT1081</b> Purple	

<b>Pro Steel Jingles</b> .....	<b>\$61.95</b>
<b>RTPRO10</b> Black/Grey	
<b>RTPRO20</b> White/Blue	
<b>RTPRO30</b> Red/Grey	

<b>Pro Brass Jingles</b> .....	<b>\$61.95</b>
<b>RTPRO11</b> Black/Grey	
<b>RTPRO21</b> White/Blue	
<b>RTPRO31</b> Red/Grey	

<b>Tambino</b> .....	<b>\$14.95</b>
<b>RT1500</b> Blue/Pink	
<b>RT1580</b> Purple/Orange	



### DST

<b>Steel Jingles</b> .....	<b>\$47.95</b>
<b>DST10</b> Black	
<b>DST20</b> White	
<b>DST30</b> Red	
<b>DST40</b> Blue	

<b>Brass Jingles</b> .....	<b>\$51.95</b>
<b>DST 11</b> Black	
<b>DST 21</b> White	
<b>RT7902</b> Mounting Bracket .....	<b>35.95</b>
<b>RT7903</b> Sideman Mount .....	<b>20.95</b>

## BLACK SWAMP



### SYNTHETIC HEAD

Solid Ash Shell / Remo Renaissance Head

<b>BSTD1S</b> Double Row 10" - Chromium 25 Jingles .....	<b>\$220.00*</b>
<b>BSTD2S</b> Double Row 10" - Phosphor Bronze Jingles .....	<b>220.00*</b>
<b>BSTD3S</b> Double Row 10" - German Silver Jingles .....	<b>225.00*</b>
<b>BSTD4S</b> Double Row 10" - Beryllium Copper Jingles .....	<b>252.00*</b>
<b>BSTC1S</b> Double Row 10" - Chromium/Bronze Jingles .....	<b>220.00*</b>
<b>BSTC2S</b> Double Row 10" - Chromium/Silver Jingles .....	<b>225.00*</b>



### CALF HEAD

Solid Ash Shell / Clear Calf Head

<b>BSTD1</b> Double Row 10" - Chromium 25 Jingles .....	<b>\$233.00*</b>
<b>BSTD2</b> Double Row 10" - Phosphor Bronze Jingles .....	<b>233.00*</b>
<b>BSTD3</b> Double Row 10" - German Silver Jingles .....	<b>240.00*</b>
<b>BSTD4</b> Double Row 10" - Beryllium Copper Jingles .....	<b>265.00*</b>
<b>BSTC1</b> Double Row 10" - Chromium/Bronze Jingles .....	<b>233.00*</b>
<b>BSTC2</b> Double Row 10" - Chromium/Silver Jingles .....	<b>240.00*</b>

### Special Order Items - Additional lead time required

<b>BSTS1</b> Single Row 10" - Chromium 25 Jingles .....	<b>\$206.00*</b>
<b>BSTS3</b> Single Row 10" - German Silver Jingles .....	<b>212.00*</b>
<b>BSTS4</b> Single Row 10" - Beryllium Copper Jingles .....	<b>225.00*</b>



### 12" SINGLE ROW TAMBOURINES

Special Order Items - Additional lead time required

<b>BST121</b> Single Row 12" - Chromium 25 Jingles .....	<b>\$198.00*</b>
<b>BST123</b> Single Row 12" - German Silver Jingles .....	<b>205.00*</b>
<b>BST124</b> Single Row 12" - Beryllium Copper Jingles .....	<b>220.00*</b>
<b>BSTC121</b> Single Row 12" - Chromium/Bronze Jingles .....	<b>198.00*</b>

### OVERTURE SERIES

10-ply Maple Shell/Remo Renaissance Head/Brass Jingles, Double Row 10".

<b>BSTD0V</b> .....	<b>\$152.00*</b>
---------------------	------------------



### TAMBOURINE ACCESSORIES

<b>BSTCR</b> Tambourine Cradle for table or stand mounting .....	<b>\$132.00*</b>
<b>BSTB10</b> Tambourine Bag, fits 8" and 10" tambourine .....	<b>44.00*</b>
<b>BSTB12</b> Tambourine Bag, fits 12" tambourine .....	<b>53.00*</b>
<b>BSTHR10C</b> Head replacement kit for 10" tambourine with #TCG .....	<b>48.00*</b>
<b>BSTHR10</b> Head replacement kit for 10" tambourine without #TCG .....	<b>53.00*</b>
<b>BSTHR12</b> Head replacement kit for 12" tambourine .....	<b>65.00*</b>
<b>BSBWX</b> Beexwax thumbroll compound .....	<b>12.00*</b>

\* = CALL FOR NET PRICING ON BLACK SWAMP

# REMO TAMBOURINES/WORLD PERCUSSION

## TAMBOURINES WITH FIXED HEADS

TA5106	6" Single Row Jingles.....	\$29.40
TA5108	8" Single Row Jingles.....	33.60
TA5110	10" Single Row Jingles.....	36.90
TA5208	8" Double Row Jingles.....	41.00
TA5210	10" Double Row Jingles.....	47.30

## HEADLESS TAMBOURINES

TA6106	6" Single Row Jingles.....	\$18.70
TA6108	8" Single Row Jingles.....	22.80
TA6110	10" Single Row Jingles.....	24.20
TA6208	8" Double Row Jingles.....	29.40
TA6210	10" Double Row Jingles.....	32.50

## PRIZMATIC TAMBOURINES

Black Quadura™ covered shells.  
Please specify: Radiant Black (47) or Radiant (48)  
Prismatic Heads.

TA410648	6" Single Row.....	\$34.70
TA410848	8" Single Row.....	44.30
TA4110/47/48	10" Single Row.....	49.80
TA420848	8" Double Row.....	53.10
TA4210/47/48	10" Double Row.....	60.00

## RELIGIOUS THEME TAMBOURINES

### Single Row of Jingles

TA910614	6" "Praying Hands".....	\$29.40
TA910615	6" "Gold Cross".....	29.40
TA910616	6" "Cross of Glory".....	29.40
TA910617	6" "Heavenly Light".....	29.40
TA910618	6" "Dove".....	29.40

TA910814	8" "Praying Hands".....	\$34.70
TA910815	8" "Gold Cross".....	34.70
TA910816	8" "Cross of Glory".....	34.70
TA910817	8" "Heavenly Light".....	34.70
TA910818	8" "Dove".....	34.70

TA911014	10" "Praying Hands".....	\$40.20
TA911015	10" "Gold Cross".....	40.20
TA911016	10" "Cross of Glory".....	40.20
TA911017	10" "Heavenly Light".....	40.20
TA911018	10" "Dove".....	40.20

### Double Row of Jingles

TA920814	8" "Praying Hands".....	\$42.60
TA920815	8" "Gold Cross".....	42.60
TA920816	8" "Cross of Glory".....	42.60
TA920817	8" "Heavenly Light".....	42.60
TA920818	8" "Dove".....	42.60

TA921014	10" "Praying Hands".....	\$47.30
TA921015	10" "Gold Cross".....	47.30
TA921016	10" "Cross of Glory".....	47.30
TA921017	10" "Heavenly Light".....	47.30
TA921018	10" "Dove".....	47.30

## GOSPEL TAMBOURINE

TA301081	10" Fixed Head, 8 Double-Row Jingles, Antique Finish.....	\$70.40
----------	---	---------



BLACK  
14



BLUE  
15



GREEN  
16



BLUE  
17



## ECONOMY TAMBOURINES

### WITH SMOOTH WHITE HEADS

TA5106ML	6" Single Row Jingles.....	\$20.90
TA5108ML	8" Single Row Jingles.....	26.70
TA5110ML	10" Single Row Jingles.....	29.40
TA5208ML	8" Double Row Jingles.....	33.60
TA5210ML	10" Double Row Jingles.....	36.60



## BUFFALO DRUMS

Comes with a rope suspension handle, mallet, and a choice of graphic or plain heads that can be self-decorated. All Remo Buffalo drums are manufactured with Fiberskyn®3 drumheads and Acousticon® drum shells.

E10308	3.5" x 8".....	\$50.30
E10310	3.5" x 10".....	56.90
E10312	3.5" x 12".....	65.50
E10314	3.5" x 14".....	76.70
E10316	3.5" x 16".....	92.10
E10322	3.5" x 22".....	130.80
E1031410	3" x 14" Buffalo Image on Head.....	124.40
E1031411	3" x 14" Sun Buffalo.....	124.40
E1031610	3" x 16" Buffalo Image on Head.....	143.40

## HAND DRUMS, FIXED HEAD

Sizes 12, 14, 16 and 22 feature a thumb notch and four holes located around the circumference of the Acousticon® shell. The four holes can be used to weave a rope creating a handle to suspend the drum which increases the projection when struck with a mallet or hand. **Walnut finish.**

HD8508	2.5" x 8".....	\$33.00
HD8510	2.5" x 10".....	35.20
HD8512	2.5" x 12".....	44.00
HD8514	2.5" x 14".....	50.90
HD8516	2.5" x 16".....	57.20
HD8522	2.5" x 22".....	83.60

## RENAISSANCE® FRAME DRUMS

High quality, affordable frame drums for use by professionals, educators and beginners. Weather resistant, easy to maintain, and widely appreciated for its clarity of sound. **Medium oak finish.**

HD8408	8" x 2".....	\$33.20
HD8410	10" x 2".....	36.40
HD8412	12" x 2.5".....	43.60
HD8414	14" x 2.5".....	50.40
HD8416	16" x 2.5".....	56.90
HD840006	Set of 6.....	227.00

## PANDEIROS/TAMBORIM



Tunable with Single Row of Triple Jingles.  
PD8213CE 2" x 13" Prismatic Head..... \$146.05

### Tamborin

Tunable, 6" Diameter, Brilliantburst, Clear Tone Drumhead, produced bright, sharp tones.

TM72061G	.....	\$64.10
PD821081	10" x 1.75".....	222.90

Choro Pandeiro key tuned four combo brass jingle set in five slots

www.remo.com

## JOHN BERGAMO FRAME DRUM

Legacy-LA Head w/Thumb Notch, Acousticon 516 Shell with Wood Veneer.

ET8207JB	2" x 7" Kanjira.....	\$108.90
----------	----------------------	----------



ET0212



ET021210

## OCEAN DRUMS

ET0212	2.5" x 12".....	\$68.50
ET0216	2.5" x 16".....	87.75
ET0222	2.5" x 22".....	123.50

### With graphics

ET021210	2.5" x 12".....	\$76.00
ET021610	2.5" x 16".....	98.25
ET022210	2.5" x 22".....	135.50



## THINLINE FRAME DRUMS

There is no drum more simple, reliable, lightweight, attractive, primary, basic, essential AND affordable than the Remo® Thinline Frame Drum. Manufactured with a Renaissance® fixed drumhead, the Remo® Thinline Frame Drum is both a training drum, accessible for beginners, and also a great practice drum for professionals.

HD8908	8" x 1 1/16".....	\$39.90
HD8910	10" x 1 1/16".....	42.25
HD8912	12" x 1 1/16".....	47.75
HD8914	14" x 1 1/16".....	51.00
HD8916	16" x 1 1/16".....	61.00
HD890005	8, 10, 12, 14, 16" Drums with Bag.....	270.50

## LUDWIG TAMBOURINES

LLE4022	Pro-10" Single Row w/Skin Head.....	\$79.80B
LLE4023	Pro-10" Double Row w/Skin Head.....	96.60B

## TAMBOURINE HOLDER



Mounts any model tambourine on Hi hat rod or top of cymbal stand. Side mounting leaves cymbal area open.

DAN308	.....	\$21.00
--------	-------	---------



ALESSANDRA BELLONI	.....	
TA2516AB	Tambourine.....	\$130.80





## LP PROFESSIONAL TAMBOURINES

High quality USA nickel silver jingles produce a bright crisp tone. 10" diameter Asian Oak shell with rounded edges and finger hole for a comfortable, secure hold.

- LP380A** Single Row, 8 pairs of nickel-silver alloy jingles .....\$125.00
- LP380B** Double Row, 16 pairs of nickel-silver alloy jingles .....177.00

## LP CYCLOPS TAMBOURINES

### HAND HELD

- LP150** Black .....\$48.00
- LP151** Red .....48.00
- LP152** White .....48.00
- LP150GLO** Glow in the Dark .....48.00

### MOUNTABLE

- LP160** Black .....\$54.00
- LP161** Red .....54.00
- LP236C** Mounting Bracket .....47.00

## CP TAMBOURINES

The CP Wood Tambourines have solid wood shells and bright, cutting jingles. The headed tambourines are made with real calf heads that are mounted in a traditional manner.

### SKIN HEAD

- CP376** 6" - Single jingles .....\$15.00
- CP378** 8" - Single jingles .....18.00
- CP379** 10" - Single jingles .....22.00
- CP380** 10" - Double jingles .....25.00

### HEADLESS

- CP388** 8" - Single jingles .....\$17.00
- CP389** 10" - Single jingles .....18.00
- CP390** 10" - Double jingles .....23.00

### TUNABLE

- CP391** 10" - Wood, double row .....\$52.00
- CP392** 10" - Metal, double row .....64.00
- TH1** 10" - Replacement Head, plastic .....6.80
- CP375** 10" - Replacement Head, plastic .....14.00
- CP398** 10" - Replacement Head, skin .....22.00

### PLASTIC, HEADLESS

- WB990** 8" - Black, Single Row .....\$16.00
- LPA180** 8" - Black, Single Row .....19.00
- LPA181** 8" - Red, Single Row .....19.00
- LPA190** 10" - Black, Double Row .....29.00
- LPA191** 10" - Red, Double Row .....29.00

### ACCESSORIES

- JINGLES**
- TJ55M** 12 Jingles .....\$6.00

## TROPHY TAMBOURINES

Imported From Pakistan

### HEADLESS

- W206** 6" Single Jingles .....\$7.50
- W208** 8" Single Jingles .....9.55
- W210** 10" Single Jingles .....10.50
- W210D** 10" Double Jingles .....13.50

### SKIN HEADS

- W306** 6" Single Jingles .....\$8.95
- W308** 8" Single Jingles .....10.50
- W310** 10" Single Jingles .....12.55
- W310D** 10" Double Jingles .....15.55



## TAMBOURINES

### GROVER PRO PERCUSSION

- SVTAMB** 10" Double Jingles .....\$101.00\*
- T1GS** 10" Single Jingle Silver .....200.00\*
- T2GS** 10" Double Jingles Silver .....221.00\*
- T2PHBR** 10" Double Jingles Bronze .....221.00\*
- HK10** 10" Head Kit .....46.00\*

\* = Call for Price

### JINGLE STICKS

- LP180** Black .....\$42.00
- LP182** Jingle Kick w/6 pair of Dimpled Brass Jingles .....46.00
- LP187** w/Brass Jingles .....46.00

### TROPHY

- TR4900** 8" plastic .....\$7.00

### LP

- LPPER007** Percusso .....\$73.00

7.5" Wood Tambourine with skin head. Excellent quality, individually boxed.

- B350R** Red .....\$10.00
- B350Y** Yellow .....10.00
- B350B** Blue .....10.00

### BLACK SWAMP 10" DOUBLE JINGLE

- BSTD1** Chromium 25™ Jingles .....\$233.00\*
- BSTD2** Double Row 10" - Phosphor Bronze Jingles .....233.00\*
- BSTD3** German Silver Jingles .....240.00\*
- BSTC1** Chromium/Bronze Jingle Mix .....233.00\*
- BSTC2** Double Row 10" - Chromium/Silver Jingles .....240.00\*

\* = Call for Cost

### VIC FIRTH

- V408** 8" Concert .....\$30.25

### CANNON

- TAMB6S04H** 6" Single Jingles .....\$11.00
- TAMB8S05H** 8" Single Jingles .....12.95
- TAMB10S06H** 10" Single Jingles .....18.95
- TAMB8D12H** 8" Double Jingles .....16.65
- TAMB10D16H** 10" Double Jingles .....19.55

### HALF MOON DOUBLE JINGLE

- HMBK** Black .....\$18.50
- HMW** White .....18.50
- HMR** Red .....18.50
- HMB** Blue .....18.50
- HMY** Yellow .....18.50

### LP CYCLOPS JINGLE RINGS

- LP191** Steel Jingles .....\$42.00
- LP192** Brass Jingles .....46.00

## QUAD RACK



The original steel percussion rack. This rack will accommodate any combination of instruments.

- DAN20A** .....\$90.00

## GROVER PRO PERCUSSION



### Grover Pro Tambourines

Projection-Plus™ Series – Solid-Shell, Natural Calf Head, Includes Bag.

#### Double Row Models

<b>T2HTS8</b>	8" Double Row Heat-Treated Silver Tambourine .....	<b>\$214.00*</b>
<b>T2GS8</b>	8" Double Row German Silver Tambourine .....	<b>202.00*</b>
<b>T2GS</b>	10" Double Row German Silver Tambourine.....	<b>221.00*</b>
<b>T2BC</b>	10" Double Row Beryl. Copper Tambourine.....	<b>247.00*</b>
<b>T2HTC</b>	10" Double Row Heat-Treated Copper Tambourine .....	<b>253.00*</b>
<b>T2HTS</b>	10" Double Row Heat-Treated Silver Tambourine.....	<b>235.00*</b>
<b>T2GSPH</b>	10" Double Row GS/PhBr Combo Tambourine.....	<b>227.00*</b>
<b>T2PHBR</b>	10" Double Row Phos. Bronze Tambourine.....	<b>221.00*</b>
<b>T2HS</b>	10" Double Row Hybrid Silver Tambourine.....	<b>229.00*</b>
<b>T2BCX</b>	10" Double Row Beryl. Copper Tambourine w/Synthetic Head.....	<b>247.00*</b>
<b>T2GSPHX</b>	10" Double Row GS/PhBr Combo Tambourine w/Synthetic Head .....	<b>227.00*</b>
<b>T2GSX</b>	10" Double Row German Silver w/Synthetic Head .....	<b>221.00*</b>

#### Single Row Models

<b>T1GS</b>	10" Single Row German Silver Tambourine .....	<b>\$200.00*</b>
<b>T1PHBR</b>	10" Single Row Phos. Bronze Tambourine .....	<b>200.00*</b>
<b>T1BC</b>	10" Single Row Beryl. Copper Tambourine.....	<b>229.00*</b>
<b>T1GS12</b>	12" Single Row German Silver Tambourine.....	<b>217.00*</b>

Our **SV™ Tambourine** features an 8-ply Maple shell, quality stamped brass alloy jingles, a natural skin head, and Grover exclusive dual-size jingle slots. This double-row tambourine is ten inches in diameter and has a clear-coat protective finish.

<b>SVTAMB</b>	SV Tambourine, 10" Double-Row .....	<b>\$101.00B</b>
<b>SVTAMBKIT</b>	10" Double-Row, includes CTB tambourine bag and Roll Ring™ .....	<b>133.00B</b>

#### Tambourine Accessories

<b>TW</b>	Tambourine Beeswax.....	<b>\$11.00*</b>
<b>CTB</b>	Black Cordura Bag for 10" Tambourine.....	<b>30.00*</b>
<b>CTB12</b>	Black Cordura Bag for 12" Tambourine.....	<b>30.00*</b>
<b>HK</b>	10" Head Kit, Premium Skin Head, Special Mounting Band & Instructions.....	<b>46.00*</b>

Our new **Roll Ring™** is designed to aid concert percussionists with the execution of thumb/finger tambourine rolls.

<b>RR8</b>	8" Roll Ring.....	<b>16.00*</b>
<b>RR10</b>	10" Roll Ring.....	<b>16.00*</b>



### Grover Pro Triangles

<b>TR5</b>	5" Super-Overtone w/bag.....	<b>\$88.00*</b>
<b>TR6</b>	6" Super-Overtone w/bag.....	<b>90.00*</b>
<b>TR9</b>	9" Super-Overtone w/bag.....	<b>98.00*</b>
<b>TRBPH6</b>	6" Bronze Pro Hammered Triangle w/bag.....	<b>194.00*</b>
<b>TRBPH7</b>	7" Bronze Pro Hammered Triangle w/bag.....	<b>199.00*</b>
<b>TRBPH8</b>	8" Bronze Pro Hammered Triangle w/bag.....	<b>204.00*</b>
<b>TRHSH6</b>	6" High Super Harmonic Triangle.....	<b>120.00*</b>
<b>TRHSH8</b>	8" High Super Harmonic Triangle.....	<b>130.00*</b>
<b>TBCSE</b>	Tri Beater Case.....	<b>23.00*</b>
<b>CTS</b>	Small Triangle Bag, up to 6".....	<b>21.00*</b>
<b>CTL</b>	Large Triangle Bag, up to 9".....	<b>21.00*</b>

### Pro Bronze™ Triangles

<b>TRB4</b>	4" Bronze Piccolo Triangle.....	<b>\$53.00B</b>
<b>TRB5</b>	5" Bronze Concert Triangle.....	<b>55.00B</b>
<b>TRB6</b>	6" Bronze Concert Triangle.....	<b>57.00B</b>
<b>TRB7</b>	7" Bronze Symphonic Triangle.....	<b>59.00B</b>
<b>TRB8</b>	8" Bronze Symphonic Triangle.....	<b>61.00B</b>
<b>TRB9</b>	9" Bronze Symphonic Triangle.....	<b>63.00B</b>

### Grover Pro Triangle Accessories

<b>TBD</b>	10 pc. Deluxe Alloy 303 Triangle Beater Set.....	<b>\$100.00*</b>
<b>TBS</b>	6 pc. Standard Alloy 303 Triangle Beater Set.....	<b>64.00*</b>
<b>TBDT</b>	6 pc. Deluxe Tubular Triangle Beater Set.....	<b>100.00*</b>
<b>TBTS</b>	4 pc. Standard Tubular Triangle Beater Set.....	<b>64.00*</b>
<b>S2TBSET</b>	3 pc. Triangle Beater Set.....	<b>29.00B</b>
<b>PTC</b>	Pro Triangle Clip .....	<b>39.60B</b>
<b>DTM</b>	Dual Triangle Mount .....	<b>62.00*</b>
<b>S2TC</b>	Black High-Impact Plastic Triangle Clip.....	<b>16.00B</b>

### Grover Pro Percussion Rock Maple Woodblock

<b>WB10</b>	10" Rock Maple Woodblock.....	<b>\$55.00*</b>
<b>WB7</b>	7" Rock Maple Woodblock.....	<b>49.00*</b>
<b>WB8</b>	8" Rock Maple Woodblock.....	<b>51.00*</b>
<b>WB9</b>	9" Rock Maple Woodblock.....	<b>53.00*</b>

\* CALL FOR DEALER COST

## TOCA TAMBOURINES



### COLOR SOUND TAMBOURINES

A spectrum of 10" painted tambourines that fit any musician's style. Lightweight exotic Acacia hardwood.

#### Double Nickel/Brass Jingle

<b>TCT10B</b>	Toca Blue.....	<b>\$46.00</b>
<b>TCT10G</b>	Toca Green.....	<b>46.00</b>
<b>TCT10R</b>	Toca Red.....	<b>46.00</b>
<b>TCT10W</b>	Toca White.....	<b>46.00</b>
<b>TCT10BK</b>	Toca Black.....	<b>46.00</b>
<b>TCT10PI</b>	Toca Pink.....	<b>46.00</b>

#### Single Nickel/Brass Jingle

<b>T1010D</b>	Toca Dark Wood Matte Finish.....	<b>\$26.10</b>
---------------	----------------------------------	----------------

## LUDWIG TAMBOURINES

<b>LLE4022</b>	Pro-10" Single Row w/Skin Head.....	<b>\$79.80B</b>
<b>LLE4023</b>	Pro-10" Double Row w/Skin Head.....	<b>96.60B</b>

## TAMBOURINE HOLDER



Mounts any model tambourine on Hi hat rod or top of cymbal stand. Side mounting leaves cymbal area open.

<b>DAN308</b>	.....	<b>\$21.00</b>
---------------	-------	----------------

## GROVER PRO PERCUSSION



### PADAUK CONCERT LOG DRUMS

Each Grover log drum features a padauk sound board that is precision cut and tuned using CNC technology. We utilize high grade Baltic birch for the resonator box, chosen for it's strength and stability.

<b>LOG20</b>	20" Log Drum w/Padauk Top ...	<b>\$388.00*</b>
<b>LOG25</b>	25" Log Drum w/Padauk Top.....	<b>414.00*</b>
<b>LOG30</b>	30" Log Drum w/Padauk Top .....	<b>439.00*</b>

## JAMM JR SETS



Available in Black (BK), Wine Red (WR) & Blue (B)

**JAMMJR3** 3 Piece.....\$319.35  
11" x 16" bass drum 12 single lug, 6" x 10" tom 5 double lug, 5" x 10" snare drum 5 double lug, hi-hat stand/cymbal stand/snare stand, bass drum pedal/throne, cymbals: 2-10" & 1-12", drum sticks, drum key.

**JAMMJR5** 5 Piece.....416.85  
11" x 16" bass drum 4 double lug, 6" x 10" and 6" x 8" toms 4 double lug, 10" x 12" floor tom 4 double lug, 5" x 10" snare drum 4 double lug, hi-hat stand/cymbal stand/snare stand, bass drum pedal/throne, cymbals: 2-8" & 1-10", drum sticks, drum key.

## JUNIOR HARDWARE



**JRX11** Bass Drum Pedal .....\$40.90  
**JRX08** Throne-Roundbase.....52.20  
**JRX07C** Hi-Hat Stand w/Cymbals.....104.58

## JUNIOR PACIFIC DRUM SET



**PDJR18KTCB** 5 piece.....\$583.99  
Color: Carbon Black

Drum Sizes: 5" x 8", 5" x 10" Mounted Toms  
10" x 12" Floor Tom w/legs  
14" x 18" Bass Drum  
5" x 12" Matching Snare Drum

Hardware: B.D. Pedal, Snare Stand, Hi-Hat Stand, Cymbal Stand, Throne

Cymbals: 1 pair 10" Hi-Hats  
1 pair 12" Crash

## REMO ROTOTOMS

Genuine Remo RotoToms feature rugged construction, plated counterhoop and tension rod and quality Remo drum heads. Available in seven sizes and in stand-mounted sets.



## ACCESSORIES

**HK0100** Universal Adapter .....\$45.40  
**HK0010** Stand Adapter.....23.40  
**AD0055** 55° Angle Track-to-Track Connector .....18.70  
**MS0024** 24-inch Track.....31.50  
**MS0033** 33-inch Track.....41.80  
**HK220009** 5" Track to Drum Bolt .....11.00

## ROTO TOM STANDS

**ST2000** Economy Stand for One Rototom.....\$105.60  
**ST420410** Heavy Duty Stand with AD10 and MS4.....199.40  
**ST422410** Heavy Duty Stand with AD10 and MS24.....213.70  
**ST423310** Heavy Duty Stand with AD10 and MS33 .....226.30

### Black Epoxy Coated

Highly durable standard finish for general use

6" **ER0006** .....\$128.40  
8" **ER0008** .....141.40  
10" **ER0010** .....167.80  
12" **ER0012** .....193.60  
14" **ER0014** .....219.75  
**ER0680** 6", 8", & 10" Roto Toms w/stand .....544.40

## BSX BASIX®



**D622** 5 piece.....\$699.00  
Available in Black (BK), Wine Red (WR)

5½" x 14" Snare Drum 8" x 10" Tom Tom  
8" x 12" Tom Tom 14" x 14" Floor Tom  
16" x 22 Bass Drum

Throne & Cymbals Included  
All Chrome Plated Hardware & Rims

### Double braced hardware included:

Throne, Snare Stand, Hi-Hat Stand, Cymbal Stand, Bass Drum Pedal.

Cymbals: 13" Hi-Hats, 15" Crash

## ROTO TOMS



6", 8", 10" set with stand

**IS681** .....\$322.80

## TRICK BAG



### PERCUSSION HARDWARE BAG

**RT9000** 22" x 10" x 12½" .....\$54.95

## BASS DRUMRACKS



**BD250** KDS.....\$ 49.99  
**3416** Gibraltar.....139.05  
**UPBDS** Cannon Percussion .....94.00  
**3002** TROPHY .....109.95

# HARDWARE Concept Series



## 800 Series



- 800 Series features:**
- Fine-Toothed Tilter
  - Double-Braced Legs
  - Contoured Wing Screws
  - Oversized Rubber Feet
  - Standard-Gauge Tubing

shown left to right: PDCB800, PDCS800, PDDT820X, PDHH820, PDSS800, PDDT800-04

### Concept Series features:

- Fine-Toothed Tilter
- Double-Braced Legs
- Contoured Wing Screws
- Oversized Rubber Feet
- Heavy-Gauge Tubing
- Integrated Memory Locks

## 700 Series



- 700 Series features:**
- Double-Braced Legs
  - Lightweight Tubing

shown left to right: PDHH700, PDCB700, PDSS700, PDCS700, PDDT700

# PEDALS

Pacific Pedals include pro-style features at a price most drummers can afford. Features like:

- Double chain and sprocket design
- 2-sided beater
- Solid-steel base plate
- Offset adjustable toe clamp
- PDP footboard



### Concept Series

<b>PDTSC90</b>	Double Tom Stand.....	<b>\$163.99</b>
<b>PDAX991</b>	Single Tom Clamp.....	<b>50.99</b>
<b>PDSSC00</b>	Snare Stand.....	<b>145.99</b>
<b>PDCSC00</b>	Straight Cymbal Stand.....	<b>127.99</b>
<b>PDCBC00</b>	Straight/Boom Cymbal Stand.....	<b>136.99</b>
<b>PDHHC20</b>	Rotating 2-leg Hi-Hat Stand.....	<b>199.99</b>
<b>PDHHC00</b>	3-leg Hi-Hat Stand.....	<b>181.99</b>
<b>PDDTC00</b>	Standard Throne.....	<b>181.99</b>
<b>PDAX912</b>	1/2" x 18" Long Cymbal Arm.....	<b>36.99</b>

### Concept Series Bass Drum Pedals

<b>PDSPCXF</b>	Single Bass Drum Pedal.....	<b>\$181.99</b>
<b>PDDPCXF</b>	Double Bass Drum Pedal w/extended ft/board.....	<b>363.99</b>

### 800 Series

<b>PDCB800</b>	Straight/Boom Cymbal Stand.....	<b>\$99.99</b>
<b>PDSS800</b>	Snare Stand.....	<b>109.99</b>
<b>PDCS800</b>	Straight Cymbal Stand.....	<b>90.99</b>
<b>PDDT800</b>	Standard Throne.....	<b>145.99</b>
<b>PDDT820X</b>	Tractor-Style Throne.....	<b>163.99</b>
<b>PDHH820</b>	2-leg Hi-Hat Stand.....	<b>154.99</b>

### 700 Series

<b>PDCB700</b>	Straight/Boom Cymbal Stand.....	<b>\$78.99</b>
<b>PDCS700</b>	Straight Cymbal Stand.....	<b>67.99</b>
<b>PDHH700</b>	3-leg Hi-Hat Stand.....	<b>99.99</b>
<b>PDDT700</b>	Standard Throne.....	<b>99.99</b>
<b>PDSS700</b>	Snare Stand.....	<b>87.99</b>



**PACIFIC DRUMS  
& PERCUSSION**



**MAIN STAGE**

The all-new Mainstage is a pre-configured entry level kit that includes drums, pedals, hardware, cymbals and even a throne. The drums feature hardwood construction in a durable wrapped finish. Sabian cymbals and a full hardware pack complete the rig. Drum sizes are 8 x 10" & 9 x 12" toms, 14 x 16" floor tom, 18 x 22" bass drum and 5 x 14" matching snare. The hardware pack includes a CB700 cymbal boom stand, CS700 straight cymbal stand, SS700 snare stand, HH700 hi-hat stand and a drum throne. The 4-piece cymbal pack includes 13" top and bottom hi-hats, 20" ride and 16" crash. Cymbals are included with kit in the US only. Other international markets may vary.

- PDMA22KTBZ** Bronze Metallic Main Stage Complete Kit – Shells, HW, Throne & Sabian Cymbals.....**\$1,166.99**
- PDMA22KTBK** Black Metallic Main Stage Complete Kit – Shells, HW, Throne & Sabian Cymbals .....**1,166.99**
- PDMA22KTW** White Main Stage Complete Kit – Shells, HW, Throne & Sabian Cymbals .....**1,166.99**

**SNARE DRUMS**



**805 SERIES BLACKOUT**

- All Maple Shell
- Black Lacquer with Black hardware
- Includes 10.5 mm drum mount
- PDBB0610** 6 x 10".....**\$236.99**
- PDBB0413** 4 x 13".....**272.95**
- PDBB0514** 5 x 14".....**272.95**



**SX SNARE DRUM**

- SX Natural Wood Hoop Snare – 10-ply All-Maple Shell with Maple Hoops, a Natural Lacquer finish, and retro-style.
- SX5514NAWH 5.5" x 14"**  
Wood Snare.....**\$454.99**

**CONCEPT SERIES (SHELL PACKS)**

Concept Series is a new line of PDP drums that are available in both all-maple or all-birch shells. All shells are 7-ply, except for the snare which is 10-ply. Included DW-style STM mounting systems. True Pitch™ tuning, F.A.S.T. tom sizing, proportional counter hoop sizing, and Remo drum heads. Snare drums come with the DW MAG throw-off and boutique-style copper wires. Bass drums come with die-cast claw hooks, and all drums feature the new retro-inspired dual-turret tube lug. Sizes are: 8x10" Rack Tom, 9x12" Rack Tom, 14x16" Floor Tom, 5.5x14" Snare Drum, 18x22" Bass Drum.

Concept Maple drums are available in six specialty high-gloss finishes, all with chrome hardware, except for pearlescent black (black hardware). Concept Birch drums share all of the great features of Concept Maple, but will all-birch shells. They are available in two different configurations with a full range of add-on drums. Choose from two transparent lacquer burst options, both with chrome hardware.

- PDCB2215CB** Birch Drum Set – Cherry to Black Fade.....**\$1,133.99**
- PDCB2215NC** Birch Drum Set – Natural to Charcoal Fade.....**1,133.99**
- PDCM2215NA** Maple Drum Set – Natural Lacquer.....**1,216.99**
- PDCM2215PB** Maple Drum Set – Pearlescent Black.....**1,216.99**
- PDCM2215PW** Maple Drum Set – Pearlescent White.....**1,216.99**
- PDCM2215RB** Maple Drum Set – Red to Black Fade.....**1,216.99**
- PDCM2215SB** Maple Drum Set – Silver to Black Fade.....**1,216.99**
- PDCM2215TC** Maple Drum Set – Transparent Cherry.....**1,216.99**
- PDCM2215TW** Maple Drum Set – Transparent Walnut.....**1,216.99**

**No hardware or cymbal included**

**PDP DRUM HARDWARE PACKAGE**

- One each of:
- HH800-01 3-leg Hi-Hat
- CB800 Straight/Boom Cymbal Stand
- SP450 Single Pedal
- CS800 Straight Cymbal Stand
- SS800 Snare Stand

- PDBXHW8155** .....**\$454.99**

## DRUM SLINGS



<b>PARADE DRUM</b>	
Slide buckle for adjustment. 2" wide, white webbing.	
<b>3312</b> .....	<b>\$19.95</b>
<b>6550</b> .....	<b>12.00</b>
<b>UP3312</b> .....	<b>20.00</b>
<b>4447</b> .....	<b>22.40</b>

<b>BASS DRUM</b>	
Carries drum weight on back and shoulders. Heavy wide, white webbing	
<b>3314</b> .....	<b>\$40.00</b>
<b>UP3314</b> .....	<b>26.00</b>
<b>4446</b> .....	<b>32.70</b>

<b>LEG RESTS</b>	
<b>3553</b> .....	<b>\$31.10</b>
<b>3210</b> .....	<b>24.50</b>
<b>UPPR200</b> Lug Mount.....	<b>34.00</b>
<b>UPPR400</b> Rim Mount.....	<b>43.00</b>
<b>3555</b> White Pad.....	<b>22.70</b>

<b>LUDWIG</b>	
<b>LLF382B</b> Parade, Blk.....	<b>\$26.50B</b>
<b>LLF382W</b> Parade, Wht.....	<b>24.60B</b>
<b>LLF349B</b> Cad BD, Blk.....	<b>57.00</b>
<b>LLF361B</b> Waist, Blk.....	<b>15.15B</b>
<b>LLF350B</b> B.D. Blk.....	<b>39.70B</b>
<b>LLF350W</b> B.D. Wht.....	<b>39.70B</b>



## DRUM CARRIERS



<b>KDS</b>	
<b>3400SC</b> Snare Drum.....	<b>\$180.90</b>
<b>3400BC</b> Bass Drum.....	<b>180.90</b>
<b>M897</b> Angle Bracket.....	<b>19.95</b>
<b>4422</b> Carrier Bar.....	<b>17.10</b>

## SKB CASES



<b>SKBDH3315W</b> Hardware Case (33" x 15" x 14") w/wheels.....	<b>\$294.00</b>
<b>SKBH4810W</b> Small Stand Case (48" x 10") – Wheels.....	<b>269.99</b>
<b>SKBH4812W</b> Regular Stand Case (48" x 12") – Wheels & Straps.....	<b>404.99</b>
<b>SKBH4816W</b> Large Stand Case (48" x 16") – Wheels & Straps.....	<b>469.99</b>
<b>SKBDS1</b> Drum Set Kit 1: 9 x 10, 10 x 12, 12 x 14, 18 x 22.....	<b>764.99</b>
<b>SKBTPX1</b> Trap Case with shelf.....	<b>593.99</b>
<b>SKBTPX2</b> Trap case w/shelf (large).....	<b>599.99</b>
<b>SKBH5020W</b> XL Stand Case (48" x 19") – Wheels.....	<b>449.99</b>
<b>SKBCV8</b> Cymbal Vault.....	<b>205.99</b>
<b>SKBCV24W</b> Cymbal Vault w/wheels.....	<b>242.99</b>
<b>SKBH3611W</b> Trap Case 36.5" x 11.5" x 8" – Wheels & Straps.....	<b>339.99</b>
<b>SKBD0810</b> 8 x 10 Tom.....	<b>139.99</b>
<b>SKBD0812</b> 8 x 12 Tom.....	<b>149.99</b>
<b>SKBD0910</b> 9 x 10 Tom.....	<b>144.99</b>
<b>SKBD0913</b> 9 x 13 Tom.....	<b>164.99</b>
<b>SKBD1012</b> 10 x 12 Tom.....	<b>171.99</b>
<b>SKBD1113</b> 11 x 13 Tom.....	<b>181.99</b>
<b>SKBD1214</b> 12 x 14 Tom.....	<b>188.99</b>
<b>SKBD1414</b> 14 x 14 Flr. Tom.....	<b>209.99</b>
<b>SKBD1416</b> 14 x 16 Flr. Tom.....	<b>213.99</b>
<b>SKBD1616</b> 16 x 16 Flr. Tom.....	<b>225.99</b>
<b>SKBD1618</b> 16 x 18 Flr. Tom.....	<b>240.99</b>
<b>SKBDM1420</b> 14 x 20 Marching Band Drum.....	<b>264.99</b>
<b>SKBD1620</b> 16 x 20 Bass Drum.....	<b>335.99</b>
<b>SKBD1622</b> 16 x 22 Bass Drum.....	<b>372.99</b>
<b>SKBD1624</b> 16 x 24 Bass Drum.....	<b>382.99</b>
<b>SKBD1626</b> 16 x 26 Bass Drum.....	<b>403.99</b>
<b>SKBD1820</b> 18 x 20 Bass Drum.....	<b>377.99</b>
<b>SKBD1822</b> 18 x 22 Bass Drum.....	<b>393.99</b>
<b>SKBD1824</b> 18" x 24" Bass Drum.....	<b>416.99</b>
<b>SKBD5514</b> 5½ x 14 Snare.....	<b>164.99</b>
<b>SKBD6514</b> 6½ x 14 Snare.....	<b>164.99</b>
<b>SKBCAST</b> Bass Drum Case Caster Kit.....	<b>224.99</b>
<b>SKBD0922</b> Steel Drum.....	<b>259.99</b>
<b>SKBDRP1</b> Drum Set Pack – Includes SKBD1822, SKBD1012, SKBD1214.....	<b>709.99</b>
<b>SKBDRP2</b> Drum Set Pack – Includes SKBD1822, SKBD1012, SKBD1616.....	<b>739.99</b>
<b>SKBDRP3</b> Drum Set Pack – Includes SKBD1620, SKBD1012, SKBD1616.....	<b>729.99</b>
<b>SKBDRP4</b> Drum Set Pack – Includes SKBD1824, SKBD1012, SKBD1616.....	<b>769.99</b>

## ETHNIC PERCUSSION DRUM BAGS



<b>KJEMSM</b> Djembe 12", Kaces.....	<b>\$70.30</b>
<b>KJEMMD</b> Djembe 14", Kaces.....	<b>77.05</b>
<b>KJEMLG</b> Djembe 16", Kaces.....	<b>84.30</b>
<b>KPC2</b> Cajon 21" x 13" x 11", Kaces, Heavy Duty Padding.....	<b>74.10</b>
<b>DJ310</b> Djembe 10", TKL.....	<b>116.80</b>
<b>DJ312</b> Djembe 12", TKL.....	<b>116.80</b>
<b>DJ314</b> Djembe 14", TKL.....	<b>116.80</b>
<b>DJ316</b> Djembe 16", TKL.....	<b>116.80</b>
<b>DJ318</b> Djembe 18", TKL.....	<b>116.80</b>
<b>DK310</b> Doumbek 18 x 9", TKL.....	<b>97.80</b>
<b>FD316</b> 16" Frame Drum, TKL.....	<b>72.80</b>
<b>DJ0012BG</b> 10"/12" Djembe, Remo.....	<b>85.30</b>
<b>DJ0014BG</b> 13"/14" Djembe, Remo.....	<b>98.20</b>

## SKB BAGS



<b>SKBCB22</b> 22" Cymbal.....	<b>\$130.99</b>
<b>SKBDBS1</b> Drum Set 10T, 12T, 14T, 14S, 22B.....	<b>251.99</b>
<b>SKBDBS2</b> Drum Set 12T, 13T, 14S, 16F, 22B.....	<b>251.99</b>
<b>SKBDBS3</b> Drum Set 10T, 12T, 14T, 14S, 20B.....	<b>251.99</b>
<b>SKBDB0808</b> 8" x 8" Tom.....	<b>36.99</b>
<b>SKBDB0910</b> 9" x 10" Tom.....	<b>36.99</b>
<b>SKBDB1012</b> 10" x 12" Tom.....	<b>41.99</b>
<b>SKBDB1113</b> 11" x 13" Tom.....	<b>41.99</b>
<b>SKBDB1214</b> 12" x 14" Tom.....	<b>46.99</b>
<b>SKBDB1416</b> 14" x 16" Tom.....	<b>62.99</b>
<b>SKBDB6513</b> 6.5" x 13" Snare.....	<b>41.99</b>
<b>SKBDB5514</b> 5.5" x 14" Snare.....	<b>46.99</b>
<b>SKBDB6514</b> 6.5" x 14" Snare.....	<b>51.99</b>
<b>SKBDB1414</b> 14" x 14" Floor Tom.....	<b>51.99</b>
<b>SKBDB1616</b> 16" x 16" Floor Tom.....	<b>62.99</b>
<b>SKBDB1618</b> 16" x 18" Floor Tom.....	<b>78.99</b>
<b>SKBDB1620</b> 16" x 20" Bass Drum.....	<b>88.99</b>
<b>SKBDB1622</b> 16" x 22" Bass Drum.....	<b>99.99</b>
<b>SKBDB1820</b> 18" x 20" Bass Drum.....	<b>93.99</b>
<b>SKBDB1822</b> 18" x 22" Bass Drum.....	<b>99.99</b>
<b>SKBDB1824</b> 18" x 24" Bass Drum.....	<b>109.99</b>

# ELITE PRO 3 AND PRO 4 BAGS



## PRO 3X CORDURA BAGS

UPBBE0414	4 x 14.....	\$44.75
UPBBE0513	5.5 x 13.....	45.50
UPBBE0514	5.5 x 14.....	51.25
UPBBE0614	6.5 x 14.....	57.25
UPBBE0808	8 x 8.....	42.25
UPBBE0810	8 x 10.....	44.75
UPBBE0812	8 x 12.....	48.75
UPBBE0814	8 x 14.....	52.25
UPBBE0910	9 x 10.....	47.50
UPBBE0913	9 x 13.....	52.25
UPBBE1010	10 x 10.....	51.75
UPBBE1112	11 x 12.....	55.75
UPBBE1213	12 x 13.....	59.25
UPBBE1214	12 x 14.....	60.50
UPBBE1414	14 x 14.....	64.75
UPBBE1415	14 x 15.....	66.75
UPBBE1416	14 x 16.....	77.50
UPBBE1418B	14 x 18.....	80.75
UPBBE1420	14 x 20.....	84.75
UPBBE1422	14 x 22.....	87.50
UPBBE1616	16 x 16.....	78.95
UPBBE1618	16 x 18.....	79.95
UPBBE1618B	16 x 18.....	94.85
UPBBE1620	16 x 20.....	99.00
UPBBE1622	16 x 22.....	103.00
UPBBE1624	16 x 24.....	105.00
UPBBE1820	18 x 20.....	103.75
UPBBE1822	18 x 22.....	105.75



## PRO 3 CORDURA BAG SETS

**STANDARD BAG SET**  
**UPBSU** .....\$284.00  
 Sizes: 11 x 12, 12 x 13, 16 x 16, 5.5 x 14, 16 x 22

**FUSION BAG SET**  
**UPBSUFSN** .....\$265.95  
 Sizes: 9 x 10, 11 x 12, 12 x 14, 6.5 x 14, 18 x 22

## PRO 4 NYLON BAG SETS

**STANDARD BAG SET**  
**DMC500** .....\$99.50  
 Sizes: 11 x 12, 12 x 13, 16 x 16, 5.5 x 14, 16 x 22

**FUSION BAG SET**  
**DMC500FSN** .....\$99.50  
 Sizes: 9 x 10, 11 x 12, 12 x 14, 6.5 x 14, 18 x 22



## PRO 3 CORDURA STICK BAGS

**UPNSB3** 6 Pairs .....\$19.50  
**UPNSB4** 6+ Pairs.....\$25.75

## PRO 3 CORDURA CYMBAL BAGS

**UPCYMBAG** .....\$48.50  
**UPCYMBAGD** Deluxe.....\$92.25

## PRO 3 CORDURA HARDWARE

**BAGS WITH WHEELS**  
**UPDHB25** 25" .....\$115.75  
**UPDHB36** 36" .....\$125.50  
**UPDHB47** 47" .....\$141.75

## DUST COVER

**UPDSC** Single Bass Drum Set.....\$83.95

# KACES PERCUSSION BAGS

## HARDWARE BAGS

Cordura Quality Outer Shell  
 Heavy Duty Zippers  
 2 End & 1 Side Zippered Pockets  
 Interior Straps To Secure Hardware  
 Tough, Tear Resistant Interior Lining  
 2 End Handle Padded Straps  
 Center Strap w/Quilted Pad  
 Padded Shoulder Strap  
 Rigid Bottom Section



**KPHD38W** 38" w/Wheels.....\$134.50  
**KPHD46W** 46" w/Wheels.....\$152.35

## DRUM BAG PREPACKS

### Nylon Drum Gig Bags

**KZDS1** Standard 10x12, 11x13, 16x16, 18x22, 6.5x14 .....\$257.50

# TKL PERCUSSION BAGS

<b>B4677SET</b>	5 pc. Black Drum Bag Set, 6½ x 14, 11 x 12, 12 x 13, 16 x 16, 16 x 22.....	\$227.00
<b>B4670</b>	6½ x 14 Black Drum Bag.....	45.30
<b>B4671</b>	11 x 12 Black Drum Bag.....	49.10
<b>B4672</b>	12 x 13 Black Drum Bag.....	52.80
<b>B4673</b>	16 x 16 Black Drum Bag.....	64.20
<b>B4674</b>	16 x 22 Black Drum Bag.....	79.20
<b>B4680</b>	Drum Stick Bag.....	22.55
<b>B4780</b>	DLX Drum Stick Bag.....	33.95
<b>B4781</b>	DLX Bongo Bag.....	71.75
<b>B4784</b>	DLX Large Conga Bag.....	94.45
<b>B4785</b>	DLX Cymbal Bag.....	68.00
<b>B4786</b>	33" Accessory Bag.....	83.15
<b>CD30OKIT</b>	5 Pc Drum Bag Set, Coda w/Stick Bag.....	181.40



# ON/STAGE



**DHB6500** Drum Hardware Bag.....\$339.99

This rugged heavy-duty hardware bag features two rollerblade-style wheels and a reinforced handle for handcart-style portability. Constructed from a heavy-duty nylon material, the bag is lined with foam padding to protect your equipment. It features a front accessories pocket, a top compartment sized to fit a drum throne seat, a collapsible interior vinyl compartment divider, and an extra wide double-pull zipper. Holds up to 8 pieces of hardware. Dimensions: 38 x 14 x 10". Weight Capacity: 100 lbs. Color: Black.



**CBT4200D** Deluxe Cymbal Bag with Trolley.....\$140.99 ea.

It holds a total of 8 cymbals (5 inside pocket, 3 outside pocket), the largest up to 22" in diameter. Interior foam dividers separate your cymbals and provide extra protection and support.



**DA100** Clamp-On Drum Stick Holder ...\$29.99 ea.

Keep up to 8 pairs of sticks conveniently within reach. The DA-100's C-shape mounting clamp attaches easily to most stands or other hardware. Its extension arm is angled downward at 45° for easy removal and placement of sticks while playing.

# DRUM PADS



**REMO DRUM PADS**

RT0006	6" Tunable.....	\$28.60
RT0008	8" Tunable.....	\$33.60
RT0010	10" Tunable.....	\$45.20
ST1000	Pad Stand.....	\$72.70
UPCPS	Pad Stand.....	\$58.85
3650STD	Pad Stand.....	\$44.60
UPCPS8MM	Pad Stand 8mm mount.....	\$48.95



**REMO PADS & STANDS**

RT0006ST	.....	\$100.40
RT0008ST	.....	\$102.10
RT0010ST	.....	\$109.70

**PRACTICE PAD KIT**  
8" tunable pad. Wide tripod base with extended height stand. Nylon backpack bag. Drum sticks.  
**3650** .....\$105.05



Perfect for warm up!

Great for beginners!

**GO ANYWHERE™ PRACTICE KIT**  
Portable 5-piece pad set. Natural feel and rebound. Allows for ultra-quiet practice. Heavy-duty construction. 8" add-on available. Easy setup. Complete Go Anywhere™ Practice Kit includes two 8" pads for tom and cymbal, two 10" pads for snare and floor tom, one bass drum pad, stand and all mounting hardware (pedal not included)  
**DWCPPADT55** ..... \$283.99B

**THE MIKE JOHNSON GHOST NOTE PRO PRACTICE PAD**  
An adjustable Dynamic Control Bar allows students to practice their grace notes at determined heights. The bar can be placed on either side of the pad to suit right or left-handed players and to challenge either hand. The specially-formulated rubber has just the right amount of rebound and the pad can be mounted via a snare stand, cymbal stand, table top, snare drum top or Go Anywhere practice kit. To see Mike demo the Ghost Note Pro, check out [www.dwdrums.com](http://www.dwdrums.com).  
**DWPADMJ** Ghost Note Pro Practice Pad.....\$66.99B

**PUTTY PAD**  
**RT100152** .....\$15.50

**DRUM PAD/HEADS**

4289	6" Tunable.....	\$20.90
4290	8" Tunable.....	\$24.75
4290RH	8" Head only.....	\$7.05
PH0106	6" Head only.....	\$13.10B
PH0108	8" Head only.....	\$13.80B
PH0110	10" Head only.....	\$14.40B

**GRAFIX PADS**  
6 Inch Rubber Pad.....\$26.70

GXPAD45	45 RPM
GXPADCK	Checkboard
GXPADTG	Target
GXPADSH	Skull Hat
GXPADHZ	Hazard
GXPADD8	Skull

**VIC FIRTH**  
**V200** 8" Tunable Pad ....\$29.65



**WOOD BASE**

UPCPPL	Large.....	\$17.50
4140	Medium.....	\$12.55
3561	6 1/4 X 4 3/4 .....	\$10.00

**RUBBER**  
5" Dia., Angled, Hard Rubber Drum Pad  
**4286** Rebounder.....\$12.45  
**4289** 6" .....\$20.90

**REGAL TIP**  
**351P** 4" Rubber Pad .....\$15.00

**GLADSTONE STYLE**

4288	KDS .....	\$15.85
4280	KDS 13" Pad .....	\$16.05
UPPP1	Cannon .....	\$20.00

**HQ PERCUSSION**

RF6GM	6" mountable .....	\$30.99
RF6D	6" double sided .....	\$34.99
RF12G	12" single sided .....	\$49.99
RF12D	12" double sided.....	\$59.99
RFBASS	Pedal pad.....	\$109.00

**EVANS PRACTICE PAD**  
**ARF7GM** 7" Apprentice 8mm Mountable Pad.....\$30.79

**CANNON KNEE PRACTICE PAD**  
**UPNEEBK** Black.....\$27.50B

**GIBRALTAR PRACTICE PAD**  
**SCLPP** Knee Practice Pad w/strap.....\$41.40

**REMO BRUSH UP PAD**  
14" Head mounted in a foam backed rim.  
**RT0014** .....\$53.10

**ZILDJIAN**

P1201	6" Mountable .....	\$32.95
P1202	12" Mountable.....	\$52.95
P1204	6" Travis Barker .....	\$36.95
P1205	12" Travis Barker .....	\$58.95
P1206	6" Joey Kramer Mountable .....	\$36.95
TREDP1	6" Tre Cool .....	\$36.95
TREDP2	12" Tre Cool .....	\$58.95

**RHYTHM TECH**  
Laptop practice snare  
**RT7600** .....\$100.95

**VIC FIRTH**

VFPAD6	Single Sided.....	\$36.00
VFPAD6D	Double Sided.....	\$42.00
VFPAD12	Single Sided.....	\$57.75
VFPAD12D	Double Sided.....	\$68.25
VFPAD12H	Half & Half .....	\$68.25

**INNOVATIVE**

RP1	Two-sided Pad .....	\$61.00
RP1S	Single-sided Snare .....	\$80.00B
CP1	Single-sided Corps .....	\$56.00B
RPTI	Practice Tips (3 pr.) .....	\$9.00 pk.

**AQUARIAN**

AQTBP12	True Bounce.....	\$49.00
AQBP6	Quik Bounce .....	\$35.00



HQ



UPNEEBK



VFPAD6D/12D



**VIC FIRTH HEAVY HITTER PADS**

VFHHPST	Stock Pad .....	\$54.00B
VFHHPSL	Slim Pad .....	\$51.75B
VFHHPPE	Exacto Pad .....	\$54.00B
VFHHPQS	Quadro Pad, Small .....	\$203.00B
VFHHPQL	Quadro Pad, Large.....	\$215.00B
VFHHPBASS	Marching Bass Pad.....	\$105.00B

**LAMINATES**  
**VFHHPSNL** Snare, 1-10.5" .....\$16.80B



# REGAL TIP



## REGAL TIP

**WOOD** .....\$15.00 pr.

- RT2BW 16" heavy
- RT3AW 15½" medium
- RT5AW 16" medium
- RT5BW 16" medium heavy
- RT7AW 15" light
- RT7BW 15½" light
- RT8AW 16" light jazz
- RT9AW 16" light
- RTJAZZW 16" medium
- RTROCKW 16" medium
- RTPINGW Ping
- RTSESW Session

**NYLON** .....\$15.50 pr.

- RT5BN 16" medium heavy
- RTJCN 16" medium
- RTJAZZN 16" medium
- RTROCKN 16" medium
- RTCOMBON 16" thin
- RT2BN 16" heavy
- RT3AN 15½" medium
- RT5AN 16" medium
- RT3BN 16¾" heavy neck
- RT7AN 15" light



## GOODMAN MALLETS

- 601SG Hard Mallets.....\$59.00
- 602SG Normal Staccato.....\$59.00
- 603SG General All Purpose.....\$59.00
- 605SG Green Ultra Staccato...\$59.00
- 606SG Cart Wheel Model.....\$59.00
- 604SG Wood Ball.....\$34.00

## EX SERIES

- RTSPDEX Speed Ex Nylon Tip.....\$16.25
- RTDTHEX Death Ex Nylon Tip.....\$16.25
- RTGRDEX Grind Ex Nylon Tip.....\$16.25

## X SERIES

### WOOD TIP

- RTX5AW .....\$15.00
- RTXJAZZW .....\$15.00
- RTANXW Anarchy.....\$15.00



### RTTHTKO

## PERFORMERS SERIES

**WOOD TIP** .....\$16.75 pr.

- |                               |                            |
|-------------------------------|----------------------------|
| RTJS Jason Sutter             | RTDAW Daniel Adair         |
| RTCTW Chester Thompson        | RTGRW C. Bisquera Groovers |
| RTAVH Alex Van Halen          | RTBG Bob Gatzen            |
| RTWRJ Wilfredo Reyes Jr.      | RTJHW Jeff Hamilton        |
| RTTC313W Tommy Clufetos       | RTTHTKO Takuh Hirano       |
| RTJHN (Nylon Tip), Jake Hanna | w/Grip .....\$38.00        |

## BRIAN TICHY (TISH)



RTPFBT.....\$16.75 pr.

## CYMBAL MALLETS

- RTH1 Hard Felt.....\$45.00 pr.
- RNBSTEX Blast Mallet Ex.....\$59.00 pr.

## TIMBALE STICKS

- 12RTTS ½", 4 pr./pack .....\$34.00
- 38RTTS ¾", 4 pr./pack .....\$34.00
- 716RTTS 7/16", 4 pr./pack .....\$34.00

## BRUSHES

- 590R Jason Sutter.....\$43.00
- 523P Wave Cajon Brush.....\$39.00
- 522P Swish Cajon Brush.....\$39.00
- 593C Clayton Cameron Brush.....\$46.00
- 594P Ed Thigpen Brush.....\$33.00
- 532R Flares Brush.....\$33.00
- 531R Brush Stick, Hickory Handle, Blasticks.....\$35.00
- 530R Brush Stick, Plastic Handle, Blasticks.....\$35.00
- 505YJ Rubber Handle, Throw.....\$30.00
- 565FC Fat Cat Nylon Brushes.....\$36.00
- 582RJR John Robinson Brushes.....\$43.00
- 575YJ Rubber Handle, Push Pull.....\$31.00

## EX MALLET

RTMYHMEX Mayhem Ex Mallet .....\$49.00 pr.

www.regaltip.com

## ROAD SERIES

Economically Priced Hickory Sticks

**NYLON** .....\$5.85 pr.

**WOOD** .....\$5.85 pr.

- |          |         |
|----------|---------|
| RS5AN    | RS5AW   |
| RSROCKN  | RSROCKW |
| RS2BN    | RS2BW   |
| RS5BN    | RS5BW   |
| RSQ3000N |         |

## QUANTUM

**WOOD**.....\$16.75 pr.

Q1000W Rock size shaft

Q3000W 16", 5B size shaft

**NYLON** .....\$17.25 pr.

Q1000N 16" Rock size shaft

Q3000N 16", 5B size shaft

## CONGA STICKS

542L.....\$57.00 pr.

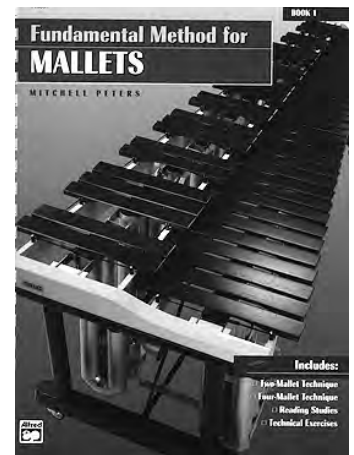

Fundamental Method For Mallets  
M. Peters .....\$26.95

**WE STOCK INSTRUCTIONAL METHOD BOOKS  
AND DVD'S FOR THE PERCUSSIONIST**

# VIC FIRTH

## AMERICAN CLASSIC



<b>HICKORY WOOD TIP</b>	
VF1AW	\$15.25
VF3AW	15.25
VF5AW	15.25
VF5AWW	White 15.25
VF5API	Pink 15.25
VF5ABW	Black Finish 15.25
VFX5AW	Extreme 15.25
VF55A	5A/5B Combo 15.25
VFX55A	Extreme 15.25
VF7AW	15.25
VFESTICK	E Stick 15.25
VFF1	Fusion 15.25
VF2BW	15.25
VF5BW	15.25
VF5BWW	White 15.25
VF5BBW	Black Finish 15.25
VFX5BW	Extreme 15.25
VFX55B	Extreme .610 15.25
VF8DW	15.25
VFRockW	15.25
VFX8D	Extreme 15.25
VF85A	8D/5A Combo 15.25
VFCMW	Classic Metal 15.25
VFRockW	15.25

## AMERICAN CLASSIC

<b>HICKORY NYLON TIP</b>	
VF5AN	\$15.75
VF7AN	15.75
VF2BN	15.75
VF5BN	15.75
VF8DN	15.75
VFRock N	15.75
VFCMN	Classic Metal 15.75
VF3AN	15.75
VFX5AN	Extreme 5A 15.75
VFX5BN	Extreme 5B 15.75

## KIDS STICKS

VFKIDS	Blue	\$10.25 pr.
VFKIDSPI	Pink	10.25 pr.
Age 3 to 8 - 13" long		

## AMERICAN CLASSIC W/GRIP

<b>WOOD TIP</b>	
VF5AWVG	Vic Grip \$19.45
VF5BWVG	Vic Grip 19.45
VF7AWVG	Vic Grip 19.45
VF2BWVG	Vic Grip 19.45
VFRockWVG	Vic Grip 19.45
VFX5AWVG	Extreme Vic Grip 19.45
VFX5BWVG	Extreme Vic Grip 19.45

## AMERICAN CLASSIC W/GRIP

<b>NYLON TIP</b>	
VFX5ANVG	Extreme Vic Grip \$19.95
VFX5BNVG	Extreme Vic Grip 19.95
VF5ANVG	Vic Grip 19.95
VF5BNVG	Vic Grip 19.95
VF7ANVG	Vic Grip 19.95
VF2BNVG	Vic Grip 19.95
VFRockNVG	Vic Grip 19.95

## AMERICAN CLASSIC

<b>SPECIALTY STICKS</b>	
VF5ASB	Aluminum Tip (Silver) \$19.95
VF5BSB	Aluminum Tip (Silver) Bullet 19.95
VF5AST	Felt Tip - Soft Touch 19.95
VF5BST	Felt Tip - Soft Touch 19.95
VF5AWKF	Kinetic Force 22.60
VF5BWKF	Kinetic Force 22.60
VF5ADJ	Dual Tone 33.60
VF5BCO	Chop Out Rubber Tip 17.85

## AMERICAN CUSTOM



<b>MAPLE</b>	
VFSD1	General Snare \$15.25
VFSD1JR	General Jr. (Red) 15.25
VFSD2	Bolero Snare 15.25
VFSD4	Combo Snare 15.25
VFSD5	Echo 15.25
VFSD6	Swizzle B Snare 36.75
VFSD7	Whacker Snare 15.75
VFSD9	Driver Snare 15.25
VFSD10	Swinger Snare 15.25
VFSD11	Slammer 15.25
VFSD12	Swizzle G Snare 36.75
VFHD4	Hickory SD4 15.25
VFHD9	Hickory SD9 15.25

## AMERICAN HERITAGE®



<b>WOOD TIP, MAPLE</b>	
VFAH5AW	\$15.25 pr.
VFAH5BW	15.25 pr.
VFAH7AW	15.25 pr.

## AMERICAN SOUND

<b>WOOD TIP, MAPLE</b>	
VFA5A	Wood Tip \$15.25
VFA5B	Wood Tip 15.25
VFA57A	Wood Tip 15.25
VFA58D	Wood Tip 15.25

## AMERICAN JAZZ®

<b>WOOD TIP, HICKORY</b>	
VFAJ1	\$15.25 pr.
VFAJ2	15.25 pr.
VFAJ3	15.25 pr.
VFAJ4	15.25 pr.
VFAJ5	15.25 pr.
VFAJ6	15.25 pr.

## SHOGUN JAPANESE WHITE OAK

VFSHO5AW	\$19.95
VFSHO5BW	19.95

## CARBON FIBER STICKS "TITAN"

VFT15B	\$99.95
--------	---------

## NOVA DRUM STICKS

<b>HICKORY WOOD TIP</b>	
N2BW	\$6.55
N5AW	6.55
N5BW	6.55
N7AW	6.55
NROCKW	6.55

## HICKORY NYLON TIP

N2BN	7.10
N5AN	7.10
N5BN	7.10
N7AN	7.10
NROCKN	7.10

## WORLD CLASSICS

VFACUNA	Acuna Timbale, 7/16", Red \$10.75
VFALEX	Acuna Timbale, 1/2", Purple 10.75
VFABSB1	Street Beat 1 35.00 pr. B
VFABSB2	Street Beat 2 40.00 pr. B
VFTMB1	Timbale Sticks 9.00 pr. B
VFTMB2	Timbale Sticks 9.00 pr. B

## SIGNATURE SERIES



VFAPPICE	Carmen Appice	\$17.35
VFSBEA	Carter Beauford <b>Yellow Grip</b>	21.55
VFSBEN	Charlie Benante	21.55
VFBISS	Greg Bissonette	17.35
VFSGB2	Greg Bissonette (Back Beat)	21.55
VFSCB	Cindy Blackman	17.35
VFSTB1	Terry Bozzio, Phase 1	17.35
VFCAMERON	Matt Cameron	17.35
VFSDC	Danny Carey	17.35
VFSDCN	Danny Carey, Nylon	17.85
VFCOBH	Billy Cobham, Hickory	17.35
VFSVC	Vinnie Colaiuta, Wood Tip	17.35
VFDEJOHN	Jack De Johnette, Wood	17.35
VFSJDN	Jack De Johnette, Nylon	17.85
VFSDOL	John Dolmayan	17.35
VFERSKINE	Peter Erskine	17.35
VFE2	Peter Erskine Ride Stick	17.35
VFSPE3	Peter Erskine Big Band	17.35
VFGADD	Steve Gadd	17.35
VFGADDN	Steve Gadd, Nylon	17.35
VFSGRE	Matt Greiner	17.35
VFSHA	Tomas Haake	17.35
VFHAKIM	Omar Hakim (Nylon)	17.85
VFSHAR	Gavin Harrison <b>Blue Grip</b>	21.55
VFSJH	Joey Heredia	17.35
VFSGH	Gerald Heyward	17.35
VFSTI	Tommy Igoe	17.35
VFSJOR	Steve Jordan	17.35
VFSGK	George Kollias	17.35
VFSAL	Abe Laboriel Jr.	17.35
VFSTL	Thomas Lang, Wood Tip	17.35
VFSPL	Paul Leim	17.35
VFSHM3	Harvey Mason "The Chameleon"	17.35
VFSNM	Nicko McBrain	17.35
VFSMIL	Russ Miller	17.35
VFSSM	Stanton Moore	17.35
VFROD	Rod Morgenstein	17.35
VFSVP	Vinnie Paul	17.35
VFSMR	Marky Ramone	17.35
VFRICH	Buddy Rich	17.35
VFROYSTER	Tony Royster, Jr.	17.35
VFSCS	Christoph Schneider	17.35
VFSMITH	Steve Smith	17.35
VFSAS	Aaron Spears	17.35
VFSMT	Mike Terrana	17.35
VFSAT	Ahmir Thompson ?uest Love	21.55
VFWATTS	Charlie Watts	17.35
VFWECKL	Dave Weckl	17.35
VFWECKLN	Dave Weckl, Nylon	17.85
VFSDW2	Dave Weckl Evolution	17.35
VFSLW	Lenny White	17.35
VFSSW	Steve White	17.35
VFSZ	Zoro	17.35
VFPP	Power Play Kenny Aronoff	17.35
VFJM	Jam Master David Garibaldi	17.35
VFJIMBO	Akira Jimbo	17.35
VFGONZALEZ	Alex Gonzalez	17.85
VFMAYER	Jojo Mayer	17.35
VFSKC	Keith Carlock	17.35

## GONG MALLETS/ CHIME HAMMER



VFGB1	Large Mallet	\$82.50
VFRGB1	Replacement Felts for VFGB1	12.75
VFGB2	Small Mallet	75.60
VFGB3	Large/Heavy	72.45
VFGB4	Medium/Heavy	75.60
VFCH	PVC Head, Chime Hammer	38.85
<b>CYMBAL STICKS</b>		
VFBCS1	Soft Yarn, Becken	\$47.00 pr. B

# VIC FIRTH

## AMERICAN CUSTOM KEYBOARD MALLET



### YARN WOUND – BIRCH

VFM1	Soft Head – Round.....	\$46.75B pr.
VFM2	Medium Head – Round.....	46.75B pr.
VFM3	Medium Head – Mushroom.....	46.75B pr.
VFM4	Super Soft Head – Round.....	46.75B pr.

### UNWOUND – BIRCH

VFM5	Medium Rubber.....	\$31.20B pr.
VFM6	Hard Phenolic – 1" Ball.....	31.20B pr.
VFM7	Hard Phenolic – 1½".....	31.20B pr.
VFM11	Brass Head Bells.....	34.00B pr.
VFM14	Polycarbonate (Xylophone).....	30.25B pr.

### CORD WOUND – BIRCH

VFM10	Very Hard Head – Round.....	\$46.75B pr.
-------	-----------------------------	--------------

### ORCHESTRAL SERIES XYLOPHONE – RATTAN

VFM130	Soft Plastic.....	\$53.60B pr.
VFM131	Medium Soft Rubber.....	53.60B pr.
VFM132	Medium Rubber.....	42.25B pr.
VFM133	Medium Poly.....	43.25B pr.
VFM134	Medium Hard Urethane.....	53.55B pr.
VFM135	Hard PVC.....	44.30B pr.
VFM136	Hard Acetal.....	55.65B pr.
VFM137	Medium Hard Teflon®.....	55.65B pr.
VFM138	Medium Poly.....	55.65B pr.
VFM139	Hard Lexan®.....	61.80B pr.

### BELLS – RATTAN

VFM140	Medium Nylon.....	\$43.00B pr.
VFM141	Medium Hard nylon.....	43.00B pr.
VFM142	Very Hard Phenolic.....	38.00B pr.
VFM143	Hard Acetyl.....	38.00B pr.
VFM144	Brass.....	38.00B pr.
VFM145	Brass (Oval).....	40.00B pr.
VFM146	Aluminum.....	38.00B pr.

### VIRTUOSO – SOLO MARIMBA – BIRCH

VFM210	Soft, Yarn Wound.....	\$51.45B pr.
VFM211	Medium Soft, Yarn Wound.....	51.45B pr.
VFM212	Medium, Yarn Wound.....	51.45B pr.
VFM213	Medium Hard, Yarn Wound.....	51.45B pr.
VFM214	Hard, Yarn Wound.....	51.45B pr.

### ENSEMBLE SERIES – RUBBER CORE/LATEX COVER – RATTAN

VFM150	Bass Marimba.....	\$59.00B pr.
VFM151	Soft Mallets.....	49.00B pr.
VFM152	Medium Soft Mallets.....	49.00B pr.
VFM153	Medium Mallets.....	49.00B pr.
VFM154	Medium Hard Mallets.....	49.00B pr.
VFM155	Hard Mallets.....	54.00B pr.

### PESANTE SERIES

#### MARIMBA – RATTAN

VFM201	Soft – Yarn.....	\$63.90B
VFM202	Medium Soft – Yarn.....	63.90B
VFM203	Medium Hard – Yarn.....	63.90B
VFM204	Hard – Yarn.....	63.90B
VFM205	Soft – Cord.....	63.90B
VFM206	Medium Soft – Cord.....	63.90B
VFM207	Medium Hard – Cord.....	63.90B
VFM208	Hard – Cord.....	63.90B

## SIGNATURE SERIES

### WOUND

VFM31	Medium, Blue Cord – Terry Gibbs.....	\$67.20B pr.
VFM32	Medium Hard, Green Cord – Terry Gibbs.....	67.20B pr.
VFM33	Hard, Red Cord – Terry Gibbs.....	67.20B pr.
VFM36	Stefon Harris – Yarn/Rattan.....	71.40B pr.
VFM38	Ed Saindon – Cord/Rattan.....	73.60B pr.
VFM23	Medium Hard Cord/Rattan – Victor Mendoza.....	56.70B pr.
VFM25	Gary Burton – Yarn/Rattan.....	56.70B pr.

## AMERICAN CUSTOM TIMPANI MALLET



Vic Firth timpani mallets are turned from hand selected rock maple.

VFT1	General.....	\$51.45 pr.
VFT2	Cartwheel.....	51.45 pr.
VFT3	Staccato.....	51.45 pr.
VFT4	Ultra Staccato.....	46.00 pr.
VFT5	Wood.....	27.85 pr.
VFT6	Custom General.....	52.50 pr.

### ACCESSORIES

VFRT1	General Felt Recover.....	\$13.40 pr.
VFRT2	Cartwheel Recover.....	18.90 pr.
VFRT3	Staccato Felt Recover.....	13.40 pr.
VFRT4	Staccato Recover.....	13.40 pr.
VFRT6	Custom General Recover.....	13.40 pr.

### TIM GENIS SIGNATURE TIMPANI MALLET

VFGEN1	Roller.....	\$95.55 Pr.
VFGEN2	Soft Beethoven.....	75.60 Pr.
VFGEN3	Hard Beethoven.....	73.50 Pr.
VFGEN4	Dolce Beethoven.....	95.80 Pr.
VFGEN5	Tonal.....	65.65 Pr.
VFGEN6	Hard Tonal.....	60.10 Pr.
VFGEN7	Articulate.....	61.15 Pr.
VFGEN8	Molto Articulate.....	64.60 Pr.

### GIFFORD HOWARTH SIGNATURE MARIMBA MALLET – BIRCH

VFM160	Very Soft Mallets.....	\$49.35B pr.
VFM161	Soft Mallets.....	48.30B pr.
VFM162	Medium Mallets.....	43.05B pr.
VFM163	Medium Hard Mallets.....	43.05B pr.
VFM164	Multi Mallets.....	45.15B pr.

### ROBERT VAN SICE SIGNATURE RUBBER CORE MARIMBA MALLET

VFM111	Very Soft.....	\$60.90B pr.
VFM112	Soft, Dark.....	60.90B pr.
VFM113	Medium Soft.....	60.90B pr.
VFM114	Medium.....	60.90B pr.
VFM115	Medium Hard, Bright.....	60.90B pr.
VFM116	Hard, Very Bright.....	60.90B pr.

### ROBERT VAN SICE SIGNATURE SYNTHETIC CORE MARIMBA MALLET

VFM121	Very Soft.....	\$60.90B
VFM122	Soft.....	60.90B
VFM123	Medium Soft.....	60.90B
VFM124	Medium.....	60.90B
VFM125	Medium Hard.....	60.90B
VFM126	Hard.....	60.90B

### NEY ROSAURO SIGNATURE KEYBOARD MALLET

#### MARIMBA

VFM221	Soft.....	\$65.28B
VFM222	Medium Soft.....	59.16B
VFM223	Medium Hard.....	59.16B
VFM224	Hard.....	59.16B

#### VIBRAPHONE

VFM225	Ney Rosauro Keyboard – Soft.....	\$67.35B
VFM226	Ney Rosauro Keyboard – Medium.....	67.35B
VFM227	Ney Rosauro Keyboard – Hard.....	67.35B

#### HYBRID

VFM228	Ney Rosauro Keyboard – General.....	\$67.35B
--------	-------------------------------------	----------

www.vicfirth.com

# VIC FIRTH

## CONCERT SNARE STICKS

<b>VFSTG</b>	General Snare Sticks, Tim Genis.....	<b>\$18.40 pr.</b>
<b>VFSTG2</b>	Leggiero Snare, Tim Genis.....	<b>18.40 pr.</b>
<b>VFSATK</b>	Atkatz Snare Sticks.....	<b>18.40 pr.</b>

## TOM GAUGER SNARE STICKS

<b>VFTG15</b>	Maple, Wood Tip, General.....	<b>\$17.35 pr.</b>
<b>VFTG25</b>	VFTG15 and Timpani Mallet End.....	<b>50.40B pr.</b>



## CONCERT BASS DRUM MALLETS

Round felt heads for a deep, dark sound.

<b>VFBD1</b>	General, 3 1/4" Head, 17" Length.....	<b>\$54.60 ea.</b>
<b>VFBD2</b>	Legato, 3 1/4" Head, 17 1/2" Length.....	<b>59.05 ea.</b>
<b>VFBD3</b>	Staccato, 2 3/4" Head, 16 1/2" Length.....	<b>61.15 ea.</b>
<b>VFBD7</b>	Rollers, 2 3/4" Head, 16" Length.....	<b>83.50 pr.</b>
<b>VFBD8</b>	Sound Power.....	<b>81.90 ea.</b>

## REPLACEMENT FELTS

<b>VFRBD1</b>	.....	<b>\$18.90 ea.</b>
<b>VFRBD2</b>	.....	<b>18.90 ea.</b>
<b>VFRBD3</b>	.....	<b>13.40 ea.</b>
<b>VFRBD7</b>	.....	<b>18.90 ea.</b>

## TOM GAUGER SIGNATURE BASS DRUM SERIES

<b>VFTG01</b>	General Bass Drum.....	<b>\$68.25B ea.</b>
<b>VFTG02</b>	Dark Bass Drum.....	<b>73.00B ea.</b>
<b>VFTG03</b>	Oval Bass Drum.....	<b>72.45B ea.</b>
<b>VFTG04</b>	Rollers Bass Drum.....	<b>128.00B pr.</b>
<b>VFTG06</b>	Forto Bass Drum.....	<b>72.45B ea.</b>
<b>VFTG07</b>	Ult. Stac Bass Drum.....	<b>51.45B ea.</b>
<b>VFTG08</b>	Staccato Bass Drum.....	<b>61.95B ea.</b>
<b>VFTG21</b>	Chamois/Wood Bass Drum.....	<b>66.15B pr.</b>
<b>VFTG26</b>	Double End Bass Drum.....	<b>100.80B ea.</b>

## CORPSMASTER® MULTI-TENOR MALLETS

<b>VFMT1AS</b>	Nylon Head, X-Heavy Aluminum Shaft.....	<b>\$50.15 pr.</b>
<b>VFMT1A</b>	Nylon Head, Gold Aluminum Shaft.....	<b>46.75 pr.</b>
<b>VFMT2A</b>	X-Hard Felt Head, Gold Aluminum Shaft.....	<b>52.50 pr.</b>
<b>VFMT3A</b>	Soft Fleece Head, Gold Aluminum Shaft.....	<b>58.00 pr.</b>
<b>VFMT4A</b>	Nylon Cartwheel Head, Gold Aluminum Shaft.....	<b>46.75 pr.</b>
<b>VFMTT</b>	Nylon Head, Hickory Shaft.....	<b>39.10 pr.</b>

## CORPSMASTER® MARCHING BASS MALLETS

Feature tapered hickory shafts, spherical heads. With super hard felt heads (H) or with soft felt cores covered with fleece (S). L - 14 1/2".



1H 2H 3H 4H 1S 2S 3S 4S

## MARCHING BASS MALLETS - SOFT

<b>VFMB1S</b>	Small Head.....	<b>\$59.40 pr.</b>
<b>VFMB2S</b>	Medium Head.....	<b>63.00 pr.</b>
<b>VFMB3S</b>	Large Head.....	<b>70.15 pr.</b>
<b>VFMB4S</b>	X-Large Head.....	<b>78.00 pr.</b>

## MARCHING BASS MALLETS - HARD

<b>VFMB0H</b>	X-Small Head, 1 1/4".....	<b>\$53.62 pr.</b>
<b>VFMB1H</b>	Small Head, 1 1/2".....	<b>55.00 pr.</b>
<b>VFMB2H</b>	Medium Head, 1 3/4".....	<b>59.40 pr.</b>
<b>VFMB3H</b>	Large Head, 2".....	<b>70.15 pr.</b>
<b>VFMB4H</b>	X-Large Head, 2 1/4".....	<b>78.10 pr.</b>
<b>VFMB5H</b>	XX-Large Head, Hard.....	<b>88.00 pr.</b>

## EDUCATIONAL PACKS

<b>VFEP1</b>	.....	<b>\$94.00</b>
Contains: IPR VFSD1, VFM5, VFM14 and a Stick Bag		
<b>VFEP2</b>	.....	<b>151.20</b>
Contains: IPR VFSD2, VFM3, VFM6, VFT3 and a Stick Bag		
<b>VFLPAD</b>	.....	<b>59.45</b>
Contains: IPR VF5AW, Practice Pad and Vic's Snare Method		
<b>VF20818</b>	Firth/Alfred.....	<b>39.95B</b>
Contains: 1 Pr. Jay Wanamaker Sticks, 1 VF Pad, 1 Rudiment Book		
<b>VFFASP</b>	Education Pack.....	<b>50.30B</b>

## CORPSMASTER® SNARE STICKS



<b>VFMS1</b>	16 1/2" x .695.....	<b>\$16.30 pr.</b>
<b>VFMS2</b>	17" x .695.....	<b>16.30 pr.</b>
<b>VFMS3</b>	17" x .715.....	<b>15.50 pr.</b>
<b>VFMS4</b>	Magnum 16 1/4" x .685.....	<b>37.30 pr.</b>
<b>VFMS5</b>	Wood Tip 17" x .705.....	<b>16.30 pr.</b>
<b>VFMS6CO</b>	MS6 Chop Out.....	<b>32.00 pr.</b>
<b>VFAUNGST</b>	Tom Aungst.....	<b>18.40 pr.</b>
<b>VFSTA2</b>	Tom Aungst Indoor (Green).....	<b>18.40 pr.</b>
<b>VFSLB</b>	Lee Beddis.....	<b>18.40 pr.</b>
<b>VFFLOATW</b>	T. Float Wood.....	<b>18.40 pr.</b>
<b>VFSMG</b>	Gussek Drum & Bugle Corps.....	<b>18.40 pr.</b>
<b>VFHANNUM</b>	Thom Hannum.....	<b>18.40 pr.</b>
<b>VFSTH3</b>	T. Hannum, Piccolo Tip.....	<b>18.40 pr.</b>
<b>VFHARDIMON</b>	Ralph Hardimon, Wood Tip.....	<b>18.40 pr.</b>
<b>VFHARDN</b>	Ralph Hardimon, NylonTip.....	<b>19.95 pr.</b>
<b>VFRALPHIE</b>	Ralphie Jr.....	<b>18.40 pr.</b>
<b>VFSRH1</b>	Ralph Hardimon Indoor.....	<b>18.40 pr.</b>
<b>VFSRH2</b>	Ralph Hardimon Hammer.....	<b>38.60 pr.</b>
<b>VFSRH2CO</b>	Ralph Hardimon Chop Out.....	<b>48.30 pr.</b>
<b>VFSCM</b>	Colin McNutt.....	<b>18.40 pr.</b>
<b>VFSJQ</b>	Jeff Queen, Solo.....	<b>18.40 pr.</b>
<b>VFSMJ</b>	Mike Jackson.....	<b>18.40 pr.</b>



VFSJLL

## CORPSMASTER® "GROOVE" SERIES

<b>VFSJLL</b>	Johnny Lee Lane Groove Snare Stick.....	<b>\$18.40 pr.</b>
<b>VFGSTE</b>	Tenor Groove Mallets.....	<b>58.80B pr.</b>
<b>VFGSSC</b>	Scotch Groove Bass Drum Mallets.....	<b>60.90B pr.</b>
<b>VFGSTH</b>	Thunder Groove Bass Drum Mallets.....	<b>84.00B pr.</b>

## MARCHING TIMPANI STICKS

<b>VFCT1</b>	General.....	<b>\$50.15 pr.</b>
<b>VFCT3</b>	Staccato.....	<b>50.15 pr.</b>
<b>VFCT4</b>	Ultra Staccato.....	<b>50.15 pr.</b>

## MARCHING MULTI-TENOR MALLETS

<b>VFMTS1</b>	Tenor Sticks.....	<b>\$21.25 pr.</b>
<b>VFSRHTS</b>	Ralph Hardimon Tenor Sticks.....	<b>18.40 pr.</b>
<b>VFSTHTS</b>	Thom Hannum Multi Tenor Sticks.....	<b>18.40 pr.</b>
<b>VFSBBTS</b>	Bill Bachman Multi Tenor.....	<b>18.40 pr.</b>
<b>VFSRHTSW</b>	Hardimon/Swizzle Tenor.....	<b>44.65 pr.</b>
<b>VFMTS1SW</b>	Swizzle Tenor.....	<b>47.25 pr.</b>
<b>VFSTATH</b>	Tom Aungst Tenor Hybrid Nylon.....	<b>30.20 pr.</b>
<b>VFSTATHF</b>	Tom Aungst Tenor Hybrid Felt.....	<b>37.80 pr.</b>

## MARCHING KEYBOARD MALLETS

<b>VFM170</b>	S, Yarn, Rubber Core.....	<b>\$45.00B pr.</b>
<b>VFM171</b>	M, Yarn, Rubber Core.....	<b>45.00B pr.</b>
<b>VFM172</b>	H, Yarn, Rubber Core.....	<b>45.00B pr.</b>
<b>VFM180</b>	S, Yarn, Synth Core.....	<b>45.00B pr.</b>
<b>VFM181</b>	MS, Yarn, Synth Core.....	<b>45.00B pr.</b>
<b>VFM182</b>	M, Yarn, Synth Core.....	<b>45.00B pr.</b>
<b>VFM183</b>	H, Yarn, Synth Core.....	<b>45.00B pr.</b>
<b>VFM184</b>	H, Yarn, Marimba.....	<b>45.00B pr.</b>
<b>VFM185</b>	S, Yarn, Vibe.....	<b>57.75B pr.</b>
<b>VFM186</b>	M, Yarn, Vibe.....	<b>57.75B pr.</b>
<b>VFM187</b>	MH, Yarn, Vibe.....	<b>57.75B pr.</b>
<b>VFM189</b>	VH, Cord Vibe.....	<b>57.75B pr.</b>
<b>VFM188</b>	H, Yarn, Vibe.....	<b>57.75B pr.</b>
<b>VFM61</b>	H, 1 1/8" Lexan Ball.....	<b>44.65B pr.</b>
<b>VFM63</b>	H, 1 1/2" Ploy Ball.....	<b>55.65B pr.</b>
<b>VFM71</b>	Hard, Marimba, Black.....	<b>45.70B pr.</b>
<b>VFM75</b>	Medium, Vibes, Gray.....	<b>54.60B pr.</b>
<b>VFM76</b>	Hard, Vibes, Black.....	<b>54.60B pr.</b>

## ANDREW MARKWORTH

<b>VFM230</b>	Soft Marimba - Yarn.....	<b>\$52.50B pr.</b>
<b>VFM231</b>	Medium Marimba - Yarn.....	<b>52.50B pr.</b>
<b>VFM231H</b>	Medium-Hard Marimba - Yarn.....	<b>52.50B pr.</b>
<b>VFM232L</b>	Lighter Weight, Hard Marimba - Yarn.....	<b>63.50B pr.</b>
<b>VFM232</b>	Hard Marimba - Yarn.....	<b>52.50B pr.</b>
<b>VFM233</b>	Soft Vibe - Yarn.....	<b>66.15B pr.</b>
<b>VFM234</b>	Medium Vibe - Yarn.....	<b>66.15B pr.</b>
<b>VFM235</b>	Hard Vibe - Yarn.....	<b>66.15B pr.</b>

www.vicfirth.com

# SILVER FOX PERCUSSION



## MAPLE DRUM STICKS

WOOD-TIP	Length	Diameter	Neck	Taper	Bead	Weight
FOX2B	15 <sup>7</sup> / <sub>8</sub> "	5/8"	9/32"	Short	Olive	58 Gm
FOX5B	16 <sup>1</sup> / <sub>8</sub> "	19/32"	1/4"	Medium	Olive	54 Gm
FOX5A	16"	17/32"	1/4"	Long	Elipse	41 Gm
FOX7A	15 <sup>5</sup> / <sub>8</sub> "	1/2"	1/4"	Medium	Olive	39 Gm
FOXJXW	16 <sup>1</sup> / <sub>4</sub> "	17/32"	1/4"	Long	Teardrop	41 Gm

## MARCHING DRUMSTICKS

WOOD-TIP	Length	Diameter	Neck	Taper	Bead	Weight
FOX3S	17"	23/32"	11/32"	Medium	Acorn	77 Gm.
FOX4S	17"	45/64"	7/16"	Short	Olive	82 Gm.
FOXMB	16 <sup>3</sup> / <sub>8</sub> "	11/16"	13/32"	Medium	Olive	74 Gm.
FOXMS	16 <sup>3</sup> / <sub>8</sub> "	23/32"	15/32"	Medium	Olive	87 Gm.
FOXCSN	16"	11/16"	7/16"	Short	Ball	79 Gm.

FOX1001W James Campbell Model



## CHIME MALLETS

PM3	Two-Tone Chime Mallet – 1.5" Head	\$40.00B
PM4	Two-Tone Chime Mallet – 1.75" Head	40.00B

## TIMPANI MALLETS

FOXT301	Soft	\$42.00
FOXT303	Medium	42.00
FOXT305	Hard	42.00

## MARIMBA MALLETS

FOX730	Med, Purple	\$52.00B pr.
--------	-------------	--------------

**FAX & E-MAIL ORDERS FOR PRINTED  
MUSIC WILL GET AN EXTRA  
5% DISCOUNT**

**FAX:  
(708) 496-2130  
(888) 983-5537**

**E-MAIL:  
sales@harristeller.com**

## ALUMINUM SHAFT MALLETS, QUICK SILVER

	Multi Tom - TA	Bass Drum - BA
FOXTA1	Acetal ball, multi-tom mallets, length 14 <sup>1</sup> / <sub>2</sub> "	\$42.00 pr.
FOXTA2	Felt ball, multi-tom mallets, length 15"	44.00 pr.
FOXBA4	Hard felt head, 14" length	48.00 pr.
FOXBA1	Small ball, hard felt mallets, length 14" for 20"	50.00 pr.
FOXBA2	Medium ball, hard felt mallets, length 14 <sup>1</sup> / <sub>4</sub> "	52.00 pr.
FOXBA3	Large ball, hard felt mallets, length 15"	60.00 pr.
FOXBA4	Extra Large Ball	68.00 pr.

## MAPLE SHAFT MALLETS WITH CONTOURED GRIP

	Multi Tom - CT	Bass Drum - CB
FOXCT1	Acetal ball, multi-tom mallets, length 14 <sup>1</sup> / <sub>2</sub> "	\$42.00B pr.
FOXCB4	Hard felt head, 14" length	48.00 pr.
FOXCB2	Medium ball, hard felt mallets, length 14 <sup>1</sup> / <sub>4</sub> "	52.00 pr.
FOXCB3	Large ball, hard felt mallets, length 15"	60.00 pr.
FOXCB4	Extra Large Ball	68.00 pr.

## MAPLE SHAFT MALLETS WITH VINYL GRIPS

	Multi Tom - T	Bass Drum - B
FOXT1	Acetal ball, multi-tom mallets, length 14 <sup>1</sup> / <sub>2</sub> "	\$42.00B pr.
FOXBT1	Small ball, hard felt mallets, length 14" for 20"	50.00B pr.
FOXBT2	Medium ball, hard felt mallets, length 14 <sup>1</sup> / <sub>4</sub> "	52.00B pr.
FOXBT3	Large ball, hard felt mallets, length 15"	60.00B pr.

## GROVER PRO PERCUSSION



GM210	Xylophone Mallets, Rubber, Soft	\$28.00 pr.
GM212	Xylophone Mallets, Rubber, Med	28.00 pr.
GM214	Xylophone Mallets, Rubber, Hard	28.00 pr.
GM220	Bell Mallets, Soft, Cord	36.00 pr.
GM222	Bell Mallets, Med., Cord	36.00 pr.
GM224	Bell Mallets, Hard, Cord	36.00 pr.
GM240	Marimba Mallets, Soft, Yarn	36.00 pr.
GM242	Marimba Mallets, Med, Yarn	36.00 pr.
GM244	Marimba Mallets, Hard, Yarn	36.00 pr.
GMM202	Hard, Delrin Mallets	34.00 pr.
PM3	Two-Tone Chime Mallet – 1.5" Head	40.00B
PM4	Two-Tone Chime Mallet – 1.75" Head	40.00B
TRB4	4" Piccolo Triangle, Bronze	53.00B
TRB5	5" Concert Triangle, Bronze	55.00B
TRB6	6" Concert Triangle, Bronze	57.00B
TRB7	7" Symphony Triangle, Bronze	59.00B
TRB8	8" Symphony Triangle, Bronze	61.00B
TRB9	9" Symphony Triangle, Bronze	63.00B
S2TC	Triangle Clip	16.00B
S2TBSSET	3-Piece Beater Set	29.00B
TBS	6-Piece Beater Set	64.00*

\* = Call for Dealer Cost

www.silverfoxpercussion.com

# PRO MARK



## AMERICAN HICKORY WOOD TIP

TX2BW	.....	\$15.25 pr.
TX2SW	.....	15.25 pr.
TX3ALW	.....	15.25 pr.
TX5AW	.....	15.25 pr.
TX5ALW	Starr.....	17.25 pr.
TX5AXW	Adler.....	17.25 pr.
TX5BW	.....	15.25 pr.
TX7AW	.....	17.25 pr.
TX8AW	Rupp.....	17.25 pr.
TX9AW	Allen.....	17.25 pr.
TX11AW	Morello.....	17.25 pr.
TX101W	Dom Howard.....	17.25 pr.
TX515W	Jordison Blood.....	17.25 pr.
TX409W	DeGrasso.....	17.25 pr.
TX707W	Phillips.....	17.25 pr.
TX718W	Acid Jazz.....	15.25 pr.
TX718LW	Gully.....	17.25 pr.
TX721W	Minnemann.....	17.25 pr.
TX733W	Carvin.....	17.25 pr.
TX735W	Ferrone.....	17.25 pr.
TX737W	.....	15.25 pr.
TX747W	Rock.....	15.25 pr.
TX747BW	Super Rock.....	15.25 pr.
TX808W	Wertico.....	17.25 pr.
TX808LW	Pace.....	17.25 pr.
TXCPW	Palmer.....	17.25 pr.
TXRKW	Rock Knocker.....	15.25 pr.
TXSD9W	Campbell.....	17.25 pr.
TX510W	Thomas Pridgen.....	17.25 pr.
TX526W	Billy Ward "The Bulb".....	17.25 pr.
TX757W	Ray Luzier.....	17.25 pr.



## NYLON TIP

TX2BN	.....	\$15.75 pr.
TX2BXN	Lombardo.....	17.75 pr.
TX5AN	.....	15.75 pr.
TX5ABN	.....	15.75 pr.
TX5BN	.....	15.75 pr.
TX5BXN	Bittner.....	17.75 pr.
TX7AN	.....	15.75 pr.
TX11AN	Morello.....	17.75 pr.
TX420N	Portnoy.....	17.75 pr.
TX707N	.....	15.75 pr.
TX739N	.....	15.75 pr.
TX747N	Rock.....	15.75 pr.
TX747BN	Super Rock.....	15.75 pr.
TX808N	.....	15.75 pr.
TXJAZZN	.....	15.75 pr.



## PRO GRIP WOOD TIP

TXPG5AW	.....	\$19.75 pr.
TXPG5BW	.....	19.75 pr.
TXPG747W	.....	19.75 pr.

## HICKORY NATURAL

NAT2BW	.....	\$15.25 pr.
NAT5AW	.....	15.25 pr.
NAT5BW	.....	15.25 pr.
NAT747W	.....	15.25 pr.
NAT2BN	.....	15.75 pr.
NAT5AN	.....	15.75 pr.
NAT5BN	.....	15.75 pr.
NAT7AN	.....	15.75 pr.
NAT747N	.....	15.75 pr.



PROSD1W

## MAPLE WOOD TIP ONLY

PROSD1W	.....	\$15.25 pr.
PROSD2W	.....	15.25 pr.
SD531W	Bonham.....	17.25 pr.
SD4	Bruford.....	17.25 pr.
SD330W	Sucherman.....	17.25 pr.
MJZ3	Jazz.....	15.25 pr.
MJZ5	Jazz.....	15.25 pr.
MJZ7	Jazz.....	15.25 pr.
MJZ9	Jazz.....	15.25 pr.



FBH535TW

## SELECT BALANCE

Drummers essentially prefer two types of stick balance, forward or rebound. We have identified the key elements of a drumstick in order of priority as diameter; length; taper; tip shape; an tip material. **We have decided to start this series with all wood tip models.**

There are five key diameters that effectively cover the majority of the drumstick market: .535", .550", .565", .580", .595". Forward Balance – The forward balance sticks feature a 2 1/4" taper. This gives them more mass at the top of the stick generating more forward balance. Rebound Balance – The rebound balance sticks feature a 3" taper placing the weight in the back of the stick. This will generate more rebound from each stroke.

FBH535TW	Forward Balance .535".....	\$15.25
RBH535TW	Rebound Balance .535".....	15.25
FBH550TW	Forward Balance .550".....	15.25
RBH550TW	Rebound Balance .550".....	15.25
FBH565TW	Forward Balance .565".....	15.25
RBH565TW	Rebound Balance .565".....	15.25
FBH580TW	Forward Balance .580".....	15.25
RBH580TW	Rebound Balance .580".....	15.25
FBH595TW	Forward Balance .595".....	15.25
RBH595TW	Rebound Balance .595".....	15.25



2BN

## JAPANESE OAK NYLON TIP

2BN	.....	\$20.00 pr.
5AN	.....	20.00 pr.
5BN	.....	20.00 pr.
7AN	.....	20.00 pr.
707N	.....	20.00 pr.
727N	.....	20.00 pr.
747N	.....	20.00 pr.
747BN	.....	20.00 pr.
808N	.....	20.00 pr.
JAZZN	.....	20.00 pr.



## JAPANESE OAK WOOD TIP

2BW	.....	\$19.50 pr.
2SW	Aldridge.....	21.00 pr.
5AW	.....	19.50 pr.
5ASTW	.....	19.50 pr.
5BW	.....	19.50 pr.
7AW	.....	19.50 pr.
707W	Shaughnessy.....	21.00 pr.
719W	Stephen Perkins.....	21.00 pr.
727W	.....	19.50 pr.
747W	Pearl.....	21.00 pr.
747BW	Super Rock.....	19.50 pr.
777W	.....	19.50 pr.
808W	.....	19.50 pr.
JZW	.....	19.50 pr.
RKW	.....	19.50 pr.
SD22W	DeLucia "Con-Set".....	21.00 pr.
515W	Joey Jordison.....	21.00 pr.

# PRO MARK



## PERFORMER SERIES MARCHING BASS DRUM MALLET

<b>PSMB1</b>	Rudimental.....	<b>\$54.00 pr.</b>
<b>PSMB2</b>	Small Felt.....	<b>57.00 pr.</b>
<b>PSMB3</b>	Medium/Small Felt.....	<b>62.00 pr.</b>
<b>PSMB4</b>	Medium/Large Felt.....	<b>76.00 pr.</b>
<b>PSMB5</b>	Large Felt.....	<b>90.00 pr.</b>
<b>PSMB30I</b>	Rubber – Indoor.....	<b>50.00 pr.</b>
<b>PSMB32I</b>	Rubber – Indoor.....	<b>52.00 pr.</b>
<b>BS10</b>	Bass Stick – Indoor.....	<b>31.00 pr.</b>
<b>BS12</b>	Bass Stick – Indoor.....	<b>31.00 pr.</b>
<b>PSMB1S</b>	Rudimental Soft “Puffy”.....	<b>59.00 pr.</b>
<b>PSMB2S</b>	Small Soft “Puffy”.....	<b>55.50 pr.</b>
<b>PSMB3S</b>	Medium/Small Soft “Puffy”.....	<b>72.00 pr.</b>
<b>PSMB4S</b>	Medium/Large Soft “Puffy”.....	<b>86.00 pr.</b>
<b>PSMB5S</b>	Large Soft “Puffy”.....	<b>100.00 pr.</b>



## TENOR MALLET/STICKS

<b>ATA1</b>	Aluminum/Nylon Cookie.....	<b>\$50.00 pr.</b>
<b>ATA2</b>	Aluminum/Felt.....	<b>59.00 pr.</b>
<b>ATA2S</b>	Aluminum/Puffy.....	<b>65.00 pr.</b>
<b>ATA3</b>	Aluminum/Acrylic.....	<b>50.00 pr.</b>
<b>ATA4</b>	Aluminum/Rubber.....	<b>50.00 pr.</b>
<b>ATH1</b>	Hickory/Nylon Cookie.....	<b>50.00 pr.</b>
<b>ATH2</b>	Hickory/Felt.....	<b>54.50 pr.</b>
<b>ATH2S</b>	Hickory/Puffy.....	<b>59.00 pr.</b>
<b>ATA20I</b>	Aluminum/Nylon – Indoor.....	<b>50.00 pr.</b>
<b>TS1</b>	Hickory/Wood Tip.....	<b>21.00 pr.</b>
<b>PTS2</b>	Hickory/Nylon Cookie.....	<b>30.00 pr.</b>
<b>TS3</b>	Hickory/Nylon.....	<b>31.50 pr.</b>
<b>TS5</b>	Hickory/Wood Tip.....	<b>22.50 pr.</b>
<b>TS7</b>	Stevens Hickory/Nylon.....	<b>34.00 pr.</b>
<b>TS7S</b>	Stevens Mallets Nylon Head/Felt Butt.....	<b>55.00 pr.</b>
<b>NP318R</b>	Nick Petrella “Multi Percussion”.....	<b>65.00 pr.</b>
<b>TS8</b>	Sean Vega/Nylon Hickory System Blue.....	<b>32.00 pr.</b>



## DIVERSITY SERIES

<b>DV1</b>	System Blue – Soft.....	<b>\$45.00B pr.</b>
<b>DV2</b>	System Blue – Medium.....	<b>45.00B pr.</b>
<b>DV3</b>	System Blue – Medium Hard.....	<b>45.00B pr.</b>
<b>DV4</b>	System Blue – Hard.....	<b>45.00B pr.</b>
<b>DV5R</b>	System Blue – Soft Vibe.....	<b>72.00B pr.</b>
<b>DV6R</b>	System Blue – Medium Vibe.....	<b>72.00B pr.</b>
<b>DV7R</b>	System Blue – Medium Hard Vibe.....	<b>72.00B pr.</b>
<b>DV8R</b>	System Blue – Hard Vibe.....	<b>72.00B pr.</b>

## PERFORMER SERIES

<b>PST1</b>	Timp Mallet Maple – Soft.....	<b>\$50.00 pr.</b>
<b>PST2</b>	Timp Mallet Maple – Medium Soft.....	<b>50.00 pr.</b>
<b>PST3</b>	Timp Mallet Maple – Medium/General.....	<b>50.00 pr.</b>
<b>PST4</b>	Timp Mallet Maple – Hard/Staccato.....	<b>50.00 pr.</b>
<b>PST5</b>	Timp Mallet Maple – Ultra Staccato.....	<b>50.00 pr.</b>



## PERFORMER SERIES MARIMBA/VIBES

<b>PSM10</b>	Soft.....	<b>\$47.50B pr.</b>
<b>PSM20</b>	Medium Soft.....	<b>47.50B pr.</b>
<b>PSM25</b>	Medium.....	<b>47.50B pr.</b>
<b>PSM30</b>	Medium Hard.....	<b>47.50B pr.</b>

## ENSEMBLE SERIES

<b>ES1R</b>	Rattan – Soft.....	<b>\$50.00B pr.</b>
<b>ES2R</b>	Rattan – Medium Soft.....	<b>50.00B pr.</b>
<b>ES3R</b>	Rattan – Medium.....	<b>50.00B pr.</b>
<b>ES4R</b>	Rattan – Medium Hard.....	<b>50.00B pr.</b>
<b>ES5R</b>	Rattan – Hard.....	<b>50.00B pr.</b>

## OPTIMA SERIES MARCHING BASS DRUM MALLET

<b>OBD1</b>	Optima Bass – 1, Hickory Handle/Felt.....	<b>59.00 pr.</b>
<b>OBD2</b>	Optima Bass – 2, Hickory Handle/Felt.....	<b>63.00 pr.</b>
<b>OBD3</b>	Optima Bass – 3, Hickory Handle/Felt.....	<b>67.00 pr.</b>
<b>OBD4</b>	Optima Bass – 4, Hickory Handle/Felt.....	<b>77.00 pr.</b>
<b>OBD5</b>	Optima Bass – 5, Hickory Handle/Felt.....	<b>85.00 pr.</b>

## JIM WUNDERLICH

<b>JW1</b>	System Blue – Soft.....	<b>\$55.00B pr.</b>
<b>JW2</b>	System Blue – Medium Soft.....	<b>55.00B pr.</b>
<b>JW3</b>	System Blue – Medium.....	<b>55.00B pr.</b>
<b>JW4</b>	System Blue – Medium Hard.....	<b>55.00B pr.</b>
<b>JW5</b>	System Blue – Hard.....	<b>55.00B pr.</b>
<b>JW6R</b>	System Blue – Soft Vibe.....	<b>65.00B pr.</b>
<b>JW7R</b>	System Blue – Medium Vibe.....	<b>65.00B pr.</b>
<b>JW8R</b>	System Blue – Medium Hard Vibe.....	<b>65.00B pr.</b>
<b>JW9R</b>	System Blue – Hard Vibe.....	<b>65.00B pr.</b>

## JEFF MOORE KEYBOARD MALLET

<b>JM12</b>	Birch Medium Soft.....	<b>\$55.00B pr.</b>
<b>JM13</b>	Birch Medium Hard.....	<b>55.00B pr.</b>
<b>JM14</b>	Birch Hard.....	<b>55.00B pr.</b>
<b>JM15R</b>	Rattan Soft.....	<b>70.00B pr.</b>



## XYLOPHONE/BELLS

### Rattan Handles

<b>PSX10R</b>	Rattan Soft.....	<b>\$48.00B pr.</b>
<b>PSX20R</b>	Rattan Medium Hard.....	<b>48.00B pr.</b>
<b>PSX30R</b>	Rattan Hard.....	<b>48.00B pr.</b>
<b>PSX50R</b>	Rattan – Teflon.....	<b>52.50B pr.</b>

## BAMBOO-HANDLE TIMPANI MALLET

<b>PSTB10</b>	Ultra Hard Felt Head.....	<b>\$79.00B pr.</b>
<b>PSTB20</b>	Hard Felt Head.....	<b>116.00B pr.</b>
<b>PSTB30</b>	Medium Hard Felt Head.....	<b>118.00B pr.</b>
<b>PSTB40</b>	Soft Felt Head.....	<b>120.00B pr.</b>
<b>PSTB50</b>	Hard Wood Head.....	<b>59.00B pr.</b>

## FUTURE PRO SERIES

<b>TXSD1FW</b>	Future Pro Snare.....	<b>\$14.50 pr.</b>
<b>TXRW</b>	Junior.....	<b>14.50 pr.</b>

# PRO MARK



## PERFORMER SERIES AUTOGRAPH

EG3	Medium Evelyn Glennie.....	\$55.00B pr.
EG5	Hard Evelyn Glennie.....	55.00B pr.
PLH	Rattan Lionel Hampton.....	65.00B pr.
PBM	Rattan Bill Molenhof Vibes.....	65.00B pr.
PBM40	Rattan "Rotational" Vibes.....	65.00B pr.



## JONATHAN HAAS TIMPANI

PJH1	Ultra Staccato.....	\$64.00 pr.
PJH2	Staccato.....	66.00 pr.
PJH3	Hard.....	68.00 pr.
PJH4	General Purpose.....	70.00 pr.
PJH5	Oversized General.....	63.95 pr.
PJH6	Roller.....	85.00 pr.

## JH Mallet Re-Covering Kits

JH1R	Red.....	\$9.00B pr.
JH2R	Green.....	9.00B pr.
JH3R	White.....	9.00B pr.
JH4R	White.....	9.00B pr.
JH5R	White.....	9.00B pr.

## ORCHESTRAL BASS DRUM

PSBD3	General.....	\$95.00 ea.
-------	--------------	-------------



## EDUCATIONAL KEYBOARD

DFP210	Soft Tan Rubber on Birch.....	\$30.00B pr.
DFP230	Med. Green Rubber on Birch.....	30.00B pr.
DFP250	Hard Gray Rubber on Birch.....	30.00B pr.
DFP600	1" Phenolic on Rattan.....	45.00B pr.
DFP610	1 1/8" Phenolic on Rattan.....	45.00B pr.
DFP620	Brass Bell or Crotales on Rattan.....	45.00B pr.
DFP640	1 1/8" Poly Xylo on Rattan.....	42.50B pr.



DFP710	Extra Soft Yarn on Birch.....	\$46.00B pr.
DFP720	Soft Yarn on Birch.....	46.00B pr.
DFP730	Medium Yarn on Birch.....	46.00B pr.
DFP740	Medium Hard Yarn on Birch.....	46.00B pr.
DFP750	Hard Yarn on Birch.....	46.00B pr.
DFP930	Medium Hard Cord on Rattan.....	55.00B pr.
DFP940	Hard Cord on Rattan.....	55.00B pr.

## EDUCATIONAL PACK

Includes one pair of drumsticks (TWSD1W), one pair of medium yarn mallets (DFP730), one pair of xylo-bell mallets (DFP640), one pair of general purpose timpani mallets (ATP1) and one drumstick/mallet bag (DSB4).

SPP1	Scholastic Pro.....	\$145.00
------	---------------------	----------



## DISCOVERY (ORFF) SERIES

FPY10	Soft Yarn.....	\$24.50B pr.
FPY20	Medium Yarn.....	24.50B pr.
FPY30	Hard Yarn.....	24.50B pr.
FPC10	Soft Cord.....	24.50B pr.
FPC20	Medium Cord.....	24.50B pr.
FPR10	Soft Rubber.....	21.50B pr.
FPR20	Medium Rubber.....	21.50B pr.
FPR30	3/4 Hard Rubber.....	21.50B pr.
FPP10	Very Hard Phenolic.....	25.00B pr.
FPA30	Hard Rubber.....	25.00B pr.
FPY100	Soft (Contra Bass).....	34.00B pr.

## PERFORMER SERIES AUTOGRAPH MALLETS

PJM	John Metzger.....	\$65.00B
-----	-------------------	----------



## PERFORMER GONG BEATERS & CHIME HAMMER

PSGB1	Large Gong Beater.....	\$79.00
PSGB2	Small Gong Beater.....	59.95

## BASS DRUM

PSMB1S	Rudimental Puffy.....	\$59.00
PSMB2S	Small Puffy.....	55.50
PSMB3S	Medium/Small Puffy.....	72.00
PSMB4S	Medium/Large Puffy.....	86.00
PSMB5S	Large Puffy.....	100.00

## TENOR MALLETS/STICKS

ATH2S	Puffy, Hickory Shaft.....	\$59.00
TS7S	Stevens Hick/Nylon/Felt.....	55.00



## KAI STENSGAARD MARIMBA MALLETS

KS2	Medium Soft.....	\$50.00B pr.
KS3	Medium.....	50.00B pr.
KS4	Medium Hard.....	50.00B pr.
KS5	Hard.....	50.00B pr.

## SPECIALTY STICKS

TUBZ	Red.....	\$17.00 pr.
GIANT	Giant Size Sticks.....	62.00 pr.



## ORCHESTRAL/CONCERT SNARE AMERICAN HICKORY

TXSD5	Multi Percussion Stick.....	\$39.00B pr.
TX739W	Evelyn Glennie.....	17.25 pr.

## MARCHING STICKS HICKORY WOOD TIP

TXDC1W	Jeff Moore.....	\$17.25 pr.
TXDC2W	Matt Savage.....	17.25 pr.
TXDC3S	.....	16.25 pr.
TXDC8W	Jeff Ausdemore.....	17.25 pr.
TXDC9	.....	16.25 pr.
TXDC10W	.....	16.25 pr.
TXXB3	Scott Johnson System Blue.....	34.00 pr.
TXDC17W	Scott Johnson.....	17.25 pr.
TXDC18iW	Jeff Ausdemore.....	17.25 pr.
TXDC20W	Indoor Dennis DeLucia.....	17.25 pr.
TXDC50W	System Blue.....	17.25 pr.
TXDC51W	System Blue.....	17.25 pr.
TXDC52W	System Blue.....	17.25 pr.



## TRADITIONAL MARCHING

M320S	Small Felt Bass Drum.....	\$69.00 pr.
M321M	Medium Felt Bass Drum.....	75.00 pr.
M322L	Large Felt Bass Drum.....	97.00 pr.



# MALLETECH



## Marimba

Density	Part #	Density	Part #	List	
<b>Leigh Howard Stevens</b>					
Super Soft White Yarn on Birch Handle					
S	MH	S	MTLS5	.....\$60.00B	
S	MH	MS H	MTLS15	.....60.00B	
MS	H	S	MH	MTLS17Z	.....60.00B
M	VH	H	XH	MTLS25	.....60.00B
VS	XH			MTLS27Z	

## Gordon Stout

Gray Synthetic Yarn on Birch Handle				
		MH	MTGS13	.....\$60.00B

## Michael Burritt

Black Wool Blend Yarn on Birch Handle					
VS		S	M	MTMB8	.....\$60.00B
M	MH	MH	H	MTMB18	.....60.00B
		S	H	MTMB21Z	.....60.00B

## Eric Sammut

Orange Yarn on Birch Handle					
		M	MH	MTES16	.....60.00B

## Concerto

No Fray Synthetic Yarn on Birch Handle					
S		S	M	MTCN9	.....\$52.00B
M	MH	VH		MTCN21	.....52.00B
XH		S	XH	MTCN28Z	.....52.00B

## Soloist

Super Charcoal Gray Yarn on Birch Handle					
		M		MTSO9	.....\$52.00B
		H		MTSO24	.....52.00B

## Stadium Series

100% Nylon on Birch Handle					
MH	H			MTSM14M	Marimba Red .....\$44.00B
VH				MTSM26M	Marimba Red .....44.00B
100% Red Nylon on Rattan Handle					
VH				MTSM27V	Vibraphone Red.....\$55.00B

## Vibe

100% Nylon on Rattan Handle					
S				MTJC12	Vibe/Marimba Red.....\$65.00B
H				MTJC16	Vibe/Marimba Red .....65.00B

## Dave Samuels

100% Nylon on Rattan Handle					
S	HW			MTDS10H	Vibe/Marimba Green.....\$65.00B
S				MTDS11	Vibe/Marimba Blue.....65.00B
H				MTDS18	Vibe/Marimba Blue.....65.00B
H	HW			MTDS19H	Heavy Vibe/Marimba Green....65.00B

## Xylo/Bell

Density	Part #	Description	List
<b>Bob Becker</b>			
Rattan Handle			
S	H	MTBB32	Xylophone .....\$46.00B
MH		MTBB34	Xylophone .....46.00B

## Enhanced Fundamental

1-1/4" Dia. Ball on Ratan Handle			
MH		MTEF35R	Xylophone .....\$42.00B
MH		MTEF41R	Xylophone .....42.00B
VH		MTEF47R	Bell.....42.00B
XH		MTEF50R	Bell.....42.00B

## 1-1/4" Dia. on Birch Handle

MH		MTEF35B	Xylophone .....\$35.00B
H		MTEF41B	Xylophone .....35.00B
VH		MTEF47B	Bell.....35.00B
XH		MTEF50B	Bell.....35.00B

## Orchestra

1-1/8" Dia. Ball on Rattan Handle			
H	LW	MTOR39R	Xylophone .....\$42.00B
H	MW	MTOR42R	Xylophone .....42.00B
H	HW	MTOR45R	Bells .....42.00B
XH	HW	MTOR48R	Bells .....42.00B

## On Orchestral Length Birch Handle

H	LW	MTOR39B	Xylophone .....\$35.00B
H	MW	MTOR42B	Xylophone .....35.00B
H	HW	MTOR45B	Bells .....35.00B
XH	HW	MTOR48B	Bells .....35.00B

## Marimba

Med	ESMM	.....44.00B
Hard	ESHM	.....44.00B

## Xylo

Soft	ESSX	.....\$38.00B
Med	ESMX	.....38.00B
Hard	ESHX	.....38.00B

## Vibe

Soft	ESSV	.....\$55.00B
Med	ESMV	.....55.00B
Hard	ESHV	.....55.00B

## Bell

Small	ESSB	.....\$38.00B
Large	ESLB	.....38.00B
Brass	ESBB	.....38.00B

## Timpani

Soft	ESST	.....\$56.00B
Med	ESMT	.....56.00B
Hard	ESHT	.....56.00B

Density	Part #	Density	Part #	List
<b>Natural Rubber</b>				

1-1/8" Dia. Ball on Rattan Handle					
S		MH		MTNR13R	.....\$42.00B
H				MTNR19R	
XH		VH		MTNR29R	.....42.00B

On Marimba Length Birch Handle					
S		MH		MTNR13B	.....\$35.00B
M		VH		MTNR29B	.....35.00B
XH				MTNR36B	

## Timpani

Density	Part #	Description	List
Hinger Touch-Tone® Aluminum Handles			
S		Yellow Label	.....\$78.00B
M		Green Label	.....78.00B
H		Red Label	.....78.00B
XH		Blue Label	.....78.00B

## Birch Wood Handle

S		Yellow Label	.....\$68.00B
M		Green Label	.....68.00B
H		Red Label	.....68.00B
XH		Blue Label	.....68.00B
N/A		PC3 Handle/Wt. Kit	.....68.00B

## Essential Series™

### Suspended Cymbal

Small	ESSC	.....\$44.00B
Med	ESMC	.....44.00B

### Bass Drum

Small	ESSBD	.....\$50.00 ea.B
Med	ESMBD	.....80.00 ea.B

### Cymbal, Natural

	SDMCMN	.....\$32.95
--	--------	--------------

### Cymbal, Black

	SDMCMB	.....\$32.95
--	--------	--------------

### Gong

	0550	.....\$49.00 ea.
--	------	------------------

### Wind Gong

	SDMWGM	.....\$35.00
--	--------	--------------

# ZILDJIAN

## DRUM STICKS

Crafted to the same extraordinarily high standards as Zildjian cymbals, Zildjian drumsticks and mallets simply feel great. Manufactured with state-of-the-art consistency, our drumsticks are guaranteed straight. Whatever your playing style, you'll find the perfect stick among Zildjian's vast selection of sizes, lengths, and tip styles. All of our sticks are crafted from the highest quality U.S. Hickory, Maple, or Birch woods.

**ARTIST SERIES:** Derived from each artist's individual style and custom crafted from the finest hardwoods.

**HICKORY SERIES:** This popular drumstick wood offers excellent response. Holds up in all types of playing situations, and produces a solid sound on drums and cymbals.

**MAPLE SERIES:** This light wood allows for larger diameter sticks without the weight.

**LAMINATED BIRCH:** Provides heavier weight, consistency, feel, and durability

**ANTI-VIBE™ SERIES:** Patented technology effectively reduces unwanted vibrations.

**DIP® SERIES:** Proprietary grip technology provides a soft grip and unique stick sounds.

**BRUSHES AND MALLETS:** Fixed and retractable wire brushes and mallets.

**SPECIALTY STICKS:** Multi-application specialty sticks.

### Hickory Series

FINISH WOOD NYLON  
TIP TIP

**7A**  
15<sup>1</sup>/<sub>2</sub>" /0.52

NATURAL 7AWN\* 7ANN\*

BLACK DIP® 7AWD\* 7AND\*

PURPLE DIP® 7AWP\* 7ANP

BLACK 7AWB\* 7ANB\*

ANTI-VIBE™ 7AWA\* 7ANA

**Super 7A**  
16" /0.525

NATURAL S7AWN\* S7ANN\*

**Timbale**  
16" /0.440

NATURAL TBWN N/A

**6A**  
16" /0.530

NATURAL 6AWN\* 6ANN

**Jazz**  
16" /0.540

NATURAL JZWN\* JZNN

**5A**  
16" /0.560

NATURAL 5AWN 5ANN\*

BLACK DIP® 5AWD 5AND\*

PURPLE DIP® 5AWP 5ANP

BLUE 5AWBU\* 5ANBU

BLACK 5AWB\* 5ANB\*

RED N/A 5ANR

ANTI-VIBE™ 5AWA\* 5ANA\*

**5A Acorn**  
16<sup>1</sup>/<sub>4</sub>" /0.570

NATURAL 5ACW N/A

BLACK DIP® 5ACD N/A

Black 5ACB N/A

**5A Acorn Neon**  
16<sup>1</sup>/<sub>4</sub>" /0.570

GREEN 5ACWDGG N/A

PINK 5ACWDGP N/A

YELLOW 5ACWDGY N/A

**Absolute Rock**  
16" /0.575

NATURAL ARWN N/A

**3A**  
16" /0.580

NATURAL 3AWN 3ANN

### Hickory Series

FINISH WOOD NYLON  
TIP TIP

**Trigger**  
16" /0.590

ANTI-VIBE™ TGWN\* N/A

**5B**  
16" /0.600

NATURAL 5BWN\* 5BNN\*

BLACK DIP® 5BWD\* 5BND\*

PURPLE DIP® 5BWP 5BNP

BLUE 5BWBU 5BNBU

BLACK 5BWB\* 5BNB\*

RED N/A 5BNR\*

ANTI-VIBE™ 5BWA\* 5BNA

**Z4A**  
16<sup>1</sup>/<sub>4</sub>" /0.550

NATURAL Z4AWN\* Z4ANN\*

**2B**  
16" /0.625

NATURAL 2BWN 2BNN

BLACK DIP® 2BWD 2BND

**Super 5A**  
16<sup>1</sup>/<sub>2</sub>" /0.585

NATURAL S5AWN\* S5ANN\*

PURPLE DIP® S5AWP S5ANP

ANTI-VIBE™ S5AWA S5ANA

**Super 5B**  
16<sup>1</sup>/<sub>2</sub>" /0.595

NATURAL S5BWN\* S5BNN\*

**Session Master**  
16<sup>1</sup>/<sub>2</sub>" /0.640

NATURAL SMWN SMNN

**Field Series 3000**  
16<sup>1</sup>/<sub>2</sub>" /0.700

NATURAL F3WN N/A

**Rock**  
16<sup>5</sup>/<sub>8</sub>" /0.625

NATURAL RKWN RKNN

BLACK DIP® RKWD RKND

### Maple Series

FINISH WOOD NYLON  
TIP TIP

**Super 7A**  
16" /0.525

MAPLE S7AM N/A

GREEN DIP® S7AMG\* N/A

**Jazz**  
16" /0.540

MAPLE JZM N/A

**5A**  
16" /0.550

MAPLE 5AM N/A

GREEN DIP® 5AMG\* N/A

**5B**  
16" /0.600

MAPLE 5BM N/A

GREEN DIP® 5BMG N/A

**Maple Acorn Tip**  
16" /0.620

MAPLE MPLA N/A

GREEN DIP® MPLAG N/A

**Mini Maple Ball**  
15<sup>3</sup>/<sub>4</sub>" /0.635

MAPLE MPLM N/A

GREEN DIP® MPLMG N/A

**General Orchestral**  
16<sup>1</sup>/<sub>2</sub>" /0.640

MAPLE GOWN N/A

### Laminated Birch Series

FINISH WOOD NYLON  
TIP TIP

**Super 7A**  
16" /0.525

LAM. BIRCH HS7AWN\* N/A

**6A**  
16" /0.530

LAM. BIRCH H6AWN N/A

**Heavy Jazz**  
16" /0.540

LAM. BIRCH HJWN\* N/A

**5A**  
16" /0.560

LAM. BIRCH H5AWN\* N/A

**5B**  
16" /0.600

LAM. BIRCH H5BWN N/A

# ZILDJIAN

## Artist Series

FINISH TIP PART#

Travis Barker  
16<sup>3/8"</sup> /0.595

WHITE WOOD ASTB\*

BLACK WOOD ASTBLK\*

Louie Bellson  
16<sup>1/4"</sup> /0.575

NATURAL WOOD ASLB

John Blackwell  
16<sup>3/8"</sup> /0.570

NATURAL WOOD ASBL

Hal Blaine  
15<sup>3/4"</sup> /0.500

NATURAL WOOD ASHB

Ronald Bruner Jr  
16" /0.550

ORANGE WOOD ASRB\*

Terri Lyne Carrington  
16" /0.530

NATURAL WOOD ASTC

Gary Chaffee  
16<sup>3/8"</sup> /0.575

NATURAL WOOD ASGC

Dennis Chambers  
16" /0.550

NATURAL WOOD ASDC\*

NATURAL NYLON ASDCN

Tré Cool  
16<sup>1/2"</sup> /0.625

NATURAL WOOD ASTR\*

Dave Grohl  
16<sup>3/4"</sup> /0.600

NATURAL WOOD ASDG\*

Trilok Gurtu  
16" /0.550

WALNUT/DIP® WOOD ASTG\*

Trilok Gurtu ROCK  
16<sup>3/8"</sup> /0.610

WALNUT/DIP® WOOD ASTGR

## Artist Series

FINISH TIP PART#

Taylor Hawkins  
15<sup>7/8"</sup> /0.600

NATURAL WOOD ASTH

Roy Haynes  
15<sup>7/8"</sup> /0.550

WALNUT WOOD ASRH

Manu Katché  
15<sup>15/16"</sup> /0.550

NATURAL WOOD ASMK

Joey Kramer  
16<sup>1/4"</sup> /0.550

DIP® WOOD ASJGK

Mike Mangini  
16<sup>1/2"</sup> /0.585

LAM. BIRCH WOOD ASMM\*

Dave McClain  
16<sup>5/8"</sup> /0.600

RAW™ WOOD ASDM

John Otto  
16" /0.560

CHARCOAL WOOD ASOT

John Riley  
16" /0.550

NATURAL WOOD ASJO\*

Antonio Sanchez  
16<sup>1/4"</sup> /0.550

NATURAL WOOD ASAS

Danny Seraphine  
16" /0.560

NATURAL WOOD ASDS

Eric Singer  
16" /0.620

NATURAL WOOD ASES

Matt Sorum  
16<sup>5/8"</sup> /0.600

NATURAL WOOD ASMS

Zak Starkey  
16" /0.555

NATURAL WOOD ASZS

## Artist Series

FINISH TIP PART#

Ringo Starr  
16" /0.545

NATURAL/DIP® WOOD ASRS

Bill Stewart  
15<sup>7/8"</sup> /0.500

NATURAL WOOD ASBS

Kozo Suganuma  
16<sup>1/4"</sup> /0.550

NATURAL NYLON ASKS

Ronnie Vannucci  
16<sup>1/2"</sup> /0.610

MAPLE WOOD ASRV

Brooks Wackerman  
16<sup>1/8"</sup> /0.605

NATURAL NYLON ASBW

Tony Williams  
16" /0.625

NATURAL WOOD ASTW

Adrian Young  
16<sup>1/2"</sup> /0.585

B/W NYLON ASAY\*

## Timbale Sticks

FINISH TIP PART#

Luis Conte  
15<sup>1/2"</sup> /0.455

NATURAL WOOD ASLC\*

Giovanni Hidalgo  
14<sup>7/8"</sup> /0.440

GOLDEN WOOD ASGH

Marc Quiñones Rock  
16<sup>5/8"</sup> /0.500

NATURAL/DIP® WOOD ASMQR\*

Marc Quiñones Salsa  
16<sup>5/8"</sup> /0.465

NATURAL/DIP® WOOD ASMQ\*

# DRUMSTICKS

## Brushes & Specialty Sticks

PART# PRICE

Fixed Wire Brushes,  
Non-Retractable

SDWBF \$34 pr

Professional Wire  
Brushes, Retractable

SDWBZB1 \$34 pr\*

Bent Bristle Brush

SDWB3 \$39.95 pr

Dennis Chambers  
Double-Stick Mallet

sdmDC \$32.50 pr\*

Travis Barker  
Double-Stick Mallet

sdmTB \$32.50 pr\*

John Riley  
Double-Stick Mallet

sdmJO \$32.50 pr\*

Mezzo 1 - Multi-Rod  
(Low Volume Option)

sdm1 \$28.50 pr\*

Mezzo 2 - Multi-Rod  
(Moderate Volume  
Option)

sdm2 \$28.50 pr\*

## MALLETS

Suspended Cymbal,  
Natural

sdmSC \$49.95

Cymbal, Natural

sdmCMN \$32.95 pr

Cymbal, Black

sdmCMB \$32.95 pr\*

Gong

P0550 \$49\*

Wind Gong

sdmWGM \$49

## Drumstick Pricing Information

Manufacturer's  
suggested retail prices

**Hickory, Maple &  
Laminated Birch**

PER PAIR / PER 6 PACK

Wood Tip \$15.50 **\$93.00**

Nylon Tip \$16.00 **\$96.00**

Neon \$16.75 **\$100.50**

Timbale \$11.00 **\$66.00**

Anti-Vibe \$21.75 **\$130.50**

Laminated

Birch \$21.75 **\$130.50**

## Artist

All Models \$17.25 \$103.50

Gurtu \$17.75 \$106.50

Gurtu Rock \$17.75 \$106.50

Starr \$17.75 \$106.50

Young \$17.75 \$106.50

Hidalgo \$12.00 \$72.00

Conte \$12.00 \$72.00

Mangini \$21.75 \$130.50

Kramer \$17.75 \$106.50

## DIP®

All Models \$17.25 \$103.50

### TIP



ACORN



LONG OVAL



POINTED



SATURN RING



BARREL



OVAL



ROUND



TEARDROP



BUTT



OVERSIZED BARREL

Best Sellers = \*

New/Re-released Models = orange box

# INNOVATIVE PERCUSSION



## FUNDAMENTAL SERIES

F1	Soft Marimba.....	\$30.00
F1.5	Medium Marimba.....	30.00
F2	Hard Marimba.....	30.00
F3	Soft Vibraphone/Birch.....	30.00
F3.5	Medium Vibraphone/Birch.....	30.00
F4	Hard Vibraphone/Birch.....	30.00
F5	Soft Vibraphone/Rattan.....	50.00
F5.5	Medium Vibraphone/Rattan.....	50.00
F6	Hard Vibraphone/Rattan.....	50.00
F7	Soft Rubber Marimba.....	22.00
F8	Medium Rubber Marimba.....	22.00
F8.5	Hard Rubber Marimba.....	22.00
F9	Xylophone.....	22.00
F10	Hard Xylophone.....	22.00
F11	Hard Bell/Brass.....	22.00
F12	Medium Bell/Xylophone.....	22.00

## ARENA SERIES MULTI-TOM MALLETS/DRUMSTICKS

IPAT1	Multi-Tom Mallet/Synthetic.....	\$46.00
IPAT1A	Aluminum Shaft Multi-Tom Mallet/Synthetic.....	49.00
IPAT2	Multi-Tom Stick/Synthetic (Small Disc).....	43.00

## FUNDAMENTAL PACKAGES

FP1	Elementary Pack – F8, F10, IP-LD & SB-3.....	\$91.00
FP2	Intermediate Pack – F2, F9, CT-3, IP-LD & SB-3.....	148.00
FP3	College Primer Pack – RS251(2), IP240(2), IP902, IP906, CT-3, IP-JC & MB-1.....	338.00B

## CONCERT SNARE DRUMSTICKS

IPCL1	Christopher Lamb Model #1/Maple.....	\$18.25
IPCL1L	Christopher Lamb Model #1/Laminate.....	38.25
IPCL2L	Christopher Lamb Model #2/Laminate.....	38.25
IPCL3L	Christopher Lamb Model #3/Laminate.....	38.25
IP1	General/Hickory.....	16.25
IPJC	James Campbell Model/Hickory.....	18.25
IPJC2	James Campbell Laminated Birch.....	38.25
IPLD	Lalo Davila Model/Hickory.....	18.25
IPKW	Kennan Wylie Model/Maple.....	18.25

## MULTI-PERCUSSION DRUMSTICKS & MALLETS

IP1M	Multi-Percussion/Hickory & Hard Felt.....	\$36.50
IPJC1M	James Campbell Multi-Stick/Chamois – Soft.....	57.00
IPJC2M	James Campbell Multi-Stick/Chamois – Hard.....	54.00
IPJC1SC	James Campbell Suspended Cymbal – Soft.....	58.00
IPJC2SC	James Campbell Suspended Cymbal – Hard.....	58.00
IP5AT	IP-5A / Timpani Combo.....	53.00
IP5AX	IP-5A / Xylo / Bell Combo.....	49.00
IPGTX	Timpani / Xylo / Bell Combo.....	73.00

## CONCERT BASS DRUM, GONG & CHIME MALLETS

IPCB1	Concert Bass Drum/Extra Large.....	\$60.00
IPCB2	Concert Bass Drum/Soft.....	56.00
IPCB3	Concert Bass Drum/Medium.....	54.00
IPCB4	Concert Bass Drum/Hard.....	50.00
IPCB5	Concert Bass Drum/Rollers (PR).....	71.00
IPCB6	Concert Bass Drum/Extra Hard – Chamois.....	71.00
CG1	Gong Mallet/Large.....	68.00
CG1S	Gong Mallet/Large Soft.....	72.00
CG2	Gong Mallet/Small.....	56.00
CG2S	Gong Mallet/Small Soft.....	57.00
IPCC1	Concert Chime Hammer – Large.....	46.00
IPCC2	Concert Chime Hammer – Medium.....	46.00
IPCLC1	Christopher Lamb Chime Hammer Large.....	52.00
IPCLC2	Christopher Lamb Chime Hammer Medium.....	52.00

## CONCERT TIMPANI MALLETS

IPCT1	Timpani/Soft.....	\$61.00
IPCT2	Timpani/Medium Soft, General.....	61.00
IPCT3	Timpani/Medium, General.....	61.00
IPCT4	Timpani/Medium Hard, General.....	61.00
IPCT5	Timpani/Hard, Staccato.....	61.00
IPCT6	Timpani/Hard Felt, Ultra Staccato.....	48.50

## GENERAL TIMPANI MALLETS

GT1	General Timpani/Soft.....	\$50.00
GT2	General Timpani/Medium Soft, General.....	50.00
GT3	General Timpani/Medium, General.....	50.00
GT4	General Timpani/Hard, Staccato.....	50.00
GT5	General Timpani/Ultra Staccato.....	46.00

## ARENA SERIES MARCHING DRUMSTICKS

IPASBK	Bret Kuhn Model/Hickory.....	\$18.25
ASMM	Mike McIntosh Model/Hickory.....	18.25

## LEGACY SERIES

The Legacy Series features a traditional teardrop bead. The L7A, L5A, L5AL, L5B, L5BL and L1A are all constructed with the bead. Also within the series are the L3A and L8A, which are built with a barrel tip.

IPL5AB	Legacy Series Drumset Model 5AB / Hickory.....	\$15.25
IPL2B	Legacy Series Drumset Model 2B / Hickory.....	15.25
IPLM7A	Legacy Series Drumset Model 7A / Maple.....	15.25
IPLM5A	Legacy Series Drumset Model 5A / Maple.....	15.25
IPLM5B	Legacy Series Drumset Model 5B / Maple.....	15.25
IPL7A	Hickory/Teardrop Bead.....	15.25
IPL5A	Hickory/Teardrop Bead.....	15.25
IPL5AL	Hickory/Teardrop Bead.....	15.25
IPL3A	Hickory/Barrel Bead.....	15.25
IPL5B	Hickory, Teardrop Bead.....	15.25
IPL5BL	Hickory/Teardrop Bead.....	15.25
IPL1A	Hickory/Teardrop Bead.....	15.25
IPL8A	Hickory, Small Barrel Bead.....	15.25

## DRUMSET MODELS – HICKORY

IPJW1	Joey Waronker Model – Quick Taper/Elongated Bead.....	\$16.50
IPCM1	Chris McHugh Model / Hickory.....	16.50
IPJW2	Joey Waronker Studio Model / Hickory.....	16.50

## PIPE BAND MALLETS

IPPT1	Pipe Band Tenor Mallets.....	\$52.00
-------	------------------------------	---------

## FIELD SERIES MARCHING DRUMSTICKS

IPFS1	Marching Stick/Hickory.....	\$16.75
FS1N	Marching Stick/Nylon Tip.....	18.75
FS2	Marching Stick/Hickory.....	16.75
FSIJ	Ike Jackson Model/Hickory.....	17.50
FSBK	Bret Kuhn Model/Hickory.....	18.25
FSJC	Jim Casella Model/Hickory.....	18.25
FSMM	Mike McIntosh Model/Hickory.....	18.25
FSPR	Paul Rennick Model #1/Hickory.....	18.25
FSPR2	Paul Rennick Model #2/Hickory.....	18.25
FSTF	Tim Fairbanks Model/Hickory.....	18.25
FSSG	Shane Gwaltney Model/Hickory.....	18.25

## FIELD SERIES MULTI-TOM MALLETS/DRUMSTICKS

### HICKORY SHAFT

IPTS1	Multi-Tom Drum Stick/Hickory.....	\$17.25
IPTS2	Multi-Tom Drum Stick/Nylon Bead.....	23.50
IPTS2M	TS-2 Marching Multi-Stick/Nylon & Hard Felt.....	49.50
FS2M	FS-2 Marching Multi-Stick/Hickory & Hard Felt.....	41.75
FS2T	FS-2 Multi-Tom Stick "Shorty".....	16.75
FT1	Multi-Tom Mallet/Synthetic.....	46.00
FT2	Multi-Tom Mallet/Hard Felt.....	53.50
FT3	Multi-Tom Mallet/Soft.....	58.00
TSTJ	Tim Jackson Model #1 Multi-Tom Stick.....	30.00
TSTJ2	Tim Jackson Model #2 Multi-Tom Stick.....	30.00



## FIELD SERIES MULTI-TOM MALLETS

### ALUMINUM SHAFT

FT1AH	Multi-Tom Mallet/Synthetic (New Design).....	\$49.00
FT2A	Multi-Tom Mallet/Hard Felt.....	50.50
FT3A	Multi-Tom Mallet/Soft.....	55.00
FT4A	Multi-Tom Mallet/Large Synthetic.....	51.00

## FIELD SERIES MARCHING BASS MALLETS

### HARD FULCRUM NOTCH HANDLE

FB1	Marching Bass/Extra Small.....	\$54.25
FB2	Marching Bass/Small.....	56.25
FB3	Marching Bass/Medium.....	61.00
FB4	Marching Bass/Large.....	72.50
FB5	Marching Bass/Extra Large.....	81.50

### HARD TAPERED HANDLE

FBX1	Marching Bass/Extra Small.....	\$54.25
FBX2	Marching Bass/Small.....	56.25
FBX3	Marching Bass/Medium.....	61.00
FBX4	Marching Bass/Large.....	72.50
FBX5	Marching Bass/Extra Large.....	81.50

### SOFT TAPERED HANDLE

FBX1S	Marching Bass/Extra Small.....	\$59.50
FBX2S	Marching Bass/Small.....	61.50
FBX3S	Marching Bass/Medium.....	66.00
FBX4S	Marching Bass/Large.....	76.50
FBX5S	Marching Bass/Extra Large.....	84.75

## FIELD SERIES TIMPANI MALLETS

FST1	Timpani/Soft.....	\$46.00
FST2	Timpani/Medium Soft, General.....	46.00
FST3	Timpani/Medium, General.....	46.00
FST4	Timpani/Medium Hard, General.....	46.00
FST5	Timpani/Hard Felt, Ultra Staccato.....	37.50

# INNOVATIVE PERCUSSION



## SOLOIST SERIES

IP100	Soft Marimba/Birch.....	\$49.00B
IP200	Medium Soft Marimba/Birch.....	49.00B
IP240	Medium Marimba/Birch.....	49.00B
IP275	Medium Hard Legato/Birch.....	49.00B
IP300	Medium Hard Marimba/Birch.....	49.00B
IP400	Hard Marimba/Birch.....	49.00B
IP100N	Soft Marimba Mallets/Teal Yarn/Natural Handles.....	49.00B
IP200N	Medium Soft Marimba Mallets/Teal Yarn/Natural Handles.....	49.00B
IP240N	Medium Marimba Mallets/Teal Yarn/Natural Handles.....	49.00B
IP275N	Medium Hard Legato Marimba Mallets/Teal Yarn/ Natural Handles.....	49.00B
IP300N	Medium Hard Marimba Mallets/Teal Yarn/Natural Handles.....	49.00B
IP400N	Hard Marimba Mallets/Teal Yarn/Natural Handles.....	49.00B

## RATTAN SERIES

AA15	Anders Astrand Soft Vibraphone/Marimba.....	\$63.00B
AA20	Anders Astrand Medium Soft Vibraphone/Marimba.....	63.00B
AA25	Anders Astrand Medium Vibraphone/Marimba.....	63.00B
AA25H	Anders Astrand Medium Vibraphone/Marimba Heavy.....	63.00B
AA30	Anders Astrand Hard Vibraphone/Marimba.....	63.00B
AA35	Anders Astrand Wrapped Xylophone.....	63.00B
JT23	Jerry Tachoir Medium Vibraphone.....	63.00B
RS201	Soft Vibraphone/Marimba.....	58.00B
RS251	Medium Vibraphone/Marimba.....	58.00B
RS301	Hard Vibraphone/Marimba.....	58.00B

## BAMBOO TIMPANI MALLETS

IPBT1	Large Roller.....	\$81.00
IPBT2	Legato.....	81.00
IPBT3	Medium Legato.....	81.00
IPBT4	General.....	81.00
IPBT5	Medium Hard.....	81.00
IPBT6	Staccato.....	81.00
IPBT7	Ultra Staccato.....	81.00
IPBT8	Wood Ball.....	54.00B

## DAN MOORE SERIES MARIMBA/VIBRAPHONE MALLETS

DM18	Dan Moore Deep Marimba.....	\$63.00B
DM21	Dan Moore Medium Vibraphone/Marimba.....	63.00B
DM26	Dan Moore Medium Hard Vibraphone/Marimba.....	63.00B
DM28	Dan Moore Jazz Vibraphone.....	63.00B
DM31	Dan Moore Hard Vibraphone.....	63.00B

## JANIS POTTER SERIES

IP401	Soft Marimba.....	\$58.00B
IP402	Medium Soft Marimba.....	58.00B
IP403	Medium Marimba.....	58.00B
IP404	Medium Hard Marimba.....	58.00B
IP405	Hard Marimba.....	58.00B

## WILLIAM MOERSCH SERIES

IP501	Soft Marimba.....	\$58.00B
IP502	Medium Soft Marimba.....	58.00B
IP503	Medium Hard Marimba.....	58.00B
IP504	Hard Marimba.....	58.00B

## ROBIN ENGELMAN SERIES

IP702	Soft Ensemble/Yarn.....	\$63.00B
IP703	Medium Ensemble/Yarn.....	63.00B
IP704	Hard Ensemble/Yarn.....	63.00B
IP705	Soft Ensemble/Cord.....	63.00B
IP706	Medium Ensemble/Cord.....	63.00B
IP707	Hard Ensemble/Cord.....	63.00B

## MARK FORD SERIES

IP801	Legato Marimba/Soft.....	\$58.00B
IP802	Legato Marimba/Medium Soft.....	58.00B
IP803	Legato Marimba/Medium Hard.....	58.00B
IP804	Legato Marimba/Hard.....	58.00B
IP811	Strong Legato Marimba/Soft.....	58.00B
IP812	Strong Legato Marimba/Medium Soft.....	58.00B
IP813	Strong Legato Marimba/Medium Hard.....	58.00B
IP814	Strong Legato Marimba/Hard.....	58.00B

## LUDWIG ALBERT SERIES

IP3101	Extra Soft Marimba Rattan.....	\$63.00B
IP3102	Medium Extra Soft Marimba Rattan.....	63.00B
IP3104	Medium Soft Marimba Rattan.....	63.00B
IP3105	Medium Marimba Rattan.....	63.00B
IP3106	Medium Hard Marimba Rattan.....	63.00B
IP3107	Hard Marimba Rattan.....	63.00B
IP3108	Extra Hard Marimba Rattan.....	63.00B

(Add "B" to Model # for Birch Handles)

## SANDI RENNICK SERIES

IP4001	Soft Marimba/Birch.....	\$49.00B
IP4002	Medium Marimba/Birch.....	49.00B
IP4003	Hard Marimba/Birch.....	49.00B
IP4004	Wrapped Xylophone/Birch.....	49.00B

## JAMES ROSS SERIES

IP901	Tan - Soft Xylophone/Bell.....	\$43.00B
IP902	Red - Medium Soft Xylophone/Bell.....	43.00B
IP903	White - Dark Xylophone/Bell.....	43.00B
IP904	Green - Hard Xylophone/Bell.....	43.00B
IP905	Rust - Bright Xylophone/Bell.....	43.00B
IP906	Black - Brilliant Xylophone/Bell.....	43.00B
IP907	Small Brass Bell.....	43.00B
IP908	Medium Brass Bell.....	43.00B
IP909	Large Brass Bell.....	43.00B

## ORCHESTRAL SERIES

IPOS1	White Tape - Medium Soft Xylophone.....	\$43.00B
IPOS2	Black Tape - Full, Hard Xylophone.....	48.00B
IPOS3	Yellow Tape - Light, Articulate Xylophone.....	43.00B
IPOS4	Blue Tape - Full, Forte Xylophone/Glockenspiel.....	43.00B
IPOS5	Light Blue Tape - Full Glockenspiel.....	43.00B
IPOS6	Red Tape - Light Glockenspiel.....	38.00B
IPOS7	Green Tape - Very Bright Glockenspiel.....	38.00B
IPOS9	Grey Tape Medium Glockenspiel/Xylophone Mallets, Extremely Bright, Linen Phenolic, Rattan.....	50.00B
IPOS10	Practice Mallet.....	43.00B
IP1003X	Hard, Yarn, Marimba.....	49.00B
IP1008	Medium Dark, Xylophone.....	46.00B

## SHE E WU SERIES

WU1	Soft Marimba.....	\$58.00B
WU2	Medium Soft Marimba.....	58.00B
WU3	Medium Marimba.....	58.00B
WU4	Medium Hard Marimba.....	58.00B
WU4C	Medium Hard Concerta Marimba.....	58.00B
WU5	Hard Marimba.....	58.00B
WU6	Very Hard Marimba.....	58.00B

## NEBOJSA ZIVKOVIC MARIMBA SERIES

		Cedar	Rattan
NJZ1	Black Soft Cedar.....	\$64.00B	\$68.00B
NJZ2	Deep Blue Medium Soft Cedar.....	64.00B	68.00B
NJZ3	Lilac General Soft Cedar.....	64.00B	68.00B
NJZ4	Blue General Cedar.....	64.00B	68.00B
NJZ5	Sky Blue General Hard Cedar.....	64.00B	68.00B
NJZ6	Silver Hard Cedar.....	64.00B	68.00B
NJZ7	Canary Very Hard Cedar.....	64.00B	68.00B
NJZMT	Very Hard Multitone.....	64.00B	68.00B

(Add "R" to Model # for Rattan Handles)

## TOM RARICK SERIES

IP3001	Soft Marimba/Yarn.....	\$49.00B
IP3002	Medium Soft Marimba/Yarn.....	49.00B
IP3003	Medium Hard Marimba/Yarn.....	49.00B
IP3004	Hard Marimba/Yarn.....	49.00B
IP3005	Soft Vibraphone/Cord.....	49.00B
IP3006	Medium Vibraphone/Cord.....	49.00B
IP3007	Hard Vibraphone/Cord.....	49.00B

## FIELD SERIES

FS150	Soft Marimba/Birch.....	\$47.00B
FS150R	Soft Marimba/Rattan.....	52.00B
FS250	Hard Marimba/Birch.....	47.00B
FS250R	Hard Marimba/Rattan.....	52.00B
FS350	Very Hard Marimba/Birch.....	36.00B
FS350R	Very Hard Marimba/Rattan.....	43.00B
RFS320	Soft Vibraphone.....	54.00B
RFS420	Hard Vibraphone.....	54.00B
FS550	Extremely Hard Xylophone/Birch.....	36.00B
FS550R	Extremely Hard Xylophone/Rattan.....	43.00B
FS650	Hard Bell/Birch.....	36.00B

## ENSEMBLE SERIES

ENS10	Extra Soft/Rattan.....	\$46.00B
ENS15	Soft/Rattan.....	46.00B
ENS20	Medium Soft/Rattan.....	46.00B
ENS25	Medium Hard/Rattan.....	46.00B
ENS30	Hard/Rattan.....	46.00B
ENS35	Extra Hard/Rattan.....	52.00B

# INNOVATIVE PERCUSSION

## GLOBAL SERIES

<b>GS1</b>	Global Series Beaters/Large	\$21.00
<b>GS2</b>	Global Series Beaters/Small	17.00
<b>LSLD</b>	Lalo Davila Model / 7/16" Timbale (Pack of 4 Pair)	34.00
<b>LSLD1</b>	Lalo Davila Model/ 3/8" Timbale (Pack of 4 Pair)	34.00
<b>LSLD3</b>	Lalo Davila Model/ 1/2" Timbale (Pack of 4 Pair)	34.00

## STEEL DRUM SERIES ALUMINUM SHAFT

<b>IPSA1</b>	Lead	\$30.00
<b>IPSA2</b>	Double Tenor	30.00
<b>SA3</b>	Double Second	30.00
<b>SA4</b>	Guitar/Cello	34.00
<b>SA5</b>	Tenor Bass	36.00
<b>SA6</b>	Bass	36.00

## WALNUT SHAFT

<b>IPSW1</b>	Lead	\$24.00
<b>IPSW2</b>	Double Tenor	24.00
<b>IPSW3</b>	Double Second	24.00
<b>IPSW4</b>	Guitar/Cello	28.00
<b>IPSW6</b>	Bass	30.00

## NYLON TIP COMBO STICKS

<b>IP2BN</b>	Combo Model 2B w/nylon tip	\$16.50
<b>IP5AN</b>	Combo Model 5A w/nylon tip	16.50
<b>IP5BN</b>	Combo Model 5B w/nylon tip	16.50
<b>IP7AN</b>	Combo Model 7A w/nylon tip	16.50
<b>IPHBN</b>	Combo Model Hybrid w/nylon tip	16.50
<b>IPRKN</b>	Combo Model RockStick w/nylon tip	16.50

## REPLACEMENT COVERS

<b>IPCCB1</b>	CB-1 Replacement Cover	\$30.00
<b>IPCCG1</b>	CG-1 Replacement Cover	31.00
<b>IPCSM1</b>	Tips for SA1 & IPSW1	9.50 pr.
<b>CSM2</b>	Tips for SA2 & SW2	9.00 pr.
<b>CSM3</b>	Tips for SA3 & SW3	9.00 pr.
<b>CSM4</b>	Tips for SA4 & SW4	18.00 pr.

## CHRISTOPHER LAMB ORCHESTRAL SERIES

<b>CLX1</b>	Medium Soft Xylophone Mallets - 1 1/8" Rubber, Weighted, Dark Grey, Rattan	\$54.00B
<b>CLX2</b>	Medium Dark Xylophone Mallets - 1" Synthetic Top, Weighted, Orange, Rattan	54.00B
<b>CLX3</b>	Hard Xylophone Mallets - 1" Synthetic Top, Weighted, Burgundy, Rattan	54.00B
<b>CLX4</b>	Medium Bright Xylophone Mallets - 1" Nylon Top, Weighted, Blue, Rattan	54.00B
<b>CLX5</b>	Hard Bright Xylophone Mallets - 1 1/8" Nylon Top, Purple, Rattan	41.00B
<b>CLX6</b>	Hard Dark Xylophone Mallets - 1 1/8" Nylon Top, Weighted, Graphite, Rattan	54.00B
<b>CLX7</b>	Medium Xylophone Mallets - 32 x 18mm Rosewood Disk, Rattan	86.00B
<b>CLX8</b>	Large Xylophone Mallets - 35 x 18mm Rosewood Disk, Rattan	86.00B
<b>CLX9</b>	Barrel Core Xylophone Mallets - 30mm Rosewood Core, Rattan	86.00B

## PLUS CHEUNG MARIMBA SERIES

<b>PIUS1</b>	Soft Bass Marimba Mallets, White Yarn, Rattan	\$61.00B
<b>PIUS2</b>	Medium Soft Bass Marimba Mallets, White Yarn, Rattan	61.00B
<b>PIUS3</b>	Medium General Marimba Mallets, White Yarn, Rattan	61.00B
<b>PIUS4</b>	Medium Hard Marimba Mallets, White Yarn, Rattan	61.00B
<b>PIUS5</b>	Hard Marimba Mallets, White Yarn, Rattan	61.00B
<b>PIUS6</b>	Very Hard Marimba Mallets, White Yarn, Rattan	61.00B
<b>PIUSG6</b>	Graduated Set of 1, PIUS1, PIUS3 and 1 PIUS4 Mallets	126.00B

## COMBO DRUMSTICKS

<b>IPBB1</b>	Bob Breithaupt Model/Maple	\$16.50
<b>IPBB2</b>	Robert Breithaupt Hickory	16.50
<b>IP2B</b>	Combo Model 2B	15.25
<b>IPCR</b>	Cool Ride	15.25
<b>IPSR</b>	Smooth Ride	15.25
<b>IPRKN</b>	Combo Rock Nylon	16.50
<b>IPES1</b>	Ed Soph Model/Maple	16.50
<b>IPES2</b>	Ed Soph Model/White Hickory	16.50
<b>IP5A</b>	Combo Model 5A	15.25
<b>IP5AM</b>	Multi Stick IP-5A, with a felt ball on the butt end	35.00
<b>IP5B</b>	Combo Model 5B	15.25
<b>IPHB</b>	Combo Model Hybrid	15.25
<b>IPHBN</b>	Combo Model Hybrid Nylon	16.50
<b>IPJZ</b>	IP-JZ Big Band Combo Stick, features an elongated bead	15.25

## JIM CASELLA SERIES

<b>IP1001</b>	Soft Marimba/Yarn	\$49.00B
<b>IP1002</b>	Medium Marimba/Yarn	49.00B
<b>IP1003</b>	Hard Marimba/Yarn	49.00B
<b>IP1004</b>	Soft Vibraphone/Cord	58.00B
<b>IP1005</b>	Medium Vibraphone/Cord	58.00B
<b>IP1006</b>	Hard Vibraphone/Cord	58.00B
<b>IP1007</b>	Medium-Dark Xylophone Large	46.00B
<b>IP1008</b>	Medium-Dark Xylophone Medium	50.00B

## JAMES ANCONA SERIES

<b>IP2001</b>	Extra Soft Marimba/Yarn	\$49.00B
<b>IP2002</b>	Soft Marimba/Yarn	49.00B
<b>IP2003</b>	Medium Marimba/Yarn	49.00B
<b>IP2004</b>	Hard Marimba/Yarn	49.00B
<b>IP2005</b>	Medium Soft Vibraphone/ Marimba/Cord	58.00B
<b>IP2006</b>	Medium Hard Vibraphone/ Marimba/Cord	58.00B
<b>IP2007</b>	Hard Vibraphone/Marimba/Cord	58.00B

## ENSEMBLE SERIES

<b>ENS260</b>	Latex Covered/Birch	\$40.00B
<b>ENS260R</b>	Latex Covered/Rattan	47.00B
<b>ENS360</b>	Hard Rubber/Birch	35.00B
<b>ENS360R</b>	Hard Rubber/Rattan	42.00B
<b>ENS760</b>	Aluminum Crotale/Birch	32.00B
<b>ENS760R</b>	Aluminum Crotale/Rattan	42.00B

## CASEY CANGELOSI MARIMBA SERIES

<b>CGL1</b>	Heavy Bass Marimba Mallets, Black Cord, Birch	\$58.00B
<b>CGL1Y</b>	Heavy Bass Marimba Mallets, Black Yarn, Birch	58.00B
<b>CGL2</b>	Rich Articulate Bass Marimba Mallets, Dark Purple Cord, Birch	58.00B
<b>CGL2Y</b>	Rich Articulate Bass Marimba Mallets, Dark Purple Yarn, Birch	58.00B
<b>CGL3</b>	Low-Mid Register Marimba Mallets, Royal Blue Cord, Birch	58.00B
<b>CGL4</b>	Mid-High Register Marimba Mallets, White Cord, Birch	58.00B

# BLACK SWAMP PERCUSSION

## TAM TAM GONG MALLETS

<b>BSGT3</b>	Medium, 4 Striking Faces	\$78.00*
<b>BSGT5</b>	Large, 4 Striking Faces	92.00*
<b>BSGTR</b>	Pair of Tam Tam Rollers	180.00*

## TRIANGLES

<b>BSAT6</b>	6" Artisan Triangle (Steel)	\$126.00*
<b>BSAT8</b>	8" Artisan Triangle (Steel)	132.00*

## TRIANGLE ACCESSORIES

<b>BSTRHANG</b>	Triangle Holder, hangs on music stand	\$59.00
<b>BSTRCLIP</b>	Triangle Clip, clips on music stand	84.00
<b>BSTGP</b>	Triangle Gig Pack, holds triangles, beaters, clips	67.00
<b>BSSET3</b>	3 Beaters with nylon case	92.00
<b>BSSET6</b>	6 Beaters with nylon case	176.00
<b>BSSPSET1</b>	Set of 3 Beaters (one each model) with nylon case	110.00



## CONCERT CASTANETS

<b>BSPCC3RW</b>	Large Bloodwood Castanets on handles, pair	\$178.00*
<b>BSCMF</b>	Castanet Mounting Frame (machine only)	132.00*

## LOG DRUMS

<b>BSLOG1</b>	Small, 20" Long	\$398.00*
<b>BSLOG2</b>	Medium, 25" Long	425.00*
<b>BSLOG3</b>	Large, 30" Long	452.00*
<b>BSLOG4</b>	Extra Large, 38" Long	478.00*
<b>BSLOGSET</b>	Set of all four log drums	1705.00*
<b>BSLDCASE1</b>	Soft case for LOG1	\$113.00*
<b>BSLDCASE2</b>	Soft case for LOG2	120.00*
<b>BSLDCASE3</b>	Soft case for LOG3	128.00*
<b>BSLDCASE4</b>	Soft case for LOG4	136.00*

\*CALL FOR DEALER COST ON BLACK SWAMP

## BENTWOOD TEMPLE BLOCKS

<b>BSTBSET5</b>	Set of 5 temple blocks with mount	\$758.00*
<b>BSTBSET6</b>	Set of 6 temple blocks with mount	905.00*
<b>BSTBCASE</b>	Travel case for TBSETS and TBSET6	429.00*

## SOUNDART SERIES™ TAMBOURINES SOLID ASH SHELL/CALF HEAD W/CASE

<b>BSTD1</b>	Double Row 10" - Chromium 25™ Jingles	\$233.00*
<b>BSTD2</b>	Double Row 10" - Phos Bronze Jingles	233.00*
<b>BSTD3</b>	Double Row 10" - German Silver Jingles	240.00*
<b>BSTC1</b>	Double Row 10" - Chromium/Bronze Jingle Mix	233.00*
<b>BSTC2</b>	Double Row 10" - Chromium/Silver Jingles	240.00*
<b>BSTC1S</b>	Double Row 10" - Chromium/ Bronze Jingle Remo HD	220.00*

## YAMAHA



**FIELD-MASTER MARCHING BASS DRUM MALLETS (Aluminum Shafts)**

<b>MBM100</b>	Hard Felt, small.....	<b>\$46.00D</b>
<b>MBM200</b>	Hard Felt, medium.....	<b>58.00D</b>
<b>MBM300</b>	Hard Felt, large.....	<b>72.00D</b>
<b>MBM400</b>	Hard Felt, extra large.....	<b>78.00D</b>
<b>MBM500</b>	Hard Felt, jumbo.....	<b>82.00D</b>

**FIELD-MASTER MARCHING TOM MALLETS (Aluminum Shafts)**

<b>MTM100</b>	Hard Felt.....	<b>\$39.00D</b>
<b>MTM150</b>	Soft Pile.....	<b>53.00D</b>
<b>MTM250</b>	Lexan Ball.....	<b>34.25D</b>
<b>MTM300</b>	The "Cookie" Mallet, poly disc.....	<b>34.25D</b>
<b>MTM301</b>	The "Cookie" Mallet, Heavy.....	<b>39.00D</b>

## CLEVELANDER TIMPANI STICKS



<b>CDB1</b>	Wood, Bamboo Handle.....	<b>\$39.55 pr.</b>
<b>CDB2</b>	Ultra Hard, Bamboo Handle.....	<b>49.50 pr.</b>
<b>CDB3</b>	Small Classic Ball, Bamboo Handle.....	<b>77.55 pr.</b>
<b>CDB4</b>	Medium Classic Ball, Bamboo Handle.....	<b>77.55 pr.</b>
<b>CDB5</b>	Large Classic Ball, Bamboo Handle.....	<b>77.55 pr.</b>
<b>CDB7</b>	Medium Cartwheel, Bamboo Handle.....	<b>77.55 pr.</b>
<b>CDB8</b>	Small Cartwheel, Bamboo Handle.....	<b>77.55 pr.</b>
<b>CDB9</b>	Rollerball, Bambo Handle.....	<b>89.49 pr.</b>

## CB MALLETS



**Unwound**

<b>702</b>	Soft/Tan.....	<b>\$22.10</b>
<b>703</b>	Med. Soft/Tan.....	<b>22.10</b>
<b>704</b>	Med. Lt. Green.....	<b>22.10</b>
<b>706</b>	Hard/Gray.....	<b>22.10</b>
<b>709</b>	Brass.....	<b>22.10</b>
<b>710</b>	Plastic Hard.....	<b>22.10</b>

**Yarn Wound**

<b>711</b>	Hard/Yellow.....	<b>\$36.40</b>
<b>712</b>	Med. Hard/Green.....	<b>36.40</b>
<b>713</b>	Med. Blue.....	<b>36.40</b>
<b>714</b>	Med. Soft/Red.....	<b>38.50</b>
<b>715</b>	Soft/Aqua.....	<b>36.40</b>

**Classroom**

<b>CB3349</b>	Bi-Tone Mallet.....	<b>\$9.00</b>
<b>CBE18</b>	Bell Mallets Phenolic Head.....	<b>9.90</b>
<b>CB3343</b>	Duotone Mallets.....	<b>9.00</b>
<b>V240</b>	Vic Firth Bell Mallets.....	<b>9.25</b>

## GREAT DANE BEATERS



**MARIMBA**

<b>3227</b>	Hard Rubber Head. Rattan Stick.....	<b>\$10.00 pr.</b>
<b>TR9306</b>	Wood Ball, Delrin Shaft.....	<b>3.30 pr.</b>
<b>TR9312</b>	Rubber Ball, Delrin Shaft.....	<b>2.95 pr.</b>

**BELL LYRA**

<b>1740R</b>	Fiberglass.....	<b>\$13.00 pr.</b>
<b>1740RBK</b>	Black, Fiberglass.....	<b>13.00 pr.</b>
<b>CBE18</b>	Phenolic Head, Wood Shaft.....	<b>9.90 pr.</b>

## DUPLEX CORPS MALLETS

<b>3150</b>	Bass Drum Mallets. Aluminum shafts, 1 1/2" felt head.....	<b>\$49.50 pr.</b>
<b>3151</b>	Bass Drum Mallets. Aluminum shafts 2" felt head.....	<b>57.55 pr.</b>
<b>3152</b>	Bass Drum Mallets. Aluminum shafts, 2 1/2" felt heads.....	<b>67.50 pr.</b>
<b>3054</b>	2" Solid Felt Head. Stick Length 13 3/4".....	<b>29.50 pr.</b>
<b>3157</b>	Bass Drum Mallets. Hardwood shafts, 2 1/2" felt heads.....	<b>75.00 pr.</b>
<b>3160</b>	Timpani Mallets. Aluminum shafts, 1/2" felt heads.....	<b>35.05 pr.</b>
<b>3162</b>	Timpani Mallets, Black Hard Rubber.....	<b>35.05 pr.</b>
<b>3170</b>	Bell Lyra Mallets. Black plastic shaft. 1" acrylic heads.....	<b>32.55 pr.</b>

## DRUM BEATERS



**TIMPANI BEATERS**

<b>3051</b>	1 1/4" White Felt Head. Stick Length 13 1/2".....	<b>\$54.50 pr.</b>
<b>3052</b>	1 1/16" Soft Felt Head. Stick Length 13 1/2".....	<b>54.50 pr.</b>

**BASS DRUM BEATERS**

<b>3035</b>	Soft Lambswool Head.....	<b>\$29.95 ea.</b>
<b>3036</b>	Soft Lambswool Head, Strap Handle.....	<b>34.95 ea.</b>
<b>3037</b>	Double Head Short.....	<b>34.00 ea.</b>
<b>3038</b>	Double Head Long.....	<b>34.00 ea.</b>

**TENOR DRUM BEATERS**

<b>3048</b>	1 3/4" Solid Felt Head. Stick Length 12 1/2".....	<b>\$52.50 pr.</b>
-------------	---	--------------------

## ON/STAGE DRUM STICKS



<b>HN2B</b>	2BW Hickory Nylon.....	<b>\$4.65 pr.</b>	<b>MN2B</b>	2B Maple Nylon.....	<b>\$4.15 pr.</b>	<b>AHN2B</b>	2B Ame/Hic Nylon.....	<b>\$6.15 pr.</b>
<b>HN5A</b>	5AN Hickory Nylon.....	<b>4.65 pr.</b>	<b>MN5A</b>	5A Maple Nylon.....	<b>4.15 pr.</b>	<b>AHN5A</b>	5A Ame/Hic Nylon.....	<b>6.15 pr.</b>
<b>HN5B</b>	5BN Hickory Nylon.....	<b>4.65 pr.</b>	<b>MN5B</b>	5B Maple Nylon.....	<b>4.15 pr.</b>	<b>AHN5B</b>	5B Ame/Hic Nylon.....	<b>6.15 pr.</b>
<b>HN7A</b>	7AN Hickory Nylon.....	<b>4.65 pr.</b>	<b>MN7A</b>	7A Maple Nylon.....	<b>4.15 pr.</b>	<b>AHN7A</b>	7A Ame/Hic Nylon.....	<b>6.15 pr.</b>
<b>HW2B</b>	2BW Hickory Wood.....	<b>4.65 pr.</b>	<b>MW2B</b>	2B Maple Wood.....	<b>4.15 pr.</b>	<b>AHW2B</b>	2B Ame/Hic Wood.....	<b>6.15 pr.</b>
<b>HW5A</b>	5AW Hickory Wood.....	<b>4.65 pr.</b>	<b>MW5A</b>	5A Maple Wood.....	<b>4.15 pr.</b>	<b>AHW5A</b>	5A Ame/Hic Wood.....	<b>6.15 pr.</b>
<b>HW5B</b>	5BW Hickory Wood.....	<b>4.65 pr.</b>	<b>MW5B</b>	5B Maple Wood.....	<b>4.15 pr.</b>	<b>AHW5B</b>	5B Ame/Hic Wood.....	<b>6.15 pr.</b>
<b>HW7A</b>	7AW Hickory Wood.....	<b>4.65 pr.</b>	<b>MW7A</b>	7A Maple Wood.....	<b>4.15 pr.</b>	<b>AHW7A</b>	7A Ame/Hic Wood.....	<b>6.15 pr.</b>

# MIKE BALTER MALLET

## KEYBOARD MALLET SERIES

Model		Birch or Black Birch handles	Fiberglass Handles	Rattan Handles	Model	Birch or Black Birch handles	Fiberglass Handles	Rattan Handles			
<b>UNWOUND SERIES</b>				<b>PERFORMING ARTIST SERIES - Solo Marimba Mallets</b>							
MB1	Black Rubber	ES	\$32.00 pr.	\$40.00 pr.	\$48.00 pr.	MB52	Grey Yarn	H	\$53.00 pr.	N/A	68.00 pr.
MB2	Tan Rubber	S	32.00 pr.	40.00 pr.	48.00 pr.	MB53	Grey Yarn	M	53.00 pr.	N/A	68.00 pr.
MB3	Brown Rubber	MS	32.00 pr.	40.00 pr.	48.00 pr.	MB54	Grey Yarn	S	53.00 pr.	N/A	68.00 pr.
MB4	Lt Green Rubber	M	32.00 pr.	40.00 pr.	48.00 pr.	MB55	Grey Yarn	ES	53.00 pr.	N/A	68.00 pr.
MB5	Dk Green Rubber	MH	32.00 pr.	40.00 pr.	48.00 pr.	<b>MUSHROOM HEAD SERIES</b>					
MB6	Grey Rubber	H	32.00 pr.	40.00 pr.	48.00 pr.	MB61	Yellow Yarn	MH	\$49.00 pr.		\$64.00 pr.
MB7	1 1/4" Maple	H	32.00 pr.	40.00 pr.	48.00 pr.	MB62	Yellow Cord	MH	49.00 pr.		64.00 pr.
MB8	3/8" Rosewood	H	32.00 pr.	40.00 pr.	48.00 pr.	MB63	Yellow Yarn	MS	49.00 pr.		64.00 pr.
MB8A	1 1/4" Rosewood	H	32.00 pr.	40.00 pr.	48.00 pr.	MB64	Yellow Cord	MS	49.00 pr.		64.00 pr.
MB9	3/8" Brass	H	32.00 pr.	40.00 pr.	48.00 pr.	<b>TRADITION PLUS SERIES - Rubber Wound Marimba Mallets</b>					
MB9A	3/8" Aluminum	MH	32.00 pr.	40.00 pr.	48.00 pr.	MB71	Yellow Trim	H	\$44.00 pr.	N/A	58.00 pr.
MB10	1 1/4" Phenolic	EH	32.00 pr.	40.00 pr.	48.00 pr.	MB72	Green Trim	MH	44.00 pr.	N/A	58.00 pr.
MB10A	3/8" Phenolic	H	32.00 pr.	40.00 pr.	48.00 pr.	MB73	Blue Trim	M	44.00 pr.	N/A	58.00 pr.
<b>ENSEMBLE SERIES - Yarn Wound Marimba Mallets</b>				<b>CONTEMPORARY SERIES - Yarn Wound Marimba Mallets</b>							
MB11	Yellow Yarn	H	\$45.00 pr.	\$52.00 pr.	\$60.00 pr.	MB81	Purple Yarn	H	\$50.00 pr.	N/A	\$65.00 pr.
MB12	Green Yarn	MH	45.00 pr.	52.00 pr.	60.00 pr.	MB82	Green Yarn	MH	50.00 pr.	N/A	65.00 pr.
MB13	Blue Yarn	M	45.00 pr.	52.00 pr.	60.00 pr.	MB83	Rose Yarn	M	50.00 pr.	N/A	65.00 pr.
MB14	Red Yarn	MS	45.00 pr.	52.00 pr.	60.00 pr.	MB84	Blue Yarn	MS	50.00 pr.	N/A	65.00 pr.
MB15	Aqua Yarn	S	45.00 pr.	52.00 pr.	60.00 pr.	MB85	Wine Yarn	S	50.00 pr.	N/A	65.00 pr.
MB16	Orange Yarn	ES	45.00 pr.	52.00 pr.	60.00 pr.	MB86	Burgundy Yarn	ES	50.00 pr.	N/A	65.00 pr.
MB17	Lt Blue Yarn	ES	47.00 pr.			<b>MARCHING KEYBOARD SERIES</b>					
MB18	Lt. Green Yarn	Bass	49.00 pr.			MB91	1 1/8" Poly	MH	\$32.00 pr.	\$40.00 pr.	\$48.00 pr.
<b>PRO VIBE SERIES - Cord Wound Vibe Mallets</b>				<b>GRANDIOSO UNWOUND SERIES</b>							
MB21	Yellow Cord	H	\$49.00 pr.	\$56.00 pr.	\$64.00 pr.	MB101	Black Rubber	ES	\$33.00 pr.	N/A	\$49.00 pr.
MB22	Green Cord	MH	49.00 pr.	56.00 pr.	64.00 pr.	MB102	Tan Rubber	S	33.00 pr.	N/A	49.00 pr.
MB23	Blue Cord	M	49.00 pr.	56.00 pr.	64.00 pr.	MB103	Brown Rubber	MS	33.00 pr.	N/A	49.00 pr.
MB24	Red Cord	S	49.00 pr.	56.00 pr.	64.00 pr.	MB104	Lt Green Rubber	M	33.00 pr.	N/A	49.00 pr.
MB25	Silver Cord	Jazz	49.00 pr.	56.00 pr.	64.00 pr.	MB105	Dk Green Rubber	MH	33.00 pr.	N/A	49.00 pr.
<b>WIDE BAR SERIES - Yarn Wound Vibe Mallets</b>				<b>ULTIMATE SERIES</b>							
MB31	Beige Yarn	H	\$47.00 pr.	N/A	\$62.00 pr.	MB111	Yellow Cord	EH	\$49.00 pr.	N/A	\$64.00 pr.
MB32	Pink Yarn	M	47.00 pr.	N/A	62.00 pr.	MB112	Green Cord	H	49.00 pr.	N/A	64.00 pr.
MB33	Gold Yarn	S	47.00 pr.	N/A	62.00 pr.	MB113	Blue Cord	MH	49.00 pr.	N/A	64.00 pr.
<b>ARTIST SERIES</b>				<b>SUPER VIBE SERIES</b>							
MB40	Dick Sisto	M	N/A	N/A	\$66.00 pr.	MB121	Yellow Cord	EH	\$51.00 pr.	N/A	\$66.00 pr.
MB40Q	Dick Sisto	M	N/A	11	68.00 pr.	MB122	Green Cord	H	51.00 pr.	N/A	66.00 pr.
MB41	Arthur Lipner	M	N/A	N/A	60.00 pr.	MB123	Blue Cord	MH	51.00 pr.	N/A	66.00 pr.
MB46	Tony Miceli	MH	N/A	N/A	66.00 pr.	MB124	Red Cord	M	51.00 pr.	N/A	66.00 pr.
MB46A	Tony Miceli	MS	N/A	N/A	66.00 pr.	MB125	Aqua Cord	MS	51.00 pr.	N/A	66.00 pr.
MB47	Joe Locke	H	N/A	N/A	66.00 pr.	MB126	Orange Cord	S	51.00 pr.	N/A	66.00 pr.
MB48	Joe Locke	M	N/A	N/A	66.00 pr.	<b>SHADOW SERIES</b>					
MB49	Joe Locke	MS	N/A	N/A	66.00 pr.	MB221BB	Yellow Trim	H	\$50.00 pr.		
MB50	Christos Rafalides	MH	N/A	N/A	66.00 pr.	MB222BB	Green Trim	MH	50.00 pr.		
<b>HIGH VOLUME SERIES</b>				<b>SHADOW SERIES</b>							
MB191	1-3/8" Poly	MH	\$38.00 pr.		\$46.00 pr.	MB223BB	Blue Trim	M	50.00 pr.		
MB192	1-3/8" Poly	H	40.00 pr.		46.00 pr.	MB224BB	Red Trim	S	50.00 pr.		
MB193	1-3/8" PVC	H	43.00 pr.		56.00 pr.						
MB194	White Cord	MS	50.00 pr.		64.00 pr.						
MB195	White Cord	MH	54.00 pr.		64.00 pr.						

When ordering keyboard mallets indicate handle choice by adding the following suffix to each model number:  
**B** for Satin Birch, **BB** for Black Birch, **F** for Two-Stage Fiberglass, **R** for Rattan



# MIKE BALTER MALLET



## BALTER BASICS

Model			Birch Handles
MBBB1	Yellow Yarn	Hard	\$30.00 pr.
MBBB2	Blue Yarn	Medium	30.00 pr.
MBBB3	Red Yarn	Soft	30.00 pr.
MBBB4	Yellow Cord	Hard	30.00 pr.
MBBB5	Blue Cord	Medium	30.00 pr.
MBBB6	Red Cord	Soft	30.00 pr.
MBBB7	Yellow Rubber	Hard	22.00 pr.
MBBB8	Blue Rubber	Medium	22.00 pr.
MBBB9	Red Rubber	Soft	22.00 pr.
MBBB10	1" PVC	Hard	22.00 pr.
MBBB11	1" Poly	Medium Hard	22.00 pr.
MBBB12	Round Brass	Hard	22.00 pr.
MBBB24	Black Cord	Hard	32.00 pr.
MBBB25	Black Cord	Medium	32.00 pr.
MBBB26	Black Cord	Soft	32.00 pr.
MBBB27	Black Rubber	Medium	24.00 pr.

## CHORALE SERIES/MARIMBA

Model			Birch Handles
MB211	Yellow Microfiber – Hard		\$50.00 pr.
MB212	Green Microfiber – Med. Hard		50.00 pr.
MB213	Blue Microfiber – Medium		50.00 pr.
MB214	Red Microfiber – Med. Soft		50.00 pr.
MB215	Aqua Microfiber – Soft		50.00 pr.
MB216	Orange Microfiber – Extra Soft		50.00 pr.

## TIMPANI

Model			
MBT0	Solid Felt		\$48.00 pr.
MBT1	Ultra Staccato – Yellow Trim		46.00 pr.
MBT2	Staccato – Green Trim		48.00 pr.
MBT3	General – Blue Trim		48.00 pr.
MBT4	Legato – Red Trim		48.00 pr.
MBT5	Wood		34.00 pr.

## CONCERT BASS DRUM

Model			
MBCBD1	Solid Felt – Yellow Trim		\$49.00 ea.
MBCBD2	Small – Green Trim		52.00 ea.
MBCBD3	Medium – Blue Trim		54.00 ea.
MBCBD4	Large – Red Trim		57.00 ea.
MBCBD5	Rollers – Orange Trim		75.00 ea.
MBCBD6	Double Header		77.00 ea.

## GONG

Model			
MBGM1	General (Black Yarn)		\$52.00 ea.
MBGM2	Heavy (Brown Yarn)		56.00 ea.
MBGM3	Light (Grey Yarn)		48.00 ea.
MBWG1	Wind Gong (Blue Yarn)		34.00 ea.

## CHIME

Model			
MBCM1	Small (1 1/4")		\$38.00 ea.
MBCM2	Medium (1 1/2")		40.00 ea.
MBCM3	Large (1 3/4")		42.00 ea.

## SUSPENDED CYMBAL

MBSC1	MH	\$47.00 pr.
MBSC2	MS	47.00 pr.

## LATEX COVERED SERIES

			Birch Handles	Rattan Handles
MB171	1 1/4" Head	H	\$38.00 pr.	\$52.00 pr.
MB172	1 1/6" Head	MH	38.00 pr.	52.00 pr.
MB173	1 3/8" Head	M	38.00 pr.	52.00 pr.
MB174	1 1/6" Head	MS	38.00 pr.	52.00 pr.
MB175	1 1/6" Head	S	38.00 pr.	52.00 pr.

## BAND DIRECTOR'S SPECIAL

MBBDS1	Special Pre-Pack (1 each BB2, BB8, BB10, BB12, T3, MBMP)	\$135.00
MBBDS2	Special Pre-Pack (2 BB22, 2 BB25, 1 BB27, 1 T2, 1 MBMP)	185.00

## LOUIE BELLSON DRUMSET SERIES

Model		
MBLB2	Stick Mallet	\$52.00 pr.
MBLB3	Brush Mallet	52.00 pr.
MBLB4	Stick Brush	34.00 pr.
MBLB5	Jingle Stick	22.00 pr.
MBLB6	Brustick®	46.00 pr.

## TRIANGLE BEATERS

MBTB	Full Set with Case	\$110.00 ea.
MBSB	Single 4-N-1 Beater	44.00 ea.

## GLOCK / BELL / XYLO SERIES MALLET

Model			Birch Handles	Rattan Handles
MBG1	1" Poly	MS	N/A	\$48.00 pr.
MBG2	1" Lexan	MH	N/A	54.00 pr.
MBG3	1" Nylon	M-MH	N/A	48.00 pr.
MBG4	1" PVC	H	N/A	48.00 pr.
MBG5	3/8" Round Brass	H	N/A	48.00 pr.
MBG6	3/8" Round Alum.	MH	N/A	48.00 pr.
MBX1	1 1/8" Nylon	MH	N/A	48.00 pr.
MBX2	1 1/8" PVC	H	N/A	48.00 pr.
MBX3	1 1/4" Sarlink	MH	N/A	48.00 pr.
MBX4	1 1/4" Santoprene	M	N/A	48.00 pr.

## MARCHING

Model		
TIMP-TOM		
MBMM1	Nylon	\$49.00 pr.
MBMM2	Lexan	49.00 pr.
MBMM3	Felt	49.00 pr.

## FELT BASS DRUM

MBMBD1	Small Felt	\$56.00 pr.
MBMBD2	Medium Felt	60.00 pr.
MBMBD3	Large Felt	63.00 pr.
MBMBD4	X-Large Felt	69.00 pr.

## PUFF BASS DRUM

MBMBD6	Medium Puff	\$63.00 pr.
MBMBD7	Large Puff	68.00 pr.
MBMBD8	X-Large Puff	73.00 pr.

## MALLET CASES

MBMBMP	Mallet Pouch (6-10 Pair)	\$15.00 ea.
MBMBMB	Mallet Bag (40-50 Pair)	50.00 ea.
MBMBMC	Carry-All (60-75 Pair)	85.00 ea.

## UNIVERSAL SERIES

			Birch Handles	Rattan Handles
MB181	Brown Yarn	H-EH	\$50.00 pr.	\$65.00 pr.
MB182	Brown Yarn	MH-H	50.00 pr.	65.00 pr.
MB183	Brown Yarn	M-MH	50.00 pr.	65.00 pr.
MB184	Brown Yarn	MS-M	50.00 pr.	65.00 pr.
MB185	Brown Yarn	S-MS	50.00 pr.	65.00 pr.
MB186	Brown Yarn	ES-S	50.00 pr.	65.00 pr.
MB187	Brown Yarn	EES-ES	50.00 pr.	65.00 pr.



# LUDWIG/MUSSER MALLETS



## TIMPANI MALLETS

<b>LL304</b>	Ultra-Soft Pile Payson Model .....	<b>\$49.35B pr.</b>
<b>LL305</b>	Soft Payson Model.....	<b>49.35B pr.</b>
<b>LL306</b>	Medium Payson Model.....	<b>49.35B pr.</b>
<b>LL307</b>	Hard Payson Model.....	<b>49.35B pr.</b>

## MUSSER KEYBOARD MALLETS-TWO STEP HANDLE

<b>LM1</b>	Rubber, Soft, 1", Yellow .....	<b>\$34.65B pr.</b>
<b>LM2</b>	Rubber, Medium, 1", Red.....	<b>34.65B pr.</b>
<b>LM3</b>	Rubber, Medium-Hard, 1", Blue.....	<b>34.65B pr.</b>
<b>LM4</b>	Rubber, Hard, 1", Gray.....	<b>34.65B pr.</b>
<b>LM5</b>	Phenolic, Hard, 1", Brown.....	<b>34.65B pr.</b>
<b>LM6</b>	Yarn, Hard, 1", Red.....	<b>49.35B pr.</b>
<b>LM7</b>	Yarn, Medium, 1", Blue.....	<b>48.30B pr.</b>
<b>LM8</b>	Yarn, Medium-Soft, 1", Yellow.....	<b>48.30B pr.</b>
<b>LM9</b>	Yarn, Soft, 1 1/8", Gray.....	<b>48.30B pr.</b>
<b>LM10</b>	Yarn, Soft, 1 1/4", Gray.....	<b>52.55B pr.</b>
<b>LM11</b>	Yarn, Soft, 1", Green.....	<b>49.35B pr.</b>
<b>LM12</b>	Yarn, Very Soft, 1 3/8", Gray.....	<b>64.05B pr.</b>
<b>LM13</b>	Rubber, Medium-Soft, 1 1/4", Yellow.....	<b>34.65B pr.</b>
<b>LM14</b>	Brass, Very Hard, 5/8", Gold.....	<b>26.25B pr.</b>
<b>LM15</b>	Wood, Hard, 1", Maple.....	<b>26.25B pr.</b>
<b>LM16</b>	Cord, Hard, 1", Red.....	<b>73.50B pr.</b>
<b>LM17</b>	Cord, Medium, 1", Blue.....	<b>68.25B pr.</b>
<b>LM18</b>	Cord, Soft, 1", Yellow.....	<b>69.30B pr.</b>
<b>LM19</b>	Yarn, Soft, 1 3/8", Natural.....	<b>57.75B pr.</b>
<b>LM22</b>	Rubber, Hard, 1 1/8", Gray.....	<b>34.65B pr.</b>
<b>LM23</b>	Lexan, Very Hard, 1 1/8", Clear.....	<b>45.15B pr.</b>
<b>LM24</b>	Phenolic, Hard, 1 1/8", Black.....	<b>34.65B pr.</b>
<b>LM25</b>	Rubber, Medium-Soft, 1", Black.....	<b>34.65B pr.</b>
<b>LM27</b>	Cord, Medium-Hard, 1 1/4", Red.....	<b>107.10B pr.</b>
<b>LM28</b>	Phenolic, Hard, 1", Black.....	<b>34.65B pr.</b>
<b>LM29</b>	Cord, Medium, 1 1/4", Yellow.....	<b>107.10B pr.</b>

## MUSSER KEYBOARD MALLETS-BIRCH HANDLE

<b>LM401</b>	Rubber, Soft, 1", Yellow .....	<b>\$30.45B pr.</b>
<b>LM402</b>	Rubber, Medium, 1", Red.....	<b>30.45B pr.</b>
<b>LM403</b>	Rubber, Medium Hard, 1", Blue.....	<b>30.45B pr.</b>
<b>LM404</b>	Rubber, Hard, 1", Gray.....	<b>30.45B pr.</b>
<b>LM407</b>	Yarn, Medium, 1", Blue.....	<b>59.85B pr.</b>
<b>LM408</b>	Yarn, Medium-Soft, 1", Yellow.....	<b>59.85B pr.</b>
<b>LM410</b>	Yarn, Soft, 1 1/4", Gray.....	<b>64.05B pr.</b>
<b>LM423</b>	Lexan, Very Hard, 1 1/8", Clear.....	<b>39.90B pr.</b>
<b>LM428</b>	Phenolic, Hard, 1", Black.....	<b>30.45B pr.</b>
<b>LM4225</b>	Poly, Medium-Hard, 1", White.....	<b>33.60B pr.</b>
<b>LM4226</b>	Poly, Medium-Hard, 1 1/8", White.....	<b>33.60B pr.</b>



## CONCERT BASS DRUM AND GONG MALLETS

<b>LL308</b>	Payson "Sostenuto", Brown Soft.....	<b>\$49.35B ea.</b>
<b>LL309</b>	Payson "Roller", Brown Soft Pile.....	<b>64.05B pr.</b>
<b>LL310</b>	Payson General, White Soft Felt.....	<b>48.00B ea.</b>
<b>LL319</b>	Wood Shaft, Soft Pile Covered Dbl Ball.....	<b>87.15B ea.</b>
<b>LL326</b>	Gong Mallet, Soft Pile.....	<b>88.70B ea.</b>
<b>LL2320</b>	Acrolite Shaft, Black Pile Covered Dbl Ball.....	<b>85.05B ea.</b>

## ALUMINUM SHAFT MARCHING MALLETS-MULTI TOM

<b>LL5300</b>	Delrin Disc.....	<b>\$42.00B pr.</b>
<b>LL5301</b>	Delrin Cartwheel.....	<b>42.00B pr.</b>
<b>LL5302</b>	Hard Felt.....	<b>45.15B pr.</b>

## ALUMINUM SHAFT MARCHING MALLETS-BRASS DRUM

<b>LL5310</b>	Small Hard Felt.....	<b>\$51.45B pr.</b>
<b>LL5311</b>	Medium-Hard Felt.....	<b>56.70B pr.</b>
<b>LL5312</b>	Large Hard Felt.....	<b>68.25B pr.</b>
<b>LL5313</b>	X-Large Hard Felt.....	<b>72.45B pr.</b>

## ACROLITE MARCHING MALLETS

<b>LL2323</b>	Bass Drum Mallet w/Strap.....	<b>\$52.50B ea.</b>
<b>LL2331</b>	Bass Drum Mallet w/Thong.....	<b>73.50B pr.</b>
<b>LL2333</b>	Tenor Drum Mallet w/Thong.....	<b>65.10B pr.</b>

## MUSSER KEYBOARD MALLETS-RATTAN HANDLE

<b>LM204</b>	Yarn, Very Soft, 1 3/8", Natural.....	<b>\$65.10B pr.</b>
<b>LM207</b>	Yarn, Medium, 1", Blue.....	<b>57.00B pr.</b>
<b>LM208</b>	Yarn, Medium-Soft, 1", Yellow.....	<b>58.30B pr.</b>
<b>LM212</b>	Rubber, Medium, 1", Red.....	<b>36.75B pr.</b>
<b>LM213</b>	Rubber, Medium-Hard, 1", Blue.....	<b>37.80B pr.</b>
<b>LM216</b>	Cord, Hard, 1", Red.....	<b>68.25B pr.</b>
<b>LM220</b>	Yarn, Soft, 1 1/8", Black (Set of 4).....	<b>197.40B set</b>
<b>LM221</b>	Yarn, Medium-Hard, 1 1/8", Gold (Set of 4).....	<b>197.40B set</b>

## MUSSER KEYBOARD MALLETS-GOOD VIBES

<b>LM225</b>	Poly, Medium-Hard, 1", White.....	<b>\$45.15B pr.</b>
<b>LM226</b>	Poly, Medium-Hard, 1 1/8", White.....	<b>45.15B pr.</b>
<b>LM227</b>	Nylon, Hard, 1", White.....	<b>40.95B pr.</b>
<b>LM228</b>	Yarn, Medium-Soft, 1 3/8", Navy (Set of 4).....	<b>247.80B set</b>
<b>LM229</b>	Yarn, Medium-Hard, 1 3/8", Yellow (Set of 4).....	<b>224.70B set</b>
<b>LM235</b>	Yarn, Medium-Hard, 1 3/8", Royal Blue (Set of 4).....	<b>211.05B set</b>
<b>LM237</b>	Yarn, Medium-Hard, 1 7/16", Violet (Set of 4).....	<b>211.05B set</b>
<b>LM239</b>	Yarn, Medium-Hard, 1 1/2", Green (Set of 4).....	<b>211.05B set</b>

## MUSSER KEYBOARD MALLETS-MISCELLANEOUS MALLETS

<b>LM336</b>	Rawhide Chime Mallet.....	<b>\$40.95B</b>
<b>LM337</b>	Dual Head Chime Mallet.....	<b>90.30B</b>
<b>LM347</b>	Handle for M337.....	<b>45.70B</b>
<b>LM348</b>	Yellow Head for M337.....	<b>38.85B</b>
<b>LM349</b>	Green Head for M337.....	<b>32.05B</b>
<b>LM640</b>	Bell Lyra Mallets.....	<b>13.65B pr.</b>
<b>LM643</b>	Jr Percussion Kit Mallets Double Ended.....	<b>26.25B pr.</b>

# GROVER PRO PERCUSSION



## Bass Drum Mallets

- General Bass Drum Mallet  
**BDM1 Maple shaft.....\$40.00B ea.**
- Staccato Bass Drum Mallet  
**BDM2 Maple shaft.....40.00B ea.**
- Ultra Staccato Bass Drum Mallet  
**BDM3 Maple shaft.....40.00B ea.**
- General Bamboo Bass Drum Mallet  
**BDM1B Bamboo shaft ..\$48.00B ea.**
- Staccato Bamboo Bass Drum Mallet  
**BDM2B Bamboo shaft.....48.00B ea.**
- Ultra Staccato Bamboo Bass Drum Mallet  
**BDM3B Bamboo shaft.....48.00B ea.**

## Xylophone/Bell/Marimba Mallets

### Birch Shafts

- GM210** Xylophone Mallets, Rubber, Soft.....**\$28.00 pr.**
- GM212** Xylophone Mallets, Rubber, Med.....**28.00 pr.**
- GM214** Xylophone Mallets, Rubber, Hard.....**28.00 pr.**
- GM220** Bell Mallets, Soft, Cord.....**36.00 pr.**
- GM222** Bell Mallets, Med., Cord.....**36.00 pr.**
- GM224** Bell Mallets, Hard, Cord.....**36.00 pr.**
- GM240** Marimba Mallets, Soft, Yarn.....**36.00 pr.**
- GM242** Marimba Mallets, Med, Yarn.....**36.00 pr.**
- GM244** Marimba Mallets, Hard, Yarn.....**36.00 pr.**
- GMM202** Hard, Delrin Mallets.....**34.00 pr.**



## Keyboard Mallets

Each model features high quality rattan handles.

- GM1** Xylo/Glock Mallet.....**\$40.00B pr.**  
 14" Handle, 1 Hard PVC Ball
- GM2** Xylo/Glock Mallet.....**40.00B pr.**  
 14" Handle, 1 1/8" Hard PVC Ball
- GM3** Xylo/Glock Mallet.....**40.00B pr.**  
 14" Handle, 1" Medium Poly Ball
- GM4** Xylo/Glock Mallet.....**40.00B pr.**  
 14" Handle, 1 1/8" Medium Poly Ball
- GM5** Solo Glock Mallet.....**40.00B pr.**  
 13" Handle, 3/8" Aluminum Oval
- GM6** Solo Glock Mallet.....**40.00B pr.**  
 13" Handle, 3/8" Brass Round
- GM7** Solo Glock Mallet.....**40.00B pr.**  
 13" Handle, 7/8" Hard Phenolic Black
- GM8** Solo Glock Mallet.....**40.00B pr.**  
 13" Handle, 1" Hard Phenolic Black
- GM9** Solo Glock Mallet.....**40.00B pr.**  
 13" Handle, 1 1/8" Hard Phenolic Black
- GM11** "Fat Head" Solo.....**40.00B pr.**  
 14" Handle, Hard Rubber Oval Head
- GM12** "Fat Head" Solo.....**40.00B pr.**  
 14" Handle, Medium Rubber Oval Head
- GM13** "Fat Head" Solo.....**40.00B pr.**  
 14" Handle, Soft Rubber Oval Head



## Timpani Mallets

- General Bamboo Timpani Mallet  
**TMB1 Bamboo shaft.....\$84.00B pr.**
- Hard General Bamboo Timpani Mallet  
**TMB2 Bamboo shaft.....84.00B pr.**
- Ultra Staccato Bamboo Timpani Mallet  
**TMB3 Bamboo shaft.....84.00B pr.**
- Cartwheel Bamboo Timpani Mallet  
**TMB4 Bamboo shaft.....84.00B pr.**
- Staccato Bamboo Timpani Mallet  
**TMB5 Bamboo shaft.....84.00B pr.**
- John Tofoya** General Bamboo Timpani Mallet  
**TMBT1 Bamboo shaft.....90.00B pr.**
- John Tofoya** Bamboo Articulate General Timpani Mallets  
**TMBT2 Bamboo shaft.....90.00B pr.**
- John Tofoya** Bamboo Articulate General Timpani Mallets  
**TMBT2 Bamboo shaft.....90.00B pr.**
- John Tofoya** Bamboo Ultra Staccato Timpani Mallets  
**TMBT3 Bamboo shaft.....\$90.00B pr.**
- John Tofoya** Bamboo Soft Timpani Mallets  
**TMBT4 Bamboo shaft.....90.00B pr.**
- John Tofoya** Bamboo Staccato Timpani Mallets  
**TMBT5 Bamboo shaft.....90.00B pr.**
- General Timpani Mallet  
**GTM1 Maple shaft.....66.00B pr.**
- Staccato Timpani Mallet  
**GTM2 Maple shaft.....66.00B pr.**
- Ultra Staccato Timpani Mallet  
**GTM3 Maple shaft.....66.00B pr.**
- Cartwheel Timpani Mallet  
**GTM4 Maple shaft.....66.00B pr.**
- Hard General Timpani Mallet  
**GTM5 Maple shaft.....66.00B pr.**
- Wood Timpani Mallet  
**GTM6 Maple shaft.....32.00 pr.**



## Gong Mallets/Chime Mallets

Solid New England Hardwood Handles/Hard Rubber Core

- GTT1** Gong Mallet, Large/Heavy.....**\$70.00B ea.**
- GTT2** Gong Mallet, Medium General.....**68.00B ea.**
- GTT3** Gong Mallet, Hard General.....**66.00B ea.**
- GTT4** Gong Mallet, Medium Soft.....**80.00B ea.**



## Chime Mallets

- PM3** Two-Tone Chime Mallet – 1.5" PVC Head.....**\$40.00B**
- PM4** Two-Tone Chime Mallet – 1.75" PVC Head.....**40.00B**

# VATER PERCUSSION

## SUGAR MAPLE STICKS

VATSM5AW	.....	\$15.29	pr.
VATSM5AN	.....	15.79	pr.
VATSM5BW	.....	15.29	pr.
VATSM5BN	.....	15.79	pr.
VATSM7AW	.....	15.29	pr.
VATSM7AN	.....	15.79	pr.
VATSMPTRW	Phat Ride Wood	15.29	pr.
VATPIANW	Pianissimo	15.29	pr.
VATBN	Blazer Nylon	\$15.79	pr.
VATBW	Blazer Wood	15.29	pr.
VATCW	Concert Wood	15.29	pr.
VATPW	Piccolo Wood	15.29	pr.
VATMMJ2451	Mike Johnson	17.29	pr.

## DRUMSTICK/MALLET

### Sizzle Fusion™ Ultra Staccato

The classic Fusion, with a hard felt mallet head on the end.

VATVSZLF	.....	\$35.99	pr.
VATVSZLFA	Acorn	35.99	pr.
VATSS	Staccato Mallet,		
	Sizzle Stick	35.99	pr.

## XTREME DESIGN STICKS

VATXD5AW	Wood	\$15.29	pr.
VATXD5AN	Nylon	15.79	pr.
VATXD5BW	Wood	15.29	pr.
VATXD5BN	Nylon	15.79	pr.
VATXDRW	Wood	15.29	pr.
VATXDRN	Nylon	15.79	pr.
VATXDWW	Warrior Wood	15.29	pr.
VATXDPW	Punisher Wood	15.29	pr.
VATXDDW	Destroyer Wood	15.29	pr.

## CYMBAL STICKS

VATB	Hard Rock Maplewood,		
	Ball Tip	\$15.29	pr.
VATA	Hard Rock Maplewood,		
	Acorn Tip	15.29	pr.
VATCTW	Hard Rock Maplewood,		
	Teardrop Tip	15.29	pr.

## VATER BEBOP SERIES

The BeBop series are smaller grip sized models that are perfect for lower volume or Jazz settings. The 500 and 525 models come in under a 7A in the grip. The quick taper produces a fast rebound with a small tip size for a clean ride cymbal tone.

VATVHBB500	.....	\$15.29	pr.
VATVHBB525	.....	15.29	pr.
VATVHBB550	.....	15.29	pr.

## POWER STICKS

VATP3AW	Wood Tip	\$15.29	pr.
VATP5AW	Wood Tip	15.29	pr.
VATP5BW	Wood Tip	15.29	pr.
VATP5AN	Nylon Tip	15.79	pr.
VATP5BN	Nylon Tip	15.79	pr.

## GOODWOOD STICKS

GW7AW	Wood Tip	\$6.29	pr.
GW5BW	Wood Tip	6.29	pr.
GW5AW	Wood Tip	6.29	pr.
GW2BW	Wood Tip	6.29	pr.
GWROCKW	Wood Tip	6.29	pr.
GW7AN	Nylon Tip	6.59	pr.
GW5BN	Nylon Tip	6.59	pr.
GW5AN	Nylon Tip	6.59	pr.
GW2BN	Nylon Tip	6.59	pr.
GWROCKN	Nylon Tip	6.59	pr.

## SIGNATURE SERIES

VATKARLW	Karl's Drumbale	\$17.29	pr.
VATCHADW	Chad Smith	17.29	pr.
VATSEXTON	Chad Sexton	17.29	pr.
VATCBW	Craig Blundell	17.29	pr.
VATPB5C1	Stephen Creighton		
	(Pipe Band)	17.29	pr.
VATBGW	Ben Gilles	17.29	pr.
VATMRAF	Morgan Rose	17.29	pr.
VATDSK	DSK Wood	15.79	pr.
VATRRW	Rikki Rockett	17.29	pr.
VATJOSHW	Josh Frees	17.29	pr.
VATVHJCW	Jimmy Cobb	17.29	pr.
VATSCSTD	Stewart Copeland	17.29	pr.
VATCMW	Chris McHugh	17.29	pr.
VATPENNIW	Chris Pennie	17.29	pr.
VATNISANW	Nisan Stewart	17.29	pr.
VATMCW	Big Mike Clemons	17.29	pr.
VATMJ2451	Mike Johnston	17.29	pr.
VATVD	Virgil Donatis/Assault	17.29	pr.

## MARIMBA/VIBES

VATMVM22	Med., Marimba		
	Birch Handle	\$50.00B	pr.
VATVM1	Soft Cord Marimba		
	Birch Handles	48.75B	pr.
VATVM9	Med/Heavy, Rattan		
	Handle	58.00B	pr.
VATVM8	Hard Vibe/Marimba		
	Rattan Handles	57.00B	pr.

## XYLOPHONE/BELLS

VATMVM40	Med. Hard Xylo,		
	Birch Handle	\$45.00B	pr.
VATMVM44	X-Hard Bells,		
	Birch Handle	44.00B	pr.
VATMVM42	Clear Hard	45.00B	pr.
VATVM11	Hard, Rattan Handle	44.50B	pr.
VATMV8	Marching Sticks	15.80	pr.

## WOOD TIP

VATHITW	Hitmaker Wood	\$15.29	pr.
VAT5AW	Los Angeles Wood	15.29	pr.
VAT3AW	Fat Back Wood	15.29	pr.
VATHBW	Heartbeater	15.29	pr.
VATSWINGW	Swing Wood	15.29	pr.
VATNW	Nightstick Wood	15.29	pr.
VAT52JW	52nd Street Jazz Wood	15.29	pr.
VATHWS	West Side	15.29	pr.
VAT55AA	.....	15.29	pr.
VAT55BB	.....	15.29	pr.
VATROCKW	Rock Wood	15.29	pr.
VATUNI	Universal Wood	15.29	pr.
VATSHW	Shedder Wood	15.29	pr.
VATSE5	Session Wood	15.29	pr.
VATPH	Power House Wood	15.29	pr.
VATJR	Junior Sticks 13" Long	7.49	pr.
VATRECW	Recording, Wood	15.29	pr.
VAT8AW	Wood	15.29	pr.
VATSRW	Sweet Ride, Wood	15.29	pr.
VATSW	Studio One Wood	15.29	pr.
VAT52W	Studio Two Wood	15.29	pr.
VATH	Hammer, Wood	15.29	pr.
VFVHFAW	Fusion Rock Acorn	15.29	pr.
VATFW	Fusion Wood	15.29	pr.
VAT5BW	Wood	15.29	pr.
VAT7AW	Manhattan Wood	15.29	pr.
VAT7AW	Traditional 7A Wood	15.29	pr.
VATPRW	Pro Rock Wood	15.29	pr.
VAT5JW	SuperJazz Wood	15.29	pr.
VATJZRW	Jazz Ride	15.29	pr.
VAT1AW	Wood	15.29	pr.
VAT3SW	Wood	15.29	pr.
VAT2BW	Wood	15.29	pr.
VATNOJW	New Orleans Jazz, Wood	15.29	pr.
VATPTRW	Phat Ride Wood	15.29	pr.
VATGSFW	Gospel Fusion Wood	15.29	pr.
VATGS5BW	Gospel Series	15.29	pr.
VATGS5AW	Gospel Series	15.29	pr.
VAT7AS	7A Wood Stretch Stix	15.29	pr.
VAT5AS	5A Wood Stretch Stix	15.29	pr.

You'll definitely want to add these to your stick bag! The StickMate Tambourine and Shaker models slide right on to your stick, brushes and mallets to give you added sound effects while playing.

VATVSMS	StickMate Shaker	\$37.99
VATVSM	StickMate Tambourine	37.99

## NYLON TIP

VAT2BN	Nylon	\$15.79	pr.
VAT3SN	Nylon	15.79	pr.
VAT1AN	Nylon	15.79	pr.
VAT3AN	Fat Back Nylon	15.79	pr.
VATSWINGN	Swing Nylon	15.79	pr.
VAT5AN	Los Angeles Nylon	15.79	pr.
VAT77AN	Traditional 7A Nylon	15.79	pr.
VAT5BN	Nylon	15.79	pr.
VATROCKN	Rock Nylon	15.79	pr.
VATPRN	Pro Rock Nylon	15.79	pr.
VATNOJN	New Orleans Jazz, Nylon	15.79	pr.
VATFN	Fusion Nylon	15.79	pr.
VATNN	Nightstick Nylon	15.79	pr.

## TIMBALE

VATYJ	Yambu Jazz 1/2"	\$15.29	pr.
VAT38	3/8" Sticks	7.99	pr.
VAT716	7/16" Stix	9.99	pr.
VATSAZON	Gajate Sazon	9.99	pr.

## EXTERNAL BLACK

VATEBDN	Destroyer Nylon	\$15.99
VATEBDW	Destroyer Wood	15.49
VATEBPN	Punisher Nylon	15.99
VATEBPW	Punisher Wood	15.49
VATEBWN	Warrior Nylon	15.99
VATEBWW	Warrior Wood	15.49
VATEB5AN	5AN	15.99
VATEB5AW	5AW	15.49
VATEB5BN	5BN	15.99
VATEB5BW	5BW	15.49
VATEBP5BN	Power 5BN	15.99
VATEBP5BW	Power 5BW	15.49

## PRACTICE PACK

2 Pairs Vater 5A Wood Tip Drumsticks, 1 Vater Stick Bag, 1 6" Vater Chop Builder Practice Pad

VATPP	.....	\$87.70
-------	-------	---------

**ASK ABOUT OUR  
PRINT MUSIC  
DEPARTMENT**

**FAX & E-MAIL ORDERS  
FOR PRINTED MUSIC  
WILL GET AN EXTRA  
5% DISCOUNT**

**FAX:  
(708) 496-2130  
(888) 983-5537**

**E-MAIL:  
sales@harristeller.com**

www.vater.com

## HOT STICKS



Top grade hickory sticks, with a glossy external finish. Available in nylon tip.

**HOT2B HOT5A HOT5B HOT7A HOTROCK**

**\$7.95 pr.**

Available in W (white), BK (black), R (red), B (blue), Y (yellow), PU (purple) G (green), SI (silver), 24K (gold). Specify model number and color, i.e.. HOT7AR = 7A Red Hot Sticks.

## MACROLUS STICKS



**Metallics:** With a look of molten metal.

**Holographics:** With hundreds of combinations of patterns and colors, the holographics provide prismatic and three-dimensional effects.

**Special FX:** This unique category contains an astounding assortment of simulated marbles, granites, burl woods, aged metals, rainbows, and abstract patterns.

**Double FX:** The double FX series is created by forming two distinct pattern/color zones on the same stick.

**Traditional:** The traditional series gives the look and feel of natural hickory with the added benefit of a compressed, densified rim-shot area.

**Sampler:** An assortment of the best selling wood or nylon tip finishes.

Nylon Tip .....**\$12.95 pr.** Wood Tip .....**\$12.75 pr.**  
3S Nylon .....**\$13.95 pr.** 3S Wood .....**\$13.75 pr.**

Available in: 7A, Rock, 5A, 5B, 2B, 3S. **Sold in packs of 12 pairs.**

**MAC#NMET** Nylon Metallic  
**MAC#WMET** Wood Metallic  
**MAC#NHOL** Nylon Holographic  
**MAC#WHOL** Wood Holographic  
**MAC#NSPFX** Nylon Special Effects  
**MAC#WSPFX** Wood Special Effects  
**MAC#NDFX** Nylon Double FX  
**MAC#WDFX** Wood Double FX  
**MAC#NTRAD** Nylon Traditional  
**MAC#WTRAD** Wood Traditional  
**MAC#NSAMP** Nylon Sampler  
**MAC#WSAMP** Wood Sampler  
**MAC#NAF** Nylon American Flag  
**MAC#WAF** Wood American Flag



[www.hotsticksdrumsticks.com](http://www.hotsticksdrumsticks.com)

## AQUARIAN STICKS

### FORMULA X-10

Formula X-10 drumsticks provide the durability drummers have been looking for with no sacrifice in sound or feel.

**X10 Combo; X10 Rock; X10 Combo**.....**\$19.99 pr.**

### X10 LITES

X10 Lites with Graphite are remarkably close to wood in response and weight.

**X10LT** 5A, 5B, 2B.....**\$16.85 pr.**

**X10LTG** 5A, 3A, 5B, 2B, with grips.....**18.95 pr.**

## ECONO STICKS

**WH** Wood Tip 30 Pr/Box Specify 2B, 5A, or 5B.....**\$117.55 bx.**

**DS30A** Wood Tip 10 ea., 5B, 2B, 7A.....**105.85 bx.**

**PERFEKT** Wood Tip 2B, 5A, 5B, 7A, ROCK.....**4.40 pr.**

(Available In: Pnk, Wht, Red, Blk, YelBlk, RedBlk, i.e Red 2B)

## STICKS BY THE POUND

### DRUMSTICKS

**SBPO** Oak Wood Tip Sticks: 2B, 5B, 5A, 7A .....**\$4.00 pr.**  
(i.e. SBPO2BW)

**SBPO** Oak Nylon Tip Sticks: 2B, 5B, 5A, 7A.....**4.35 pr.**  
(i.e. SBPO2BN)

**SBPM** Maple Wood Tip Sticks: 2B, 5B, 5A, 7A .....**3.35 pr.**  
(i.e. SBPM2BW)

**SBPM** Maple Nylon Tip Sticks: 5B, 5A.....**3.70 pr.**  
(i.e. SBPM5BN)

### PERCUSSION MALLETS – BUNDLED RODS – BRUSHES

**STPM1** Percussion Mallets .....**\$15.75**

**STPSSR** Spaghetti Sticks with RubberGrip Handle .....**15.75**

**STPSSW** Spaghetti Sticks with Wooden Handle .....**15.75**

**STPW1** Wire Brushes Retractable, Rubber Handle.....**20.50**

## FIRESTIX



Translucent sticks, light up when played. Dazzling blue or red color.

**FX12BL** Blue .....**\$27.95 pr.**

**FX12RD** Red .....**27.95 pr.**

**FX12GR** Green.....**27.95 pr.**

**FX12PR** Purple.....**27.95 pr.**

**FX12OR** Orange .....**27.95 pr.**

**FXRB** Replacement Battery.....**6.00/6 pk.**

## DURATECH STICKS



Duratech Sticks are offered in unique also dazzling finishes. Made of nylon they are designed for durability, yet have the rigidity of wood. Available in: 2B, 5A, 5B, and Rock. Specify Model Number and color. i.e.: DT5ABK = Duratech 5A Black.

**DESIGNER SERIES** .....**\$17.10 pr.** **SOLID COLOR**.....**\$17.00 pr.**

**DTRW** Red with White Stripes

**DTR** Red

**DTBW** Blue with White Stripes

**DTBK** Black

**DTPUW** Purple with White Stripes

**DTB** Blue

**DTPIW** Pink with White Stripes

**DTPU** Purple

**DTBKW** Black with White Stripes

**DTPI** Hot Pink

**DTBKR** Black with Red Stripes

**DTY** Yellow

**DTBKY** Black with Yellow Stripes

**DTW** White

**DTBKB** Black with Blue Stripes

**DTBKPI** Black with Pink Stripes

**DTPUPI** Purple with Pink Stripes

**DTBPI** Blue with Pink Stripes

**DTYR** Red with Yellow Stripes

## VERI-SONIC DRUM STICKS

### ALUMINUM

**VS40** 14" Light Orchestra, 2 1/4 oz., 1/2" diameter .....**\$17.95**

**VS41** 14 1/2" Orchestra, 2 1/2 oz., 1/2" diameter .....**17.95**

**VS42** 16" Dance band, 2 1/4 oz., 7/16" diameter .....**17.95**

**VS43** 15 1/2", Pencil, 1 3/4 oz., 3/8" diameter .....**17.95**

**VS44** 15 1/2" Parade, 3 1/4 oz. ....**17.95**

Available in Bk (black), DB (dark blue), LB (lt. blue) & R (red).

# BRUSHES

## VERI SONIC



VS10	Rubber handle, loop end.....	\$19.50 pr.
VS20	Rubber handle, ball end.....	20.50 pr.
VS60	Rubber handle, flip out.....	18.50 pr.
VS15	Plain handle loop end.....	18.50 pr.
VS25	Plain handle ball end.....	19.75 pr.
VS65	Plain handle, flip out.....	18.25 pr.
VS30BK	Anodized handle, loop end, Black.....	\$19.75 pr.
VS35BK	Anodized handle, ball end, Black.....	20.25 pr.
VS70BK	Anodized handle, flip out, Black.....	18.75 pr.



## CANNON/SILVER FOX

UPBR5	Rubber handle, loop end.....	\$31.50 pr.
SWISKAS	Rubber Handle, Retractable.....	35.00B pr.



## LUDWIG

LL190	Red Ribbed Handle w/Loop-End.....	\$42.00B pr.
LL191	Red Grooved Handle.....	34.65B pr.
LL194	Red Grooved Handle/Ball End.....	35.70B pr.
LL195	White Plastic Handle.....	37.80B pr.



## ZILDJIAN

DWBZB1	Rubber Handle, Telescoping.....	\$34.00 pr.
DWBF	Rubber Handle, Non-Telescoping.....	34.00 pr.
SDWB3	Bent Bristle.....	39.95 pr.
SDM1	Mezzo 1, Multi Rod.....	28.50 pr.
SDM2	Mezzo 2, Multi Rod.....	28.50 pr.



## INNOVATIVE

IPBR1	Retractable Nylon Brushes – Light.....	\$27.00 pr.
IPBR2	Retractable Nylon Brushes – Medium.....	27.00 pr.
IPBR3	Wood Handle Nylon Brushes – Medium.....	29.00 pr.
IPBR4	Wood Handle Nylon Brushes – Heavy.....	29.00 pr.
IPBR5	Synthetic Bundle Rods – Light.....	27.00 pr.
IPBR5W	Synthetic Bundle Rods – Light/Wood Handle.....	27.00 pr.
IPBR8	Fanned “Caps” Bundle Stick.....	62.00 pr.
IPBR9	Fanned Bundle Stick.....	52.00 pr.
WBR1	Wire Retractable w/Pull Rod – Medium.....	37.00 pr.
WBR2	Wire Retractable w/Pull Rod – Heavy.....	37.00 pr.
WBR1X	Wire Retractable w/Pull Rod 7.5”, Medium.....	37.00 pr.
WBR2X	Wire Retractable w/Pull Rod 7.5”, Heavy.....	37.00 pr.
WBR3	Wire Brush, Medium Fixed Wood Handle.....	34.00 pr.
IPHBB	“Flipz” – Hybrid Bundle Stick.....	33.00 pr.
IPHJZ	“Jamz” – Synthetic Bundle Stick – Heavy.....	43.00 pr.
IPHSZ	Sweepz.....	33.00 pr.
BMZ1	Slim Broomz – for lighter playing.....	32.00
BMZ2	Phat Broomz – larger and is able to create a solid backbeat, can be used on Cajon.....	33.00

## PRO MARK



## REGAL TIP



## VIC FIRTH



## VATER



## TELESCOPIC

Ribbed rubber handle, rattle free.

TB3	Light.....	\$42.00 pr.
TB4	Heavy.....	46.50 pr.
TB5	EZ Grip Handle.....	45.00 pr.
TB6	EZ Grip Handle, Heavy.....	45.00 pr.
B300	Wood Handle, Wire.....	44.00 pr.
PMBRM	Broomstick.....	37.00 pr.
PMBRM2	Broomstick, Small.....	37.00 pr.

## NYLOBRUSHES

B600	Nylon.....	\$37.00 pr.
B400	Blue Nylon.....	37.00 pr.

## MULTI RODS

RODS	Original.....	\$33.00 pr.
CRODS	Cool, Light.....	32.00 pr.
LRODS	Lightning, Med.....	33.00 pr.
TRODS	Thunder, Hvy.....	32.00 pr.

582RJR	Jr. Robinson.....	\$43.00 pr.
550W	Hickory Handle (Y).....	31.00 pr.
561A	Alum. Telescoping (B).....	36.00 pr.
583R	Telescoping Soft Handle.....	42.00 pr.
590R	Jason Sutter, Telescoping Wire.....	43.00 pr.
594P	Nylon, Ed Thigpen.....	33.00 pr.
565U	Nylon, Ultra Flex.....	33.00 pr.
565FC	Nylon, Fat Cat.....	36.00 pr.
595N	Whisker.....	36.00 pr.
593C	Clayton Cameron.....	46.00 pr.
532R	Flares.....	33.00 pr.
596R	Jeff Hamilton.....	43.00 pr.
551WXL	Large Hickory Handle.....	33.00 pr.
500PLB	Rubber Handle.....	28.00 pr.
584W	Ed Thigpen, Wood Butt.....	51.00 pr.
505YJ	Throw.....	30.00 pr.
575YJ	Retractable.....	31.00 pr.
542L	Conga Sticks.....	57.00 pr.

## BLASTICKS

Thermo plastic brushes.

530R	Plastic Handle.....	\$33.00 pr.
531R	Hickory Handle.....	35.00 pr.
521RBJ	Blackjack.....	36.00 pr.
522P	Swish Cajon.....	39.00 pr.
523P	Wave Cajon.....	39.00 pr.
BR519P	Cajon.....	35.00 pr.

## VFRUTES

VFRUTE	16 Dowels.....	\$33.60 pr.
VFRUTE202	8 Dowels.....	33.60 pr.
VFRUTE303	7 Dowels.....	33.60 pr.
VFRUTE505	31 Bristles.....	33.60 pr.
VFRUTE606	Rubber Handle.....	33.60 pr.
VFTW11	Bamboo Talawand.....	38.85 pr.
VFTW12	Birch Talawand.....	38.85 pr.

VFJRAKE	Jazz, Nylon.....	\$38.85 pr.
VFRRAKE	Rock, Nylon.....	38.85 pr.
VFWB	Jazz Brushes.....	37.80 pr.
VFLB	Legacy, Push-Pull.....	54.60 pr.
VFDLKS	Dreadlocks.....	43.60 pr.
VFHB	Heritage.....	37.80 pr.
VFSGWB	Steve Gadd.....	40.15 pr.
VFLW	Live Wires.....	46.75 pr.

VATPB	Poly Brush, Retractable.....	\$33.00 pr.
VATAC	Acoustick.....	37.49 pr.
VATWTHW	Heavy Wire, Retractable.....	39.00 pr.
VATBSW	Telescoping.....	29.00 pr.
VATWTR	Rubber Handle, Loop End.....	37.99 pr.
VATWTW	Wood Handle.....	33.00 pr.
VATWTSB	Stick/Brush.....	31.50 pr.
VATWS	Whip Stick.....	31.99 pr.
VATSPLASH	Splash Sticks.....	32.99 pr.
VATSPSL	Splash Sticks, Lite.....	32.99 pr.
VATWHWP	Wood Handle Whip.....	32.99 pr.
VATVBM	Monster.....	34.99 pr.
VATVCS	Cajon.....	38.00 pr.
VATVSPST	Splash Sticks/Traditional.....	30.49 pr.
VATVPSB	Splash Stick/Bamboo.....	32.99 pr.
VATVSPSRK	Splash Stick Rock.....	32.99 pr.
VATACS	Acoustick Solid/Cross Cut.....	37.49 pr.
VATVWB	Wood Hndl/Whip Brush.....	33.00 pr.

## BOOMWHACKERS



### BOOMPHONE XTS WHACK PACK

Includes: 8-tube Boomwhackers C Major Diatonic Set, XyloTote™ Tube Holder, Boomwhacker Whacker™ Mallets, the Whack-a-Doodle-Do! Songbook, and Octavator™ Tube Cap and Instructions.

**BPXS** .....\$58.98



### C MAJOR DIATONIC SCALE

Consists of 8 notes: C-D-E-F-G-A-B-C. The diatonic scale allows more songs to be played and is preferred over the pentatonic scale.

**BWDG** .....\$25.98



### C MAJOR PENTATONIC SCALE

Consists of 6 notes: C-D-E-G-A-C.

**BWPG** .....\$20.98



### CHROMATICS SET

Set consists of the five sharps/flats for our standard octave.

**BWCG** .....\$17.98

**BWEG Treble Extension Set** .....\$16.98  
7-Tube Set starts where the C Major Diatonic Set leaves off and contains high C#, D#, D#, E#, F#, F#, and G#.

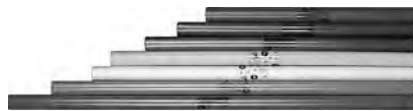

### C MAJOR BASS DIATONIC

Consists of 7 notes: C-D-E-F-G-A-B.

**BWJG** .....\$46.98

**OC8G Octavator™ Tube Caps 8 Pack** .....\$9.98  
The Caps lower the tone of the Tubes by an octave.

**WKRI Boomwhacker Whacker™ Mallets** .....7.98 pr.

**WBCI Whack A Boom Cards** .....12.98



### BASS CHROMATICS SET

Consists of the 5 sharps/flats for our bass octave.

**BWKG** .....\$34.98

**XT08 XyloTote™ Tube Holder** .....\$25.15  
A whole new way to play your Boomwhackers Tuned Percussion Tubes – like a xylophone!

## STICK RAP



### PRO MARK

Reusable wrap-on cushioned sticktape available in GRE (green), YEL (yellow), BLA (black), BLU (blue), CR (red, black), CW (white, black), PUR (purple), WHI (white), RED (red).

**SR** .....\$11.50

**SR3 Tricolor – BLA (Black/White/Red) WHI (White/Black/Red)** .....13.50

**ATWHI 1" x 108" Roll** .....12.50

**MWBLA Black Mallet Wrap** .....11.50

### GROOVE JUICE

**GJSG** .....\$15.45

## BALTER BAGS



Padded nylon, zippered carry all bag. Room for mallets, sticks, music, accessories, and more.

**MBMBMC Carry All** .....\$85.00

**MBMBMP Mallet Pouch** .....15.00

**MBMBMB Mallet Bag** .....50.00

## GORILLA GRIPS



Reusable rubber sleeve stick grips.

**DBGGM Fits 2B, 5B, Rock** ..\$7.49 pr.

## STICK TAPE

### VATER STICK TAPE

Each roll is 1 inch wide by 30 feet in length. One roll will wrap approximately 5 pairs of sticks.

R (Red), W (White), B (Blue), G (Green), BK (Black)

**VATST** .....\$9.50

### VATER GRIP TAPE

Each package contains 4 rolls, which is enough to wrap at least 2 pairs of sticks depending on the stick length/diameter and how much you overlap the tape while wrapping. Each roll contains 2 end tapes for extra security on the stick and is reusable. R (Red), B (Black), W (White), G (Gray)

**VATGT** .....\$12.95/4 pk.

### ZWAX

Zildjian Stick Wax, 2oz

**ZWAX** .....\$8.95



### VIC FIRTH TAPE

**VICTAPE** .....\$8.50B

### DRUMSTICK GRIP TAPE

1 1/2" x 30 ft. roll. Available in: BK (Black), W (White), B (Blue)

**SH** .....\$5.95

## STICK RACK



### STRING SWING

9 compartment drum stick rack for 216 pairs of sticks.

**DSR** .....\$149.97

# STICK CADDIES

## INNOVATIVE



- IPSB1 Marching Stick Bag/1 pair.....\$15.00B
- IPSB2 Marching Stick Bag/2 pair.....20.00B
- IPSB3 Fundamental Stick Bag.....25.00B
- IPMB1 Mallet Tour Bag/Small/Cordura.....60.00B
- IPMB3 Mallet Tour Bag/Large/Cordura.....85.00B

Synthetic leather stickbag features 6 interior pockets that can accommodate numerous pairs of drumsticks, brushes, Bundlz, and other accessories.  
**IPDSB2** .....\$70.00B

## PRO MARK



- PB20 Large Pad Bag.....\$99.95
- DSB1 Canvas.....45.00
- DSB4 Nylon.....24.00
- JSB5 Jumbo, Nylon.....55.00
- JSB6 Jumbo, Deluxe.....70.00B
- JMB2 Jumbo Mallet.....109.00B
- HMB1 Hanging Mallet.....84.00B
- JJBAG Joey Jordison.....47.95

## VATER



- PINK STICK BAG**  
 Features an all-over style print. Features 2 large outside pockets, with multiple pockets and pouches inside for tons of accessory storage space. Stick storage space is divided into 2 large section and includes Velcro straps for hanging on floor toms.  
**VATBPINK** .....\$47.99

## CANNON



Features heavy black nylon weave, velcro seal pocket and s-hooks to hang from any drum set.  
**UPNSB4** .....\$25.75

## ZILDJIAN



- Z3255.....\$19.95
- Z3256 Super.....34.85
- ZTRAV2 Travis Barker.....44.95
- ZTCB Cindy Blackman.....44.95
- PSSB Leather Like.....59.95
- TRESB2 Tre Cool.....44.95

## STICK BAGS



- CD050 Nylon.....\$14.60
- B4680 TKL Black, Nylon.....22.55
- B4780 TKL Black, Cordura.....33.95
- BSC1 Nylon.....18.20
- 4013 Nylon.....20.00
- STC6N Regal Tip.....28.00
- 380C Regal Tip, Fundamental.....21.00

## LP



**LP537BK Pro Model**.....\$72.00

## PRO MARK

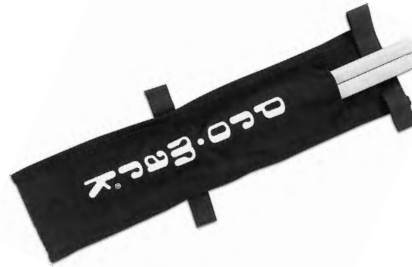

- PMQ1 1 pr. Quiver.....\$25.00B
- PMQ3 3 pr. Quiver.....32.00B

## VIC FIRTH



- VFBSB Stick, Canvas.....\$29.40B
  - VFMSBAG March (1 pr.).....13.40B
  - VFMSBAG2 March (2 pr.).....25.75B
  - VFKBAG Mallets.....85.05B
  - VFSBAG2 Leather Like (24).....78.00B
  - VFESB Essentials Stick Bag (4-5 pr.).....22.05B
  - VFVP VicPack.....122.85B
- A backpack with a detachable stick bag!  
 The stick bag holds 12 pairs of sticks.

## AQUARIAN



- AQDB3 .....\$35.00
- AQSQ10 W/pad & pr. Sticks.....\$70.00

## MOUNTABLE TUBE STICK HOLDERS



- SD100 Holds 1 pr./Pro Mark.....\$19.00B
- SD200 Holds 2 pr./Pro Mark.....21.00B
- SD400 Pro Mark.....23.00B
- DAN1027 Holds 3 pr./Danmar.....46.95
- VATVSHM Multi/Vater.....27.99
- VATVSHS Single/Vater.....25.99
- VFCADDY 2-3 pair/Vic Firth.....36.75
- SS4000 4 pr./Swirlshtick L/S BK.....19.99
- SS7000 4 pr./Swirlshtick R/S BK.....19.99
- DAI00 On/Stage, Multi Holder.....29.99

## VATER



- A tough nylon bag that will keep you well stocked and organized. Includes Velcro strips for secure placement on drums and an adjustable shoulder carrying strap.  
**VATVSB1 Stick Bag** .....\$47.95
- Sturdy nylon bag with 4 large pockets for storing many pairs of mallets. The tapered bag design helps prevent mallet heads from bunching together. Includes zipper pocket inside and a large pocket on the outside for storing sheet music.  
**VATVMMB Mallet Bag** .....\$54.95



# REMO

## DIPLOMAT

BATTER	COATED	CLEAR
6"	BD0106	BD0306
8"	BD0108	BD0308
10"	BD0110	BD0310
11"		
12"	BD0112	BD0312
13"	BD0113	BD0313
14"	BD0114	BD0314
15"	BD0115	BD0315
16"	BD 0116	BD0316
18"	BD0118	BD0318
20"		

## AMBASSADOR

COATED	SMOOTH WHITE	CLEAR
BA0106	BA0206	BA0306
BA0108	BA0208	BA0308
BA0110	BA0210	BA0310
BA0111	BA0211	BA0311
BA0112	BA0212	BA0312
BA0113	BA0213	BA0313
BA0114	BA0214	BA0314
BA0115	BA0215	BA0315
BA0116	BA0216	BA0316
BA0118	BA0218	BA0318
BA0120	BA0220	BA0320

## EMPEROR

COATED	SMOOTH WHITE	CLEAR	PRICE
BE0106	BE0206	BE0306	\$23.80
BE0108	BE0208	BE0308	24.60
BE0110	BE0210	BE0310	25.90
BE0111	BE0211	BE0311	26.70
BE0112	BE0212	BE0312	27.70
BE0113	BE0213	BE0313	28.40
BE0114	BE0214	BE0314	31.00
BE0115	BE0215	BE0315	32.50
BE0116	BE0216	BE0316	34.10
BE0118	BE0218	BE0318	42.80
BE0120	BE0220		47.20

## BASS

16"		BR1216		BB1216			\$60.50	
18"		BR1118	BR1218	BR1318	BB1118	BB1218	BB1318	63.00
20"		BR1120	BR1220	BR1320	BB1120	BB1220	BB1320	65.60
22"		BR1122	BR1222	BR1322	BB1122	BB1222	BB1322	69.70
24"		BR1124	BR1224	BR1324	BB1124	BB1224	BB1324	74.30
26"		BR1126	BR1226	BR1326	BB1126	BB1226	BB1326	84.30
28"		BR1128	BR1228	BR1328	BB1128	BB1228	BB1328	91.50
30"		BR1130	BR1230	BR1330				97.90
32"		BR1132	BR1232	BR1332				106.10
34"		BR1134	BR1234					118.40
36"		BR1136	BR1236	BR1336				128.60
40"			BR1240					138.60



## SILENTSTROKE™ LOW VOLUME PRACTICE

Batter		
SN0006	Batter, 6"	\$23.80
SN0008	Batter, 8"	24.60
SN0010	Batter, 10"	25.90
SN0012	Batter, 12"	27.70
SN0013	Batter, 13"	28.40
SN0014	Batter, 14"	31.00
SN0015	Batter, 15"	32.50
SN0016	Batter, 16"	34.10
SN0018	Batter, 18"	42.80

Bass		
SN1018	Bass, 18"	\$63.00
SN1020	Bass, 20"	65.60
SN1022	Bass, 22"	69.70
SN1024	Bass, 24"	74.30

## AMBASSADOR X

AX0108	Batter, Coated, 8"	\$24.60
AX0110	Batter, Coated, 10"	25.90
AX0112	Batter, Coated, 12"	27.70
AX0113	Batter, Coated, 13"	28.40
AX0114	Batter, Coated, 14"	31.00
AX0115	Batter, Coated, 15"	32.50
AX0116	Batter, Coated, 16"	34.10

## AMBASSADOR X14

X14 is constructed with a coated single-ply of 14-mil Mylar®

AX011314	Batter, Ambassador x14, Coated, 13"	\$28.40
AX011414	Batter, Ambassador x14, Coated, 14"	31.00

## REMO® PROPACKS

PP0112BA	Propack (12", 13", 16" Ba-coated Free BaO11400	\$90.20/pk
PP0110PS	Propack (10", 12", 14" Ps-coated, Free BaO11400	93.20/pk
PP0320PS	Propack (12", 13", 16" Clear Ps, Free BaO11400	101.20/pk
PP0240BE	Propack (10", 12", 14" Clear Be, Free BaO11400	84.60/pk
PP0250BE	Propack (12", 13", 16" Clear Be, Free BaO11400	90.20/pk

## EMPEROR X™

Xtreme durability		
BX011010	Batter, Black Dot Bottom, 10"	\$29.50
BX011210	Batter, Black Dot Bottom, 12"	32.50
BX011310	Batter, Black Dot Bottom, 13"	35.60
BX011410	Batter, Black Dot Bottom, 14"	39.00

## VINTAGE AMBASSADOR

VA0110	Batter, Coated, 10"	\$27.90
VA0112	Batter, Coated, 12"	29.50
VA0113	Batter, Coated, 13"	31.00
VA0114	Batter, Coated, 14"	33.10
VA0116	Batter, Coated, 16"	35.60

## VINTAGE EMPEROR

VE0108	Batter, Coated, 8"	\$26.40
VE0308	Batter, Clear, 8"	26.40
VE0110	Batter, Coated, 10"	27.90
VE0310	Batter, Clear, 10"	27.90
VE0112	Batter, Coated, 12"	29.50
VE0312	Batter, Clear, 12"	29.50
VE0113	Batter, Coated, 13"	31.00
VE0313	Batter, Clear, 13"	31.00
VE0114	Batter, Coated, 14"	33.10
VE0314	Batter, Clear, 14"	33.10
VE0115	Batter, Coated, 15"	35.10
VE0315	Batter, Clear, 15"	35.10
VE0116	Batter, Coated, 16"	35.60
VE0316	Batter, Clear, 16"	35.60
VE0118	Batter, Coated, 18"	40.20
VE0318	Batter, Clear, 18"	40.20

# REMO

## PINSTRIPED

BATTER	CLEAR	PRICE	COATED	PRICE
6"	PS0306	<b>\$26.10</b>	PS0106	
8"	PS0308	<b>26.70</b>	PS0108	<b>\$28.20</b>
10"	PS0310	<b>27.90</b>	PS0110	<b>29.50</b>
11"	PS0311	<b>29.20</b>		
12"	PS0312	<b>31.50</b>	PS0112	<b>31.80</b>
13"	PS0313	<b>32.30</b>	PS0113	<b>33.10</b>
14"	PS0314	<b>33.80</b>	PS0114	<b>34.30</b>
15"	PS0315	<b>35.40</b>		
16"	PS0316	<b>37.40</b>	PS0116	<b>38.70</b>
18"	PS0318	<b>46.60</b>	PS0118	<b>47.20</b>
20"	PS0320	<b>51.00</b>		
<b>BASS</b>				
18"	PS1318	<b>70.25</b>		
20"	PS1320	<b>71.25</b>	PS1120	<b>73.00</b>
22"	PS1322	<b>75.25</b>	PS1122	<b>77.10</b>
24"	PS1324	<b>79.75</b>	PS1124	<b>79.75</b>
26"	PS1326	<b>88.75</b>	PS1126	<b>91.00</b>
28"	PS1328	<b>95.75</b>		
30"	PS1330	<b>103.50</b>		

## FIBERSKYN® 3

BATTER	Diplomat	Ambassador	PRICE
6"	FD0506	FA0506	<b>\$27.90</b>
8"	FD0508	FA0508	<b>28.50</b>
10"	FD0510	FA0510	<b>31.00</b>
11"	FD0511	FA0511	<b>37.90</b>
12"	FD0512	FA0512	<b>34.60</b>
13"	FD0513	FA0513	<b>35.40</b>
14"	FD0514	FA0514	<b>37.20</b>
15"	FD0515	FA0515	<b>39.00</b>
16"	FD0516	FA0516	<b>41.30</b>
18"	FD0518	FA0518	<b>50.00</b>
20"	FD0520	FA0520	<b>56.40</b>
<b>BASS</b>			
18"	FD1518	FA1518	<b>74.30</b>
20"	FD1520	FA1520	<b>76.90</b>
22"	FD1522	FA1522	<b>83.50</b>
24"	FD1524	FA1524	<b>87.40</b>
26"	FD1526	FA1526	<b>103.00</b>
28"	FD1528	FA1528	<b>110.20</b>
30"		FA1530	<b>115.80</b>
32"	FD1532	FA1532	<b>143.50</b>
34"	FD1534	FA1534	<b>153.00</b>
36"	FD1536	FA1536	<b>178.40</b>
40"	FD1540	FA1540	<b>205.30</b>

## Tom-Tom Batter

Size	Clear Black Dot	Price
6"	CS030610	<b>\$25.90</b>
8"	CS030810	<b>26.10</b>
10"	CS031010	<b>27.70</b>
11"	CS031110	<b>28.40</b>
12"	CS031210	<b>31.00</b>
13"	CS031310	<b>32.50</b>
14"	CS031410	<b>34.10</b>
15"	CS031510	<b>35.90</b>
16"	CS031610	<b>38.70</b>
17"	CS031710	<b>51.00</b>
18"	CS031810	<b>48.90</b>

## Snare Batter

Size	Bottom Black Dot Coated	Price
13"	CS011310	<b>32.50</b>
14"	CS011410	<b>34.10</b>

## Bass

Size	Clear Black Dot	Price
18"	CS131810	<b>\$67.70</b>
20"	CS132010	<b>69.70</b>
22"	CS132210	<b>75.60</b>
24"	CS132410	<b>80.00</b>
26"	CS132610	<b>86.90</b>
28"	CS132810	<b>94.60</b>
30"	CS133010	<b>101.00</b>
32"	CS133210	<b>108.70</b>

## EBONY SERIES

BATTER	AMBASSADOR	PINSTRIPED
6"	ES0006	ES0606PS <b>\$35.90</b>
8"	ES0008	ES0608PS <b>37.40</b>
10"	ES0010	ES0610PS <b>38.70</b>
12"	ES0012	ES0612PS <b>40.70</b>
13"	ES0013	ES0613PS <b>41.80</b>
14"	ES0014	ES0614PS <b>44.10</b>
15"	ES0015	ES0615PS <b>45.40</b>
16"	ES0016	ES0616PS <b>48.70</b>
18"	ES0018	ES0618PS <b>56.60</b>
20"	ES0020	ES0620PS <b>62.00</b>
32"	ES1032	
<b>BASS</b>		
16"	ES1016	
18"	ES1018	ES1618PS <b>\$88.20</b>
20"	ES1020	ES1620PS <b>92.50</b>
22"	ES1022	ES1622PS <b>96.60</b>
24"	ES1024	ES1624PS <b>101.70</b>
26"	ES1026	ES1626PS <b>108.10</b>
28"	ES1028	ES1628PS <b>113.80</b>
30"	ES1030	ES1630PS <b>124.50</b>
32"	ES1032	

## EBONY Suede Batter (Black Dot)

ES081310	13"	<b>\$34.60</b>
ES081410	14"	<b>34.00</b>

## EBONY SUEDE SNARE SIDE

SA0813ES	13"	<b>\$33.60</b>
----------	-----	----------------

## EBONY SNARE SIDE

SA0413TD	13"	<b>\$33.60</b>
SA0414TD	14"	<b>34.60</b>

## SPECIALTY BASS DRUM

ES1020CH	20" Ebony with 10" center hole	<b>\$78.00</b>
ES1022CH	22" Ebony with 10" center hole	<b>82.00</b>

## SUEDE/WHITE SUEDE®

BATTER THIN	SUEDE MED	SUEDE HVY	WHITE SUEDE MED	WHITE SUEDE HVY	
6"	BA-0806	BE-0806		<b>\$23.80</b>	
8"	BA-0808	BE-0808	BA-0808WS	BE-0808WS <b>24.60</b>	
10"	BA-0810	BE-0810	BA-0810WS	BE-0810WS <b>25.90</b>	
11"	BA-0811	BE-0811		<b>26.70</b>	
12"	BD-0812	BA-0812	BE-0812	BA-0812WS	BE-0812WS <b>27.70</b>
13"	BD-0813	BA-0813	BE-0813	BA-0813WS	BE-0813WS <b>28.40</b>
14"	BD-0814	BA-0814	BE-0814	BA-0814WS	BE-0814WS <b>31.00</b>
15"	BD-0815	BA-0815	BE-0815		<b>32.50</b>
16"	BD-0816	BA-0816	BE-0816	BA-0816WS	BE-0816WS <b>34.10</b>
18"	BD-0818	BA-0818	BE-0818		<b>42.80</b>
20"	BD-0820	BA-0820	BE-0820		<b>53.50</b>

## BASS

18"	BR1818	BB-1818	<b>\$63.00</b>
20"	BR1820	BB-1820	<b>65.60</b>
22"	BR1822	BB-1822	<b>69.70</b>
24"	BR1824	BB-1824	<b>72.50</b>
26"	BR1826	BB-1826	<b>84.30</b>
28"	BR1828	BB-1828	<b>91.50</b>
30"	BR1830	BB-1830	<b>97.90</b>
32"	BR1832	BB-1832	<b>106.10</b>
34"	BR1834	BB-1834	<b>118.40</b>
36"	BR1836	BB-1836	<b>125.50</b>
40"	BR1840	BB-1840	<b>138.60</b>

# REMO

## POWERSTROKE 3

### Snare Drum Batter

Size	Clear w/Dot	Coated w/Dot	Price
10"		P30110C2	\$29.70
12"		P30112C2	31.50
13"	P30313C2	P30113C2	32.50
14"	P30314C2	P30114C2	34.60

Size	Fiberskyn 3 FD	3 FA	Price
14"	P30514FD	P30514FA	\$35.10

### Tom-Tom Batter

Size	Clear	Coated	Price
6"	P30306BP		\$24.00
8"	P30308BP		26.40
10"	P30310BP	P30110BP	28.40
12"	P30312BP	P30112BP	29.70
13"	P30313BP	P30113BP	31.00
14"	P30314BP	P30114BP	32.50
15"	P30315BP		34.60
16"	P30316BP	P30116BP	38.20
18"	P30318BP		42.50

Bass Size	Clear w/ 2 1/2" White Falam Patch	Coated 2 1/2" White Falam Patch	Clear w/ Black Dot	Price	Fiberskyn 3 FD	Fiberskyn 3 FA	Price	Ebony (front)	Price	Renaissance	Price
18"	P31318C2	P31118C2	P3131810	\$66.00	P31518FD	P31518FA	\$75.60	P31018ES	\$82.00	P31018RA	\$84.80
20"	P31320C2	P31120C2	P3132010	69.40		P31520FA	78.40	P31020ES	86.10	P31020RA	87.60
22"	P31322C2	P31122C2	P3132210	75.60	P31522FD	P31522FA	85.30	P31022ES	90.50	P31022RA	91.50
24"	P31324C2	P31124C2	P3132410	80.50		P31524FA	89.70	P31024ES	95.50		
26"	P31326C2	P31126C2		86.90				P31026ES	106.10		

(20, 22, 24 w/Dynamo)

### Smooth White Front Bass Drumhead

Size	Price
18"	P31218C1 \$66.70
20"	P31220C1 69.40
22"	P31222C1 75.60
24"	P31224C1 80.50
26"	P31226C1 86.90

### Black Suede Bass

Size	Price
18"	P31818ES \$82.00
20"	P31820ES 86.10
22"	P31822ES 90.50
24"	P31824ES 90.75

### Renaissance SNARE DRUM BATTER

Size	Price
13"	P30313RA \$35.60
14"	P30314RA 37.40

### BASS DRUM BATTER

Size	Ambassador	Price
18"	P31018RA	\$84.80
20"	P31020RA	87.60
22"	P31022RA	91.25

## POWERSTROKE II

(without rubber edge)

Diam. Inches	Black Dot	Transparent Dot	Price
13	P20313C1	P20313C2	\$35.90
14	P20314C1	P20314C2	38.20
15	P20315C1	P20315C2	44.10

## POWERSONIC

Controlled mid-range and low-end for the most powerful bass drum sound. Constructed of 2 plies, 7-mil plus 5-mil, of Mylar®, with two specifically placed internal subsonic dampening rings, an external snap-on dampening system and included Falams® Slam for more attack.



COATED	Price	CLEAR	Price
18" PW1118	\$81.00	18" PW1318	\$81.00
20" PW1120	84.80	20" PW1320	84.80
22" PW1122	88.20	22" PW1322	88.20
24" PW1124	93.00	24" PW1324	93.00

## POWERSTROKE PRO

Constructed with 10 mil. film. Features Pressure Dampening Profile. The head uses permanently mounted acoustic foam to deliver maximum volume and projection while producing controlled highs with accentuated mid and maximum low range frequencies.

CLEAR BASS	Price	COATED BASS	Price
18" PR1318	\$81.00	18" PR1118	\$81.00
20" PR1320	84.80	20" PR1120	84.80
22" PR1322	88.20	22" PR1122	88.20
24" PR1324	93.00	24" PR1124	93.00

EBONY® BASS	Price
18" PR1418	\$91.50
20" PR1420	95.20
22" PR1422	98.70
24" PR1424	104.30

## POWERSTROKE 77

13"	P70313C2	\$45.10
14"	P70314C2	46.60
15"	P70315C2	51.80

## POWERSTROKE® X

Coated	Price
13" PX0113BP	\$32.50
14" PX0114BP	34.10

Coated, Clear Dot	Price
13" PX0113C2	34.60
14" PX0114C2	35.60

## POWERSTROKE 4

Size	Coated	Clear	Coated w/dot
8"	P40108BP	P40308BP	\$27.75
10"	P40110BP	P40310BP	29.50
12"	P40112BP	P40312BP	31.50
13"	P40113BP	P40313BP	32.50
14"	P40114BP	P40314BP	34.10
15"		P40315BP	35.60
16"	P40116BP	P40316BP	40.20
18"		P40318BP	45.10

### Bass Drum Batter

Size	Coated w/dot	Price	Clear w/dot	Price
18"	P41118C2	\$72.00	P41318C2	\$72.00
20"	P41120C2	73.30	P41320C2	73.30
22"	P41122C2	80.00	P41322C2	80.00
24"	P41124C2	85.30	P41324C2	85.30

# REMO

## MARCHING DRUMHEADS

### Multi-Tom (Crimplock)

#### Ebony Pinstripe™

6"	PS0406MP	\$29.50
8"	PS0408MP	32.30
10"	PS0410MP	33.60
12"	PS0412MP	35.60
13"	PS0413MP	37.40
14"	PS0414MP	39.00

#### Clear Pinstripe™

6"	PS0306MP	\$29.50
8"	PS0308MP	32.30
10"	PS0310MP	33.60
12"	PS0312MP	35.60
13"	PS0313MP	37.40
14"	PS0314MP	39.00

#### Clear Emperor™

6"	BE0306MP	\$29.50
8"	BE0308MP	32.30
10"	BE0310MP	33.60
12"	BE0312MP	35.60
13"	BE0313MP	37.40
14"	BE0314MP	39.00

#### Smooth White Emperor™

6"	BE0206MP	\$29.50
8"	BE0208MP	32.30
10"	BE0210MP	33.60
12"	BE0212MP	35.60
13"	BE0213MP	37.40
14"	BE0214MP	39.00

#### Ebony Emperor™

6"	BE0006ES	\$27.90
8"	BE0008ES	29.50
10"	BE0010ES	30.50
12"	BE0012ES	33.60
13"	BE0013ES	34.60
14"	BE0014ES	35.60
15"	BE0015ES	38.20
16"	BE0016ES	40.70
18"	BE0018ES	48.90

#### White Suede Emperor™

6"	BE0806MP	\$29.50
8"	BE0808MP	32.30
10"	BE0810MP	33.60
12"	BE0812MP	35.60
13"	BE0813MP	37.40
14"	BE0814MP	39.00
16"	BE0816MP	40.50

#### Ebony Suede Emperor™

6"	ES0806MP	\$29.50
8"	ES0808MP	32.30
10"	ES0810MP	33.60
12"	ES0812MP	35.60
13"	ES0813MP	37.40
14"	ES0814MP	39.00

#### Renaissance Emperor™

6"	RE0006MP	\$33.60
8"	RE0008MP	35.60
10"	RE0010MP	38.70
12"	RE0012MP	41.30
13"	RE0013MP	42.30
14"	RE0014MP	44.10
16"	RE0016MP	45.80

### Bass Drum (Crimplock)

#### Smooth White Ambassador™

16"	BR1216MP	\$68.90
18"	BR1218MP	71.80
20"	BR1220MP	75.60
22"	BR1222MP	81.80
24"	BR1224MP	86.10
26"	BR1226MP	97.40
28"	BR1228MP	105.30
30"	BR1230MP	113.00
32"	BR1232MP	122.00

#### Emperor™

16"	BB1216MP	\$68.90
18"	BB1218MP	71.80
20"	BB1220MP	75.60
22"	BB1222MP	81.80
24"	BB1224MP	86.10
26"	BB1226MP	97.40
28"	BB1228MP	105.30
30"	BB1230MP	113.00
32"	BB1232MP	122.00

### Powermax® 2 Bass Drum Heads

#### Ebony

14"	PM2414MP	\$76.10
16"	PM2416MP	80.50
18"	PM2418MP	85.80
20"	PM2420MP	88.20
22"	PM2422MP	96.10
24"	PM2424MP	102.20
26"	PM2426MP	109.20
28"	PM2428MP	122.00
30"	PM2430MP	135.30
32"	PM2432MP	146.80

#### Ultra White

14"	PM2014MP	\$68.90
16"	PM2016MP	73.50
18"	PM2018MP	78.20
20"	PM2020MP	80.20
22"	PM2022MP	87.40
24"	PM2024MP	92.80
26"	PM2026MP	100.50
28"	PM2028MP	110.70
30"	PM2030MP	123.00
32"	PM2032MP	135.80

#### Ebony™ Ambassador™

16"	ES1016MP	\$76.90
18"	ES1018MP	80.00
20"	ES1020MP	85.30
22"	ES1022MP	91.50

## WHITE/BLACK MAX

### Snare Drum

#### Black Max Batter

13"	KS0613	\$96.60
14"	KS0614	98.90

#### Snare Batter

13"	KS1613, Black w/underlay	\$100.50
14"	KS1614, Black w/underlay	103.80
13"	KS3613, White w/underlay	100.50
14"	KS3614, White w/underlay	103.80

#### White Max Batter

13"	KS2613	\$96.60
14"	KS2614	98.90

## POWERMAX BASS DRUMHEADS

#### Smooth White Crimplock

14"	PM1014MP	\$68.90
16"	PM1016MP	73.50
18"	PM1018MP	78.20
20"	PM1020MP	80.20
22"	PM1022MP	87.40
24"	PM1024MP	92.80
26"	PM1026MP	100.50
28"	PM1028MP	110.70
30"	PM1030MP	123.00
32"	PM1032MP	135.80

#### Black Suede

14"	PM1814MP	\$76.10
16"	PM1816MP	80.50
18"	PM1818MP	85.80
20"	PM1820MP	88.20
22"	PM1822MP	96.10
24"	PM1824MP	102.20
26"	PM1826MP	109.20
28"	PM1828MP	122.00
30"	PM1830MP	135.30
32"	PM1832MP	146.80

#### Ebony Powermax

14"	PM1414MP	\$76.10
16"	PM1416MP	80.50
18"	PM1418MP	85.80
20"	PM1420MP	88.20
22"	PM1422MP	96.10
24"	PM1424MP	102.20
26"	PM1426MP	109.20
28"	PM1428MP	122.00
30"	PM1430MP	135.30
32"	PM1432MP	146.80

### Cybermax Marching Drumhead

#### Extreme tension & durability

13"	KS0523	\$100.50
14"	KS0524	103.80

## FALAMS K-SERIES

#### Coated

13"	KS0113	\$75.60
14"	KS0114	78.40

#### Smooth White

13"	KS0213	\$75.60
14"	KS0214	78.40

#### Smooth White w/Clear Dot

13"	KS0213C2	\$80.00
14"	KS0214C2	81.70

#### Neutral

14"	KS0414	\$78.40
-----	--------	---------

#### Neutral w/Clear Dot

14"	KS0414C2	\$81.70
-----	----------	---------

#### Snare Side – Smooth White

13"	KL0213SA	\$81.70
14"	KL0214SA	75.60

## FALAMS XT

#### Marching w/Underlay Ring

#### Smooth White

13"	KL1213SA	\$75.00
14"	KL1214SA	78.70

www.remo.com

**FAX & E-MAIL ORDERS FOR PRINTED MUSIC WILL GET AN EXTRA 5% DISCOUNT**

**FAX: (708) 496-2130 or (888) 983-5537 • E-MAIL: sales@harristeller.com**

# REMO

## RENAISSANCE

### BATTER DIPLOMAT

RD0008SS.....	<b>\$31.00</b>
RD0010SS.....	<b>34.60</b>
RD0012SS.....	<b>36.75</b>
RD0013SS.....	<b>39.00</b>
RD0014SS.....	<b>40.70</b>
RD0015SS.....	<b>43.60</b>
RD0016SS.....	<b>44.00</b>
RD0018SS.....	<b>54.80</b>
RD0020SS.....	<b>62.50</b>

### EMPEROR

RE0006SS.....	<b>\$31.00</b>
RE0008SS.....	<b>30.75</b>
RE0010SS.....	<b>34.60</b>
RE0012SS.....	<b>38.40</b>
RE0013SS.....	<b>39.00</b>
RE0014SS.....	<b>40.70</b>
RE0015SS.....	<b>41.50</b>
RE0016SS.....	<b>45.10</b>
RE0018SS.....	<b>53.50</b>

### SNARE SIDE

SA0010SS.....	<b>\$24.50</b>
SA0012SS.....	<b>29.50</b>
SA0013SS.....	<b>31.50</b>
SA0014SS.....	<b>32.50</b>
SA0015SS.....	<b>34.10</b>

### BATTER AMBASSADOR\*

RA0006SS.....	<b>\$31.00</b>
RA0008SS.....	<b>31.50</b>
RA0010SS.....	<b>34.60</b>
RA0012SS.....	<b>38.40</b>
RA0013SS.....	<b>39.00</b>
RA0014SS.....	<b>40.70</b>
RA0015SS.....	<b>43.60</b>
RA0016SS.....	<b>45.10</b>
RA0018SS.....	<b>53.50</b>
RA0020SS.....	<b>61.00</b>

### BASS AMBASSADOR\*

RA1016SS.....	<b>\$76.90</b>
RA1018SS.....	<b>79.20</b>
RA1020SS.....	<b>81.70</b>
RA1022SS.....	<b>86.40</b>
RA1024SS.....	<b>91.00</b>
RA1026SS.....	<b>99.90</b>
RA1028SS.....	<b>106.90</b>
RA1030SS.....	<b>114.30</b>
RA1032SS.....	<b>126.60</b>
RA1036SS.....	<b>156.60</b>
RA1040SS.....	<b>185.00</b>

## SNARE SIDE

DIA.	DIPLOMAT	AMBASSADOR	EMPEROR	PRICE
10"	SD0110	SA0110		<b>\$22.80</b>
12"		SA0112		<b>24.60</b>
13"	SD0113	SA0113	SA0313TD	<b>SE0113 26.10</b>
14"	SD0114	SA0114	SA0314TD	<b>SE0114 27.70</b>
15"	SD0115	SA0115	SA0315TD	<b>28.40</b>

## SNARE BATTER - EMPEROR™

Size	Bottom Blk Dot Coated	Top Clear Dot Coated	Price
12"	BE011210		<b>\$31.50</b>
13"		BE011322	<b>31.00</b>
14"	BE011410	BE011422	<b>34.60</b>

## CONTROLLED SOUND X-BATTER

Size	Bottom Black Dot Coated	Price
10"	CX011010	<b>\$27.70</b>
12"	CX011210	<b>31.00</b>
13"	CX011310	<b>32.50</b>
14"	CX011410	<b>34.10</b>

## SKYNTONE SNARE

The Skyntone™ drumhead is designed for use on snare drums for both **concert and drum set applications.**

SK0013	Batter, Skyntone, 13" Diameter	<b>\$35.60</b>
SK0014	Batter, Skyntone, 14" Diameter	<b>37.20</b>

## BLACK SUEDE

	Ambassador	Emperor®	Price
8"	BA0808ES	BE0808ES	<b>\$29.50</b>
10"	BA0810ES	BE0810ES	<b>30.50</b>
12"	BA0812ES	BE0812ES	<b>33.60</b>
13"	BA0813ES	BE0813ES	<b>34.60</b>
14"	BA0814ES	BE0814ES	<b>35.60</b>
16"	BA0816ES	BE0816ES	<b>40.70</b>

## BLACK X

13"	BX081310	Black Dot Bottom	<b>\$37.40</b>
14"	BX081410	Black Dot Bottom	<b>40.70</b>

## ROCK AND ROSES GRAPHIC

TT0813AXT5	13" Batter, Suede.....	<b>\$39.20</b>
TT0814AXT5	14" Batter, Suede.....	<b>41.30</b>
PA1320TTT5	20" Bass, White.....	<b>98.40</b>
PA1320TTT7	20" Bass, Black.....	<b>98.40</b>
PA1322TTT5	22" Bass, White.....	<b>113.80</b>
PA1322TTT7	22" Bass, Black.....	<b>113.80</b>

## DRAGON SKYN GRAPHIC

TT0813AXT6	13" Batter, Suede.....	<b>\$39.20</b>
TT0814AXT6	14" Batter, Suede.....	<b>41.30</b>
PA1320TTT6	20" Bass, White.....	<b>98.40</b>
PA1320TTT8	20" Bass, Black.....	<b>98.40</b>
PA1322TTT6	22" Base, White.....	<b>113.80</b>
PA1322TTT8	22" Base, Black.....	<b>113.80</b>

## TATOO SKINS

TT0813AXT1	Batter, 13", 'B&W Skulls'.....	<b>\$39.20</b>
TT0813AXT2	Batter, 13", 'B&W Serpent'.....	<b>39.20</b>
TT0814AXT1	Batter, 14", 'B&W Skulls'.....	<b>41.30</b>
TT0814AXT2	Batter, 14", 'B&W Serpent'.....	<b>41.30</b>
PA1322TTT1	Powerstroke, 22", 'Skulls on White'.....	<b>113.80</b>
PA1322TTT2	Powerstroke, 22", 'Serpent Rose'.....	<b>113.80</b>
PA1322TTT3	Powerstroke, 22", 'Skulls on Black'.....	<b>113.80</b>
PA1322TTT4	Powerstroke, 22", 'Serpent Rose'.....	<b>113.80</b>

## FREE WITH 100 ASSORTED REMO HEADS

### Countertop Two (2) Tier Drumhead Display



Remo introduces a new 2 Tier Countertop Point of Purchase drumhead display rack. Product information graphics, and our new color coding system are printed on the top and sides. Dimensions: 37"H x 39.5" W x 17"D

<b>Model No.</b>	<b>Holds</b>	<b>Sizes</b>
D10024	75 Drumheads (boxed)	6" - 16"

## FREE WITH 150 ASSORTED REMO HEADS

### Three (3) Tier Drumhead Display Rack



Three (3) Tier Point of Purchase drumhead display rack. Product information graphics, and our new color coding system are printed on both sides. Dimensions: 82"H x 39.5"W x 22"D.

<b>Model No.</b>	<b>Holds</b>	<b>Sizes</b>
D10022	110 Drumheads (boxed)	6" - 22"

**DEALER NET ON EITHER WITHOUT HEADS IS \$150.00**

# REMO

## CONCERT BASS DRUM

Size	F1 (Heavy)	Price
28"	EE1528F1	\$122.20
30"	EE1530F1	131.20
32"	EE1532F1	151.20
36"	EE1536F1	186.00

## NUSKYN SYMPHONIC BASS DRUM

Size		Price
28"	N33028	\$115.80
30"	N33030	133.10
32"	N33032	149.90
36"	N33036	190.10
40"	N33040	329.20

## ROTOTOM TIMPANI HEADS

6"	TI0306	\$24.30B
8"	TI0308	24.60B
10"	TI0310	25.90B
12"	TI0312	27.70B
14"	TI0314	31.00B
16"	TI0316	34.10B
18"	TI0318	40.75B

## NUSKYN™ WORLD PERCUSSION HEADS

### NuSkyn™ Type 6 (Conga Vintage Wrap™) For Drum

Size	Special	Special	Quinto	Conga	Tumba	Super Tumba	Price
10"	M4S100N1						\$94.60B
11"			M71106N6				98.90B
11.75"				M71175N6			101.70B
12.5"					M71250N6		104.30B
13"				M71300F6		M71300N6	109.40B

### Fiberskyn® 3 – Type 6 (Bongo)

Size	Type	Pearl	LP	Remo®	Toca	Price
7"	Small Bongo	M60715F1	M60715F1	M60715F1	M60715F1	\$54.60B
8"	Med Bongo	M6S800F3				38.70B

### NuSkyn™ – Type 5 (Djembé Open Channel)

Size	Djembé	Price
14"	M51402N2	\$78.70B

Developed for use on rope-tensioned drums with wood counterhoops, Type 5 heads have a medium high, straight collar and aluminum hoop.

### NuSkyn™ – Type 8 (Djembé Vintage Wrap™)

Size	Djembé	Price
14"	M81400N2	\$92.50B

NuSkyn™ Type 7 heads are wrapped around a solid tension ring.

### NuSkyn™ – Type 9 (Bongo Vintage Wrap™)

Size	Bongo	Price
6.75"	M6S675N1	\$47.20B
7.15"	M90715N5	63.60B
8.5"	M90850N6	70.50B
9"	M90900N6	76.40B

NuSkyn™ Type 7 heads are wrapped around a solid tension ring.



## BONGO HEADS

BONGO ORIGIN	HEAD SIZE O.D. INCHES	FIBERSKYN 2 FILM	PRICE
Japan	Small 7 1/16"	BG-0701-J5	\$41.80B
Japan	Large 8 7/16"	BG-0807-J5	45.10B
Gon Bops	Small 7 13/16"	BG-0713-G5	41.80B
Gon Bops	Large 8 13/16"	BG-0813-G5	45.10B
Latin Percussion (USA)	Small 8 7/8"	BG-0801-L5	45.10B
Latin Percussion (USA)	Large 9 7/16"	BG-0904-L5	47.20B
Latin Percussion (Taiwan)	Large 9 7/16"	BG-0907-L5	47.20B
USA*	Small 6 1/2"	BG-0608-A5	31.00B
USA*	Large 8 1/2"	BG-0808-A5	45.40B
Europe	Small 7 7/8"	BG-0706-E5	41.80B

## REMO BANJO HEADS

Shell Diam.	Collar	Coated Topside	Coated Underside	Transparent	Fiberskyn 3
11"	Low	BJ1100L1	BJ1100L2	BJ1100L3	BJ1100L5
11 1/8"	Low	BJ1102L1	BJ1102L2	BJ1102L3	
11"	Med.	BJ1100M1	BJ1100M2	BJ1100M3	
10 3/4"	High	BJ1012H1	BJ1012H2	BJ1012H3	
10 7/8"	High	BJ1014H1	BJ1014H2	BJ1014H3	
10 15/16"	High	BJ1015H1	BJ1015H2	BJ1015H3	BJ1015H5
11"	High	BJ1100H1	BJ1100H2	BJ1100H3	BJ1100H5
11 1/16"	High	BJ1101H1	BJ1101H2	BJ1101H3	
11 7/8"	High	BJ1102H1	BJ1102H2	BJ1102H3	
<b>PRICE</b>		<b>\$32.30</b>	<b>\$32.30</b>	<b>\$32.30</b>	<b>\$35.90</b>

(Low= 3/8", Med = 7/16", High = 1/2")

### 5 \* BANJO HEADS

<b>SM100C</b>	Clear, Med. Crown, 11" Dia.....	\$42.00
<b>SM100F</b>	Frosted, Med. Crown, 11" Dia.....	42.00
<b>SM100W</b>	White, Med. Crown, 11" Dia.....	42.00

**IF YOU ARE LOOKING FOR A REMO PRODUCT AND DON'T SEE IT LISTED, GIVE US A CALL. SPECIAL ORDERS ARE AVAILABLE.**

www.remo.com

# REMO

## FIBERSKYN 3 WORLD PERCUSSION HEADS

### Tucked Fiberskyn™ 3 Conga Drumheads

<b>M71106F6</b>	M7 Type Tucked, F7 Film, 11.00" Diameter.....	<b>\$98.90B</b>
<b>M71175F6</b>	M7 Type Tucked, F7 Film, 11.75" Diameter.....	<b>101.70B</b>
<b>M71250F6</b>	M7 Type Tucked, F7 Film, 12.50" Diameter.....	<b>104.30B</b>
<b>M71300F6</b>	M7 Type Tucked, F7 Film, 13.00" Diameter.....	<b>109.40B</b>
<b>M7S100F5</b>	M7 Type S-Series, Tucked, F5 Film, 10.00" Diameter.....	<b>94.00B</b>
<b>M7S110F5</b>	M7 Type S-Series, Tucked, F5 Film, 11.00" Diameter.....	<b>94.00B</b>

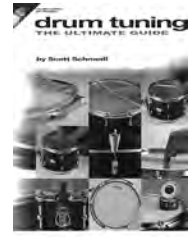

### Tucked Fiberskyn™ 3 Bongo Drumheads

<b>M90715F3</b>	M9 Type Tucked, F3 Film, 7.15" Diameter.....	<b>\$63.60B</b>
<b>M90850F4</b>	M9 Type Tucked, F4 Film, 8.50" Diameter.....	<b>70.50B</b>



### Fiberskyn® 3 - Type 2

Size	FD (Thin) Djembe	FA (Medium) Djembe Ashiko	Price	F2 (Super Heavy) 100-Series Tubanos Standing Ngomas	Price
2.5 x 10"		MO2510FA.....	<b>\$51.00B</b>	MO2510F5.....	<b>\$52.25B</b>
2.5 x 12"		MO2512FA.....	<b>60.00B</b>	MO2512F5.....	<b>63.50B</b>
2.5 x 14"		MO2514FA.....	<b>69.80B</b>		
2.5 x 16"		MO2516FA.....	<b>76.70B</b>		
2.5 x 18"	MO2518FD.....		<b>85.70B</b>		
2.5 x 22"					

**Drum Tuning –**  
The Ultimate Guide Bk/CD ..... **\$14.95**

**Drummers Toolkit –**  
Most Complete Reference  
Guide Available Bk/DVD..... **19.95**

### Ergo Heads

Model		Price
BD0008	Diplomat, Skin Deep, 8" Diameter, 'Fish Skin' Graphic.....	<b>\$27.70</b>
BD0009	Diplomat, Skin Deep, 9" Diameter, 'Fish Skin' Graphic.....	<b>26.90</b>
BD0010	Diplomat, Skin Deep, 10" Diameter, 'Fish Skin' Graphic.....	<b>27.40</b>
M51000S2	Skyndeep™, M5 Type, S2 Film, 10" 'Calfskin' Graphic.....	<b>57.40B</b>



### Key Tuned Djembe Heads

MO2510SD	10", 2.5" Collar.....	<b>\$51.20B</b>
MO2512SD	12", 2.5" Collar.....	<b>58.90B</b>
SD = Black Fiberskyn Graphic		

### Fiberskyn® 3 Bongo Drumheads

Low Collar for Curved Hoops

Size	50-series	Price
8.5"	M6S850F5.....	<b>\$54.35B</b>
9"	M6S900F5.....	<b>59.25B</b>
6.75"	M6S675FD.....	<b>29.50B</b>
8"	M6S800F3.....	<b>38.70B</b>

### NUSKYN® Type 6 (Bongo) S-Series

Size	Model	Price
6.75"	M6S675N1.....	<b>\$47.20B</b>
8.00"	M6S800N1.....	<b>57.90B</b>

Fits: LP Aspire, MEINL Headliner

### Fiberskyn® 3 Conga Drumheads

Low Collar for Curved Hoops

Size	50-series	Price
11"	M4S110F5.....	<b>\$76.50B</b>

### Fiberskyn® 3 - Type 4 (Conga)

For Drum Size	Type	LP	REMO	Price
10"	Super Quinto			<b>\$76.60B</b>
11.75"	Conga		M41175R5	<b>87.75B</b>
12.25"		M41225LP		<b>93.40B</b>

# REMO TIMPANI HEADS

## No Insert Ring (Standard)

Size	Hazy	Clear	Price
20"	T1200000	T1200003	\$80.00
20 <sup>19</sup> / <sub>16</sub> "	T1201000	T1201003	83.30
21"	T1210000	T1210003	85.30
22"	T1220000	T1220003	78.70
22 <sup>9</sup> / <sub>16</sub> "	T1220800	T1220803	91.00
23"	T1230000	T1230003	94.00
23 <sup>9</sup> / <sub>16</sub> "	T1230800	T1230803	95.80
24"	T1240000	T1240003	97.60
24 <sup>1</sup> / <sub>16</sub> "	T1240400	T1240403	85.30
25"	T1250000	T1250003	87.60
25 <sup>9</sup> / <sub>16</sub> "	T1250800	T1250803	100.50
26"	T1260000	T1260003	88.90
26 <sup>9</sup> / <sub>16</sub> "	T1260800	T1260803	102.80
27"	T1270000	T1270003	91.00
27 <sup>9</sup> / <sub>16</sub> "	T1270800	T1270803	104.30
27 <sup>13</sup> / <sub>16</sub> "	T1271200	T1271203	106.90
28"	T1280000	T1280003	93.00
28 <sup>8</sup> / <sub>16</sub> "	T1280800	T1280803	95.60
29"	T1290000	T1290003	95.60
30"	T1300000	T1300003	97.10
30 <sup>9</sup> / <sub>16</sub> "	T1300800	T1300803	113.80
31"	T1310000	T1310003	98.90
31 <sup>9</sup> / <sub>16</sub> "	T1310800	T1310803	117.90
32"	T1320000	T1320003	103.80
33"	T1330000	T1330003	110.40
33 <sup>8</sup> / <sub>16</sub> "	T1330800	T1330803	132.70
34"	T1340000	T1340003	115.30
34 <sup>8</sup> / <sub>16</sub> "	T1340800	T1340803	163.50
34 <sup>12</sup> / <sub>16</sub> "	T1341200	T1341203	177.10
35"	T1350000	T1350003	191.20

## Steel or Aluminum Insert Ring

Size	Custom	Price	Renaissance®	Price
20"	TC2000LA	\$155.00	RC2000LA	\$164.30
20 <sup>19</sup> / <sub>16</sub> "	TC2010LA	157.10	RC2010LA	167.10
21"	TC2100LA	157.60	RC2100LA	168.90
22"	TC2200LA	158.90	RC2200LA	169.40
22 <sup>9</sup> / <sub>16</sub> "	TC2208LA	160.40	RC2208LA	171.90
23"	TC2300LA	162.00	RC2300LA	173.70
23 <sup>9</sup> / <sub>16</sub> "	TC2308LA	162.70	RC2308LA	175.30
24"	TC2400LA	164.30	RC2400LA	175.80
24 <sup>1</sup> / <sub>16</sub> "	TC2404LA	165.30	RC2404LA	177.80
25"	TC2500LA	169.10	RC2500LA	182.50
25 <sup>9</sup> / <sub>16</sub> "	TC2508LA	169.40	RC2508LA	183.70
26"	TC2600LA	170.70	RC2600LA	185.00
26 <sup>9</sup> / <sub>16</sub> "	TC2608LA	173.50	RC2608LA	187.10
27"	TC2700LA	174.50	RC2700LA	188.30
27 <sup>9</sup> / <sub>16</sub> "	TC2708LA	175.50	RC2708LA	191.40
27 <sup>13</sup> / <sub>16</sub> "	TC2712LA	177.10	RC2712LA	192.40
28"	TC2800LA	179.40	RC2800LA	193.50
28 <sup>8</sup> / <sub>16</sub> "	TC2808LA	180.90	RC2808LA	195.80
29"	TC2900LA	182.50	RC2900LA	204.20
30"	TC3000LA	183.00	RC3000LA	207.10
30 <sup>9</sup> / <sub>16</sub> "	TC3008LA	185.50	RC3008LA	208.80
31"	TC3100LA	186.60	RC3100LA	210.40
31 <sup>9</sup> / <sub>16</sub> "	TC3108LA	188.10	RC3108LA	211.90
32"	TC3200LA	189.60	RC3200LA	213.50
33"	TC3300LA	192.20	RC3300LA	215.30
33 <sup>8</sup> / <sub>16</sub> "	TC3308LA	197.80	RC3308LA	216.00
34"	TC3400LA	199.10	RC3400LA	219.40
34 <sup>8</sup> / <sub>16</sub> "	TC3408LA	200.40	RC3408LA	220.90
34 <sup>12</sup> / <sub>16</sub> "	TC3412LA	202.40	RC3412LA	220.90
35"	TC3500LA	221.40	RC3500LA	243.20

To order a TC-or RC-Tympani, use the standard "-LA suffix or substitute from the choices below.

RA Aluminum Insert / Hazy Film

SA Steel Insert / Hazy Film

LA Low-Profile Steel / Hazy Film

RS Aluminum "Clear"

SS Steel Insert / Clear Film

LS Low-Profile Steel / Clear Film

## REPLACEMENT HEAD TABLE

(TIMPANI HEADS MAY NOT BE RETURNED)

BOWL SIZE	18" 45.7cm	19" 48.2cm	20" 50.8cm	21.5" 52.5cm	22" 55.9cm	23" 58.4cm	24" 60.9cm	25" 63.5cm	26" 66.0cm	27" 68.8cm	28" 71.1cm	29" 73.7cm	30" 76.2cm	31" 78.7cm	32" 81.3cm
ADAMS (Most Models) (Philharmonic)			2200 2300	2500		2500 2508		2708	2800 2808		3008	3100 3200	3300		3400 3412
AEHNELT (Munich) (Berlin)				2400	2500	2600		2712	2800 2808		3100	3200		3308	3408
AMERICAN DRUM (Continental) (Dresden)*		2200	2300	2400 2400		2600 2600	2700	2800	2900 2800		3100	3200 3108	3300	3300	3500
CLEVELANDER			2200				2600	2800	2808			3108		3300	3500
GP PERCUSSION (Standard) (Baroque)					2308		2608 2508		2808			3108			3500
GOODMAN (Chain) (Dresden) (Dresden)	2000		2200		2400	2500 2508 (2500)	2600	2700 2712 (2800)	2800	2900 (3008)	3000 3100	3100	3200	3300	
HINGER (Dresden or Cable)			2300		2500	2600		2800			3100			3400	3412
JENCO (Dresden or Rotary)						2608		2708	2708			3008	3300		
KOLBERG					2308		2600		2800			3100		3300	
WALTER LIGHT (After 1986)								2708	2808		3008			3400	
LEFIMA (Dresden)					2500	2600		2700 2808		2800		3100		3300	
LEFIMA (Voyager I & II) (Baroque) (Light)					2404 2404			2608 2608	2712		3000			3300	
LUDWIG RINGER/ROGERS (Dbl. Suspension Bowl)		Post 1978	2200			2500			2800			3100			3400
LUDWIG*/SLINGERLAND LEEDY 7 LUDWIG/WFL		Pre 1978	(2010)			2404	2500	2600	2700	2800	2900	3000	3100		
MAJESTIC			2200			2500			2800			3100			3400
PEARL						2500			2800			3100			3400
PREMIER (Standard) (International) (Elite)					2308 2600	2500		2600	2800	2800	2900	3100	3100	3300	3500
GUNTHER RINGER (Dresden)			2208			2500		2708			3008		3200		
STOTZ (Cable)			2300		2500	2600	2700	2800	2900	3000	3100	3200	3300	3400	3500
YAMAHA			2200			2500			2800			3100			3400



# ATTACK



## 2-Ply Clear/Ridge

6"	DH6	<b>\$21.00</b>
8"	DH8	<b>\$21.00</b>
10"	DH10	<b>\$23.50</b>
12"	DH12	<b>\$31.75</b>
13"	DH13	<b>\$34.00</b>
14"	DH14	<b>\$37.75</b>
14"	DH14C 2-ply coated	<b>\$41.50</b>
15"	DH15	<b>\$41.00</b>
16"	DH16	<b>\$45.75</b>
18"	DH18	<b>\$57.00</b>
20"	DH20	<b>\$68.00</b>
22"	DH22	<b>\$85.00</b>

## 1-Ply Clear

DHA6	<b>\$16.50</b>
DHA8	<b>\$17.75</b>
DHA10	<b>\$19.75</b>
DHA12	<b>\$21.50</b>
DHA13	<b>\$23.75</b>
DHA14	<b>\$24.50</b>
DHA16	<b>\$28.25</b>
DHA18	<b>\$36.00</b>
DHA20	<b>\$58.50</b>
DHA22	<b>\$59.50</b>
DH22P Black/Ported 4"	<b>\$72.75</b>

## 1-Ply Coated

DHA8C	<b>\$17.75</b>
DHA12C	<b>\$21.50</b>
DHA13C	<b>\$23.75</b>
DHA14C	<b>\$24.50</b>
DHA15C	<b>\$27.00</b>
DHA16C	<b>\$28.25</b>

## TERRY BOZZIO SERIES

1-Ply Clear	1-Ply Coated
TB10	TB10C
<b>\$23.75</b>	<b>\$20.75</b>
TB12	TB12C
<b>\$24.75</b>	<b>\$24.75</b>
TB13	TB13C
<b>\$33.75</b>	<b>\$28.75</b>
TB14	TB14C
<b>\$32.25</b>	<b>\$33.25</b>
TB16	TB16C
<b>\$41.50</b>	<b>\$41.50</b>
TB18	
<b>\$53.25</b>	
TB20	TB20C
	<b>\$78.25</b>
TB22	
<b>\$83.00</b>	
TB26C	
	<b>\$109.25</b>

## THIN SKIN 2™ 2 Ply Clear

DHTS2-6	6" 2 ply clear	<b>\$21.50</b>
DHTS2-10	10" 2 ply clear	<b>23.50</b>
DHTS2-12	12" 2 ply clear	<b>30.25</b>
DHTS2-13	13" 2 ply clear	<b>33.25</b>
DHTS2-13C	13" 2 ply coated	<b>33.25</b>
DHTS2-14	14" 2 ply clear	<b>36.00</b>
DHTS2-14C	14" 2 ply coated	<b>36.00</b>
DHTS2-15	15" 2 ply clear	<b>42.50</b>
DHTS2-16	16" 2 ply clear	<b>44.75</b>
DHTS2-18	18" 2 ply clear	<b>57.00</b>
DHTS2-20	20" 2 ply clear	<b>82.50</b>
DHTS2-22	22" 2 ply clear	<b>97.50</b>
DHTS2-24	24" 2 ply clear	<b>98.50</b>

## THIN SKIN 2™ 1 Ply Clear

DHTS-6	6" 1 ply clear	<b>\$16.50</b>
DHTS-12	12" 1 ply clear	<b>20.50</b>
DHTS-13	13" 1 ply clear	<b>23.75</b>
DHTS-14	14" 1 ply clear	<b>24.50</b>
DHTS-15	15" 1 ply clear	<b>27.00</b>

## SNARE SIDE

SS12T	12" thin snare side	<b>\$20.50</b>
SS13M	13" med. snare side	<b>21.00</b>
SS13T	13" thin snare side	<b>21.00</b>
SS14M	14" med. snare side	<b>21.50</b>
SS14T	14" thin snare side	<b>21.50</b>

No  
Overtone  
Clear  
22" TBN022  
**\$86.25**

COATED BATTER SIDE  
Bottom Dot  
12" TBB12  
**\$35.25**

Coated  
20" TBN020C  
**\$80.00**  
22" TBN022C  
**\$95.00**  
24" TBN024C  
**\$107.25**

SNARE SIDE  
12" TBSS12  
**\$27.75**  
13" TBSS13  
**\$30.25**  
14" TBSS14  
**\$32.25**

## SAMPLER PACKS

1 12" 2 ply medium clear  
1 13" 2 ply medium clear  
1 14" 2 ply medium clear  
1 16" 2 ply medium clear  
1 22" 2 ply medium clear

**DHAA.....\$244.45**

DHA12 1 ply Med Clear 12"  
DHA13 1 ply Med Clear 13"  
DHA16 1 ply Med Clear 16"  
DHA14C 1 ply Med Coated 14"  
DHN022 1 ply Med Clear 22"

**DHAB.....\$149.50**

1 12" (DHA12) 1 ply clear  
1 13" (DHA13) 1 ply clear  
1 14" (DHA14) 1 ply clear  
1 14" (DHA14C) 1ply coated  
1 16" (DHA16) 1 ply clear  
1 22" (DHA22) 1 ply clear

**DHAD.....\$112.50**

DHA12 1 ply Med Clear 12"  
DHA13 1 ply Med Clear 13"  
DHA16 1 ply Med Clear 16"  
DHA14C 1 ply Med Coated 14"

**DHAI.....\$97.80**

# AQUARIAN

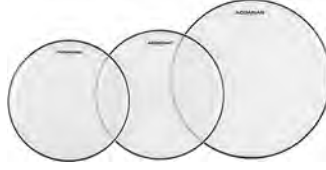

## STUDIO-X

Muffling Ring		
AQ SX6	6"	\$20.00
AQ SX8	8"	22.00
AQ SX10	10"	23.00
AQ SX12	12"	25.00
AQ SX13	13"	26.00
AQ SX14	14"	27.00
AQ SX15	15"	28.00
AQ SX 16	16"	32.00
AQ SX 18	18"	37.00

## TEXTURE COATED STUDIO-X™

AQ TCSX6	6"	\$23.00
AQ TCSX8	8"	24.00
AQ TCSX10	10"	26.00
AQ TCSX12	12"	28.00
AQ TCSX13	13"	29.00
AQ TCSX14	14"	31.00
AQ TCSX15	15"	32.00
AQ TCSX16	16"	37.00
AQ TCSX18	18"	42.00

## BASS DRUMHEADS

AQ TCSX20	20"	\$49.00
AQ TCSX22	22"	58.00
AQ TCSX24	24"	63.00
AQ TCSX26	26"	68.00

## STUDIO X WITH POWER DOT

AQ SXPD8	8"	\$24.00
AQ SXPD10	10"	26.00
AQ SXPD12	12"	28.00
AQ SXPD13	13"	29.00
AQ SXPD14	14"	31.00
AQ SXPD15	15"	32.00
AQ SXPD16	16"	37.00
AQ SXPD18	18"	42.00
AQ SXPD20	20"	49.00
AQ SXPD22	22"	58.00
AQ SXPD24	24"	63.00

## RESPONSE 2

AQ RSP210	10"	\$24.00
AQ RSP212	12"	27.00
AQ RSP213	13"	29.00
AQ RSP214	14"	31.00
AQ RSP215	15"	32.00
AQ RSP216	16"	37.00
AQ RSP218	18"	41.00
AQ RSP220	20"	48.00
AQ RSP222	22"	52.00
AQ RSP224	24"	57.00

## TEXTURE COATED RESPONSE 2

AQ TCRSP28	8"	\$24.00
AQ TCRSP210	10"	26.00
AQ TCRSP212	12"	30.00
AQ TCRSP213	13"	32.00
AQ TCRSP214	14"	34.00
AQ TCRSP215	15"	35.00
AQ TCRSP216	16"	42.00
AQ TCRSP218	18"	43.00

## BASS DRUMHEADS

AQ TCRSP2-20	20"	\$56.00
(also available in black)		

## CLASSIC CLEAR

AQ CC8	8"	\$18.00
AQ CC10	10"	20.00
AQ CC12	12"	21.00
AQ CC13	13"	22.00
AQ CC14	14"	23.00
AQ CC15	15"	24.00
AQ CC16	16"	26.00
AQ CC18	18"	31.00
AQ CC22	22"	43.00

## CLASSIC CLEAR, BLACK

AQ CC10BK	10"	\$23.00
AQ CC12BK	12"	24.00
AQ CC13BK	13"	25.00
AQ CC14BK	14"	26.00
AQ CC16BK	16"	31.00

## CLASSIC CLEAR POWER DOT

AQ CCPD6	6"	\$19.00
AQ CCPD8	8"	20.00
AQ CCPD10	10"	22.00
AQ CCPD12	12"	24.00
AQ CCPD13	13"	25.00
AQ CCPD14	14"	26.00
AQ CCPD16	16"	31.00
AQ CCPD18	18"	36.00

## BASS DRUMHEADS

AQ CCPD22	22"	\$50.00
AQ CCPD24	24"	55.00

## PERFORMANCE II

AQ PF8	8"	\$23.00
AQ PF10	10"	24.00
AQ PF12	12"	27.00
AQ PF13	13"	29.00
AQ PF14	14"	31.00
AQ PF15	15"	32.00
AQ PF16	16"	37.00
AQ PF18	18"	41.00
AQ PF20	20"	48.00
AQ PF22	22"	52.00
AQ PF24	24"	57.00

## TEXTURE COATED

### PERFORMANCE II

AQ TCPF12	12"	\$30.00
AQ TCPF13	13"	32.00
AQ TCPD14	14"	31.00
AQ TCPF14	14"	34.00
AQ TCSXPD14	14"	37.00
AQ TCPF16	16"	42.00

### PERFORMANCE II W/POWERDOT™

AQ QFPD6	6"	\$23.00
AQ QFPD8	8"	24.00
AQ QFPD10	10"	26.00
AQ QFPD12	12"	30.00
AQ QFPD13	13"	32.00
AQ QFPD14	14"	34.00
AQ QFPD15	15"	35.00
AQ QFPD16	16"	42.00
AQ QFPD18	18"	47.00

## Bass Drumheads

AQ QFPD18B	18"	\$56.00
AQ QFPD22	22"	60.00
AQ QFPD24	24"	65.00

## AMERICAN VINTAGE

### MEDIUM WEIGHT

AQ VTCM12	12"	\$32.00
AQ VTCM13	13"	34.00
AQ VTCM14	14"	35.00
AQ VCCSN14	14" Snare Side	23.00
AQ VTCM15	15"	36.00
AQ VTCM16	16"	40.00
AQ VTCM18	18"	45.00
AQ VTCM20	20"	51.00
AQ VTCM22	22"	57.00
AQ VTCM26	26"	69.00
(with felt strip)		
AQ VTCK20	20"	76.00
AQ VTCK22	22"	82.00
AQ VTCK26	26"	95.00

## MODERN TEXTURE COAT

### MEDIUM WEIGHT

AQ MOTCM6	6"	\$28.00
AQ MOTCM10	10"	31.00
AQ MOTCM12	12"	32.00
AQ MOTCM13	13"	34.00
AQ MOTCM14	14"	35.00
AQ MOTCM15	15"	36.00
AQ MOTCM16	16"	40.00
AQ MOTCM18B	18"	51.00
AQ MOTCM22	22"	57.00
AQ MOTCM24	24"	63.00
AQ MOTCM26	26"	69.00

## TEXTURED COATED

AQ TC12	12"	\$24.00
AQ TC13	13"	25.00
AQ TC14	14"	26.00
AQ TC15	15"	28.00
AQ TC16	16"	31.00
AQ TC18	18"	37.00
AQ TC22	22"	49.00

## SUPER 2

### CLEAR 2 PLY

AQ S208	8"	\$23.00
AQ S210	10"	24.00
AQ S212	12"	27.00
AQ S213	13"	29.00
AQ S214	14"	31.00
AQ S216	16"	37.00

## COATED

AQ TCS28	8"	\$24.00
AQ TCS210	10"	26.00
AQ TCS212	12"	30.00
AQ TCS13	13"	32.00
AQ TCS14	14"	34.00
AQ TCS215	15"	35.00
AQ TCS216	16"	42.00
AQ TCS218	18"	47.00

## FOCUS X TEXTURE COATED

AQ TCFX12	12"	\$31.00
AQ TCFX13	13"	32.00
AQ TCFX14	14"	33.00
AQ TCFX16	16"	42.00
AQ TCFX18	18"	47.00

## FOCUS X CLEAR

AQ CCFX8	8"	\$24.00
AQ CCFX10	10"	26.00
AQ CCFX13	13"	29.00
AQ CCFX14	14"	31.00
AQ CCFX15	15"	32.00
AQ CCFX16	16"	37.00

## FOCUS X TEXTURE COATED

### REVERSE DOT

AQ TCFXPD8	8"	\$28.00
AQ TCFXPD12	12"	31.00
AQ TCFXPD13	13"	32.00
AQ TCFXPD14	14"	33.00
AQ TCFXPD15	15"	35.00
AQ TCFXPD16	16"	42.00
AQ TCFXPD18	18"	47.00

## FOCUS X SNARE

AQ TCFX13	13"	\$32.00
AQ TCFX14	14"	33.00

## SNARE

AQ HE14	14"	\$32.00
AQ HPSN14	14"	23.00

## NEW ORLEANS SPECIAL

AQ NOS14	14"	\$32.00
----------	-----	---------

## CLASSIC CLEAR SNARE HEAD

AQ CCSN14	14"	\$21.00
-----------	-----	---------

## TRIPLE THREAT™ SNARE

### DRUMHEADS COATED ONLY

Three 7 mil		
AQ TRP14	14"	\$42.00
AQ TRP13	13"	40.00

## HI VELOCITY

AQ VEL13BK	13"	\$32.00
AQ VEL14BK	14"	34.00
AQ VEL13	13"	32.00
AQ VEL14	14"	34.00

## JACK DE JOHNETTE

AQ JD6	6"	\$28.00
AQ JD8	8"	30.00
AQ JD10	10"	32.00
AQ JD12	12"	34.00
AQ JD13	13"	35.00
AQ JD14	14"	36.00
AQ JD15	15"	37.00
AQ JD16	16"	39.00
AQ JD22	22"	57.00

PRICES SUBJECT TO CHANGE WITHOUT NOTICE

www.aquariandrumheads.com

# AQUARIAN

## PORTED BASS DRUMHEADS

(Black Finish) 7" Hole

AQPTCC20BK 20".....	\$69.00
AQPTCC22BK 22".....	77.00
AQPTCC24BK 24".....	81.00

## SMALL PORTED BASS DRUMHEADS 4 3/4" HOLE

(Side Ported, Clear)

AQSMPTBK20 20" Black.....	\$69.00
AQSMPTBK22 22" Black.....	77.00

## REGULATOR™

Available in black & white only.

AQRF20 20" Full Head.....	\$75.00
AQRF22 22".....	84.00
AQRF24 24".....	89.00

AQRSM20 20" Sm Hole 4 3/4".....	\$73.00
AQRSM22 22".....	84.00
AQRSM24 24".....	89.00
AQRSM26 26".....	95.00

AQRPT20 20" LG Hole 7".....	\$73.00
AQRPT22 22".....	84.00
AQRPT24 24".....	89.00

## IMPACT I BASS DRUM

A clear, single ply drumhead with the IMPACT muffling ring.

AQIMPI20 20".....	\$58.00
AQIMPI22 22".....	67.00
AQIMPI24 24".....	75.00
AQIMPI26 26".....	84.00

## IMPACT II BASS DRUM

A clear, two ply drumhead with the IMPACT muffling ring.

AQIMPII20 20".....	\$76.00
AQIMPII22 22".....	82.00
AQIMPII24 24".....	88.00

## IMPACT III BASS DRUM

A coated single ply drumhead with Power dot™ and the IMPACT ring.

AQIMPIII20 20".....	\$76.00
AQIMPIII22 22".....	82.00
AQIMPIII24 24".....	88.00
AQIMPIII26 26".....	94.00

## SUPER-KICK™ I BASS DRUM

A clear, single ply drumhead with the SUPER-KICK muffling ring.

AQSKI20 20".....	\$58.00
AQSKI22 22".....	67.00
AQSKI24 24".....	75.00
AQSKI26 26".....	84.00

## SUPER-KICK™ II BASS DRUM

A clear, two ply drumhead with the SUPER-KICK muffling ring.

AQSKII20 20".....	\$76.00
AQSKII22 22".....	82.00
AQSKII24 24".....	88.00
AQSKII26 26".....	94.00

## SUPER-KICK™ III BASS DRUM

A coated, single ply drumhead with AQUARIAN's patented Power dot™ and the SUPER-KICK muffling ring.

AQSKIII20 20".....	\$76.00
AQSKIII22 22".....	82.00
AQSKIII24 24".....	88.00
AQSKIII26 26".....	94.00

(also available in black)

## SUPER KICK10™

Two plies of 10mil

### BASS DRUMHEADS CLEAR

AQSK1018 18".....	\$80.00
AQSK1020 20".....	82.00
AQSK1022 22".....	88.00
AQSK1024 24".....	94.00
AQSK1026 26".....	100.00

### BASS DRUMHEADS COATED

AQTCISK1018 18".....	\$86.00
AQTCISK1020 20".....	88.00
AQTCISK1022 22".....	94.00
AQTCISK1024 24".....	100.00
AQTCISK1026 26".....	108.00

## FULL FORCE RESONANT BLACK

AQFR22BK 22".....	\$79.00
AQFR26BK 26".....	87.00

## FULL FORCE CLEAR

AQFB20 20".....	\$54.00
AQFB22 22".....	58.00
AQFB26 26".....	66.00

www.aquariandrumheads.com

## MARCHING SNARE DRUMHEADS PRECISION PARADE MYLAR

AQMPP13 13".....	\$34.05
------------------	---------

## CHEIFTAIN SNARE BOTTOM KEVLAR

AQMCHSB14 14".....	\$61.50
--------------------	---------

## SUPREME SNARE HEAD MYLAR

AQMSN14 14".....	\$25.00
AQMSN13 13".....	25.00

## FORCE TEN™

### CLEAR DRUMHEADS

#### TOM TOM HEADS (Two 10 mil)

AQFOR8 8".....	\$24.00
AQFOR10 10".....	26.00
AQFOR12 12".....	30.00
AQFOR13 13".....	32.00
AQFOR14 14".....	34.00
AQFOR15 15".....	35.00
AQFOR16 16".....	42.00
AQFOR18 18".....	47.00

## FORCE TEN™

### COATED DRUMHEADS (Two 10 mil)

AQTCFOR8 8".....	\$26.00
AQTCFOR10 10".....	28.00
AQTCFOR12 12".....	32.00
AQTCFOR13 13".....	34.00
AQTCFOR14 14".....	36.00
AQTCFOR15 15".....	37.00
AQTCFOR16 16".....	44.00
AQTCFOR18 18".....	49.00

## MARCHING BASS DRUMHEADS

### ARTICULATOR

AQMAB18 18".....	\$82.00
AQMAB20 20".....	85.00
AQMAB22 22".....	91.00
AQMAB24 24".....	96.00
AQMAB26 26".....	103.00
AQMAB28 28".....	110.00

(Available in Black, Add BK)

## MARCHING TOM TOM DRUMHEADS

### PROJECTOR (Black or White)

AQMPT6 6".....	\$29.00
AQMPT8 8".....	30.60
AQMPT10 10".....	33.00
AQMPT12 12".....	36.10
AQMPT13 13".....	38.10
AQMPT14 14".....	40.10

# LUDWIG

## LUDWIG TIMPANI HEADS-EXTENDED COLLAR/CLEAR

LC8123 23" Timpani Head.....	\$72.45B
LC8126 26" Timpani Head.....	76.65B
LC8129 29" Timpani Head.....	84.00B
LC8132 32" Timpani Head.....	90.30B

## LUDWIG TIMPANI HEADS-EXTENDED COLLAR/WHITE

LC8220 20" Timpani Head.....	\$70.55B
LC8223 23" Timpani Head.....	72.45B
LC8226 26" Timpani Head.....	76.65B
LC8229 29" Timpani Head.....	84.00B
LC8232 32" Timpani Head.....	90.30B

## LUDWIG TIMPANI HEADS-REGULAR COLLAR/CLEAR

LC9123 23" Timpani Head.....	\$72.45B
LC9125 25" Timpani Head.....	75.60B
LC9126 26" Timpani Head.....	76.65B
LC9129 29" Timpani Head.....	84.00B

## LUDWIG TIMPANI HEADS-REGULAR COLLAR/WHITE

LC9223 23" Timpani Head.....	\$72.45B
LC9225 25" Timpani Head.....	75.60B
LC9226 26" Timpani Head.....	76.65B
LC9228 28" Timpani Head.....	80.85B
LC9229 29" Timpani Head.....	84.00B
LC9230 30" Timpani Head.....	89.25B
LC9232 32" Timpani Head.....	90.30B

## LUDWIG SPECIALTY HEADS-VINTAGE BASS DRUM HEAD (with Script Logo)

LW4220V 20" Vintage Bass Drum Head.....	\$66.15B
LW4222V 22" Vintage Bass Drum Head.....	70.35B

## LUDWIG SPECIALTY HEADS-SNARE (CLEAR)

LC1113 13" Resonant Snare (X-Thin).....	\$22.50B
LC1114 14" Resonant Snare (X-Thin).....	27.30B
LC1115 15" Resonant Snare (X-Thin).....	29.40B
LW6112 12" Rocker w/ Silver Dot.....	25.20B
LW6114 14" Rocker w/Silver Dot.....	29.40B
LW4314 14" Ensemble, Heavy.....	29.40B

www.ludwig-drums.com

# EVANS

## Snare & Tom-Tom

### J1 Etched

J for "Jazz." These 10mil single-ply heads have an etched finish that's ideal for brushes, but doesn't chip away under sticks. With maximized sustain and frequency balance, the J1 emits a natural earthiness similar to calf – but without the problems.

<b>E06J1</b> 6" Batter.....	\$25.00	<b>E13J1</b> 13" Batter.....	\$31.25
<b>E08J1</b> 8" Batter.....	25.00	<b>E14J1</b> 14" Batter.....	33.25
<b>E10J1</b> 10" Batter.....	28.00	<b>E15J1</b> 15" Batter.....	35.25
<b>E12J1</b> 12" Batter.....	29.00	<b>E16J1</b> 16" Batter.....	37.50

## Genera G1

The single-ply industry standard, G1s blend warmth, sustain, and articulation. The high performance 10mil film ensures that the G1 is both durable and expressive.

Coated		Clear	
<b>B06G1</b> 6" Batter.....	\$23.25	<b>TT06G1</b> 6" Batter.....	\$23.25
<b>B08G1</b> 8" Batter.....	24.25	<b>TT08G1</b> 8" Batter.....	24.25
<b>B10G1</b> 10" Batter.....	25.25	<b>TT10G1</b> 10" Batter.....	25.25
<b>B12G1</b> 12" Batter.....	26.25	<b>TT12G1</b> 12" Batter.....	26.25
<b>B13G1</b> 13" Batter.....	28.25	<b>TT13G1</b> 13" Batter.....	28.25
<b>B14G1</b> 14" Batter.....	29.50	<b>TT14G1</b> 14" Batter.....	29.50
<b>B15G1</b> 15" Batter.....	32.50	<b>TT15G1</b> 15" Batter.....	32.50
<b>B16G1</b> 16" Batter.....	33.50	<b>TT16G1</b> 16" Batter.....	33.50
<b>B18G1</b> 18" Batter.....	43.50	<b>TT18G1</b> 18" Batter.....	43.50
<b>B20G1</b> 20" Batter.....	49.00	<b>TT20G1</b> 20" Batter.....	49.00

## Genera G2

A two-ply head (7mil each) featuring extraordinary consistency.

Coated		Clear	
<b>B06G2</b> 6" Batter.....	\$23.25	<b>TT06G2</b> 6" Batter.....	\$23.25
<b>B08G2</b> 8" Batter.....	24.25	<b>TT08G2</b> 8" Batter.....	24.25
<b>B10G2</b> 10" Batter.....	25.25	<b>TT10G2</b> 10" Batter.....	25.25
<b>B12G2</b> 12" Batter.....	26.25	<b>TT12G2</b> 12" Batter.....	26.25
<b>B13G2</b> 13" Batter.....	28.25	<b>TT13G2</b> 13" Batter.....	28.25
<b>B14G2</b> 14" Batter.....	29.50	<b>TT14G2</b> 14" Batter.....	29.50
<b>B15G2</b> 15" Batter.....	32.50	<b>TT15G2</b> 15" Batter.....	32.50
<b>B16G2</b> 16" Batter.....	33.50	<b>TT16G2</b> 16" Batter.....	33.50
<b>B18G2</b> 18" Batter.....	43.50	<b>TT18G2</b> 18" Batter.....	43.50
<b>B20G2</b> 20" Batter.....	49.00		

## Resonant Tom Heads

### Genera Resonant

Genera Resonants have very bright overtones. When used with 1- or 2-ply clear or coated batter heads, they will provide a bright, open sustain.

<b>TT06GR</b> 6" Resonant...	\$23.25	<b>TT14GR</b> 14" Resonant...	\$29.50
<b>TT08GR</b> 8" Resonant.....	24.25	<b>TT15GR</b> 15" Resonant.....	31.50
<b>TT10GR</b> 10" Resonant.....	25.25	<b>TT16GR</b> 16" Resonant.....	33.50
<b>TT12GR</b> 12" Resonant.....	26.25	<b>TT18GR</b> 18" Resonant.....	42.50
<b>TT13GR</b> 13" Resonant.....	28.25		

### Resonant Glass and Black

Resonant Glass and Black heads are the thinnest resonant heads we make. Thickness: Glass: 6.5 mil; Black 7 mil

### Resonant Black

<b>TT08RBG</b> 8" Resonant...	\$28.25	<b>TT14RBG</b> 14" Resonant...	\$34.50
<b>TT10RBG</b> 10" Resonant.....	29.50	<b>TT16RBG</b> 16" Resonant.....	38.75
<b>TT12RBG</b> 12" Resonant.....	30.50	<b>TT18RBG</b> 18" Resonant.....	48.25
<b>TT13RBG</b> 13" Resonant.....	32.50		

### Resonant Glass

<b>TT08RGL</b> 8".....	\$24.25	<b>TT14RGL</b> 14".....	\$29.50
<b>TT10RGL</b> 10".....	25.25	<b>TT15RGL</b> 15".....	31.50
<b>TT12RGL</b> 12".....	26.25	<b>TT16RGL</b> 16".....	33.50
<b>TT13RGL</b> 13".....	28.25	<b>TT18RGL</b> 18".....	42.50

## Hydraulic

A classic sound, short in sustain. Tension it tight for a real thump or loose and slappy. Two plies sandwich a thin film of oil that suppresses unwanted overtones.



### Evans Hydraulic Glass

<b>TT06HG</b> 6" Batter.....	\$25.00
<b>TT08HG</b> 8" Batter.....	26.00
<b>TT10HG</b> 10" Batter.....	27.00
<b>TT12HG</b> 12" Batter.....	28.00
<b>TT13HG</b> 13" Batter.....	30.00
<b>TT14HG</b> 14" Batter.....	32.00
<b>TT15HG</b> 15" Batter.....	34.00
<b>TT16HG</b> 16" Batter.....	36.00
<b>TT18HG</b> 18" Batter.....	43.50
<b>TT20HG</b> 20" Batter.....	51.50

### Evans Hydraulic Black

<b>TT06HBG</b> 6" Batter.....	\$27.00
<b>TT08HBG</b> 8" Batter.....	28.00
<b>TT10HBG</b> 10" Batter.....	29.00
<b>TT12HBG</b> 12" Batter.....	31.00
<b>TT13HBG</b> 13" Batter.....	33.00
<b>TT14HBG</b> 14" Batter.....	35.00
<b>TT15HBG</b> 15" Batter.....	37.00
<b>TT16HBG</b> 16" Batter.....	39.00
<b>TT18HBG</b> 18" Batter.....	46.50
<b>TT20HBG</b> 20" Batter.....	55.00

### Evans Hydraulic Blue

<b>TT06HB</b> 6" Batter.....	\$25.00
<b>TT08HB</b> 8" Batter.....	26.00
<b>TT10HB</b> 10" Batter.....	27.00
<b>TT12HB</b> 12" Batter.....	28.00
<b>TT13HB</b> 13" Batter.....	30.00
<b>TT14HB</b> 14" Batter.....	32.00
<b>TT15HB</b> 15" Batter.....	34.00
<b>TT16HB</b> 16" Batter.....	36.00
<b>TT18HB</b> 18" Batter.....	43.50
<b>TT20HB</b> 20" Batter.....	51.50

### Evans Hydraulic Snare Ctd. Blue

<b>B14HB</b> 14" Batter.....	\$35.00
------------------------------	---------

### Evans Hydraulic Snare Ctd. Black

<b>B14HBG</b> 14" Batter.....	\$35.00
-------------------------------	---------

## Heavyweight Snare Batter Heads

The Heavyweight snare batter head is the thickest, most durable film-based drumhead in the Evans product line. Designed with the "heavy hitter" in mind, the Heavyweight is 23mil thick at the center of the head. While thicker heads often "choke out" due to extreme mass, the Heavyweight reverse dot patch flexes and allows for a wider dynamic range.

<b>B12HW</b> 12" Heavyweight Snare Batter.....	\$34.25
<b>B13HW</b> 13" Heavyweight Snare Batter.....	36.50
<b>B14HW</b> 14" Heavyweight Snare Batter.....	38.50

## ST™ (Super Tough) and ST™ Dry

Packing two layers of 7.5mil film, the ST promotes durability and a full-bandwidth rim shot. It delivers all the volume and ring needed, yet amazingly responds to the flick of a fingernail. On the "Dry" version, small vent holes around the edge eliminate stray harmonics and tighten the sound.

<b>ST</b>	
<b>B13ST</b> 13".....	\$32.50
<b>B14ST</b> 14".....	34.50
<b>ST Dry</b>	
<b>B13STD</b> 13".....	\$32.50
<b>B14STD</b> 14".....	34.50

## Snare Size Hazy 300

The Hazy 300 is Evans' most versatile snare side head. The 3mil film yields a wide dynamic range and controlled snare response at all dynamic levels.

<b>S10H30</b> 10".....	\$23.25
<b>S12H30</b> 12".....	25.25
<b>S13H30</b> 13".....	25.25
<b>S14H30</b> 14".....	27.25
<b>S15H30</b> 15".....	29.75

# EVANS

## Snare POWER CENTER®

The 10mil single-ply Power Center offers durability and focus in the center via a 5mil patch. Unique slots in the 5" diameter dot allow it to flex, keeping the head open at the edges. The Reverse Dot head moves the dot to the underside, and out of the way for brushes.



<b>Evans Power Center®</b>	<b>Evans Power Center® Reverse Dot</b>
<b>B13G1D</b> 13" Batter..... \$31.25	<b>B13G1RD</b> 13" Batter..... \$31.25
<b>B14G1D</b> 14" Batter..... 34.50	<b>B14G1RD</b> 14" Batter .....34.50

## Snare GENERA

The best of both worlds, the GENERA is a single-ply head that has the fat spread of a double-ply head. A slender 2 mil overtone control ring on the underside "floats" with the head, affording a touch of damping. The rimshot remains clear.



<b>B13GEN</b> 13" Batter ..... \$31.25
<b>B14GEN</b> 14" Batter ..... 33.25

## Snare GENERA DRY

A step dryer in a one-ply head. Evans tried-and-true vents eliminate stray harmonics - and permit the head to "give" a little under your stick. Tuned medium/loose and struck dead center, the head responds with a snare sizzle that's microphone friendly. Tighten it and the GENERA DRY opens up with a crisp rimshot.



<b>B12DRY</b> 12" Batter ..... \$29.00
<b>B13DRY</b> 13" Batter ..... 31.25
<b>B14DRY</b> 14" Batter ..... 33.25

## Snare GENERA HD

It yields an extremely full rimshot and balanced response from the center. Lay into this one with the assurance that it's not going to go anywhere! The muffling is just a tad and banishes only troublesome overtones. Tighten the GENERA HD; it will not choke. It barks live - plus, it speaks within an ideal frequency window for studio.



<b>B12HD</b> 12" Batter ..... \$30.50
<b>B13HD</b> 13" Batter ..... 32.50
<b>B14HD</b> 14" Batter ..... 34.50

## Snare GENERA HD DRY

<b>B12HDD</b> 12" Batter..... \$30.50	<b>B14HDD</b> 14" Batter ..... \$34.50
<b>B13HDD</b> 13" Batter..... 32.50	

## Snare Side Hazy 200, Glass 500

The 2 mil Hazy 200 snare side will enhance sensitivity for softer dynamics and brushwork. The 5mil Glass 500 snare side produces a dark, throaty sound.

<b>S10H20</b> 10"..... \$23.25	
<b>S12H20</b> 12"..... 25.25	
<b>S13H20</b> 13"..... 25.25	<b>S13R50</b> .....\$25.25
<b>S14H20</b> 14"..... 27.25	<b>S14R50</b> .....27.25

## Evans G-14 Series

Evans G-14 series of drumheads features a single ply of 14mil film that delivers unprecedented durability, combined with the dynamic response of a single-ply drumhead. Ideal for use in high-volume performance situations, the G14 can withstand relatively heavy playing while projecting through the mix to provide a full, aggressive sound.

Clear		Coated White	
<b>TT06G14</b> 6".....	\$23.25	<b>B06G14</b> 6".....	\$23.25
<b>TT08G14</b> 8".....	24.25	<b>B08G14</b> 8".....	24.25
<b>TT10G14</b> 10".....	25.25	<b>B10G14</b> 10".....	25.25
<b>TT12G14</b> 12".....	26.25	<b>B12G14</b> 12".....	26.25
<b>TT13G14</b> 13".....	28.25	<b>B13G14</b> 13".....	28.25
<b>TT14G14</b> 14".....	29.50	<b>B14G14</b> 14".....	29.50
<b>TT15G14</b> 15".....	32.50	<b>B15G14</b> 15".....	32.50
<b>TT16G14</b> 16".....	33.50	<b>B16G14</b> 16".....	33.50
<b>TT18G14</b> 18".....	43.50	<b>B18G14</b> 18".....	43.50
<b>TT20G14</b> 20".....	49.00	<b>B20G14</b> 20".....	49.00

## Tompaks & Bulk Snare

<b>ETPG14CLRR</b> .....\$76.25	<b>ETPG14CTDR</b> .....\$76.25
<b>ETPG14CLRS</b> .....78.25	<b>ETPG14CTDS</b> .....78.25
<b>ETPG14CLRF</b> .....73.00	<b>ETPG14CTDF</b> .....73.00

## EC™ (Edge Control)\*

The new and improved EC2 tom heads feature Sound Shaping Technology™, a new damping technique that insures optimized performance for each individually sized drumhead. Made using 2-ply of 7mil film, the new design increases attack, tone, length of sustain, and ease of tuning for each size head...delivering a more balanced and pre-EQ'd sound across the full kit. \*US Patent #7,214,867

Clear		Coated	
<b>TT06EC2S</b> 6".....	\$27.25	<b>B06EC2S</b> 6".....	\$27.25
<b>TT08EC2S</b> 8".....	28.25	<b>B08EC2S</b> 8".....	28.25
<b>TT10EC2S</b> 10".....	29.50	<b>B10EC2S</b> 10".....	29.50
<b>TT12EC2S</b> 12".....	30.50	<b>B12EC2S</b> 12".....	30.50
<b>TT13EC2S</b> 13".....	32.50	<b>B13EC2S</b> 13".....	32.50
<b>TT14EC2S</b> 14".....	34.50	<b>B14EC2S</b> 14".....	34.50
<b>TT15EC2S</b> 15".....	38.50	<b>B15EC2S</b> 15".....	37.75
<b>TT16EC2S</b> 16".....	38.75	<b>B16EC2S</b> 16".....	38.75
<b>TT18EC2S</b> 18".....	48.00	<b>B18EC2S</b> 18".....	48.00

## Black Chrome™

Evans Black Chrome batter heads feature a two-ply construction with a top ply of 7mil optically clear film over a 7.5mil black film to create a black mirror-like aesthetic. The opposing film combination provides a robust tone with accentuated mid-to-low frequency response. Evans Black Chrome is idea for progressive rock/metal drummers looking for a deep sound with an articulate attack and reliable durability.

<b>TT06CHR</b> 6".....\$30.25	<b>TT14CHR</b> 14".....\$38.40
<b>TT08CHR</b> 8".....31.25	<b>TT15CHR</b> 15".....42.75
<b>TT10CHR</b> 10".....32.25	<b>TT16CHR</b> 16".....43.75
<b>TT12CHR</b> 12".....34.25	<b>TT18CHR</b> 18".....57.25
<b>TT13CHR</b> 13".....36.50	<b>TT20CHR</b> 20".....65.00

## EC™ Resonant (Edge Control)

The EC Resonant has the ability to control and correct tuning inconsistencies while offering a more centered pitch, increased resonance and dynamic range, and enhanced projection. Made with a 10mil ultra-clear film that provides a mid-range frequency bump, the EC Resonant highlights the natural sound of the drum.

<b>TT08ECR</b> 8"..... \$28.25	<b>TT14ECR</b> 14"..... \$34.50
<b>TT10ECR</b> 10"..... 29.50	<b>TT15ECR</b> 15"..... 37.50
<b>TT12ECR</b> 12"..... 30.50	<b>TT16ECR</b> 16"..... 38.75
<b>TT13ECR</b> 13"..... 32.50	<b>TT18ECR</b> 18"..... 46.75

# EVANS



## Onyx™ Series

The Onyx tom head are designed with two piles of 7.5mil film that will deliver enhanced durability while making the drums cut live. A micro-clear coating gives the Onyx heads a matte black appearance and produces more low-end and a punchier attack. The Onyx tom heads are pitch black and rock solid.

<b>B06ONX2</b>	6" .....	\$29.00	<b>B14ONX2</b>	14" .....	\$38.50
<b>B08ONX2</b>	8" .....	31.25	<b>B15ONX2</b>	15" .....	42.75
<b>B10ONX2</b>	10" .....	32.25	<b>B16ONX2</b>	16" .....	43.75
<b>B12ONX2</b>	12" .....	34.25	<b>B18ONX2</b>	18" .....	58.25
<b>B13ONX2</b>	13" .....	36.50	<b>B20ONX2</b>	20" .....	64.00



## EC Snare™ Batter

"Edge Control" technology that pre-EQs the sound, removing troublesome mid-range overtones. The addition of a specially designed patch on the Reverse Dot models lends extra durability, focus, and attack in the center.

### EC1 Reverse Dot (1-ply)

<b>B13EC1RD</b>	13" .....	\$34.25
<b>B14EC1RD</b>	14" .....	36.25

### EC Reverse Dot (2-ply)

<b>EC (2-ply)</b>		
<b>B10ECS</b>	10" .....	\$31.50
<b>B14ECS</b>	14" .....	37.75
<b>B10ECSR</b>	10" .....	\$29.00
<b>B12ECSR</b>	12" .....	34.25
<b>B13ECSR</b>	13" .....	36.50
<b>B14ECSR</b>	14" .....	38.50



## Power Center™

The 10mil single-ply Power Center offers durability and focus in the center via a 5mil patch. Unique slots in the 5" diameter dot allow it to flex, keeping the head open at the edges. The Reverse Dot head moves the dot to the underside, and out of the way for brushes. \*US Patent #5,986,196

<b>Power Center</b>			<b>Power Center Reverse Dot</b>		
<b>B13G1D</b>	13" .....	\$31.25	<b>B10G1RD</b>	10" .....	\$28.00
<b>B14G1D</b>	14" .....	34.50	<b>B12G1RD</b>	12" .....	29.00
			<b>B13G1RD</b>	13" .....	31.25
			<b>B14G1RD</b>	14" .....	34.50

### Power Center™ Bulk

<b>B14G1D-B</b>	14" Power Center/Bulk Pack (10) .....	\$345.10
<b>B14G1RD-B</b>	14" Power Center Reverse Dot/Bulk Pack (10) .....	345.10



## Hybrid™ Coated

By utilizing two unique high-tensile fibers, one chosen for flexibility and the other for durability, the Hybrid snare batter achieves greater snare response and dynamic range, while maintaining the extreme durability and accentuated attack preferred by the hardest hitters.

<b>B13MHG</b>	13" .....	\$107.00
<b>B14MHG</b>	14" .....	116.00



## Onyx™ Resonant Bass Heads

Like the toms and snare the Onyx front bass drum head has a micro-clear coating to create a matte black look. Designed using the EQ3 Reso construction, it's a 7.5mil single-ply head with internal control ring and a 5" offset microphone port.

<b>BD18RONX</b>	18" .....	\$80.00
<b>BD20RONX</b>	20" .....	84.75
<b>BD22RONX</b>	22" .....	90.75
<b>BD24RONX</b>	24" .....	101.25
<b>BD26RONX</b>	26" .....	111.50



## GMAD Bass Heads

The GMAD is a synthesis of the EMAD and G Plus concepts. By utilizing the same exclusive 12mil film used to produce the award winning G Plus, the GMAD has greater punch, depth, and durability relative to the original. It is ideal for heavier hitters looking for a solid sound and more life to the head but prefer the feel of a single-ply. Like the original EMAD, the GMAD features an

improved version of Evans' patented EMAD, Externally Mounted Adjustable Damping system. A black plastic sleeve holds the player's choice of two foam dampening rings of different widths that control attack, low-end, and sustain.

<b>BD18GMAD</b>	18" .....	\$83.50
<b>BD20GMAD</b>	20" .....	87.50
<b>BD22GMAD</b>	22" .....	91.75
<b>BD24GMAD</b>	24" .....	97.00
<b>BD26GMAD</b>	26" .....	105.25

## EMAD Onyx Bass Batter

The EMAD Onyx utilizes a single ply of 10mil black film with an improved EMAD damping ring and a micro-clear coated that produces an extra dark sound while delivering additional punch. It's the perfect aesthetic and sonic compliment to the Onyx tom heads and Onyx bass resonant.

<b>BD22EMADON</b>	22" .....	\$96.25
-------------------	-----------	---------



## G12™

Evans™ G12™ series features a single ply of 12mil film, offering single-ply feel with two-ply durability. The 20 percent thicker film also provides a deeper fundamental tone and enhanced projection versus traditional 10mil heads. The coated version delivers additional warmth, focus.

<b>CLEAR</b>			<b>COATED</b>		
<b>TT06G12</b>	6" .....	\$23.25	<b>B06G12</b>	6" .....	\$23.25
<b>TT08G12</b>	8" .....	24.25	<b>B08G12</b>	8" .....	24.25
<b>TT10G12</b>	10" .....	25.25	<b>B10G12</b>	10" .....	25.25
<b>TT12G12</b>	12" .....	26.25	<b>B12G12</b>	12" .....	26.25
<b>TT13G12</b>	13" .....	28.25	<b>B13G12</b>	13" .....	28.25
<b>TT14G12</b>	14" .....	29.50	<b>B14G12</b>	14" .....	29.50
<b>TT15G12</b>	15" .....	32.50	<b>B15G12</b>	15" .....	32.50
<b>TT16G12</b>	16" .....	33.50	<b>B16G12</b>	16" .....	33.50
<b>TT18G12</b>	18" .....	43.50	<b>B18G12</b>	18" .....	43.50
<b>TT20G12</b>	20" .....	49.00	<b>B20G12</b>	20" .....	49.00

## EMAD Bass Resonant Head

A 7 mil head with a fixed interal ring, the EMAD Resonant features two interchangeable foam rings that damp overtones around the edge of the 4" offset port, focusing the pitch and enhancing attack. The port is positioned for easy microphone placement.

### Black

<b>BD18REMAD</b>	18" .....	\$85.25
<b>BD20REMAD</b>	20" .....	89.50
<b>BD22REMAD</b>	22" .....	95.75
<b>BD24REMAD</b>	24" .....	102.00
<b>BD26REMAD</b>	26" .....	110.25



## EMAD Clear Bass Batter Head

Tailor degrees of damping and attack without removing the head or reaching inside the drum. The EMAD is a 10mil single-ply with two interchangeable damping rings that maximize attack and low-end. The coating adds additional warmth, focus, and depth.

<b>BD18EMAD</b>	18" 1 Ply.....	\$83.25	<b>BD18EMAD2</b>	18" 2 Ply.....	\$83.50
<b>BD20EMAD</b>	20" 1 Ply.....	87.25	<b>BD20EMAD2</b>	20" 2 Ply.....	87.50
<b>BD22EMAD</b>	22" 1 Ply.....	91.75	<b>BD22EMAD2</b>	22" 2 Ply.....	91.75
<b>BD24EMAD</b>	24" 1 Ply.....	97.00	<b>BD24EMAD2</b>	24" 2 Ply.....	97.00
<b>BD26EMAD</b>	26" 1 Ply.....	105.25	<b>BD26EMAD2</b>	26" 2 Ply.....	105.00

## EMAD Coated Bass Batter Head

<b>BD18EMADCW</b>	18" EMAD Coated Batter .....	\$83.50
<b>BD20EMADCW</b>	20" EMAD Coated Batter .....	87.50
<b>BD22EMADCW</b>	22" EMAD Coated Batter.....	91.75
<b>BD24EMADCW</b>	24" EMAD Coated Batter .....	97.00
<b>BD26EMADCW</b>	26" EMAD Coated Batter.....	105.25

## EMAD Heavyweight Bass Batter Head

The EMAD Heavyweight bass batter head redefines the sonic capabilities of the acoustic bass drum. Combining two plies of identical 10mil film with the groundbreaking EMAD system, the EMAD Heavyweight is the thickest, most durable bass head in the Evans product line. With the EMAD system, additional muffling isn't necessary. Two different muffling rings are provided in order to adjust sustain and tonal focus.

<b>BD18EMADHW</b>	18" EMAD Heavyweight Bass Drum Head.....	\$83.50
<b>BD20EMADHW</b>	20" EMAD Heavyweight Bass Drum Head.....	87.50
<b>BD22EMADHW</b>	22" EMAD Heavyweight Bass Drum Head.....	91.75
<b>BD24EMADHW</b>	24" EMAD Heavyweight Bass Drum Head.....	97.00
<b>BD26EMADHW</b>	26" EMAD Heavyweight Bass Drum Head.....	105.25

## EQ Bass Drumheads

This single-ply head with an internal overtone control ring, a removable muffle ring, and dry-vents provides a definitive, out-of-the-box mix of punch and tone. It can thump for rock or sing for jazz. The frosted version gives a little extra warmth and punch.

<b>BD18GB1</b>	18" EQ1 Clear.....	\$83.75	<b>BD24GB1</b>	24" EQ1 Clear.....	\$100.00
<b>BD20GB1</b>	20" EQ1 Clear.....	88.25	<b>BD26GB1</b>	26" EQ1 Clear.....	106.25

## EQ2 Clear Bass Batter Heads

An extra-durable two-ply head with an internal overtone control ring, a removable muffle ring and dry-vents, the EQ2 gives the microphone what it wants to hear, yet can project controlled spread without mics.

<b>BD18GB2</b>	18" EQ2 Clear.....	\$83.50	<b>BD24GB2</b>	24" EQ2 Clear.....	\$104.00
<b>BD20GB2</b>	20" EQ2 Clear.....	88.50	<b>BD26GB2</b>	26" EQ2 Clear.....	110.25
<b>BD22GB2</b>	22" EQ2 Clear.....	95.75			

## EQ3 Bass Batter Heads

The two-ply EQ3 with an internal overtone control ring and removable muffle ring puts the kick back in kick drum. Controlled low-end rumble and focused attack make it the perfect live head. Due to its two plies, it will not distort under heavy hitting. The coated version lends a little warmth.

<b>BD18GB3</b>	18" EQ3 Clear.....	\$83.75
<b>BD20GB3</b>	20" EQ3 Clear.....	88.50
<b>BD22GB3</b>	22" EQ3 Clear.....	95.75
<b>BD24GB3</b>	24" EQ3 Clear.....	104.00
<b>BD26GB3</b>	26" EQ3 Clear.....	110.25

## EQ3 Bass Batter Heads

<b>BD18GB3C</b>	18" EQ3 Coated.....	\$83.75
<b>BD20GB3C</b>	20" EQ3 Coated.....	88.50
<b>BD22GB3C</b>	22" EQ3 Coated.....	95.75
<b>BD24GB3C</b>	24" EQ3 Coated.....	104.00
<b>BD26GB3C</b>	26" EQ3 Coated.....	110.25

## EQ4 Bass Batter Heads

Provides optimum slap without sacrificing bottom end. You kick the EQ4 and it kicks back! A special film makes this 10mil single-ply extra rugged and the width of the fixed internal ring is proportional to the head size, optimizing control from 18" to 26".

<b>BD18GB4</b>	18" EQ4 Clear.....	\$63.50
<b>BD20GB4</b>	20" EQ4 Clear.....	67.50
<b>BD22GB4</b>	22" EQ4 Clear.....	72.75
<b>BD24GB4</b>	24" EQ4 Clear.....	78.00
<b>BD26GB4</b>	26" EQ4 Clear.....	84.75

## EQ4 Bass Batter Heads

<b>BD18GB4C</b>	18" EQ4 Coated.....	\$63.50
<b>BD20GB4C</b>	20" EQ4 Coated.....	67.50
<b>BD22GB4C</b>	22" EQ4 Coated.....	72.75



## EQ1 Resonant Bass Heads

This solid resonant head with an internal overtone control ring and dry-vents produces a cavernous rumble that is microphone-friendly. It also responds with a clean fundamental and a controlled, but full, sustain when tuned high for jazz and pop.

<b>BD18RA</b>	18" EQ1 Resonant Black.....	\$75.00
<b>BD20RA</b>	20" EQ1 Resonant Black.....	80.00
<b>BD22RA</b>	22" EQ1 Resonant Black.....	86.75
<b>BD24RA</b>	24" EQ1 Resonant Black.....	93.00
<b>BD26RA</b>	26" EQ1 Resonant Black.....	102.00

# EVANS

## Marching EC2S

The Marching EC2™ features two matching piles of 7 mil film for greater strength and durability. Sound Shaping Technology (SST™) controls overtones for focused sound. The hoop profile is specially designed to withstand higher tensions and offer greater durability.

<b>TT06MEC2S</b>	6" Marching EC2S Tenor.....	\$28.25
<b>TT08MEC2S</b>	8" Marching EC2S Tenor.....	29.50
<b>TT10MEC2S</b>	10" Marching EC2S Tenor.....	30.50
<b>TT12MEC2S</b>	12" Marching EC2S Tenor.....	32.50
<b>TT13MEC2S</b>	13" Marching EC2S Tenor.....	34.50
<b>TT14MEC2S</b>	14" Marching EC2S Tenor.....	36.75

## Control Screens for Marching Snare Drums

Evans Control Screen is designed for marching snare drums, the Evans Control Screen offers a simple and effective way to reduce overall volume without sacrificing tone, articulation, or feel. Fitting neatly underneath the drumhead, the Evans Control Screen is simple to install and remove as needed.

<b>EMA13CS1</b>	13" Control Screen.....	\$22.50
<b>EMA14CS1</b>	14" Control Screen.....	22.50

## EQ3 Resonant Black Heads

CONFIGURATION: Black, internal overtone control ring, 5" offset hole

THICKNESS: Single ply: 7 mil; internal overtone control ring: 10 mil

<b>BD18RB</b>	18" EQ3 Resonant Black.....	\$75.00
<b>BD20RB</b>	20" EQ3 Resonant Black.....	80.00
<b>BD22RB</b>	22" EQ3 Resonant Black.....	86.75
<b>BD24RB</b>	24" EQ3 Resonant Black.....	\$96.75
<b>BD26RB</b>	26" EQ3 Resonant Black.....	102.00

## EQ3 Resonant Smooth White Heads

CONFIGURATION: Internal overtone control ring, 5" offset hole

THICKNESS: Single ply: 6.5 mil; internal overtone control ring: 10 mil

<b>BD20RSW</b>	20" EQ3 Resonant.....	\$77.00
<b>BD22RSW</b>	22" EQ3 Resonant.....	83.50
<b>BD24RSW</b>	24" EQ3 Resonant.....	93.00
<b>BD26RSW</b>	26" EQ3 Resonant.....	102.00

## EQ3 Resonant Coated White Heads

CONFIGURATION: Coated white, internal overtone control ring, 5" offset hole

THICKNESS: Single ply: 6.5 mil; internal overtone control ring: 10 mil

SOUND: Focused, controlled sound; RESONANCE: Short sustain

APPLICATION: General use, good for internal miking, live or studio

<b>BD18RGCW</b>	18" EQ3 Resonant Coated White.....	\$75.00
<b>BD20RGCW</b>	20" EQ3 Resonant Coated White.....	80.50
<b>BD22RGCW</b>	22" EQ3 Resonant Coated White.....	86.75
<b>BD26RGCW</b>	26" EQ3 Resonant Coated White.....	106.00

## Resonant

A 7mil single-ply with no rings or vents, the Resonant provides a wide-open tone with maximum sustain. It's ideal for jazz and bop.

### Resonant Black Bass Heads

<b>BD20RBG</b>	20".....	\$71.00
<b>BD22RBG</b>	22".....	76.25

## Hydraulic Bass Heads

A classic sound, short in sustain. Tension it tight for a real thump or loose and slappy. Two plies sandwich a thin film of oil that suppresses unwanted overtones.

<b>BD22HB</b>	22" Hydraulic Blue.....	\$72.75
<b>BD22HG</b>	22" Hydraulic Glass.....	72.75
<b>BD22HBC</b>	22" Hydraulic Black.....	98.75

## Genera G1 & G2 Bass Heads

A starting point in traditional bass drum sounds. The G1 is a 10mil single-ply head that provides bright attack, warm sustain, and a broad tuning range.

### Genera G1 Clear Bass Heads

<b>BD18G1</b>	18" G1 Clear.....	\$59.00
<b>BD20G1</b>	20" G1 Clear.....	63.50
<b>BD22G1</b>	22" G1 Clear.....	67.50

### Genera G1 Coated White Bass Heads

<b>BD18G1CW</b>	18" G1 Coated White.....	\$61.25
<b>BD20G1CW</b>	20" G1 Coated White.....	63.50
<b>BD22G1CW</b>	22" G1 Coated White.....	67.50

### Genera G2 Clear Bass Heads

The two 7mil plies of the G2 bass head offer maximum durability with wide-open response and undeniably fat low-end.

<b>BD20G2</b>	20" Genera G2 Clear.....	\$63.50
<b>BD22G2</b>	22" Genera G2 Clear.....	67.50



## Hybrid S Series Snare Batter

Hybrid S batter features two unique fibers that, when blended together, deliver a soft and sensitive feel with a warm, full, and tonally rich sound with superior snare response. (Black)

<b>SB13MHSB</b>	13".....	\$93.50
<b>SB14MHSB</b>	14".....	98.75



## Hybrid Series Snare Batter

By utilizing two unique high-tensile fibers, one chosen for flexibility and the other for durability, the Hybrid marching snare batter achieves a much softer feel, greater sensitivity, and a broader dynamic range while enhancing projection and durability.

### Grey Batter

<b>SB13MHG</b>	13".....	\$104.00
<b>SB14MHG</b>	14".....	112.25

### White Batter

<b>SB13MHW</b>	13".....	\$104.00
<b>SB14MHW</b>	14".....	112.25



## Hybrid Series Snare Side

By imbedding high-tensile fibers in an open weave pattern between two ultra-thin layers of clear film, the Hybrid marching snare side head produces the sound and sensitivity of a polyester bottom with a resistance to stretch that is closer to Kevlar™

<b>SS13MH1</b>	13".....	\$62.50
<b>SS14MH1</b>	14".....	66.50

## MS3™ Polyester Snare Side Head

MS3 clear Polyester snare side head delivers a dark, rich sound. A 2mil flap helps suppress unwanted overtones while providing reinforcement at the collar to increase longevity.

<b>SS13MS3C</b>	13".....	\$27.00
<b>SS14MS3C</b>	14".....	28.00

## MX5 Snare Side Head (5mil)

<b>SS13MX5</b>	13" MX5 Aramid Fiber Snare Side (5mil).....	\$88.50
<b>SS14MX5</b>	14" MX5 Aramid Fiber Snare Side (5mil).....	92.50



## MX™ Tenor Heads

The MX tenor heads are designed with an advanced hoop concept that prevents pull-out.

### White

TT06MXW	6"	.....	\$28.25
TT08MXW	8"	.....	29.50
TT10MXW	10"	.....	30.50
TT12MXW	12"	.....	32.50
TT13MXW	13"	.....	34.50
TT14MXW	14"	.....	36.75

### Frosted

TT06MXF	6"	.....	\$28.25
TT08MXF	8"	.....	29.50
TT10MXF	10"	.....	30.50
TT12MXF	12"	.....	32.50
TT13MXF	13"	.....	34.50
TT14MXF	14"	.....	36.75



## MX™ Black Tenor Head

The MX tenor heads are designed with an advanced hoop concept that prevents pull-out, and are made using two 7mil plies of black film that provide a dark contemporary look with a bright attack and an open tone that projects well.

TT06MXB	6"	.....	\$28.25
TT08MXB	8"	.....	29.50
TT10MXB	10"	.....	30.50
TT12MXB	12"	.....	32.50
TT13MXB	13"	.....	34.50
TT14MXB	14"	.....	36.75

## MX™ Black Bass Heads

### MX1 (1-ply) Black

BD16MX1B	16"	.....	\$93.50
BD18MX1B	18"	.....	99.75
BD20MX1B	20"	.....	106.00
BD22MX1B	22"	.....	114.50
BD24MX1B	24"	.....	122.75
BD26MX1B	26"	.....	131.00
BD28MX1B	28"	.....	143.50
BD30MX1B	30"	.....	158.00
BD32MX1B	32"	.....	172.75

### MX2 (2-ply) Black

BD16MX2B	16"	.....	\$93.50
BD18MX2B	18"	.....	99.75
BD20MX2B	20"	.....	106.00
BD22MX2B	22"	.....	114.50
BD24MX2B	24"	.....	122.75
BD26MX2B	26"	.....	131.00
BD28MX2B	28"	.....	143.50
BD30MX2B	30"	.....	158.00
BD32MX2B	32"	.....	166.00

## MX™ White Bass Head

The 10mil single-ply MX1 Marching Bass head is equipped with a unique tone-damping system that enhances articulation and focuses low-end. A series of felt damping arcs can be manipulated for indoor or outdoor marching. The MX2 utilizes the same tone-damping system as the MX1, but features 2 plies of 7.5 mil white film for enhanced durability, attack, focus & projection. It's ideal for indoor use.

### MX1 (1 ply)

BD16MX1W	16"	.....	\$83.25
BD18MX1W	18"	.....	89.50
BD20MX1W	20"	.....	95.75
BD22MX1W	22"	.....	104.00
BD24MX1W	24"	.....	112.75
BD26MX1W	26"	.....	120.75
BD28MX1W	28"	.....	133.00
BD30MX1W	30"	.....	147.75
BD32MX1W	32"	.....	162.25

### MX2 (2 ply)

BD16MX2W	16"	.....	\$83.25
BD18MX2W	18"	.....	89.50
BD20MX2W	20"	.....	95.75
BD22MX2W	22"	.....	104.00
BD24MX2W	24"	.....	112.75
BD26MX2W	26"	.....	120.75
BD28MX2W	28"	.....	133.00
BD30MX2W	30"	.....	147.75
BD32MX2W	32"	.....	162.25

## Marching Supreme (MS)

### MS3 Snare Side Head (3mil)

As an alternative to the MX Snare Side, Evans MS polyester snare side provides a wide dynamic range of possibilities. A 2mil polyester flap helps reinforce the material and controls overtones. The result is a rich, focused snare response. A unique 1/2" collar design provides longer life and greater tunability.

CONFIGURATION: Clear Polyester Film

THICKNESS: Single-ply: 2mil overtone control ring

SOUND: Focused response, wide dynamic range, extremely sensitive

RESONANCE: Rich, warm

APPLICATION: For Drum Corps/Marching Band/Pipe Band outdoor and indoor competition

SS13MS3C	13"	MS3 Polyester Snare Side.....	\$27.00
SS14MS3C	14"	MS3 Polyester Snare Side.....	28.00



### MS1 Bass Head (White)

You decide! This traditional-sounding, smooth white, 10mil single-ply head, gives discerning drummers the option to customize their sound with the damping system of their choice. These heads will project warm, musical tones indoors and outdoors.

CONFIGURATION: Smooth White

THICKNESS: Single-ply: 10mil

SOUND: Open, warm, traditional sound, great projection

RESONANCE: Warm sustain

APPLICATION: For Drum Corps/Marching Band outdoor and indoor competition

BD16MS1W	16"	MS1 Bass Head (White).....	\$64.50
BD18MS1W	18"	MS1 Bass Head (White).....	65.00
BD20MS1W	20"	MS1 Bass Head (White).....	71.75
BD22MS1W	22"	MS1 Bass Head (White).....	79.00
BD24MS1W	24"	MS1 Bass Head (White).....	87.25
BD26MS1W	26"	MS1 Bass Head (White).....	95.75
BD28MS1W	28"	MS1 Bass Head (White).....	106.00
BD30MS1W	30"	MS1 Bass Head (White).....	116.50
BD32MS1W	32"	MS1 Bass Head (White).....	122.00



### Corps Clear™ Tenor Heads

The 2-ply design with 6.5mil top-ply and 10mil bottom-ply not only delivers clarity of tone over the drum but enables the drums to cut through the ensemble in clear and discernible pitches to reach out front and into the stands.



TT06CC	6"	.....	\$25.00
TT08CC	8"	.....	26.00
TT10CC	10"	.....	27.00
TT12CC	12"	.....	29.00
TT13CC	13"	.....	31.25
TT14CC	14"	.....	33.25



## System Blue Tenor Heads

Designed in cooperation with the Blue Devil's percussion staff, the System Blue tenor head is a 2-ply design with 7mil top-ply and 7.5mil bottom.

TT06SB1	6"	.....	\$26.00
TT08SB1	8"	.....	27.00
TT10SB1	10"	.....	28.00
TT12SB1	12"	.....	\$30.00
TT13SB1	13"	.....	32.00
TT14SB1	14"	.....	34.00

## Concert Drumheads

### Orchestral Timpani Heads

To satisfy the most discerning orchestral percussionist, we settled on a pretensioned head. In fact, this head has a higher degree of pretension than any other synthetic head currently available. A black powder-coated steel insert ring delivers the desired effect when pedaled and affords additional support once the head is under tension. It will perform magnificently at *ppp* with soft mallets, yet will not break up or sound harsh at *fff*. It sustains when asked and mutes softly and quietly with the palm and fingers. Through all this, it retains definite pitch.



<b>ET20</b>	20" Timpani Head.....	\$152.00
<b>ET20625</b>	20 <sup>5</sup> / <sub>8</sub> " Timpani Head.....	152.00
<b>ET21</b>	21" Timpani Head.....	152.00
<b>ET22</b>	22" Timpani Head.....	162.25
<b>ET2250</b>	22 <sup>1</sup> / <sub>2</sub> " Timpani Head.....	162.25
<b>ET23</b>	23" Timpani Head.....	162.25
<b>ET2350</b>	23 <sup>1</sup> / <sub>2</sub> " Timpani Head.....	162.25
<b>ET24</b>	24" Timpani Head.....	162.25
<b>ET2425</b>	24 <sup>1</sup> / <sub>4</sub> " Timpani Head.....	162.25
<b>ET2450</b>	24 <sup>1</sup> / <sub>2</sub> " Timpani Head.....	167.50
<b>ET25</b>	25" Timpani Head.....	167.50
<b>ET2550</b>	25 <sup>1</sup> / <sub>2</sub> " Timpani Head.....	167.50
<b>ET26</b>	26" Timpani Head.....	167.50
<b>ET2650</b>	26 <sup>1</sup> / <sub>2</sub> " Timpani Head.....	172.75
<b>ET27</b>	27" Timpani Head.....	172.75
<b>ET2750</b>	27 <sup>1</sup> / <sub>2</sub> " Timpani Head.....	172.75
<b>ET2775</b>	27 <sup>3</sup> / <sub>4</sub> " Timpani Head.....	172.75
<b>ET28</b>	28" Timpani Head.....	172.75
<b>ET2850</b>	28 <sup>1</sup> / <sub>2</sub> " Timpani Head.....	177.75
<b>ET29</b>	29" Timpani Head.....	177.75
<b>ET30</b>	30" Timpani Head.....	177.75
<b>ET3050</b>	30 <sup>1</sup> / <sub>2</sub> " Timpani Head.....	177.75
<b>ET31</b>	31" Timpani Head.....	177.75
<b>ET3150</b>	31 <sup>1</sup> / <sub>2</sub> " Timpani Head.....	185.00
<b>ET32</b>	32" Timpani Head.....	185.00
<b>ET33</b>	33" Timpani Head.....	185.00
<b>ET3350</b>	33 <sup>1</sup> / <sub>2</sub> " Timpani Head.....	191.25
<b>ET34</b>	34" Timpani Head.....	191.25
<b>ET3450</b>	34 <sup>1</sup> / <sub>2</sub> " Timpani Head.....	191.25
<b>ET3475</b>	34 <sup>3</sup> / <sub>4</sub> " Timpani Head.....	200.75
<b>ET35</b>	35" Timpani Head.....	200.75
<b>ET36</b>	36" Timpani Head.....	200.75
<b>ET37</b>	37" Timpani Head.....	200.75

### Orchestral Snare Drumheads

The Genera Concert Snare is a thin, 7.5 mil head designed for symphonic playing. It has a warm, open sound and sensitive snare response, along with a wide dynamic range that covers everything from soft, defined, articulate playing to loud dynamic passages that cut through the orchestra (recommended snare side head is 200 weight). The Genera Concert Staccato Snare comes with an internal overtone control ring to increase articulation for delicate passages.

### Orchestral Snare

<b>B14GCS</b>	14" Orchestral Snare.....	\$29.50
<b>B14GCS</b>	14" Orchestral Staccato Snare.....	34.50

### Orchestral Resonant

#### Orchestral 200

<b>S14GEN20</b>	14" Resonant.....	27.25
-----------------	-------------------	-------

#### Orchestral 300

<b>S14GEN30</b>	14" Resonant.....	27.25
-----------------	-------------------	-------

### Strata™ Timpani Heads

Strata Timpani heads feature a smooth calf-colored coating perfected to prevent timpani mallet wear and enhance the sound of the head. Strata's warm tone, clarity pitch and articulation blend naturally with any ensemble. Strata Timpani heads are pre-tensioned with a black, powder-coated insert ring for tuning consistency and additional hoop support.

<b>EST20</b>	20".....	\$170.50	<b>EST28</b>	28".....	\$193.25
<b>EST20625</b>	20 <sup>5</sup> / <sub>8</sub> ".....	170.50	<b>EST2850</b>	28 <sup>1</sup> / <sub>2</sub> ".....	197.50
<b>EST21</b>	21".....	170.50	<b>EST29</b>	29".....	202.75
<b>EST22</b>	22".....	174.75	<b>EST30</b>	30".....	202.75
<b>EST2250</b>	22 <sup>1</sup> / <sub>2</sub> ".....	174.75	<b>EST3050</b>	30 <sup>1</sup> / <sub>2</sub> ".....	202.75
<b>EST23</b>	23".....	174.75	<b>EST31</b>	31".....	208.00
<b>EST2350</b>	23 <sup>1</sup> / <sub>2</sub> ".....	174.75	<b>EST3150</b>	31 <sup>1</sup> / <sub>2</sub> ".....	208.00
<b>EST24</b>	24".....	174.75	<b>EST32</b>	32".....	212.00
<b>EST2425</b>	24 <sup>1</sup> / <sub>2</sub> ".....	174.75	<b>EST33</b>	33".....	213.25
<b>EST2450</b>	24 <sup>1</sup> / <sub>2</sub> ".....	188.50	<b>EST3350</b>	33 <sup>1</sup> / <sub>2</sub> ".....	218.50
<b>EST25</b>	25".....	188.50	<b>EST34</b>	34".....	218.50
<b>EST2550</b>	25 <sup>1</sup> / <sub>2</sub> ".....	188.50	<b>EST3450</b>	34 <sup>1</sup> / <sub>2</sub> ".....	219.00
<b>EST26</b>	26".....	188.50	<b>EST3475</b>	34 <sup>3</sup> / <sub>4</sub> ".....	219.00
<b>EST2650</b>	26 <sup>1</sup> / <sub>2</sub> ".....	193.75	<b>EST35</b>	35".....	234.00
<b>EST27</b>	27".....	193.75	<b>EST36</b>	36".....	239.25
<b>EST2750</b>	27 <sup>1</sup> / <sub>2</sub> ".....	193.75	<b>EST37</b>	37".....	230.00
<b>EST2775</b>	27 <sup>3</sup> / <sub>4</sub> ".....	193.25			



# EVANS

## Timpani Head Reference Chart

When choosing Evans Timpani Heads, substitute a prefix within the blank space to denote the model: 'ET' – Evans Orchestral Timpani Head (opaque) 'EST' – Evans Strata™ Timpani Head (calf-colored)

Manufacturer	Bowl Inches	Size cm	Evans Item #	Manufacturer	Bowl Inches	Size cm	Evans Item #	Manufacturer	Bowl Inches	Size cm	Evans Item #
<b>Adams</b> (Philharmonic, Philharmonic Classic*)	20*	50.8*	23	<b>Hinger</b> (Dresden or Cable)	20	50.8	23	<b>Majestic</b> (Symphonic Grand, Symphonic, Harmonic Series)	20	50.8	22
	23*	58.4*	2550		22	55.9	25		23	58.4	25
	25	63.5	2750		23	58.4	26		26	66.0	28
	26*	66.0*	2850		25	63.5	28		29	73.7	31
	28	71.1	3050		28	71.1	31		32	81.3	34
	29*	73.7*	32		31	78.7	34	<b>New Yorker</b> (Dresden and Chain)	20	50.8	23
	30	76.2	33	32	81.3	3475	22		55.9	25	
	32*	81.3*	3475	<b>Jenco</b> (Dresden or Rotary)	23	58.4	2650		23	58.4	26
<b>Adams</b> (Symphonic, Professional, & Universal)	20	50.8	22		25	63.5	2750		24	60.9	27
	23	58.4	25		26	66.0	2750		25	63.5	28
	26	66.0	28		29	73.7	3050	26	66.0	29	
	29	73.7	31	30	76.2	33	27	68.6	30		
	32	81.3	34	<b>Kolberg</b>	22	55.9	2350	28	71.1	31	
	<b>Aehnel</b> (Munich & Dresden)	21.5	54.7		24	24	60.9	26	29	73.7	32
		22	55.9		25	26	66.0	28	30	76.2	33
		23	58.4		26	29	73.7	31	31	78.7	34
25		63.5	2775		31	78.7	33	<b>Ohio Timpani</b> *Formerly Clevelander	20	50.8	23
26		66.0	28	<b>Lefima</b> (Dresden)	22	55.9	25		24	60.9	26
26.5*		67.3*	2850		23	58.4	26		26	66.0	2850
28		71.1	31		25	63.5	27		29	73.7	3150
29		73.7	32		26	66.0	28		31	78.7	33
31	78.7	3350	26	66.0	2850	<b>Premier</b> (Pro Symphonic Concert Copper)	22.5	55.9	2350		
32	81.3	3450	28	71.1	31		25	63.5	26		
<b>American Drum</b> (Continental & Dresden)	19	48.2	22	30	76.2		33	28	71.1	29	
	20	50.8	23	<b>Lefima</b> (Voyager I & II)	22		55.9	2425	30	76.2	31
	21.5	54.7	24		25	63.5	2650	32	81.3	33	
	22	55.9	25		26	66.0	2775	<b>Premier</b> (Elite)	22.5	55.9	2550
	23	58.4	26		28	71.1	30		25	63.5	28
	24	60.9	27	31	78.7	33	28		71.1	31	
	25	63.5	28	<b>Lefima</b> (Light)	21.5	54.6	23		30	76.2	33
	26	66.0	29		23	58.4	25	32	81.3	35	
27	68.6	30	24		60.9	26	<b>Gunther Ringer</b> (German Model, Berlin)	20	50.8	2250	
28	71.1	31	26		66.0	2775		23	58.4	25	
29	73.7	32	28	71.1	30	25		63.5	2750		
29*	73.7*	3150	28	71.1	30	28		71.1	3050		
30	76.2	33	<b>Lefima</b> (Baroque)	22	55.9	2425	30	76.2	32		
31	78.7	34		25	63.5	2650	<b>Stotz</b> (Cable)	20	50.8	23	
31*	78.7*	33		<b>Walter Light</b>	16	40.6		19	22	55.9	25
32	81.3	35			18	45.7		21	23	58.4	26
33	83.8	36	20		50.8	23		24	60.9	27	
<b>Dynasty USA</b> (Grand Professional)	20	50.8	22		(after 1986)	21.5	54.7	24	25	63.5	28
	23	58.4	25	23	58.4	26	26	66.0	29		
	26	66.0	28	24	60.9	27	27	68.6	30		
	29	73.7	31	25	63.5	28	28	71.1	31		
	32	81.3	34	26	66.0	2850	29	73.7	32		
	<b>Goodman</b> (Chain)	18	45.7	20	28	71.1	31	30	76.2	33	
		20	50.8	22	29	73.7	3150	31	78.7	34	
		22	55.9	24	31	78.7	34	32	81.3	35	
23		58.4	25	32	81.3	35	<b>Yamaha</b> (3000, 4100 & 4200)	23	58.4	25	
24		60.9	26	33	83.8	36		26	66.0	28	
25		63.5	27	34	86.3	37		29	73.7	31	
26		66.0	28	<b>Ludwig &amp; Ludwig, Leedy &amp; Ludwig, W.F.L. Ludwig, Slingerland</b>	20	50.8		20625	32	81.3	34
27		68.6	29		23	58.4	2425	<b>Yamaha</b> (6100, 6200)	20	50.8	22
28	71.1	30	24*		60.9*	25	23		58.4	25	
29	73.7	31	25*		63.5*	26	26		66.0	28	
30	76.2	32	26	66.0	27	29	73.7		31		
31	78.7	33	*Pre 1978 Sizes	27*	68.6*	28	32	81.3	34		
<b>Goodman</b> (Dresden)	23	58.4	2550	28*	71.1*	29	<b>Yamaha</b> (7100 & 7200*)	20	50.8	22	
	23*	58.4*	25	29	73.7	30		23*	58.4*	25	
	25	63.5	2775	30*	76.2*	31		24	60.9	26	
	25*	63.5*	28	<b>Ludwig Ringer/Rogers</b> (Double Suspension Bowl) (Grand Symphonic, Professional, Standard, Universal)	20	50.8		22	26*	66.0*	28
27*	68.6*	3050	23		58.4	25	27	68.6	29		
28	71.1	31	26		66.0	28	29*	73.7*	31		
<b>GP Percussion</b> (Standard & Baroque)	20	50.8	23		29	73.7	31	32*	81.3*	34	
	22*	55.9*	2350	32	81.3	34	<b>Yamaha</b> (9000)	20	50.8	22	
	24	60.0	2650	<b>Goodman</b> (Early Dresden Models)	24*	60.9*		2550	23	58.4	25
	26	66.0	2850		26	66.0		28	26	66.0	28
29	73.7	3150	29		73.7	31		27	68.6	29	
32	81.3	35	32		81.3	35	29*	73.7*	31		

Some older timpani models have non-standard counterhoop sizes and require custom ordering. For manufacturers not listed above, please measure the outside hoop diameter of the original head.

# EVANS

## Conga Heads

Our goal was to produce a synthetic conga head that is superior to any other synthetic head; one that simulates the sound and feel of animal skin while eliminating the problems associated with natural heads. Evans conga heads provide superior tone, reliable durability, and unsurpassed resistance to climatic and temperature changes. A tapered hoop (which provides better fit on out-of-spec. drums) and "v" shaped radial slits (which help seating of the head) are combined with Evans' Tri-Center dot (similar to dots used on Power Center snare heads). The Tri-Center removes unwanted overtones and adds weight to the center, thus dropping the fundamental frequency and producing more low end. The addition of a specially formulated clear coating keeps the head looking sharp and resists finger oil and dirt build-up. Available to fit LP, TOCA, and MEINL professional series congas.



Heads for LP Extended "Comfort Curve" Hoop Models

<b>EC0975</b>	Fits LP 9.75" Requinto .....	\$104.00
<b>EC1100E</b>	Fits LP 11" Conga.....	106.00
<b>EC1175E</b>	Fits LP 11 3/4" Conga .....	108.00
<b>EC1250E</b>	Fits LP 12 1/2" Conga.....	110.25

Heads for professional LP & Toca Models with "Comfort Curve" hoop

<b>EC1100</b>	Fits 11" LP Professional Series*.....	\$104.00
<b>EC1175</b>	Fits 11 3/4" LP Professional Series*.....	108.00
<b>EC1250</b>	Fits 12 1/2" LP Professional Series*.....	110.25

*Fits Classic/Salsa/Valje (tight fit)/Gio Old Models/Original & Patato*

*Fiberglass/Old Galaxy Fiberglass/Matador Models*

*Fits Limited Edition (LE), Custom Deluxe, and Premier models.*

Patent # 6,184,451

## Bongo Heads

The Tri-Center Bongo heads deliver a bright, penetrating slap with a full, round bottom end, and feature a natural-feeling coating which simulates the touch and response of a natural head. A new tooth-grip extruded hoop, combined with laser cuts around the collar, ensures a clean look, precision tuning, and flawless performances at high tension, while the Tri-Center removes unwanted overtones and enhances the fundamental.



<b>EB07</b>	7" Bongo Head.....	\$69.00
<b>EB09</b>	8 1/2" Bongo Head.....	71.00
<b>EB0709</b>	7" and 8 1/2" Bongo Combo Pack (1 each).....	125.00

Fits: LP Valje & Generation II

Meinl Fibercraft & Wood FWB400

Toca 4500 & 4600.

## J1 for Timbale

These single-ply, 10-mil. heads have a specially etched finish that combines the sustain of an uncoated head with the warmth of a traditional coating. The Evans J1 head delivers a brilliant rimshot without sacrificing depth. Warm and dense in the center with a full sustain at the edges.



<b>E10J1</b>	10" Etched Timbale Head .....	\$28.00
<b>E12J1</b>	12" Etched Timbale Head .....	29.00
<b>E13J1</b>	13" Etched Timbale Head.....	31.25
<b>E14J1</b>	14" Etched Timbale Head.....	33.25
<b>E15J1</b>	15" Etched Timbale Head.....	35.25
<b>E16J1</b>	16" Etched Timbale Head.....	37.50

Fits most manufacturer's timbales.

Specifications subject to change without notice.



<b>Strata 700 (7.5mil)</b>	
<b>CS14S</b>	14" .....\$28.25

<b>Strata 1000 (10mil)</b>	
<b>CT14S</b>	14" .....\$28.50

## Strata™ Concert Snare Heads

The Strata Concert Snare heads yield a darker timbre with a warm, calf-like response. The heads have a natural sustain with midrange overtones. The 700 series (7.5mil) is designed for sensitivity and expression, whereas the 1000 series (10mil) is designed for more robust playing. Strata Staccato comes with a 2mil overtone control ring for increased articulation in either thickness.

<b>Strata Staccato 700 (7.5mil)</b>	
<b>CS14SS</b>	14" .....\$33.50

<b>Strata Staccato 1000 (10mil)</b>	
<b>CT14SS</b>	14" .....\$33.50

## STRATA™ SERIES



## Strata™ 1000 Concert Tom Heads

As the midrange voice within the Strata family, a calf-colored coating provides the 10mil Strata Concert Tom heads with a warm, round tone with darker fundamental.

<b>CT06S</b>	6" .....	\$20.50
<b>CT08S</b>	8" .....	21.50
<b>CT10S</b>	10" .....	24.50
<b>CT12S</b>	12" .....	25.50
<b>CT13S</b>	13" .....	27.50
<b>CT14S</b>	14" .....	28.50
<b>CT15S</b>	15" .....	32.25
<b>CT16S</b>	16" .....	31.75
<b>CT18S</b>	18" .....	52.00



## Strata™ Concert Bass Heads

The Strata Concert Bass Head is a synthetic head with the appearance, warmth and full-bodied tone of calfskin. It features mid-range attack with rich depth of sustain and projection. Available with or without a Central Power Dot, which deepens the fundamental.

### Without Power Center™ Dot

<b>CB2810S</b>	28" Strata 1000 (10 mil) .....	\$148.00
<b>CB3210S</b>	30" Strata 1000 (10 mil) .....	165.50
<b>CB3610S</b>	36" Strata 1000 (10 mil).....	181.25
<b>CB3614S</b>	36" Strata 1400 (14 mil).....	187.25
<b>CB4010S</b>	40" Strata 1000 (10 mil) .....	196.75
<b>CB4014S</b>	40" Strata 1400 (14 mil).....	207.00

### With Power Center™ Dot

<b>CB3614SD</b>	36" Strata 1400 (14 mil) .....	\$194.50
<b>CB4014SD</b>	40" Strata 1400 (14 mil) .....	211.00

# EVANS



## Bulk Packs

Each Evans Bulk Pack holds 10 unpackaged, individually bar-coded drumheads, and less packaging equals a 15% savings per head! The space-saving Bulk Pack fits easily on your countertop or in a Bulk Pack display rack, which holds 2 Bulk Packs and fits on slatwall or pegboard (display rack is FREE with purchase of 2 Bulk Packs or 20 bulk heads).

Item	Description
<b>B14G1-B</b>	Tom Tom 14" Genera G1 Coated .....\$295.00
<b>B14G1D-B</b>	Snare Drum 14" Power Center G1 Ctd.....345.10
<b>B14G1RD-B</b>	Snare Drum 14" Power Center Rev. Dot G1 Ctd.....345.10



## Control Screens for Marching Snare Drums

Evans Control Screen is designed for marching snare drums, the Evans Control Screen offers a simple and effective way to reduce overall volume without sacrificing tone, articulation, or feel. Fitting neatly underneath the drumhead, the Evans Control Screen is simple to install and remove as needed.

<b>EMA13CS1</b>	13" .....\$22.50
<b>EMA14CS1</b>	14" .....22.50

## Min-EMAD™

Min-EMAD (Externally Mounted Adjustable Damping). This extension of the successful EMAD Bass Heads removes unwanted frequencies, but retains the desired attack, tone, and feel. Trim and unobtrusive, the Min-EMAD consists of a fabric "bridge" that links the vibrating head with the relatively inert cunthoop, removing overtones by resisting the motion of the head.

<b>MINEMAD</b>	Tom/Snare Dampers (6).....\$11.50
----------------	-----------------------------------



## Evans Magnetic Head Drum Key

Drop-forged drum key is ergonomically designed for comfort and has a knurled knob for qquick, easy spinning. Its magnetic head helps prevent slipping and stays in place for fast tightening and loosening. Rattle-free design: grips tight to a tension rod during play so it won't buzz.

<b>DADK</b>	Evans Magnetic Head Drum Key .....\$19.50
-------------	---



## Drill Bit Key

(An NS Design Product)

Drop-forged bit key is designed to fit most variable speed cordless drills and screwdrivers. Like the drum key, the bit key has rattle-free design.

<b>DABK</b>	Evans Drill Bit Key .....\$11.50
-------------	----------------------------------



## Evans Torque Key

The Evans Torque Key has an ergonomic grip for maximum comfort, a knurled knob for quick spinning, and a slip-resistant magnetized head which holds the key in place for fast tightening and loosening. The torque handle can be set to a desired tension; when the lug reaches the pre-set tension, it will release, making for even tensioning, and helping drummers attain more accurate tuning.

The Evans Torque Key is not recommended for use with drum hardware.

<b>DATK</b>	Evans Torque Key .....\$46.00
-------------	-------------------------------



## EQ Bass Drum Patches

### Black Nylon

A non-slip flexible Nylon bass drum patch which softens attack and strengthens the head without affecting sound quality.

<b>EQPB1</b>	Single Pedal (x2) .....\$11.00
<b>EQPB2</b>	Double Pedal (x2) .....11.00



### Clear Plastic

A clear non-slip, plastic bass drum patch which increases attack and strengthens the head without affecting sound quality.

<b>EQPC1</b>	Single Pedal (x2) .....\$11.00
<b>EQPC2</b>	Double Pedal (x2) .....11.00



### Evans EQ Pad (Bass Drum Muffling Pad)

The EQ Pad is a highly efficient bass drum muffler that attaches to the bottom of the bass drum shell with Velcro®. The hinged pad bounces off the head, allowing sustain, before returning to damp the vibrating head.

<b>EQPAD</b>	Bass Drum Muffling Pad .....\$37.00
--------------	-------------------------------------



### AF Patch

Made of Aramid Fiber, the material commonly found in bullet-proof vests, the patch stays on the head permanently with a high-tech adhesive. The AF Patch not only provides unsurpassed durability, it also emphasizes attack characteristics. While the center of the Patch is solid for maximum durability, four radial slits along the perimeter allow the head to vibrate naturally for better tone and feel.

<b>EQPAF1</b>	Bass Drum AF Patch (2-1/2" diameter).....\$16.00
---------------	--



**FAX & E-MAIL ORDERS FOR PRINTED  
MUSIC WILL GET AN EXTRA  
5% DISCOUNT**

**FAX:  
(708) 496-2130  
(888) 983-5537**

**E-MAIL:  
sales@harristeller.com**

## CANNON MUFFLERS



Shell length, foam rubber, bass drum mufflers. Mount inside bass drum.

**UPCBM14** 14" Bass Drum.....**\$23.00**  
**UPCBM16** 16" Bass Drum.....**44.00**

## RTOM MOONGEL



**MG004** Moongel .....**\$8.99/4**

## REMO MUFFLS



MF2012

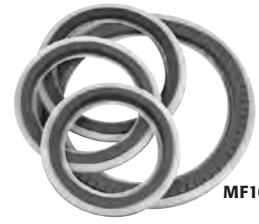

MF1012

DRUM SIZE	SOUND CONTROL	PRICE	RING CONTROL	PRICE
<b>BATTER</b>				
8"			<b>MF1008</b> .....	<b>\$10.00</b>
10"	<b>MF2010</b> .....	<b>\$19.00</b>	<b>MF1010</b> .....	<b>11.00</b>
12"	<b>MF2012</b> .....	<b>22.60</b>	<b>MF1012</b> .....	<b>12.70</b>
13"	<b>MF2013</b> .....	<b>24.00</b>	<b>MF1013</b> .....	<b>15.10</b>
14"	<b>MF2014</b> .....	<b>2720</b>	<b>MF1014</b> .....	<b>15.70</b>
15"			<b>MF1015</b> .....	<b>16.80</b>
16"	<b>MF2016</b> .....	<b>29.40</b>	<b>MF1016</b> .....	<b>17.90</b>
18"	<b>MF2018</b> .....	<b>34.90</b>	<b>MF1018</b> .....	<b>21.80</b>
<b>BASS</b>				
20"	<b>MF2120</b> .....	<b>\$58.60</b>	<b>MF1120</b> .....	<b>\$29.20</b>
22"	<b>MF2122</b> .....	<b>64.60</b>	<b>MF1122</b> .....	<b>31.40</b>
24"			<b>MF1124</b> .....	<b>33.60</b>
<b>MF0090</b>	9" Muffl Strip .....			<b>\$45.70/2</b>

## REM'OS

**RO-0014** 14", 2-1", 1 1/2" .....**\$10.50**  
**RO0244** 10", 12", 2-14" .....**15.80**  
**RO0246** 10", 12", 14", 16" .....**15.80**  
**RO2346** 12", 13", 14", 16" .....**15.80**  
**RO0236** 1 ea. 10, 12, 13, 16" ..**15.80**  
**CC005200** 2.5" Crown .....**15.25/5**  
**CC002700** 7.25" Crown .....**12.85/2**



## E RINGS



(10 Per Pack)  
**E10ER1** 10" - 1" .....**\$46.00**  
**E12ER15** 12" - 1.5" .....**46.00**  
**E13ER15** 13" - 1.5" .....**46.00**  
**E14ER1** 14" - 1" .....**46.00**  
**E14ER15** 14" - 1.5" .....**46.00**  
**E14ER2** 14" - 2" .....**46.00**  
**E15ER2** 15" - 2" .....**46.00**  
**E16ER2** 16" - 2" .....**46.00**  
**E18ER2** 18" - 2" .....**46.00**  
**ERFUS** 1 ea. 10, 12, 2-14" .....**17.00**  
**ERSTD** 1 ea. 12, 13, 14, 16" .....**20.00**

## WECKL MUFFLERS

Complete bass drum control. Full head vibration

**HKMUFF18** 18" Bass.....**\$31.10**  
**HKMUFF20** 20" Bass.....**28.75**  
**HKMUFF22** 22" Bass.....**34.90**  
**HK2417** Damper System....**42.30**

## DYNAMOS



Set of 3 (5", 7", 9") Black Hole-cutting adhesive-backed templates for front Bass drum head.

**DM057970** .....**\$32.50**  
**DMBHO310** 3" Biohazard .....**21.50**  
**DMFL0510** 5" Flame .....**21.50**  
**DMPC0610** 6" Peace Sign .....**21.50**  
**DMSW0510** 5" Sawblade .....**21.50**

## HOLZ



**SN4W** 4" White .....**\$14.90**  
**SN5W** 5" White.....**15.90**  
**SN6W** 6" White.....**16.55**  
**SN4BK** 4" Black .....**14.90**  
**SN5BK** 5" Black .....**15.90**  
**SN6BK** 6" Black .....**16.55**  
**SC10HC** Speedcutterz .....**14.20**

## ATTACK

### CONTROL RINGS

**UPOR10** .....**\$5.50 ea.**  
**UPOR12** .....**5.75 ea.**  
**UPOR13** .....**6.00 ea.**  
**UPOR14** .....**6.75 ea.**

## AQUARIAN



### STUDIO RINGS

**AQSR1** 12", 13", 14", 16" .....**\$13.70**  
**AQSR2** 10", 12", 14", 16" .....**13.70**  
**AQSR3** 6 Ea. 14" .....**20.50**  
**AQSR4** 2 Ea. 15" .....**10.25**  
**AQSR5** 2 Ea. 18" .....**10.25**  
**AQSR6** 6 Ea. 13" .....**20.50**  
**AQSR7** 6 Ea. 10" .....**20.50**  
**AQSR8** 6 Ea. 12" .....**20.50**  
**AQSR9** 6 Ea. 16" .....**20.50**  
**AQSR10** 1 Ea. 10", 12", 2-14" .....**13.70**

### PORTHOLES (5")

**AQPHW** White .....**\$7.95**  
**AQPHB** Black .....**7.95**

## ZERORINGS



Zerorings are available in three handy, pre-packaged sets Z1: 1", 1-1/2", and 2" rings for 14" snare drums; the Z2 includes 1" rings for 10", 12", and 13" toms; and the Z3 contains 1" wide, 14" and 16" rings for snare and floor drums.

**Z1** Snare .....**\$9.70**  
**Z2** Tom Tom .....**9.70**  
**Z3** Floor Tom .....**9.70**

## KICK PADS



**DAN210** Danmar, Hard Center .....**\$8.70**  
**DAN210DK** Double Kick Pad .....**10.80**  
**DAN210MK** Danmar, Metal.....**12.00**  
**DAN210MKD** Double Metal.....**13.50**  
**AQKP1** Single Kick Pad, Aquarian .....**9.10**  
**AQDKP2** Double Kick Pad, Aquarian .....**11.35**  
**AQSTKP1** Thin Single Pad .....**9.10**  
**AQSTKP2** Thin Double Pad.....**11.35**  
**EQPB1** Single Pad, Evans, Black.....**11.00**  
**EQPB2** Double Pad, Evans, Black .....**11.00**  
**EQPC1** Single Pad, Evans, Clear .....**11.00**  
**EQPC2** Double Pad, Evans, Clear.....**11.00**  
**UPIP6** 6 Pack, Leather, Cannon .....**21.00**  
**UPIP** .....**35.00**  
**UPFD** 12 Pack, Felt, , Cannon.....**10.50**  
**UPFD4** 4 Pack, Felt, Cannon .....**6.00**  
**3269** 3 1/2" Pads, 12 Pk, Duplex.....**7.95**  
**KS0004PH** Falam Slams (2), Remo .....**14.70**  
**KS0006PH** Double Falam Slam, Remo .....**14.70**  
**KS0002PH** 2.5" Falam Slam (2), Remo .....**9.70**  
**KS0012PH** 2.5" Double Kick, Remo .....**8.40**  
**DPW** Double Pad / Kickport (2).....**6.99**  
**DPBK** Double Pad / Kickport (2).....**6.99**

## KICKPORT



It ports the kick drum in the same manner as a bass reflex speaker cabinet which boosts low frequencies.

<b>KP2W</b>	White .....	<b>\$59.95</b>
<b>KP2BK</b>	Black .....	<b>59.95</b>
<b>KP2C</b>	Chrome Kickport .....	<b>64.99</b>
<b>KP2GO</b>	Gold Kickport .....	<b>64.99</b>
<b>KP2R</b>	Red Kickport .....	<b>59.99</b>
<b>KP2SS</b>	Elements Series Sliver Sand Kickport .....	<b>64.99</b>
<b>KP2CD</b>	Elements Series Candy Kickport.....	<b>64.99</b>
<b>KP2GR</b>	Elements Series Granite Kickport.....	<b>64.99</b>
<b>KP2SS</b>	Elements Series Silversand Kickport.....	<b>64.99</b>

Create a richer full-range response from your cajon. The CajonPort™ delivers more depth presence and precision, adding incredible enhanced low-end.

<b>CP1BK</b>	Black Cajonport .....	<b>\$59.99</b>
<b>CP1W</b>	White Cajonport.....	<b>59.99</b>
<b>CP1SS</b>	Elements Series Sliver Sand Cajonport .....	<b>64.99</b>
<b>CP1CD</b>	Elements Series Candy Cajonport .....	<b>64.99</b>
<b>CP1GR</b>	Elements Series Granite Cajonport .....	<b>64.99</b>

Designed for the batter head, FX Series™ ports reduce unwanted overtone to produce warmer, more focused resonant notes that project more of the natural tone of your drum.

### Single Drum FX Ports

<b>FX1SN</b>	1" port for snare 12-15" .....	<b>\$26.99</b>
<b>FX1RT</b>	1" port for toms 10-14".....	<b>24.99</b>
<b>FX2FT</b>	2" port for toms 16-20".....	<b>28.99</b>
<b>FX2BD</b>	2" port for bass drum 16"+ .....	<b>29.99</b>
<b>DPW</b>	White Impact D-Pads .....	<b>6.99/2</b>
<b>DPBK</b>	Black Impact D-Pads .....	<b>6.99/2</b>
<b>TRW</b>	White T-Reinforcement Ring .....	<b>5.99/1</b>
<b>TRBK</b>	Black T-Reinforcement Ring.....	<b>5.99/1</b>

## SOUNDOFF SILENCERS



<b>SO6</b>	6" Tom Mute .....	<b>\$8.99</b>
<b>SO8</b>	8" Tom Mute .....	<b>9.99</b>
<b>SO10</b>	10" Tom Mute.....	<b>10.99</b>
<b>SO12</b>	12" Tom Mute.....	<b>11.99</b>
<b>SO13</b>	13" Tom Mute.....	<b>12.99</b>
<b>SO14</b>	14" Tom Mute.....	<b>13.99</b>
<b>SO15</b>	15" Tom Mute.....	<b>15.99</b>
<b>SO16</b>	16" Tom Mute .....	<b>17.99</b>
<b>SOBASS</b>	Bass Mute 18" thru 26".....	<b>65.99</b>
<b>SOCYM</b>	Cymbal Mute.....	<b>10.99</b>
<b>SO14HAT</b>	14" Hi-Hat Mute.....	<b>20.99</b>
<b>SO20RIDE</b>	20" Ride Mute .....	<b>29.99</b>

### ASSORTMENTS

<b>SO0244</b>	Drum Mute Pak – Fusion Sizes.....	<b>\$42.99</b>
<b>SO2346</b>	Drum Mute Pak – Standard Sizes.....	<b>47.99</b>
<b>SOSETFSN</b>	Box Set – Fusion .....	<b>154.99</b>
<b>SOSETSTD</b>	Box Set – Standards with Cymbal Mutes .....	<b>159.99</b>

## GIBRALTAR PORT HOLE PROTECTOR RINGS

Available in 4 and 6 inch sizes, these two piece rings snap onto both sides of the bass drum head.

<b>SCGPHP4B</b>	4" Black.....	<b>\$13.95/2 pk.</b>
<b>SCGPHP4C</b>	4" Chrome .....	<b>14.85/2 pk.</b>
<b>SCGPHP4W</b>	4" White .....	<b>13.95/2 pk.</b>
<b>SCGPHP6B</b>	6" Black.....	<b>15.75/2 pk.</b>
<b>SCGPHP6C</b>	6" Chrome .....	<b>16.65/2 pk.</b>
<b>SCGPHP6W</b>	6" White .....	<b>16.65/2 pk.</b>
<b>SCGPHCUT</b>	Speed Cutter .....	<b>15.30</b>

## ROCK N ROLLER CARTS

**Model R2 (MICRO)** – RNR's smallest model expands from 26"-39" in length with 25/20 (front/rear) foldable sides. 6" x 1.50" rear wheels and 4" x 1.0" front swivel casters. Load capacity: 350 lbs.

**VARR2.....\$158.60**



**Model R6 (MINI)** – Frame telescopes from 28"-42.5" in length with 24" foldable sides. 8" x 2.50" pneumatic rear wheels and 4" x 1.0" front swivel casters. Load capacity: 500 lbs.

**VARR6.....\$213.30**



**Model R8 (MID)** – Identical to MAX except with 8" x 2.5" pneumatic rear wheels resulting in 20% smaller storage footprint than MAX. Load capacity: 500 lbs.

**VARR8.....\$246.95**



**Model R10 (MAX)** – Frame telescopes from 34"-52" in length with 32" foldable sides to stack high loads. 10" x 3.0" pneumatic rear wheels and 5" x 1.25" front swivel casters. Load capacity: 500 lbs.

**VARR10.....\$269.40**

**VARR12 (8" x 2") Front Tires.....\$352.55**

Two 6" x 1.50" front swivel casters with brakes and 8" x 2.0" R-Track rear no-flat tires make rolling over grass and uneven sidewalks easy, and the entire chassis sits lower to the ground for easier loading and unloading. The frame extends from 42" to 60" in length (designed to transport up to 700 pounds per trip).

**VARR14.....\$330.55**



# PEAVEY MICROPHONES

## PV<sup>®</sup>i 100 MICROPHONE

- Dynamic cardioid vocal microphone designed for stand-mount application
- Package Includes PV i 100, carrying pouch, mic clip and 6 meter mic cable
- Available with XLR to XLR or XLR to 1/4" cable
- POP clam shell packaging



00577800 PV<sup>®</sup>i 100 Microphone - XLR w/ clam shell.....\$29.99  
 00577810 PV i 100 Microphone - 1/4" w/ clam shell.....\$29.99

## PV<sup>®</sup>i 2i MICROPHONE

- Package includes PV i 2 dynamic cardioid microphone, 6 meter microphone cable, mic clip, and carrying pouch
- Finish options - black, gold or white
- Available with XLR to XLR or XLR to 1/4" cable



00496570 PV i 2 Microphone - 1/4" cable.....\$59.99  
 00496360 PV i 2 Microphone - XLR cable.....\$59.99  
 00593440 PV i 2W Microphone - XLR cable.....\$84.99  
 00593500 PV i 2W Microphone - 1/4" cable.....\$84.99  
 00593430 PV i 2G Microphone - XLR cable.....\$84.99  
 00593490 PV i 2G Microphone - 1/4" cable.....\$84.99

## PV<sup>®</sup>i 3 MICROPHONE

- Super-cardioid dynamic vocal microphone package include PV i 3 microphone, 6 meter XLR to XLR microphone cable, mic clip, and carrying pouch
- Features specially designed rubber ring around a hardened mesh grill to guard against damage from impact
- Extended high-frequency response covers a wide range of the frequency spectrum
- POP clam shell packaging



03569810 PV i 3 Microphone - XLR cable .....\$69.99

## PV<sup>®</sup> 7 MICROPHONE

- Dynamic cardioid microphone designed for vocal application
- Ideal karaoke microphone
- Includes either XLR to XLR or XLR to 1/4" microphone cable

03013490 PV<sup>®</sup>7 Microphone - XLR .....\$24.99  
 00597360 PV<sup>®</sup>7 Microphone - 1/4".....\$24.99

## PVM<sup>®</sup> 45i<sup>r</sup> MICROPHONE

- Super cardioid dynamic instrument microphone
- Neodymium magnet
- Package includes PVM 45i<sup>r</sup> and 6 meter XLR to XLR mic cable



00593450 PVM<sup>™</sup> 45i<sup>r</sup>.....\$129.99

## H-5<sup>™</sup> AND H-5C<sup>™</sup> MICROPHONES

- Expressive, responsive omni-directional dynamic harmonica microphone
- Contoured black housing with finger placement grooves and brushed aluminum grille
- Center-detent volume control
- Includes detachable mini-XLR to 1/4" mic cable
- On/off switch
- Carrying case included



00563080 H-5C<sup>™</sup> Cherry Bomb<sup>™</sup> Red w/ Black Grill.....\$179.99  
 00597360 H-5<sup>™</sup> Harmonica Mic, Black w/ Aluminum Grill.....\$179.99

## STUDIO PRO<sup>®</sup> CM1 MICROPHONE

- Cardioid condenser hand held microphone
- Medium format element
- Ideal for vocal or instrumental pickup
- Mic incorporates dual-layer pop filter



00576730 Studio Pro<sup>®</sup> CM1 .....\$199.99

## VCM<sup>®</sup> CHOIR MICROPHONE

- Miniature, cardioid pattern, electret condenser choir microphone
- 9-52 Volt phantom power
- Designed to be suspended over choirs, instrumental ensembles, or stage areas for sound reinforcement and recording applications
- Available in black or white finish



00577970 VCM<sup>™</sup> 3 Choir Microphone - Black.....\$199.99  
 00577960 VCM 3 Choir Microphone - White.....\$199.99



## PVM<sup>®</sup> DMS-5 DRUM MIC SYSTEM

- A complete drum microphone system all in one package
- Package includes one PVM<sup>™</sup> 321 Kick Drum, One PVM 325 snare mic, three PVM 328 tom mics, four drum mount clips, four mic cables with 90 degree XLR connectors, one mic cable with straight XLR connectors and carrying case

00493130 PVM<sup>™</sup> DMS-5 Drum Mic System .....\$499.99



## PV<sup>®</sup> MSP1 MICROPHONE PACKAGING

- Complete microphone/microphone stand package
- Includes PV i 100 dynamic cardioid mic, tripod mic stand with boom, 6 meter mic cable, mic clip, mic carrying pouch, and convenient zippered nylon carry bag
- Available with XLR to XLR or XLR to 1/4" cable
- POP packaging

00578000 PV<sup>®</sup> MSP1 Microphone XLR/Mic Stand Package .....\$59.99  
 00579890 PV MSP1 Microphone 1/4" /Mic Stand Package .....\$59.99



## 6 SPACE AND 12 SPACE MIC BAGS

- Padded 6 space and 12 space mic bags with accessory pouch
- Includes Peavy logo luggage tag for easy identification

03011860 6 Space Mic Bag .....\$39.99B  
 03011870 12 Space Mic Bag .....\$49.99B



# PEAVEY PORTABLE P.A.

## Messenger®

At 24" wide and just 24 lbs., the Messenger® is completely self contained and sets up in seconds. The Messenger features a robust five-channel mixer with FLS® Feedback Locating System and a 100-watt output that makes it ideal for an endless array of applications, from open-mic performances to presentations and meetings to karaoke.

**00573540** Messenger .....\$499.99B  
**00590200** Messenger Speaker Stands Package .....49.99B

Includes two stands with adapters. Designed for use with Messenger speakers only. Durable black powder coat finish. Zippered nylon carrying bag included.

### Split Track Mix™



As featured on the Peavey Messenger portable audio system, Split-Track Mix allows you to adjust the volume of vocals and backing tracks on split-accompaniment recordings, so you can have as much or as little of the original vocals in the mix as you want. Great for churches and karaoke!



**Karaoke**

**Conferences**

**Presentations**



**A complete, portable sound system as convenient as a briefcase.**

# PEAVEY PORTABLE P.A.

## Escort® 3000

### Convenient, all-in-one P.A. system with wheels.

300 Watts (150 x 2) • Two-way speaker system with 10" woofer • 7 channels • Custom rubberized knobs • 6 combination XLR 1/4" inputs • RCA/3.5 TRS media inputs • USB MP3 playback • Patented FLS® (Feedback locating system) • Digital multi-effects • Mid-morph® • LCD screen for ease of file playback and effect selection • Seven-band graphic equalizer • Two folding speaker stands • Two 15' speaker cables • Storage compartment for optional accessories • Convenient package with luggage-style wheels.

03608880 ESCORT 3000 W/O STAND – IMP-120V .....\$999.99B  
 00496340 Escort Stand .....59.99B



## Escort® 5000

### Convenient, all-in-one P.A. system with wheels.

500 Watts (250 x 2) • Two-way speaker system with 10" woofer • 8 channels • Custom rubberized knobs • 7 combination XLR 1/4" inputs • RCA/3.5 TRS media inputs • USB MP3 playback • Patented FLS® (Feedback locating system) • Digital multi-effects • Mid-morph® • LCD screen for ease of file playback and effect selection • Seven-band graphic equalizer • Monitor send • Subwoofer output • Two folding speaker stands • Two 15' speaker cables.

The carrying case provides storage for everything needed for sound, including plenty of room for optional accessories such as microphones and cables. In addition to the included folding speaker stand, the case even includes luggage style wheels to roll the entire system away. No heavy lifting, just heavy audio!

03608930 ESCORT 5000 W/O STAND .....\$1199.99B  
 00496340 Escort Stand .....59.99B



#### FLS® Feedback Locating System

Feedback is a potential problem with any room and any sound system, but our patented Feedback Locating System helps you locate and stop the offending frequencies with great precision. At the onset of feedback, an LED will glow above the problematic frequency band. All you have to do is bring down that fader until the LED fades, or the feedback stops. By knowing exactly which frequency band to cut, you can avoid cutting useful audio that is not contributing to the feedback.

## EV MICROPHONES



Miniature cardioid hanging mic with 30 foot cord.  
**CH230** Black.....\$344.25B



Dynamic omni-directional delivers clean audio under adverse conditions.  
**635A** .....\$219.00B  
 \* = Call for Dealer Net



**N/DYM**  
 Unidirectional lead/backup vocal microphone. One of the best choices for entry level vocal applications. Frequency response: 45Hz to 15kHz.  
**ND267A** w/o cord.....\$110.00B  
**ND267AS** w/o cord.....\$124.00B



Top-class vocal microphone, multi-stage shock mount for unmatched low-handling noise, condenser mic performance.  
**ND767A**.....\$183.00B



Probe style true condenser instrument mic with cardioid pickup pattern.  
**RE200**.....\$549.00B  
**RE510**.....\$379.00B



**N/DYM**  
 Super cardioid vocal microphone. The ND767a provides the clarity and feedback rejection needed in demanding applications. Frequency response: 35Hz to 22kHz.  
**ND967** Concert Vocal.....\$211.00B



**N/DYM**  
 Unidirectional instrument microphone. The N/D478 provides the instrumentalist with warmth and clarity. Frequency response: 45Hz to 15kHz.  
**ND478** w/o cord.....\$124.00B

## AUDIO TECHNICA MICROPHONES



Tuned for clear extended-range vocal reproduction, the premier Artist Series dynamic vocal mic is equipped with a neodymium magnet & a tight hypercardioid polar pattern.  
**ATM610A**.....\$246.35



The ATM450 offers an innovative side-address stick design for endless placement options. Switchable 10dB pad, integral hi-pass filter. Requires 11-52V phantom power.  
**ATM450**.....\$419.45



This cardioid dynamic workhorse is designed for smooth, natural vocal reproduction and low noise.  
**ATM410**.....\$129.05



A natural with high SPLs, the ATM250 hypercardioid dynamic is tailored for kick drum, percussion, brass and other highly dynamic instruments.  
**ATM250**.....\$302.65



*"Resellers of Audio-Technica products must be authorized by Audio-Technica, U.S., Inc. in order to advertise and sell product on the internet and otherwise. Application may be obtained by contacting salespolicies@atus.com. Upon approval, reseller will receive an Authorized Internet Reseller Badge to identify them to consumers as a factory approved reseller of Audio-Technica products."*



This cardioid dynamic workhorse is designed for smooth, natural vocal reproduction and low noise. The multi-stage grille design for excellent protection against plosives. Its cardioid polar pattern reduces pickup of sounds from the sides and rear, maximizing isolation from other sound sources and minimizing feedback.  
**ATM510**.....\$161.90



The ATM250DE features two elements in one housing. Audio-Technica's innovative use of two polar patterns is ideal for kick drum.  
**ATM250DE**.....\$513.80



Vocal condenser microphone is tailored for high-fidelity vocal reproduction. The microphone is equipped with a 10dB pad and integral hi-pass filter. It requires 11-52V phantom power.  
**ATM710**.....\$326.10



The AT2022 is a condenser microphone designed for stereo recording. Two unidirectional condenser capsules in an X/Y configuration pivot.  
**AT2022**.....\$410.55

# AUDIO TECHNICA MICROPHONES



Professional-quality vocal pickup with hands-free operation. Low-visibility, lightweight headband and cushioned support pads provide a stable, comfortable fit. Pivot-mounted flexible mic boom descends from left or right side.

**PRO8HEX** .....\$185.35



Offers the convenience of high-quality stereo pickup in a single microphone. Compact, lightweight design is perfect for camera-mount use. Pair of cardioid condenser elements in X/Y configuration. Provides the spatial impact and realism of a live sound field.

**PRO24** .....\$138.40



The AT2010 is designed to bring the studio-quality articulation and intelligibility of Audio-Technica's 20 Series to the stage, for crystal-clear vocal performances.

**AT2010 Stage**.....\$161.90



Designed for close-up vocal use with superior sound quality and low handling noise. Detachable cable.

**PRO31 XLR-XLR**.....\$75.10  
**PRO31QTR XLR - 1/4"**.....75.10



Ideal for high-SPL applications such as sax, toms, brass and percussion. Extended frequency response captures subtle nuances of the performance. UniMount® Clip permits accurate positioning.

**PRO35** .....\$302.65



Ideal for acoustic guitar, overheads, piano, group vocals and high-SPL applications. Professional performance for studio recording and live sound reinforcement.

**PRO37** .....\$293.25



Provides natural, full-range vocal reproduction; outstanding sound quality. Silent on-off operation thanks to MagnaLock™ switch design.

**PRO41**.....\$114.95



Premier Pro Series vocal microphone delivers excellent gain before feedback and outstanding stage presence. New look, improved sound, lower price. Two-stage ball-type head-case reduces wind noise.

**PRO61** .....\$138.40



Ideal for musical instrument pick-up and general use. Tailored response provides natural, full-range reproduction. Rugged design and construction for reliable performance.

**PRO63** .....\$105.60



Provides articulate, full-sounding voice and instrument pickup. Excels in pickup of acoustic guitar with included guitar mount.

**PRO70** .....\$246.35



Equipped with a wide-range condenser element, low-mass diaphragm, and self-contained electronics.

Direct mounts to any 5/8"-27 stand, or to included threaded mounting stud 3.0 m (9.8') cable permanently attached between mic and XLRM-type connector. Offered in two lengths: 12.40" (PRO 47T); 15.79" (PRO 47TL)

**PRO47T** .....\$269.80  
**PRO47TL** .....269.80



USB Cardioid Condenser Mic - Windows & Mac Compatible

**AT2020USB** .....\$255.75  
**AT2020 Studio** .....161.90  
**AT2005USB USB/XLR**.....138.45



With robust construction and unobtrusive appearance, the PRO 45 offers versatile sound-reinforcement solutions for speech, theater, orchestra and choir sound reinforcement and recording. The mic's high-SPL handling is perfect for suspension over choirs and orchestras.

7.6 m (25') cable permanently attached between microphone and XLRM-type connector.

**PRO45** .....\$215.85  
**PRO45W White** .....215.85



Equipped with a wide-range condenser element, low-mass diaphragm, and self-contained electronics.

Plugs into any standard XLRM-type surface or cable connector. Flat, smooth frequency response. Cardioid polar pattern reduces pickup from sides/rear. Offered in two lengths: 13.07" (PRO 49Q); 16.46" (PRO 49QL)

**PRO49Q**.....\$244.00  
**PRO49QL**.....244.00

[www.audio-technica.com](http://www.audio-technica.com)

# AUDIO TECHNICA MICROPHONES



Side-address cardioid studio condenser microphone. XLRM-type output. Roll-off switch and 10 dB pad. 11-52V phantom power. Includes AT8458 shock mount and protective pouch for mic.

**AT2035** .....\$244.00



Multi-pattern side-address studio condenser microphone with switchable cardioid, omnidirectional and figure-of-eight polar patterns. XLRM-type output. Roll-off switch and 10 dB pad. 11-52V phantom power.

**AT2050** .....\$368.35



Drum microphone Kitpak™ includes four cardioid dynamic drum microphones (two SNARE/TOM mics and two KICK/TOM mics), a durable carrying case and a bonus drum key.

**MBDK4** .....\$245.15



## Phantom Power Supply

**AT8801** .....\$110.25  
Single-channel 24V phantom power supply (AC powered)



**ATR6550** Shotgun .....\$124.80B  
**ATR6250** Stereo .....77.99B



Unidirectional polar pattern provides superior reflection of off-axis sound.  
**ATR1200** .....\$31.20B



ATR355 Provides excellent wide-range response while remaining practically invisible.  
**ATR3350** .....\$42.35B

## SIGNAL FLEX



Phantom Power Supply – powers one or two condenser microphones at either 12 volts DC or 48 volts. AC adapter included. Male and female XLR connectors.

**SF8060** .....\$94.50

## VOCAL



High-output design for vocals that cut through the mix.

**MB1KC** .....\$72.75

## MIDNIGHT BLUE

## INSTRUMENT



Tailored frequency response for optimal instrument reproduction.

**MB2KC** .....\$97.35

## MICROPHONE SCREENS



Heavy gauge wire mesh and all metal construction affords original equipment protection!

**MB58C** Chrome .....\$16.45

**MB58G** Gold .....15.85

## ON STAGE

**SP58** Steel Gray .....12.99

## VOCAL



Extended frequency response for optimal vocal reproduction.

**MB3KC** .....\$97.35

## CONDENSER



Condenser design for studio-quality vocal and instrument applications.

**MB4KC** .....\$184.15

# CAD AUDIO



## GXLV Wireless Microphone System

The GXLV VHF receiver features two channels of VHF wireless conveniently engineered into one chassis. It includes XLR and 1/4" discrete outputs and XLR as a mix output of the two channels. The GXLV receiver has RF and AF indicator lights and volume controls. GXLV wireless is offered with a choice of handheld or bodypack transmitters and all bodypack systems are supplied with a guitar cable and a condenser headworn mic at no additional charge. Handheld transmitter outfitted with on/off and mute function for flexibility of use. Battery life of >10 hrs. Handheld transmitter features battery life indicator.

- GXLVHH** VHF Dual Handheld Wireless System .....\$142.23B  
**GXLVHB** VHF Combo Wireless System (includes 1 Handheld,  
 1 Headworn & Bodypack w/Guitar Cable) .....142.23B



## GXLU Wireless Microphone System

The GXLU UHF receiver features two channels of UHF wireless, also engineered into one chassis. The GXLU receiver is outfitted with XLR and 1/4" connectors as discrete outputs and XLR as mix output of the two channels. The receiver also includes RF and AF indicator lights and volume controls. GXLU wireless is also offered with a choice of handheld or bodypack transmitters. All bodypack systems are supplied with guitar cable and condenser headworn mic at no additional charge. Handheld transmitter outfitted with on/off and mute function for flexibility of use. Battery life of >10 hrs. Handheld transmitter features battery life indicator.

- GXLUHH** UHF Dual Handheld Wireless System.....\$226.74B  
**GXLUHB** UHF Combo Wireless System (includes 1 Handheld,  
 1 Headworn & Bodypack w/GTR Cable) .....226.74B



## Stagepass™ Wireless System

VHF Channelization for increased operating range, diversity operation to minimize multipath interference, 16 channel agility for frequency plan flexibility, Scan-Link™ technology for instantaneous and automatic channel configuration. First, the receiver conducts an environmental frequency evaluation, then selects a channel. Second, the receiver links to the transmitter and sets the transmit frequency automatically. Double AA batteries with >10 hrs. of battery life, transmitters have soft touch On & Mute switches with multi-color LED indicators, metal chassis for a durable and formidable shielded enclosure, 1/4" and XLR outputs for maximum flexibility.

### Includes:

- 1 - RX1200 Receiver  
 1 - TX1200 Cardioid Dynamic Handheld Transmitter  
**WX1200** VHF Handheld System.....\$286.51B

## The StagePass™ WX1210 Bodypack Series

Includes the following features: VHF Channelization for increased operating range, diversity operation to minimize multipath interference, 16 channel agility for frequency plan flexibility, Scan-Link™ technology for instantaneous and automatic channel configuration. First, the receiver conducts an environmental frequency evaluation, then selects a channel. Second, the receiver links to the transmitter and sets the transmit frequency automatically. Double AA batteries with >10 hrs. of battery life, transmitters have soft touch On & Mute switches with multi-color LED indicators, metal chassis for a durable and formidable shielded enclosure, 1/4" and XLR outputs for maximum flexibility.

- WX1210GTR** Guitar Microphone System .....\$286.51B  
 Includes RX1200 Receiver, TX1210 Bodypack Transmitter and WXGTR Instrument Cable.  
**WX1210LAV** Lavalier Microphone System .....\$286.51B  
 Includes RX1200 Receiver, TX1210 Bodypack Transmitter and WXLAV Cardioid Condenser Lavalier Microphone.  
**WX1210HW** Headworn Microphone System.....\$286.51B  
 Includes RX1200 Receiver, TX1210 Bodypack Transmitter and WXHW Hypercardioid Condenser Headworn Microphone.

## Stagepass™ Wireless System

The StagePass™ WX1220 Combo System includes the following features: VHF Channelization for increased operating range, diversity operation to minimize multipath interference, 16 channel agility for frequency plan flexibility, Scan-Link™ technology for instantaneous and automatic channel configuration. First, the receiver conducts an environmental frequency evaluation, then selects a channel. Second, the receiver links to the transmitter and sets the transmit frequency automatically. Double AA batteries with >10 hrs. of battery life, transmitters have soft touch On & Mute switches with multi-color LED indicators, metal chassis for a durable and formidable shielded enclosure, 1/4" and XLR outputs for maximum flexibility.

### Includes:

- 1 - Handheld  
 1 - Bodypack w/GTR Cable  
 1 - Headworn  
**WX1220** VHF Combo System .....\$360.72B



## Cardioid Handheld Condenser Microphone

Designed for demanding vocalists, the C195 low noise, electric condenser microphone delivers superlative performance on-stage. Transformerless electronics optimize the C195's Flex-Form™ hardened steel grille screen dramatically resists deformation while diminishing the risk of poor performance caused by a bent or dented ball screen. CAD's (I.N.R.™-3) Impact Noise Reduction system optimizes performances in live settings. A durable "soft-feel" coating provides additional protection and reliability. **Mic clip and 15' XLRM to XLR microphone cable included.**

- C195** .....\$142.23B



## Supercardioid Handheld Neodymium Dynamic Microphone

The D189 is a rugged dynamic microphone that delivers exceptional sound quality in a variety of live sound applications. The mic's proprietary Flex-Form™ hardened steel grille screen withstands deformation caused by on-stage abuse. CAD's (I.N.R.™-2) Impact Noise Reduction system optimizes performance in live settings. A durable "soft-feel" coating provides extra protection and ensure greater reliability. The D189 is ideas for those who want exceptional sonic performance and durability in a live microphone. **Mic clip and 15' XLRM to XLR microphone cable included.**

- D189** .....\$121.60B



## Cardioid Handheld Dynamic Microphone

Excellent for vocals and instruments. Wide frequency response for accurate, natural sound reproduction. Cardioid polar pattern for superior feedback rejection. Flex-Form hardened steel grille for durable performance. **Includes mic clip. Recessed on/off switch. All-metal housing.**

- CAD12** .....\$39.16B

# CAD AUDIO



## Black Pearl Chrome Finish Cardioid Condenser Microphone

Finished in lustrous black pearl chrome, the compact and durable GXL1200BP condenser is known for its open, transparent sound. Its transformerless design reduces distortion and optimizes low-end response. A uniform cardioid pattern controls feedback. The GXL1200BP's small size, accuracy, and high SPL capability, make it ideal for miking overheads, high hats, cymbals, and stringed instruments. **Mic clip, vinyl pouch and polishing cloth included.**

**GXL1200BP .....\$101.00B**



## Black Pearl Chrome Finish Cardioid Condenser Microphone

Offering exceptional value, the GXL2200BP is a large diaphragm condenser microphone finished in lustrous black pearl chrome. The GXL2200BP's capsule features a sophisticated 1" gold-vapor deposited diaphragm. Exceptional sensitivity and low distortion make it an outstanding performer in a variety of live and recording applications. **Shock mount, vinyl pouch and polishing cloth included.**

**GXL2200BP .....\$121.61B**



## Black Pearl Chrome Finish Multi-Pattern Condenser Microphone

Finished in lustrous black pearl chrome, the GXL3000BP features a precision engineered 1" gold-vapor deposited multi-pattern (cardioid, omni, figure-of-eight) dual diaphragm capsule for exceptional accuracy and sonic performance. Switchable polar patterns make it extremely versatile in a variety of applications. The GXL3000BP's high sensitivity and extremely low distortion make it an ideal candidate for recording and live sound reinforcement. **Shock mount, vinyl pouch and polishing cloth included.**

**GXL3000BP .....\$204.05B**



## Studio Pack Black Pearl Chrome Finish

Includes one GXL2200BP large diaphragm cardioid condenser microphone, one GXL1200BP cardioid condenser microphone, one MH110 studio headphones, and one EPF15A pop filter. **Shock mount and mic clip included.**

**GXL2200BPS .....\$286.51B**



## USB Cardioid Dynamic Microphone

Record directly to your computer with this easy to use cardioid dynamic handheld microphone with USB output. On/off switch for quickly muting the microphone. Tripod stand and USB cable included. Use the U1 for podcasting, audio for video or recording to your favorite audio editing software. **PC and Mac compatible.** Comes with 10' USB cable & stand.

**U1 .....\$61.84B**



## USB Cardioid Condenser Studio Recording Microphone

Record directly to your computer using this large condenser microphone with USB output. Smooth, extended frequency response is excellent for singing, speech and instrument recording. -10 dB overload-protection switch minimizes distortion from loud sound sources. Bass reduction switch reduces room noise. Tripod stand and USB cable included. Use the U37 for podcasting, audio for video or recording to your favorite audio editing software. **PC and Mac compatible.** Comes with 10' USB cable & stand.

**U37 .....\$105.12B**



## 4 Piece Drum Mic Pack

Includes two D29 dynamic tom mics, one D19 dynamic snare mic, both with integrated drum clips, and one D10 dynamic kick drum mic with clip. **Protective carrying case included.**

**STAGE4 .....\$173.15B**



## 7 Piece Drum Mic Pack

Includes three D29 dynamic tom mics, one D19 dynamic snare mic, both with integrated drum clips, one D10 dynamic kick drum mic with clip, and two C9 overhead condensers with clips. **Protective carrying case included.**

**STAGE7 .....\$286.51B**



## 7 Piece Premium Drum Mic Pack

The Touring7 is an assortment of the finest percussion mics CAD offers in one premium drum microphone pack. Includes four TSM411 dynamic tom/snare mics one D12 dynamic kick drum mic, and two GXL1200BP overhead condensers. **The Touring7 comes with clips for all the mics plus four DMC-1 drum mounting clips for your toms and snare. Protective carrying case included.**

**TOURING7 .....\$430.80B**

# SENNHEISER MICROPHONES



General purpose cardioid handheld mic.  
 Frequency Response 20-20,000 Hz  
 Nominal Impedance 600 ohms  
**E825 w/switch .....\$120.00\***



Cardioid handheld vocal mic with enhanced frequency response.  
 Frequency Response 40-16,000 Hz  
 Nominal Impedance 350 ohms  
**E835.....\$150.00\***



Cardioid handheld vocal mic with enhanced frequency response.  
 Frequency Response 40-16,000 Hz  
 Nominal Impedance 350 ohms  
**E835S w/switch .....\$165.00\***



Supercardioid handheld mic that is well suited to lead vocals.  
 Frequency Response 40-16,000 Hz  
 Nominal Impedance 350 ohms  
**E845 .....\$210.00\***



Supercardioid handheld mic that is well suited to lead vocals.  
 Frequency Response 40-16,000 Hz  
 Nominal Impedance 350 ohms  
**E845S With switch .....\$225.00\***



General purpose cardioid handheld mic.  
 Frequency Response 20-20,000 Hz  
 Nominal Impedance 600 ohms  
**E815S.....\$90.00\***



Cardioid Kick drum microphone.  
 Frequency Response 20-16,000 Hz  
 Nominal Impedance 250 ohms  
**E602 .....\$240.00\***



Compact cardioid mic that is perfect for drum or instrument miking  
 Frequency Response 40-18,000 Hz  
 Nominal Impedance 350 ohms  
**E604 .....\$210.00\***



Supercardioid guitar amp mic, designed for high sound pressure level situations.  
 Frequency Response 40-18,000 Hz  
 Nominal Impedance 350 ohms  
**E609SILVER.....\$165.00\***

\*= Call for pricing

[www.sennheiserusa.com](http://www.sennheiserusa.com)

# VTECH MICROPHONES



Dynamic high impedance ball mic with cable.  
**VT1030 .....\$61.30**



Unidirectional ball mic. 600ohm Lowz impedance freq. resp: 80-12,000hz.  
**VT1040 Ball Type w/cable .....\$71.25**  
**VT1080 w/o Cord.....44.55**



The VT1050 is ideal for home and rehearsal studios or where the situation may require microphones such as drums or choirs. **This probe mic comes with a low impedance cable, clip on/off switch and carrying case.**  
**VT1050 .....\$66.75**  
**VT1090 w/o Cord .....42.60**



High Imp Mic with 10 foot attached cord on/off switch  
**VT1009 .....\$28.35**

## A/T

## MICROPHONES

## PEAVEY MICROPHONES

## MEGAPHONE



**ATR6550 Shotgun .....\$124.00B**  
**ATR6250 Stereo .....77.99B**



2 HIZ mic's w/cable and on/off switch. For entry level minded performer.  
**SDM803 Vocal .....\$36.75**



**PV®1 100 MICROPHONE**  
 Dynamic cardioid vocal microphone designed for stand-mount application. Package includes PV1 100, carrying pouch, mic clip and 6 meter mic cable. Available with XLR to XLR or XLR to 1/4" cable. POP clam shell packaging.  
**00577800 PV®1 100 Microphone – XLR w/clam shell ....\$29.99**  
**00577810 PV®1 100 Microphone – 1/4" w/clam shell.....29.99**



**VTECH**  
**VT51R 16 Watt .....\$148.80B**  
**VT62R 25 Watt w/Handheld Mic and Siren.....199.99B**



# AUDIX MICROPHONES



All purpose mic. Exceptional performance. True Hypercardioid 50Hz-16kHz Imp 250Ω ..  
**OM2** ..... **\$148.70**



Concert level performance with vocal presence boost. Very Tight Hypercardioid 48Hz-19kHz Imp 200Ω  
**OM5** ..... **\$262.70**



Lead & background vocal mic for a wide variety of applications. Cardioid 50Hz-16kHz Imp 250Ω  
**F50** ..... **\$72.65**  
**F50S** with Switch ..... **\$83.85**



Low-mid punch and warmth - Great for toms, congas, guitar cabs, sax & woodwind. True Hypercardioid 44kHz Imp 250 Ω  
**D2** ..... **\$218.00**



Great for kick, floor tom, sax, banjo, flute, bass cabs, djembe, cajon, & acoustic bass. Broad Hypercardioid 38Hz-19kHz imp 200 Ω  
**D4** ..... **\$296.25**



Pre-emphasized bass response for ground-shaking lows - Great for kick, & bass cabs. Cardioid 30Hz-15kHz imp 200Ω  
**D6** ..... **\$346.55**



**FP4** 1 snare/tom mic, 1 kick/floor tom mic, 2 tom mics ..... **\$409.85**  
**FP5** 1 snare/tom mic, 1 kick/floor tom mic, 3 rack/floor tom mics ..... **\$512.35**  
**FP7** 1 snare mic, 1 kick mic, 3 tom mics, 2 overhead condenser mics ..... **\$751.40**



**MINIATURE CONDENSER Instrument Mic**  
**F90** ..... **\$184.15**



**FLUTE**  
**ADX10FLP** ..... **\$375.75**



**HARMONICA FIREBALL** ..... **\$245.90**  
**FBALLV** w/Volume Control ..... **\$212.40**



**TENSION CLAMP** Attaches to Lugs  
**DCLAMP** Clamp ..... **\$43.70**  
**DFLEX** Dual Pivot Clamp ..... **\$27.35**  
**DCLIP** Mic Clip ..... **\$17.10**  
**DVICE** Goose Clip ..... **\$43.70**



**Miniature Instrument Microphone with Drum Rim Mount**  
 The MicroD is for professional stage and studio applications and is housed in an aluminum ring and isolated by means of a rubber shock mount system. The MicroD attaches easily and firmly to a standard drum rim utilizing the patented DVICE rim mount system.  
**MICROD** ..... **\$348.45**



**Multi-purpose Dynamic Microphone**  
 Designed with a cardioid pickup pattern for isolation and feedback control, the i5 is equipped with a VLM™ diaphragm for natural, accurate sound reproduction. The i5 is used for stage, studio and broadcast applications and can be used to mic a wide variety of musical instruments, guitars and bass cabinets as well as vocals and speech.  
**i5** ..... **\$167.70**



**DP Quad 4-piece Drum Mic Package**  
 The Audix DP Series QUAD pack is the simplest and most effective combination of microphones. With kick, snare and two overheads, the QUAD incorporates the best of two miking techniques: close miking and overhead (ambient) miking. The D6 for kick drum and the i5 for snare are considered the two microphones every drummer must have and the two ADX51 overhead mics.  
**DPQUAD** ..... **\$922.30**



**CabGrabber™**  
 Compact mic clamp for guitar amps and cabinets.  
**CABGRAB1** ..... **\$88.80**

# AUDIO TECHNICA WIRELESS



## FREQUENCY AGILE UHF SYSTEMS

- 8 selectable frequency-coordinated UHF channels
- Use up to 8 simultaneous systems-all channels compatible
- Automatic frequency scanning
- Diversity Operation for interference-resistant reception
- LED Channel display plus Antenna, AF Peak indicators
- Balanced XLR and unbalanced 1/4" output connectors
- Tone Lock™ squelch system eliminates interference when transmitter is off
- UniPak™ transmitter features: separate guitar/mic trim control, switchable high/low RF power, internal channel selector, multi-color battery/power indicator, AA operation
- Handheld transmitter features: variable trim control, internal channel selector, multi-color battery/power indicator, AA operation

**PRO501** UniPak™ System.....**\$445.70**

Select a *Wireless Essentials™* mic or cable to complete the system.

<b>PRO501G</b>	Guitar System .....	<b>469.15</b>
<b>PRO501H</b>	Headworn Microphone System.....	<b>539.50</b>
<b>PRO501L</b>	Lavalier Microphone System .....	<b>492.60</b>
<b>PRO502</b>	Handheld Microphone System.....	<b>469.15</b>
<b>PRO502</b>	Handheld Microphone Only.....	<b>328.50</b>

## IN EAR MONITOR SYSTEM



Wireless in-ear monitoring system offers 100 selectable UHF frequencies and three receiver modes: stereo, Mono, and Personal Mix Control, which gives each musician independent control of volume and mix on stage. Other features: LED indicators, 2 XLR/1/4" combo input connectors, XLR loop output (true pass-through), adjustable squelch, pilot tone, defeatable limiter, auxiliary input. Up to 10 simultaneous systems.

**M2L** L Band.....**\$936.15**

## SYSTEM 8 VHF WIRELESS SYSTEMS

- Easy operation and clear, natural sound quality.
- Reliable performance and durable construction
- Advanced dipole antenna system for extended operating range
- Power, RF, and AF Peak indicators
- Volume control, 1/4" output jack and user-adjustable squelch
- Rugged unidirectional dynamic element on handheld microphone/transmitter
- Variable microphone trim control and multi-color battery/power indicator, AA operation on transmitters
- Professional locking connector on UniPak® body-pack transmitter
- Available in 7 system configurations

**ATW801**.....**140.65**  
ATW-R800 receiver and ATW-T801 UniPak® transmitter. Select a *Wireless Essentials®* microphone or cable to complete the system.

**ATW801G**.....**164.15**  
ATW-R800 receiver and ATW-T801 UniPak® transmitter with AT-GCW guitar/instrument input cable.

**ATW801H**.....**234.50**  
ATW-R800 receiver and ATW-T801 UniPak® transmitter with PRO 8HECW headworn microphone.

**ATW801L**.....**199.35**  
ATW-R800 receiver and ATW-T801 UniPak® transmitter with omnidirectional lavalier microphone.

**ATW802**.....**164.15**  
ATW-R800 receiver and ATW-T802 handheld dynamic unidirectional microphone/transmitter. Includes AT8456a Quiet-Flex™ stand clamp.

<b>ATWT801</b>	Unipak® Transmitter Only.....	<b>93.85</b>
<b>ATWT802</b>	Unipak® Transmitter and Microphone.....	<b>117.35</b>
<b>ATWR800</b>	Receiver Only.....	<b>93.85</b>

## OPERATING FREQUENCIES

T2 – 169.505    T3 – 170.245    T8 – 171.905

## ACCESSORIES

4 Pin Hi-Z instrument/guitar cable with 1/4" phone plug. For use with Body-Pack systems.

**ATGCW**.....**\$28.15**

Connecting cable for UniPak transmitter with an XLR-type input connector, for Lo-Z microphones with XLRM-type output terminations.

**XLRW**.....**\$31.70**

**ATM350CW** Instrument Mic .....

**ATM73CW** Headworn Mic.....

**PRO92CW** Headworn Condenser Mic .....

**AT829CW** Lavalier Mic.....

# AUDIO TECHNICA WIRELESS

## FREQUENCY-AGILE TRUE DIVERSITY UHF WIRELESS SYSTEMS SERIOUS ADVANCEDS IN AFFORDABLE WIRELESS

Audio-Technica's innovative 2000 Series wireless delivers professional performance unheard of in its class. With this breakthrough series, Audio-Technica makes easy setup, automatic scanning and other advanced wireless features affordable as never before.

### ATW-2110 UNIPAK™ BODY-PACK SYSTEM

ATW-R2100 Receiver and ATW-T210 UniPak transmitter. Select a Wireless Essentials® microphone or cable to complete the system.

**ATW2110** .....\$513.80

### ATW-2120 HANDHELD SYSTEM

ATW-R2100 Receiver and ATW-T220 handheld unidirectional dynamic microphone/transmitter. Includes AT8456a Quiet-Flex™ stand clamp. **10 channels.**

**ATW2120AI** (487.125 - 506.500) .....\$584.15

**ATW2120AD** (656.125 - 678.500) .....584.15

### SUBMINIATURE WIRELESS HEADWORN MICROPHONE ONLY

MicroSet™ headworn **omnidirectional condenser** microphone terminated with 4-pin locking connector for use with A-T UniPak™ wireless systems. Ergonomic under-ear design: Flexible, lightweight metal loop hooks behind the ear for secure, comfortable fit with or without glasses. Includes two element covers, two windscreens and cable clip.

**AT892CW** Black.....\$513.80

**BP892CWTH** Flesh Tone .....513.80



*"Resellers of Audio-Technica products must be authorized by Audio-Technica, U.S., Inc. in order to advertise and sell product on the internet and otherwise. Application may be obtained by contacting salespolices@atus.com. Upon approval, reseller will receive an Authorized Internet Reseller Badge to identify them to consumers as a factory approved reseller of Audio-Technica products."*

[www.audio-technica.com](http://www.audio-technica.com)

# TELEX WIRELESS



### PERSONAL LISTENING SYSTEM

The SR-50 provides clear reception and the simplicity of a fixed channel. This economical receiver operates on one of 16 fixed narrow-band frequencies in the 72-76 MHz band. Ergonomic raised volume control knob and 1 ear bud.

**SR50I** .....\$100.00\*

**SR50J** .....100.00\*

**SR500** .....100.00\*

The SM-2 Sound Mate system is now comprised of 1) ST-200 transmitter, 4) SR-50 receivers, 4) SEB-1 earbuds, and a Soundmate wall plaque.

**SM2J** .....\$1,029.00\*

**SM20** .....1,029.00\*

### ACCESSORIES

**SEB1** Single Earbud with Cord .....\$21.00\*

### FREQUENCIES

72.1	-031	75.5	-040
72.2	-032	75.6	-041
72.3	-033	75.7	-042
72.4	-034	75.8	-043
72.5	-035	75.9	-044
72.7	-037	74.7	-045
72.8	-038	75.3	-046
72.9	-039	75.4	-047



**PH21** Telex Head Set Mic.....\$210.50B  
**WPMBK** Med Transmitter Pouch Neotech.....16.75  
**WPSBK** Sml Transmitter Pouch Neotech .....16.75

### LAPEL

**OLM10** with TA4F Plug.....\$63.00B  
**64277000** Telex WLM-50 .....198.00B  
**TC200H** Tie Bar for WLM-50 .....12.00\*

### ACCESSORIES

**CCS12** Cushion Covers .....\$7.00\*/12 pk.  
**WPMBK** Medium Transmitter Pouch Neotech.....16.75  
**WPSBK** Small Transmitter Pouch Neotech.....16.75

\* = CALL FOR DEALER COST

[www.telex.com](http://www.telex.com)

## CAD HEADPHONES



### Studio Headphones

The Sessions™ MH510 is the result of a decade long collaboration of experience and professional audio expertise. Conceptualized and designed for the accomplished performer – Studio, Live or Playback. Sound Pressure Level capability rivaling a concert experience. Four colors to choose from: Black, White/Red, Black Chrome and Black/Orange for the look and style your session deserves.

**MH510** Black .....\$142.23B  
(W) White/Red, (CR) Black/Chrome,  
(OR) Black/Orange



### Closed-Back Studio Headphones

The MH310 is a closed-back, circumaural, precision built monitor headphone. It is equipped with 50mm neodymium drivers for exceptional detail and clarity. The MH310 is designed with a self-adjusting headband for hours of fatigue free listening. **2.5 meter cord with 1/4" and 1/8" connectors included.**

**MH310** .....\$101.00B



### Studio Headphones

The CAD Audio MH110 is a circumaural, precision built monitor headphone. The MH110 is equipped with 50mm neodymium drivers offering extended frequency response while delivering exceptional detail and clarity. Designed with an easy-fold, comfort-fit headband allowing for convenient storage and hours of fatigue-free listening.

**MH110** .....\$55.65B



### Drummer Isolation Headphones

The DH100 is a high output stereo isolation headphone with extended bass frequency response. It is equipped with 50mm neodymium drivers for exceptional detail and clarity. It enables the musician to monitor music or a click track during a recording session or live performance with superior clarity while attenuating ambient noise by 19dB. **1 meter cord with 1/4" and 1/8" connectors included.**

**DH100** .....\$80.39B



### Studio Headphone Bundle

Contains four MH110 Studio Headphones and one HA4 Four Channel Stereo Headphone Amplifier.

**HP110** .....\$204.06B



**ULTIMATE LIVE SOUND OPERATOR'S HANDBOOK** – B. Gibson – Covers all aspects. Bk/DVD. ....\$39.95



**SOUND CHECK** – T. Moscal – The basics of sound and sound systems. An excellent primer for musicians, students and aspiring audio engineers. **SOUNDCHECK** .....\$14.95

## VIC FIRTH



Lightweight, non-electronic headphones which reduce overall noise levels by 22 decibels. They provide excellent protection for practice purposes.

**VFDB22** .....\$41.20B  
**VFSIH1** Stereo Isolation.....106.05  
**VFKIDP** Kidphones .....41.20B

### High Fidelity Ear Plugs

**VFEP** Regular Size .....\$29.99 pr.  
**VFEP** Large Size .....29.99 pr.

## HOSA



Economically priced headphones.

**HDC800** Hosa Dynamic .....\$65.40  
**HDS100** Closed cup.....22.45  
**KM16310** Wall Mount Holder .....25.00

## SENNHEISER



**HD201** Circumaural closed .....\$29.95\*  
**HD202** Semi-circumaural closed .....\$34.95\*

## PEAVY HEADPHONES



### PVH11

03012230

Dynamic, closed-back design. 40mm speaker driver. High-energy neodymium magnet. Patented self-adjusting soft rubber head pad construction. 2 meter cable. Stereo 3.5mm cable connector. Optional 1/4" adapter.

**03012480** .....\$24.99B

### PVH45

Professional dynamic headphones. Leatherette ear pads. 2 meter cable. Stereo 3.5mm cable connector. Includes 1/4" adapter. Distinctive clam shell packaging.

**03012230**.....69.99B

## MICROPHONE CASES

### PEAVY



**SKB**  
**SKB1200** 12 hole case....\$284.99  
**MTS**  
**1620V** 6 hole case.....125.65



Padded mic bags with accessory pouch, includes Peavey logo luggage tag for easy identification.

**PEAVY**  
**03011860** 6 Space  
Mic Bag.....\$39.99B  
**03011870** 12 Space  
Mic Bag.....49.99B



**KACES**  
**KPMB6** 6 hole Bag.....\$45.85

# KOSS STEREOPHONES



Frequency Response: 20-20,000 Hz. Pneumalite earcushions. Adjustable headband. Volume Control.  
**KPH25K** .....\$14.99B



Frequency Response: 18-20,000 Hz. Pneumalite earcushions for improved bass. Pivoting earpads and earplates for maximum comfort.  
**UR10** Closed Back .....\$9.99\*



Home stereophone with closed ear cushion design, adjustable padded headband and surround sound circuit.  
**PRO4AA** .....\$99.99\*



Lightweight home or portable design (7.3 oz.). Ideal for TV, VCR or CD use. Pneumalite™ Earcushions for better bass and comfort.  
**KSC17** Behind Ear w/VC.....\$14.99\*



Lightweight, home stereophone with foam ear cushion design and adjustable headband.  
**SB40** With Mic .....\$39.99\*



High energy for full frequency and dynamic sound. Foam earcushions for comfortable, hear-through sound.  
**KCS80** With Mic.....\$29.99\*



The KPH7 on ear headphone is equipped with dynamic elements for an extended frequency response. It features an over the head design with contemporary style. Perfect for use with portable MP3 players or iPods. Maximum portability with a lightweight design. 4 foot cord and 3.5mm plug.  
**KPH7** .....\$5.99



Bass-enhanced, high quality sound. Enhanced rigidity minimizes mechanical distortion, yielding a full frequency response. Great volume, even with low-voltage portable devices. Ear cushions seal comfortably around ears, improving bass performance and blocking outside noise while preventing sound leakage. Earcups collapse down into a compact, protective package for easy storage and travel. Includes gold-flashed 3.5mm (1/8 inch) plug and gold-flashed 6.3mm (1/4 inch) adapter.  
**UR29** .....\$29.99\*



Lightweight portable Stereophones with adjustable headband. In-line volume control and open, hear-through sound. Straight 4-foot dual-entry cord and 3.5mm plug with 6.3mm adapter. Titanium layered diaphragm delivers accurate sound reproduction. Frequency response delivers high quality sound performance. Perfect for at-home and portable use.  
**KTXPRO1** .....\$19.99\*



High fidelity clip headphones. Exceptionally wide frequency response. Computer-optimized neodymium, iron, and boron rare-earth magnet structures deliver amazing clarity at any volume. Include a straight, dual entry, 4 foot cord with gold-flashed 3.5 mm (1/8") plug. Pivoting clips promise accommodating fit. Enjoy greater volume despite low-voltage portable devices.  
**KSC75** .....\$19.99\*



Leatherette ear cushions form seal around ears to enhance bass frequencies. Headband accommodates all head shapes and sizes for maximum comfort. Includes straight, dual-entry 8 foot cord with 3.5mm (1/8 inch) plug. Folds into compact configuration, convenient for storage and portability.  
**UR18** .....\$19.99\*



Extended frequency response, improved signal transmission and conduction for cleaner, clearer sound. Ear cushions guarantee an open, hear-through sound. Pivoting ear plates provide a better fit than most clips. Includes a straight, dual-entry 4 foot cord with 3.5mm (1/8 inch) plug.  
**KSC21** .....\$9.99\*

(\* CALL FOR COST)

# AUDIO TECHNICA HEADPHONES



**ATHM30**  
Closed-back  
20-20,000 Hz  
Neodymium  
100dB SPL  
650 ohms  
**\$91.50**



**ATHM10**  
Closed-back  
20-22,000 Hz  
Ceramic  
100 DBL  
32 ohms  
**\$58.65**



**ATHM2X**  
Open-back  
20-20,000 Hz  
Samarium Cobalt  
100 dB SPL  
4-16 ohms  
**44.45**



**ATHM3X**  
Closed-back  
20-21,000 Hz  
Samarium Cobalt  
100 dB SPL  
4-16 ohms  
**\$58.55**



**ATHM20**  
Closed-back  
30-20,000 Hz  
Neodymium  
98 dB SPL  
40 ohms  
**\$82.10**



Choose the mono ATH-COM1 for one-ear monitoring, or the ATH-COM2 with dual-earphone stereo sound and enhanced operator isolation. Both have neodymium dynamic microphones for crisp, accurate vocal pickup.

**ATHCOM1** .....**\$70.25**  
**ATHCOM2** .....**82.00**



**ATHP1** .....**\$21.10**  
Open-back dynamic, 28 mm diameter drivers, 3.3' (1 m) cable with 3.5 mm stereo mini-plug.



**ATHP3** .....**\$25.80**  
Open-back dynamic, 40 mm diameter drivers, 3.3' (1 m) cable with 3.5 mm stereo mini-plug.



**ATHP5** .....**\$32.85**  
Open-back dynamic (Neodymium), 40 mm diameter drivers, 3.3' (1 m) cable with 3.5 mm stereo mini-plug.



## SWIRLYHOOK

**SH1000** Single hook .....**\$10.99**  
**SH2000** Single hook .....**38.99/4 pk.**  
The SwirlyHook is built to fit on roughly half-inch tubing. Try it on mic stands, drum hardware, etc. The SwirlyHook will hold headphones, tambourines, cables! Made in the USA of coiled spring steel and PVC.

## HEADPHONE HOLDERS

Clamps to Stand.  
**HAP** .....**\$8.45**

## KÖNIG + MEYER

Wall Mount for 2 pair.  
**KM16310** .....**\$24.99**

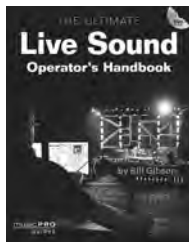

**ULTIMATE LIVE SOUND OPERATOR'S HANDBOOK** – B. Gibson – Covers all aspects. Bk/DVD.  
.....**\$39.95**



**SOUND CHECK** – T. Moscal – The basics of sound and sound systems. An excellent primer for musicians, students and aspiring audio engineers.  
**SOUNDCHECK** .....**\$14.95**



Audio-Technica's newly designed ANC7B Quiet-Point closed back headphones are designed for use with MP3, CD, DVD and in-flight entertainment systems, as well as all Apple™ products. **Accessories included:** Deluxe carrying case 6.3mm stereo and airline adapter, AAA battery and accessory pouch.

**ATHANC7B** .....**\$329.49**



Closed-back dynamic DJ monitor headphones, 40 ohms; 40 mm drivers with neodymium magnet systems and CCAW voice coils; 3.5 mm stereo connector with 1/4" adapter.  
**PRO500MK2** .....**\$320.89**

[www.audio-technica.com](http://www.audio-technica.com)

# YAMAHA HEADPHONES



**YRH1C** .....**\$20.00**  
Lightweight foam ear cushions that provide the utmost in comfort.

**YRH2C** .....**32.00**  
Pivoting foam ear cushions.

**YRH3C** .....**48.00**  
The RH3 model is equipped with high-power magnetic neodymium for maximum detail and clarity.



**YRH5MA** .....**\$80.00**  
These headphones are the semi-open dynamic stereo type.

**YCM500** .....**80.00**  
This headset is perfect for the player who wants to sing while playing an instrument.



## IN EAR

**YEPH20G** Green .....**\$39.95**  
**YEPH30W** White .....**49.95**  
**YEPH50W** White .....**99.95**  
**YEPH20BB** Brown Berry .....**39.95**  
**YEPH20BK** Black .....**39.95**  
**YEPH20IB** Indigo Blue .....**39.95**  
**YEPH20PI** Pink .....**39.95**  
**YEPH30BK** Black .....**49.95**

# EMINENCE SPEAKERS

## PRO AUDIO



## GUITAR



## BASS



NO.	MODEL	SIZE	IMP.	POWER	PRICE
ALPHA6A	Alpha-6A	6"	8 ohm	100W	\$63.20B
ALPHA8A	Alpha-8A	8"	8 ohm	125W	68.45B
BETA10A	Beta 10A	10"	8 ohm	150W	89.50B
BETA15A	Beta 15A	15"	8 ohm	300W	97.40B
BETA8A	Beta 8A	8"	8 ohm	125W	84.25B
BETA12A	Beta 12A	12"	8 ohm	250W	86.85B
COPPERHEAD	Patriot	10"	8 ohm	75W	94.75B
D2510	Deltalite II 2510	10"	8 ohm	250W	171.10B
D2512	Deltalite I 2512	12"	8 ohm	250W	176.35B
D2515	Deltalite II 2515	15"	8 ohm	300W	223.70B
DELTA10A	Delta 10A	10"	8 ohm	350W	100.00B
DELTA10B	Delta 10B	10"	16 ohm	350W	100.00B
DPRO12A	Delta Pro 12A	12"	8 ohm	400W	165.80B
DPRO15A	Delta Pro 15A	15"	8 ohm	400W	181.60B
DELTA12A	Delta 12A	12"	8 ohm	400W	97.40B
DELTA12B	Delta 12B	12"	16 ohm	400W	97.40B
DELTA15A	Delta 15A	15"	8 ohm	400W	107.90B
DELTA15B	Delta 15B	15"	16 ohm	400W	107.90B
D15LFA	Delta 15 LFA	15"	8 ohm	500W	110.55B
D4012HO	Definmax 4012HO	12"	8 ohm	600W	276.35B
D4018LF	Definmax 4018LF	18"	8 ohm	800W	302.65B
EJ1250	EJ1250 (Eric Johnson)	12"	8 ohm	50W	384.20B
EJ125016	EJ125016 (Eric Johnson)	12"	16 ohm	50W	384.20B
K3015	Kappalite 3015	15"	8 ohm	450W	281.60B
K3012LF	Kappalite 3012LF	12"	8 ohm	450W	252.65B
K3015LF	Kappalite 3015LF	15"	8 ohm	450W	281.60B
KPRO10A	Kappa Pro-10A	10"	8 ohm	500W	134.25B
KPRO12A	Kappa Pro-12A	12"	8 ohm	500W	176.35B
KPRO15A	Kappa Pro-15A	15"	8 ohm	500W	192.15B
K15LF2	Kappa Pro-15LF2	15"	8 ohm	600W	202.65B
K15LFA	Kappa 15LFA	15"	8 ohm	600W	155.30B
K15A	Kappa 15A	15"	8 ohm	450W	136.85B
OPRO15A	Omega Pro-15A	15"	8 ohm	800W	239.50B
OPRO18A	Omega Pro-18A	18"	8 ohm	800W	265.80B
S18A2	Sigma Pro-18A2	18"	8 ohm	650W	221.10B
KILPRO15A	Kilomax Pro 15A	15"	8 ohm	1250W	268.45B
KILPRO18A	Kilomax Pro-18A	18"	8 ohm	1250W	323.70B
MANOWAR	Man o War	12"	8 ohm	120W	105.30B
MAVERICK	Maverick	12"	8 ohm	1250W	165.80B
GOVERNOR	The Governor	12"	8 ohm	75W	115.80B
GOVERNOR16	The Governor 16	12"	16 ohm	75W	115.80B
LILBUDDY	Lil Buddy	10"	8 ohm	75W	97.40B
LSV12	Lynch Super V12	12"	8 ohm	75W	142.10B
PIACK	Private Jack	12"	8 ohm	50W	102.65B
PIACK16	Private Jack 16	12"	16 ohm	50W	102.65B
REDFANG	Red Fang	12"	8 ohm	30W	339.50B
REDFANG16	Red Fang 16	12"	16 ohm	30W	339.50B
RWB	Red/White & Blues	12"	8 ohm	120W	102.65B
SWAMPTHANG	Swamp Thang	12"	8 ohm	150W	123.70B
STHANG16	Swamp Thang 16	12"	16 ohm	150W	123.70B
TEXASHEAT	Texas Heat	12"	8 ohm	150W	107.90B
THEAT16	Texas Heat 16	12"	16 ohm	150W	107.90B
WIZARD	The Wizard	12"	8 ohm	75W	121.10B
WIZARD16	The Wizard 16	12"	16 ohm	75W	121.10B
CREX	Can/Rex	12"	8 ohm	50W	100.00B
CREX16	C/Rex 16	12"	16 ohm	50W	100.00B
TONKER	The Tonker	12"	8 ohm	150W	115.80B
TONKER16	Tonker 16	12"	16 ohm	150W	115.80B
RAGINCAJUN	Ragin Cajun	10"	8 ohm	75W	94.75B
L1058	Legend 1058	10"	8 ohm	75W	73.70B
L1258	Legend 1258	12"	8 ohm	75W	78.95B
REIGNMAKER	Reignmaker	12"	8 ohm	75W	150.00B
LB102	Legend B102	10"	8 ohm	200W	118.45B
LGB128	Legend	12"	8 ohm	50W	78.95B
LCB15	Legend CB15	15"	8 ohm	300W	171.10B
LBP102	Legend BP102	10"	8 ohm	200W	92.15B
LBP1024	Legend BP1024	10"	4 ohm	200W	92.15B
IMPERO12A	Impero 12A	12"	8 ohm	1100W	328.90B
IMPERO15A	Impero 15A	15"	8 ohm	1200W	339.50B
IMPERO18A	Impero 18A	18"	8 ohm	1200W	357.90B
BLS2012	BassLite S2012	12"	8 ohm	150W	134.25B

## EMINENCE SPEAKERS



NO.	MODEL	SIZE	IMP.	POWER	PRICE
<b>P620H</b>	Patriot 620H	6"	4ohm	20 watt	<b>73.70B</b>
<b>RAMROD</b>	Red Coat	10"	8ohm	75 watt	<b>97.40B</b>
<b>L1518</b>	Legend 1518	15"	8ohm	150 watt	<b>105.30B</b>
<b>CV75</b>	Red Coat	12"	8ohm	75 watt	<b>102.65B</b>
<b>LEM12</b>	Legend EM12	12"	8ohm	200 watt	<b>200.00B</b>
<b>LA10850</b>	LA10850	10"	8ohm	350 watt	<b>152.65B</b>
<b>LA12850</b>	LA12850	12"	8ohm	800 watt	<b>210.55B</b>
<b>LA15850</b>	LA15850	15"	8ohm	800 watt	<b>244.75B</b>
<b>KPRO15B</b>	Kappa Pro 15B	15"	16ohm	500 watt	<b>192.10B</b>
<b>DPRO12450A</b>	Delta Pro 12-450A	12"	8ohm	357 watt	<b>128.95B</b>
<b>KPRO10LF</b>	Kappa Pro 10LF	10"	8ohm	600 watt	<b>178.95B</b>
<b>KPRO15LFC</b>	Kappa Pro 15LFC	15"	4ohm	600 watt	<b>202.65B</b>
<b>L1275</b>	Legend 1275	12"	8ohm	75 watt	<b>76.35B</b>
<b>GASC64</b>	George Alessandro	12"	8ohm	40 watt	<b>102.65B</b>

## EMINENCE TWEETER, DRIVERS, FLARES



<b>APT80</b>	3.4" x 3.4" Tweeter.....	<b>\$36.85B</b>
<b>APT150</b>	7.5" x 4.5" Tweeter.....	<b>36.85B</b>
<b>ASD1001S</b>	1" Throat, 8 ohm, screw on driver, 50W.....	<b>34.25B</b>
<b>NSD200516</b>	1" Throat, 16 ohm, bolt on driver, 50W.....	<b>126.35B</b>
<b>NSD2005S8</b>	1" Throat, 8 ohm, screw on driver, 50W.....	<b>165.80B</b>
<b>NSD2005S16</b>	1" Throat, 16 ohm, screw on driver, 50W.....	<b>165.80B</b>
<b>PSD20028</b>	1" Throat, 8 ohm, bolt on driver, 80W.....	<b>76.35B</b>
<b>PSD200216</b>	1" Throat, 16 ohm, bolt on driver, 80W.....	<b>78.95B</b>
<b>PSD2002S8</b>	1" Throat, 8 ohm, screw on driver, 80W.....	<b>81.60B</b>
<b>PSD2002S16</b>	1" Throat, 16 ohm, screw on driver, 80W.....	<b>78.95B</b>
<b>PSD20138</b>	1" Throat, 8ohm, Bolt on Driver, 85W.....	<b>100.00B</b>
<b>PSD201316</b>	1" Throat, 16ohm, Bolt on Driver, 85W.....	<b>100.00B</b>
<b>PSD2013S8</b>	1" Throat, 8ohm, Screw on Driver, 85W.....	<b>100.00B</b>
<b>PSD2013S16</b>	1" Throat, 16ohm, Screw on Driver, 85W.....	<b>100.00B</b>
<b>PSD30148</b>	1.4" Throat, 8ohm, Bolt on Driver, 100W.....	<b>244.75B</b>
<b>PSD301416</b>	1.4 Throat, 16ohm, Bolt on Driver, 100W.....	<b>244.75B</b>
<b>PSD30068</b>	2" Throat, 8 ohm, bolt on driver, 80W.....	<b>213.15B</b>
<b>P8DIA</b>	Diaphragm.....	<b>50.00B</b>
<b>P16DIA</b>	Replacement diaphragm for PSD200216, PSD2002S16.....	<b>50.00B</b>
<b>SST1</b>	1" Throat, 9.8" x 7.7" x 5.2" flare.....	<b>57.90B</b>

## JOHNSON LOUDSPEAKERS

<b>JC008</b>	8", 8 ohm, 100 watt rms, 33Hz-6kHz.....	<b>\$27.60</b>
<b>JC010</b>	10", 8 ohm, 150 watt rms, 37Hz-5.6kHz.....	<b>40.10</b>
<b>JC012</b>	12", 8 ohm, 200 watt rms, 39Hz-5kHz.....	<b>59.80</b>
<b>JC015</b>	15", 8 ohm, 250 watt rms, 3Hz-3kHz.....	<b>117.70</b>

## VHT SPEAKER

### VHT CHROMEBACK 12" SPEAKERS

Chrome-plated Frame and Back Plate, 50-ounce Magnet, 1.75" Voice Coil.		
<b>AVCB</b>	12, 16 ohm, 60 watt rms.....	<b>\$124.90</b>



# MICROPHONE ACCESSORIES

## GOOSENECKS

Flexible chrome-plated goosenecks, available in three lengths.



<b>MGN06</b>	6"	.....	<b>\$9.75</b>
<b>MGN13</b>	13"	.....	<b>12.60</b>
<b>MGN19</b>	19"	.....	<b>15.30</b>
<b>MGN6BK</b>	6" Black	.....	<b>9.75</b>
<b>MGN13BK</b>	13" Black	.....	<b>12.60</b>
<b>MGN19BK</b>	19" Black	.....	<b>15.30</b>
<b>GN19E</b>	19" Black	.....	<b>21.25</b>

## ON/STAGE GOOSENECK

<b>MSA903006B</b>	6" Black	.....	<b>8.99 ea.</b>
<b>MSA903006C</b>	6" Chrome	.....	<b>8.99 ea.</b>
<b>MSA903013B</b>	13" Black	.....	<b>11.99 ea.</b>
<b>MSA903013C</b>	13" Chrome	.....	<b>11.99 ea.</b>
<b>MSA903019B</b>	19" Black	.....	<b>13.99 ea.</b>
<b>MSA903019C</b>	19" Chrome	.....	<b>13.99 ea.</b>

## RUBBER NECK SOLID CORE

Rubber coated, no creak solid core gooseneck.

<b>R10ST</b>	10"	.....	<b>\$21.00B</b>
<b>R16ST</b>	16"	.....	<b>23.25B</b>
<b>R20ST</b>	20"	.....	<b>27.00B</b>



## L SERIES

11" hollow core with XLR & threaded female on opposite ends.

<b>R11L</b>	.....	<b>\$39.95B</b>
17" hollow core with XLR & threaded female on opposite ends.		
<b>R17L</b>	.....	<b>\$43.15</b>



## THE ORIGINAL SWIRLYGIG

Intended for use on half-inch tubing, the Original SwirlyGig fits snugly on a standard mic stand. It is made out of resilient spring steel, then coated in protective PVC for grip and durability, in black.

<b>SG1000</b>	.....	<b>\$14.99</b>	
<b>SG2000</b>	1" Tube	.....	<b>14.99</b>
<b>SK8020</b>	1 1/4" Tube (Skiffdaddy)	.....	<b>14.99</b>



**MSA5050** Clamp on Drink Holder, On/Stage

..... **\$25.99**



**TM1** ..... **\$41.25B**

Twin Mount. Designed for horizontal mounting of two or three microphones on any stand or podium-top installation. Fits all 3/8"-27 thread microphones. 8 3/4" wide; chrome finish.

## ON-STAGE

**MY700** Deluxe Stereo Mic Attachment Bar, holds up to six microphones ..... **\$40.99**

**MY550** 6" Mic Extension Bar ..... **20.99**



Adaptor, 3/8" male to 3/8" female. Chrome.

**W374** ..... **\$4.95**

Adaptor, 3/8" female to 3/8" male. Chrome.

**W371** ..... **\$4.15**



**DS5** ..... **\$33.75B**

General Purpose Stand. Non-adjustable 4" high chrome tube. 6" dia. cast iron charcoal base. Weight: 2 lbs.

**MS301** ..... **\$16.25**



**DS14** ..... **\$58.75B**

Contemporary Stand. For professionally styled microphones. Non-adjustable 3" high chrome tube. Charcoal base. Weight: 2 lbs.



**L02B** ..... **\$33.75B**

Lock-On Accessory. Protective locking design with push-button release for instantaneous fastening or disconnect of microphone-holder or boom attachment from any stand. Chrome finish.

## ON/STAGE QUICK RELEASE MIC ADAPTER

Interchange all of your favorite mics and mic clips with the push of a button! This push button quick release device eliminates cross-threading. A rubber washer acts as a shock absorber. This model is made from solid brass.

**QK2B** ..... **\$24.99**

## PRO CADDY RAX



Pro Caddy Rax easily attaches to any drum, cymbal, hi-hat stand, mic stand, or music stand. Holds cup, can, or bottle, and towel.

**PCR1** Fits Med. Diameter Stands ..... **\$12.98**

**KM1602BK** Drink Holder, Black ..... **20.00**

## WRAP N STRAP



## CABLE TIES

**900M** 6 - 9" Asst. .... **\$10.00**

**906M** 6 - 6" Asst. .... **9.00**

**906E** 5 - 6" Blue, Yellow ..... **7.00**

**912M** 6 - 12" Asst. .... **12.00**



**DS7200B On/Stage** ..... **\$22.99**  
Black Adjustable 9"-13", 6" Base, Desktop

**DS300B On/Stage** ..... **36.99**  
Posi-Lok™, Mini Boom 7" Black, 6" Base, Desktop

**MS302** Chrome, Adjustable 8"-13" ..... **\$39.40**

**MS303** Large Base Chrome, Adjustable 9 1/2"-15" ..... **33.50**

**KB815M** Tripod Table Top Mic Stand, Hamilton ..... **\$22.99**

**KB816M** Offset Mic Adaptor, Hamilton ..... **8.99**



## MIC CADDY

Drink, Accessory and CD holder.

**MC** ..... **\$34.65**

**MSDDT** ..... **24.00**

## SHEET MUSIC HOLDER

**MSSS** Clamps to Stand ..... **\$25.50**

## GUITAR HOLDER

**KM16150** ..... **\$35.99**



Microphone desk stand. Plastic base with nickel plated folding legs.

**KB810** w/bag & clip ..... **\$14.99**

## CABLE WRAP

**CWK** ..... **\$7.95**  
6' velcro strip, cut to length.

## CABLE TIES

**KK4** ..... **\$4.05**

Package of six velcro cable ties.

## WEDGIE

**WESR001** ..... **\$3.00**

## CABLE WRAP HOSA

Package of five velcro cable ties, 8" long.

**WT1148** ..... **\$4.75**

**WT1148G** w/Slot ..... **5.95**

## CABLE CLIPS

Pack of 6 clips cord to stand.

**SFCC** ..... **\$8.40**

## GAFFER TAPE HOSA

**GFT447B** 2" x 180' ..... **\$26.65**

## CABLE LABELS HOSA

**LBL466** 60 Peel & Stick ..... **\$10.65**

# ATLAS STANDS & ACCESSORIES

- MS10C** "Leader" Stand .....\$81.25B
- MS10CE** "Leader" Stand; Ebony .....73.75B
- MS12CE** Low-Profile; Ebony .....78.75B
- MS20** Heavy Duty Stand; Low .....181.25B  
Contour Ebony Finish Base
- MS20E** Ebony MS-20 .....173.75B
- XX865** Bumper Foot .....1.50B



High caliber design of the new Atlas Performer Series is more than just a boom to hang your mic on. It combines upbeat styling with an all-metal CAD engineered swivel clamp to offer the greatest in user appearance and flexibility.

- PB15E** 34" L, Black .....\$83.75B
- PB21X** 25 1/4" - 38 1/2"L, Chrome .....108.75B
- PB21XE** 25 1/4" - 38 1/2"L, Ebony .....101.25B



- |               |           |          |                |
|---------------|-----------|----------|----------------|
|               | Height    | Base     | Boom           |
|               | Span      | Spread   | Length         |
| <b>SB-36W</b> | 48" - 72" | 15" Tri. | 62"            |
| <b>SB36W</b>  | w/ Wheels |          | .....\$628.75B |

- AD-4B** .....\$11.25B  
3/4" long, 5/8"-27 male running thread.
- AD-5B** .....11.25B  
5/8"-27 female to 5/8"-27 female, coupling.
- AD-7B** .....11.25B  
3" long tube, 5/8"
- AD-8B** .....13.75B  
6" long tube, 5/8"
- AD-11B** .....16.25B  
Flange, 5/8"-27 female.
- AD11BE** .....13.75B
- AD-12B** .....16.25B  
Chrome Flange, 5/8"-27 male.
- SF8040** .....8.40
- TM02B** .....7.99 ea.  
Male Flange Mount, Black, On-Stage
- TM02C** .....7.99 ea.  
Male Flange Mount, Chrome, On-Stage
- AD-12BE** .....13.75B  
Black version
- SF8040BK** .....8.40B
- AD-19B** .....31.25B  
45° angle tube; 5/8"-27 male and female end.
- MSC-K** .....38.75B  
Blister packaged service parts kit for all 7/8" clutch assembly stands. Includes clutch, lock rings, inserts.



- PB11XEB** .....\$98.75B  
Horizontal boom extension for DMS-10E stand provides variable length positioning for optimum microphone placement. Ebony finish. 15 1/2"-22"
- DMS-10E** .....\$73.75B  
Professional drum miking accessory features adjustable height, low profile design for accurate positioning and circular cast iron base to isolate microphone from drum vibrations. Ebony finish. 14 1/2"-26 1/4"
- DMS7E** .....\$66.25B  
Ebony finish. Adjusts from 8"-13"
- DS7** .....\$51.25B  
Adjustable Desk Stand. Chrome tube assembly adjustable height 8" to 13". Grip-action clutch. 6" dia. charcoal base. Weight: 3 lbs.

# ON/STAGE MICROPHONE STANDS

- Round Base Mic Stand**  
Black finish. Steel mid-point locking clutch. 5/8" - 27 solid threaded upper shaft w/locking washer. Height adjustment range: 33" to 60"  
Base diameter: 10"  
Weight: 7 lb.
- MS7201B** Black .....\$39.99
- MS7201C** Chrome .....44.99

- Heavy-Duty Euro-Boom Microphone Stand**  
The MS901B+ adds a 30" boom, which features an oversized angle adjustment knob for and a non-slip clutch for secure positioning. A solid steel 5/8"-27" threaded lug.  
Height adjustment range: 36" to 64"  
Boom length: 30"  
Base spread: 24"  
Leg housing: Steel
- MS9701B+** .....\$88.99

- Telescoping Euro Boom Microphone Stand**  
The Euro Boom boasts hybrid sheet metal and composite leg housing, making it unbreakable and lightweight! A telescoping boom arm.  
Height adjustment range: 36" to 63"  
Boom adjustment: 19" to 33"  
Base spread: 23"  
Leg housing: Metal
- MS7701TB** Black .....\$72.99

# MIKING STANDS & BOOMS

- Quik Lok**  
Short, tripod with telescopic boom. Black. Height adjustment range: 16.5" to 19.25" • Boom length: 22" to 40" • Diameter of leg spread: 21.3" • Folded height: 22.4" • Weight: 3.1 lb.
- AMSA341BK** .....\$39.99

- Desk top stand with heavy duty base. Easy height adjustment for miking any size bass drum.**
- UPCMSB** .....\$78.00

- Euro Boom Microphone Stand**  
Steel midpoint locking clutch. Height adjustment range: 32" to 62"  
Boom length: 30"  
Base spread: 24"
- MS7701B** Black .....\$53.99

- Heavy-Duty Tripod Base Microphone Stand**  
Improved features include extra-thick steel shafts, ergonomically designed and anodized machined aluminum center clutch, steel leg housing with adjustable heavy-duty leg mounts.  
Height adjustment range: 36" to 64"  
Base spread: 24"  
Leg housing: Steel
- MS9700B+** Black .....\$68.99

- Kick Drum/Amp Tripod with Boom**  
The MS7411B features a folding tripod base, die-cast steel height adjustment clutch, all metal boom clutch and steel boom and counterweight.  
Height adjustment range: 17" to 27"  
Boom length: 32"  
Base spread: 26"
- MS7411B** Black .....\$52.99

# MICROPHONE STANDS



## ROUND, BASE

- MS603B** Black.....\$37.99
- MS603C** Chrome.....\$39.99

## ON STAGE

- MS7201B** Black On Stage.....\$39.99
- MS7201C** Chrome On Stage .....44.99
- MSB6500** Heavy-Duty Microphone Stand, bag holds 3 stands, On Stage ....64.99
- MS7325** Stackable Round Base Mic Stand, On/Stage .....49.99



## TRIPOD BASE

- MS203** Chrome.....\$38.25
- MS203B** Black .....39.99
- KB820** Black, 27"-62" .....23.99



## TRIPOD BASE WITH BOOM

- MS205B** Black with Boom .....\$57.90
- KB840M** Black Fix Boom, Hamilton .....49.99
- KB845M** Black Boom Adjusts 30" - 46", Hamilton.....53.99
- KB858M** Mic & Boom Stand Bag, Hamilton .....17.99



- MST140** Black .....\$43.00
- MSCSI** Black with Boom .....61.80

## TRIPOD BASE/STUDIO BOOM MIC STANDS

- MS7700B** Euro-Style Tripod Base Mic Stand, On Stage.....\$36.99
- SB9600** Tripod Studio Boom Mic Stand, On Stage .....216.99
- SMS7650** Hex-Base Studio Boom Mic Stand, On Stage .....296.99



## QUIK LOK

- AMSA50** Tripod Studio Boom .....\$199.99
- AMSA188** Tripod Desktop Mic Stand .....26.65
- AMSA341BK** Tripod w/Boom, Low .....39.99
- AMSA498BK** Round Base Mic Stand.....66.65
- AMSA300BK** Black with Boom .....53.32

# BOOM ARMS



## TELESCOPING

- KM2112B** Black, AKG, 17-33" .....\$58.80B
- BS4B** Black, 32-54" .....25.00
- MB621** Chrome, 20-35.5" .....42.50
- MSA7020TB** Black Telescoping Boom 32"-48", On Stage .....24.99
- MSA7040TB** Black Telescoping Boom 19"-32", On Stage .....29.99

## NON-TELESCOPING

- BS2B** Black .....\$24.99
- BS2** Chrome .....24.99
- MSA7020B** 32" Top Mnt Boom, On Stage ..21.99
- MBP7000** Handheld Mic Boom Pole, On Stage.....86.99

# ON/STAGE MICROPHONE STANDS



## KICK DRUM/AMP MICROPHONE STAND

- A heavy, casted tripod base gives this stand the stability of much larger models, while its compact shape makes for easy positioning in those tight on stage spaces.
- Height adjustment: 14" to 22"  
 Boom length: 17.5"  
 Base spread: 11"
- MS7311B** .....\$52.99



## BASS DRUM/BOOM COMBO

- This variation of the MS7311B features a U-shaped base instead of the heavy tripod design, allowing for placement in the tightest of spaces.
- Boom length: 16"  
 Midpoint clutch  
 Height adjustment: 8" to 14"  
 Black finish
- MS7920B** .....\$47.99



## POSI-LOK™ MINI BOOM DESKTOP STAND

- This innovative Posi-Lok™ clutch on this stand features 52-locking teeth and an ergonomic knob. The 7" mini boom is perfect for announcements, paging, dispatch and court house use. The solid sand-cast base with five rubber feet adds stability.
- Boom length: 7"  
 Base diameter: 6"  
 Base weight: 2 lbs.
- DS300B** .....\$36.99

# PEAVEY® STANDS



## BLACK ROUND BASE MIC STAND

Round-base mic stand with cast-iron base. Steel tube with customized twist-grip, height adjusting clutch. Minimum height 33½", maximum height 61".

00723350 .....\$35.42



## BLACK V-BASE MIC STAND

No-thread, no-strip, friction-type clutch won't wear out and allows for easy one-hand height adjustment. Special "V" shaped base allows for easy positioning around drum stands and effects pedals. Space-saving "stackable storage." Stand slightly tilts toward the performer, reducing the need for a boom arm stand. Minimum height 37", maximum height 66".

00051540 .....\$87.49 pr.



## TABLETOP MIC STAND

6" black powder coat base. Chrome shaft with adjustment clutch. Height adjustment from 7" to 12.5".

00394500 .....\$16.29



## BOOM ARM

Permits convenient positioning of a microphone from 16" to 32½" from the stand pole. Vertical angle is adjusted by a large, comfortable knob which actuates a smooth elastomer clutch for easy, accurate setup every time.

00370800 Black.....\$24.99

00715130 Chrome.....\$24.99



## PEAVEY SPEAKER STAND BAG

Black nylon bag with handle and shoulder carrying strap. Holds two S-I stands or two black speaker stands with a divider for stand protection. Two Velcro straps to hold stand in place.

00385160 Speaker Stand Bag.....\$44.99



## BLACK TRIPOD MIC STAND WITH BOOM

Heavy duty, all-metal, fully adjustable tripod stand. Rubber feet prevent skidding. Nylon leg mounts for longer life. Clutch handle and all adjustment handles are metal. Boom adjusts from 34" to 53". Minimum stand height 39", maximum stand height 53".

00722910 .....\$64.99



## COMBO AMP STAND

Black finish. Reversible cradle will hold a combo amplifier at the optimum angle to be heard on stage. Cradle can be reversed to a less severe angle to hold bass combos, cabinets, keyboards, small mixers, and lighting consoles. Weight capacity 50 lbs.

00722880 .....\$72.49



## BLACK SPEAKER STAND

Locking safety pin and nylon-reinforced collars. 100 lbs. maximum load capacity. Black powder coat finish. Equipped with reversible center pole to accommodate 1¾" and 1½" speaker cabinet flange adapters. Increased footprint for better stability and weight capacity. Rubber feet to reduce lateral movement along the floor.

03007580.....\$99.99B ea.

50 lbs. maximum load capacity, minimum height 72", all the rest same as the above stand.

03007570.....\$67.49 ea.



## VERSAMOUNT™ 70 PLUS

Mounting bracket can be used with the Stadia™II, Stadia IIT, Impulse® 200/1012/PR12, Impulse 500/1015/PR15, Impulse 100/PR10, SSE 15, SSE 12, and SSE 10 cabinets.

03011050 Versamount 70 Plus (Blk) ...\$124.99 ea.

03011040 Versamount 70 Plus (Wht)....\$124.99 ea.



## VERSAMOUNT™ 35

Ceiling bracket can be used with the Impulse 6, Impulse 6T, Impulse 652S, Impulse 7, SSE-26 and Impulse 100 cabinets. Available in black or white finish.

00124170 Versamount 35 (Blk) .....\$54.99 ea.

00477970 Versamount 35 (Wht).....\$54.99 ea.

# HERCULES MIC STANDS



Low Profile H Base  
Height: 11"-17.5", Weight: 3.5 lbs.  
**MS100B.....\$53.99**



Low Profile H Base with Short Arm  
Great for drum or amp mics in situations where floor space is limited.  
Height: 17.3", Boom Length: 17.3"-31.5", Weight: 6.6 lbs.  
**MS120B.....\$83.99**



H Base Stand  
Cast base, Height: 40.2"-66.1", Weight: 10.4 lbs.  
**MS201B.....\$90.99**



Low Profile Tilt Base  
Legs adjust to fit around drum stands.  
Height: 12.4"-18.7", Weight: 2.2 lbs., Base radius: 6.7".  
**MS300B.....\$63.99**



Tilt Base  
Height: 40.6"-66.1", Weight: 8 lbs., Base Radius: 14.6".  
**MS401B.....\$114.99**



Low Profile Tripod Base  
Great for drum or amp mics.  
Height: 25.8", Boom Length: 30.7"-48", Weight: 4.7 lbs., Base Radius: 12.8".  
**MS540B.....\$90.99**



Hideaway Boom with 2-1 Clamp converts from a straight stand to a boom stand in seconds. Tripod base made of durable die cast aluminum. Height: 42.1"-94.5", Weight: 5.7 lbs., Base radius: 13.4", Boom length: 30.7".  
**MS533B.....\$100.99**



EZ Clutch mechanism.  
Height: 41.1"-66.1", Weight: 7 lbs. Base Radius: 13.4".  
**MS531B.....\$103.99**



**2-in-1 Boom Clamp**  
The new 2-in-1 Boom Clamp adjusts the boom length and angle at the same time! Simply loosen the knob and adjust to your desired position.  
**MB310B.....\$50.99**

www.herculesstands.com

# LIGHTING AND SPEAKER STANDS & ACCESSORIES

## QUIK LOK/ULTRA/TML



AMSSP180

Superior air-cushion design gently and safely lowers speaker cabinets eliminating sudden drops.

- AMSSP180** 48" to 72" .....\$159.99 pr.
- AMSS173BK** .....133.32 pr.
- KS156BK Ultra** .....166.35 pr.
- SS620 TML**.....74.55 ea.

## ON/STAGE



LS7805B

- LS7730** Lighting Stand with Truss .....\$367.99 set
- LS7720BLT** Lighting Stand with Side Bars 60-120" .....163.99 ea.
- LS7805B** Lighting Stand Power Crank-up 56-138" .....304.99 ea.
- EB9760** Exterior Mounting Bracket, 1 1/8" .....10.99 ea.
- SSA2** Adapter - 1 3/8" to 1 1/2" adapter .....8.99 ea.
- SSA1375** Adapter - .375 CL 1 3/8" to 1 3/8" cabinet insert .....10.99 ea.
- SSA15** Adapter - 1 1/2" CI - 1 1/2" cabinet insert .....10.99 ea.
- SSA45** Locking Speaker Adapter .....35.99 ea. Fits on 1 3/8" stands and mounts to any speaker cabinet with integrated pole mount.

## ON/STAGE



SSP7950

- SS7725B** All-Steel Speaker Stand 46-74" .....\$81.99 ea.
- SS7761B** All-Aluminum Speaker Stand 44-80" .....92.99 ea.
- SS7730B** Classic Speaker Stand 44-80" .....91.99 ea.
- SS8800B+** POWER Crank-up Speaker Stand 32-80" .....168.99 ea.
- SMS6000P** Studio Monitor Stand (Pair) 36-53" .....180.99 pr.
- SSP7850** Speaker Stand Pk 46-74" .....163.99 pk.
- SSP7950** All-Aluminum Speaker Stand Pak 44-80" .....219.99 pk.
- SSB6500** Heavy Duty Speaker Stand Bag .....55.99 ea.
- SS7914B** Wall Mount Speaker Bracket (Pair) Universal Fit ...96.99 pr.
- SS7740B** Subwoofer Attachment Shaft, 42"-1 3/8" .....19.99 ea.
- SS7745** Adjustable Subwoofer Attachment Shaft 31-55" .....24.99 ea.

# KÖNIG & MEYER MICROPHONE STANDS & ACCESSORIES



**KM20130B** Black.....\$75.00  
MICROPHONE STAND Cast alloy base for optimum stability. Heavy gauge steel tubing provides durability.

**KM26500B** Black.....\$64.99  
MICROPHONE STAND Glass-fiber reinforced resin base. Lightweight and portable.

**KM21021B** Black .....\$169.99  
OVERHEAD MICROPHONE STAND/BOOM PACKAGE

**KM21231B** Boom Arm .....\$199.99  
TALL OVERHEAD MICROPHONE BOOM

**KM24050B**.....\$64.99  
MICROPHONE MOUNTING ARM attaches to round or flat surfaces (up to 2 1/4") to hold microphone or accessories. Angle adjustable.



**KM19900B** Black.....\$89.99  
3-SECTION MICROPHONE STAND Extra compact folding, lightweight stand with wasy height adjustment.  
Weight: .....4 lb. Height: .....25-58 in.

**KM25200B** Black .....\$149.99  
3-SECTION MICROPHONE STAND/BOOM PACKAGE Cast alloy base with folding legs. Easy height adjustment. Complete with boom arm.  
Weight: .....7 lb. Height: .....27-86 in.  
Base Diameter: 18-30 in.

**KM20120B** Black .....\$104.99  
SHORT-LEGGED MICROPHONE STAND For limited space applications such as high traffic areas.  
Weight: .....4.5 lb. Height: .....36-63 in.  
Base Diameter: 22 in.

## K&M SPEAKER STANDS



**KM21436** .....\$129.99 ea.  
**KM21451** w/bags .....145.00 pr.



**KM21110B** Black.....\$45.00  
BOOM ARM Telescoping boom with counterweight.

**KM21100B** Black.....\$44.99  
BOOM ARM Fixed length with counterweight.

**KM21130B** Black.....\$39.99  
BOOM ARM Fixed length.

**KM25900B** Black .....\$109.99  
LOW LEVEL MICROPHONE STAND/BOOM PACKAGE Telescoping upright tube and telescoping boom for bass drums or special use.

**KM25910B** Black.....\$99.99  
LOW LEVEL MICROPHONE STAND/BOOM PACKAGE For bass drums or special use.



**KM23400B** Black .....\$109.99  
TILTABLE TABLE/FLOOR MICROPHONE STAND Cast-iron base. Telescoping tube with tilt/angle adjustment.

**KM23200B** Black.....\$54.99  
ROUND BASE TABLE MICROPHONE STAND Anti-vibration ring on cast-iron base.

**KM23510B**.....\$29.99  
MICROPHONE BAR Swivel, holds 2 mics

**KM23500B**.....\$29.99  
MICROPHONE BAR Connects to the top of microphone stands for holding 3 microphones or booms.

**KM23600B**.....\$44.99  
MICROPHONE BAR Similar to 23500, but will hold 5 microphones.



**KM22300B** Black.....\$49.99  
GOOSENECK Length: 16 in

**KM22400B** Black.....\$39.99  
GOOSENECK Length: 12 in



**KM25600B** Black .....\$189.99  
MICROPHONE STAND/BOOM PACKAGE Top of the line stand with telescoping boom.  
Height: 38-64 in.

**KM254B** Black .....\$44.99  
Tripod entry-level, microphone stand with the one-piece boom arm 26" long.

**KM21070B** Black.....\$76.99  
Tripod stand with fixed length boom, 31 1/2".

**KM21075B** Black .....\$86.99  
Tripod stand with telescoping boom arm, 16 3/4" to 28 1/2".

**KM27105B** Black.....\$79.99  
MICROPHONE STAND/BOOM PACKAGE Combines 26500 stand and 21130 boom.

**KM21020B** Black .....\$104.99  
MICROPHONE STAND/BOOM PACKAGE Combines 20130 stand and 21100 boom.

**KM21090B** Black .....\$109.99  
**KM21090C** Chrome.....125.00  
MICROPHONE STAND/BOOM PACKAGE Combines 20130 stand and 21110 boom.

**KM21060B**.....\$94.99  
TRIPOD STAND WITH FIXED LENGTH BOOM, 31".

**KM21080B**.....\$99.99  
TRIPOD STAND

**KM21120B**.....\$49.99  
TELESCOPING BOOM 22-38".

## MIC STAND HOLDERS

**KM16080** Headphones ....\$25.00  
**KM19710** 1 Pad .....60.00  
**KM19720** 1 Pad w/Clamp 93.00

www.k-m.de

PRICES MAY VARY DUE TO EURO/DOLLAR FLUCTUATION.  
CALL FOR CURRENT PRICING

# HAMILTON MICROPHONE & SPEAKER STANDS



## NU-ERA' LIGHTWEIGHT MIC STAND

Adjusts from 27½"- 62" high, folds to just 24", weighs only 20 oz.

**KB820.....\$23.99**



## STAGEPRO STRAIGHT TRIPOD MIC STAND

Height adjustment 39"- 66½", 3/8-16 to 5/8-27 thread adapter included. Composite hub and collet.

**KB210M.....\$39.99**



## STAGEPRO COMBO BOOM AND STRAIGHT TRIPOD MIC STAND

Boom length 25.7". Height adjustment 31.7"- 53.7". Base spread 23". Plastic clutch with plastic threaded sleeve. Plastic hub with steel threads.

**KB840M.....\$49.99**



## STAGEPRO EURO STYLE TRIPOD BASE BOOM STAND

Boom length 21.6"-37.6". Height adjustment 33"- 56". Base spread 23". Euro style extendable boom. Stamped steel hub. Plastic clutch with plastic threaded sleeve.

**KB845M.....\$53.99**



## STAGEPRO "E-TRIGGER" STRAIGHT DIE CAST BASE MIC STAND

Height adjustment 37½"- 63½".

**KB240M.....\$59.99**



## STAGEPRO TRIPOD BOOM MIC STAND

Boom length 30". Height adjustment 39"- 66½". Base spread 23". Aluminum die cast hub and collet for long use and abuse. T-handle for boom tilt adjustment.

**KB229M.....\$64.99**



## STAGEPRO "E-TRIGGER" STRAIGHT TRIPOD BASE MIC STAND

Height adjustment 37"- 67".

**KB241M.....\$79.99**



## STAGEPRO "E-TRIGGER" TRIPOD BASE FIXED BOOM MIC STAND

Boom length 25½". Height adjustment 37"- 67".

**KB242M.....\$89.99**

**KB858M Mic and Boom Bag.....\$17.99**



## STAGEPRO ACCESSORY BOOM

Boom length 22½" - 26½".

**KB850M.....\$20.99**



## 'NU-ERA' LIGHTWEIGHT TABLE TOP AND KICK DRUM MIC STAND

Height Adjustment 10" - 15".

**KB810.....\$14.99**



## 'NU-ERA' STAND WITH OFFSET ADAPTER

Height Adjustment 10" - 15" w/offset adapter.

**KB815M.....\$22.99**



## STAGEPRO ACCESSORY TELESCOPING MIC BOOM

Boom length adjusts 30"-46". Ergonomic T-Handle for tilt adjustment. Boom length 25¾". Metal boom clamp.

**KB202M.....\$23.99**



## STAGEPRO ALUMINUM SPEAKER STAND, DOUBLE END TUBE

Weight capacity 120 lbs. Upper shaft diameter 1½" to 1¾". Height adjustment 42"- 80". Max base spread 40". Aluminum tubing-steel center post for strength. Locking pin on chain for 5 preset heights.

**KB715S.....\$93.99**

**KB751S Two Speaker Stand Bag.....\$27.99**



## STAGEPRO STEEL SPEAKER STAND WITH ADAPTER

Weight capacity 120 lbs. Upper shaft diameter 1¾". Adapter for 1½" speaker mounts. Height adjustment 46"- 76". Max base spread 40". Steel tubing. Locking pin on chain for 5 preset heights.

**KB740S.....\$69.99**



## UNIVERSAL OFFSET ADAPTER

Adapter that allows heavier mics to be offset from stand. Reduces the risk of table top stands tipping over from off-center loads. Comes with sliding adapter and hardware for mounting. Can be used as a stereo mic adapter. Standard US mic thread.

**KB816M.....\$8.99**

## WINDSCREENS



### CABLE CORP.

Fits most ball type mics. Available in R (Red), BK (Black), GR (Gray), B (Blue), Y (Yellow), (O) Orange.  
**WS1** .....\$2.35  
**WS** .....2.10  
**WS2** Black SM57 Style .....2.35

### ON/STAGE WINDSCREEN

B (Black), BL (Blue), R (Red)  
**ASWS58** .....\$5.99

### SIGNAL FLEX WINDSCREEN

**SF63B** Ball Shaped Blue .....\$4.60

### WINDTECH

Specify: (GR) Gray, (W) White, (Y) Yellow, (R) Red, (B) Blue, (PU) Purple, (BK) Black, (TA) Tangerine, (BR) Brown, (PI) Pink, (G) Green, (NG), Neon Green, (NPI) Neon Pink, (NY) Neon Yellow.

**PA1** Spherical .....\$8.20  
**PA3MIX** 3 Assorted (RWB) .....24.45  
**PA3N** 3 Assorted, Neon .....24.45  
**PA3BK** 3 Black .....24.45

Tie Dye Ball Type Windscreens. (TDB) Blue, (TDR) Red, (TDG) Green

**PA1TD** .....\$10.85

Designed to fit SM57 style microphones. Available in Black, Gray, Blue and Red.

**PA57** .....\$7.95

Designed to fit a variety of microphones.

**PA9BK** Lge Spherical\* .....\$8.45  
**PA11BK** Lapel, Black .....6.35  
**PA12BK** Lge Cylindrical, Black .....7.45  
**PA20421** 2" XL Cylindrical .....44.50  
**PA13BK** Sml Cylindrical, Black .....7.20  
**PA15BK** Round Lavalier, Black .....6.55  
**PA21BK** Teardrop, Black .....6.35  
**PALAVBK** Lavalier, Black .....6.95  
**PAMINI** Lavalier, Mini, Black, Round .....5.90

\* = Gray, Red, Blue, Green, Yellow, White, Purple or Black

## ART



### 12V/48V PHANTOM POWER SUPPLY

The Phantom II provides phantom power for one or two condenser microphones. It has a 3-way 12V/OFF/48V selector switch which lets you choose 48V for microphones rated at 24 to 48V, 12V for lower-voltage microphones or "OFF" to conserve battery life. Low-noise operation is featured in all modes and can be used with an optional AC adapter.

**PHANTOMII** .....\$89.00B

## MICROPHONE HOLDERS



**MH1** Spring Type .....\$3.70  
**MH100B** Quick N EZ .....17.99  
**MC2** Wireless .....7.95  
**SFMH2** Drum Rim .....6.85  
**MH7SP** Clamp Type .....2.30  
**SP30** Shock Mount  
 Wireless .....13.99



**MH2** .....\$3.15  
**MH2M** Wireless .....4.10  
**MHR122** Hosa .....5.35  
**MH3W** Rubber .....5.15  
**SC106** Rubber .....2.40  
**SC110** Condenser .....2.40  
**MH2R** Rubber .....4.90  
**SP25** Shock Mount .....13.99  
**MMH346** Holds 4 Hosa .....38.55  
**MH101B** Qwik N EZ .....16.99  
**SP20** Shock Mount .....13.99  
**SC120** Suspension .....19.20



Allows a single microphone stand to have two microphones mounted.

**00381650** Peavy® .....\$11.79B  
**MA1** .....18.00  
**MMH472** .....22.05

## MIC-EZE



**MIC1** .....\$29.25  
**TRIPLETS** .....68.25B  
**MIE5** MIC1 w/5" Extension .....35.25B  
 Unique right-angle support arm swings forward & backward 180°.  
**MIC2** Female .....\$29.25  
 Mic holder arm extends to side.  
**MIC3** .....\$29.25  
**MIC4** Female quick release .....29.25  
**FLEX 3** Dual with 3" Flex Center .....47.25  
**FLEX 5** Dual with 5" Flex Center .....47.25B  
**MINEZE** .....47.25B  
 Dual Clamp with short trapeze center.  
**MAXEZE** .....47.25B  
 Dual Clamp with 1 3/4" straight center section.

## ON STAGE MIC CLIPS

**MY100** Dynamic Rubber .....\$18.99  
**MY110** Wireless Rubber .....\$18.99  
**MY200** Clothespin - Plastic .....11.99  
**MY250** Euro-style Plastic .....5.99  
**MY325** Shock-Mount .....23.99  
**MY330** Wireless Shock-Mount .....23.99  
**MY410** Studio Shock-Mount .....44.99  
 Clamp interior is lined with cloth to protect your mic.  
**DM50** Drum Rim Clip .....\$24.99  
 The reverse clamp design also allows for easier tightening and removal, while the isolation cylinders dampen unwanted vibrations.

## ART



### MICROPHONE SPLITTER/COMBINER

The ARTcessories SPLITComPro is an ideal audio utility to use in an application where you need to split a low impedance microphone signal to feed two separate mixers, or where it's necessary to combine balanced low impedance microphone signals from two mics into a single channel input.

**SPLITCOM** .....\$45.00B

## AUDIO TECHNICA MIC HOLDERS

**AT8405** Snap-in mic clamp; metal bottom (for 21 mm body dia.) .....\$19.95  
**AT8434** Lavalier - Plastic .....11.75  
**AT8139L** Large for (ATM75 & Pro8Hex) .....18.20  
**AT8139S** Small for (ATM75 & Pro8Hex) .....15.85  
**AT8418** Lavalier (Pro 7A, Pro 35X) .....68.05  
**AT8410a** Shock Mount .....95.00  
**AT8414** Metal Tie Bar .....35.20  
**AT8417** Wireless .....22.30  
**AT8420** Metal Mic Clip .....14.10

## VOICE SCREENS



### STOPPIT

Stops the pop in mics.

**POMT** Mic Stand adapter, goose neck and STOP6 .....\$43.50  
**STOP6** 6" diameter, Screen only .....19.95  
**STOP8** 8" diameter, Screen only .....22.95

### SIGNAL FLEX

**SFPF4** 4" Pop Filter .....\$33.50  
**SFPF6** 6" Pop Filter .....38.65  
**SFPFD6** 6" Deluxe, w/Gooseneck .....48.20  
**POPGARD** Windtech .....39.95B

### ON STAGE

**ASVS6GB** 6" w/Gooseneck & Clamp .....\$47.99  
**ASVS6B** 6" Adjustable Clip On .....37.99  
**ASVS4B** 4" Adjustable Clip-on .....31.99

## LINE TRANSFORMERS



### AUDIO TECHNICA

1/4" (M) - XLR (F), low to high.

**CP8201** .....\$18.00

### HOSA

**MIT435** 1/4" Male - XLR (F) .....\$22.55  
**MIT129** 1/4" Female - XLR Male .....22.55  
**MIT176** 1/4" Male - XLR (F) (pigtail) .....31.75

PRICES SUBJECT TO CHANGE WITHOUT NOTICE



# PEAVEY® MICROPHONE HOLDERS / WINDSCREENS



## BLACK MIC WINDSCREEN

Thick foam rubber windscreen reduces popping and other noises from being amplified. Fits standard size 1 3/8" ball-end microphones. Washable, hypoallergenic foam material. Packaged in a clear poly bag with header card. One per package.

**00069100** Black Mic Windscreen.....\$6.59B



## COLOR-CODED WINDSCREEN KIT 1 (Pkg. 4)

Colors include light gray, black, dark gray and navy blue. Fits standard 1 3/8" ball-end microphones. Washable, hypoallergenic foam material. Packaged individually in poly bags within master pack poly bag.

**00494280** Windscreen Kit 1 (pkg. 4).....\$18.99B



## COLOR-CODED WINDSCREEN KIT 2 (Pkg. 4)

Colors include purple, royal blue, red and yellow. Fits standard 1 3/8" ball-end microphones. Washable, hypoallergenic foam material. Packaged individually in poly bags within master pack poly bag.

**00494290** Windscreen Kit 2 (pkg. 4).....\$18.99B



## COLOR-CODED WINDSCREEN KIT 3 (Pkg. 4)

Colors include green, orange, brown and tan. Fits standard 1 3/8" ball-end microphones. Washable, hypoallergenic foam material. Packaged individually in poly bags within master pack poly bag.

**00494300** Windscreen Kit 3 (pkg. 4).....\$18.99B



## COLOR-CODED WINDSCREEN KIT (8)

Allows identification of stage mics. Colors include dark gray, navy blue, yellow, green, red, royal blue, light gray and black. Fits standard 1 3/8" ball-end microphones. Washable, hypo-allergenic foam material. Packaged individually in poly bags within master pack tube.

**00069160** Color-Coded Windscreen Kit..\$37.99B



## BLACK WINDSCREEN KIT (8)

Quality thick foam rubber windscreen prevents popping and other noise from being amplified. Fits standard size 1 3/8" ball-end microphones. Packaged eight windscreens per tube. Washable, hypoallergenic foam material.

**00381670** Black Windscreen Kit (8) .....\$35.99B



## MIC SPRING CLIP

Clothespin-type action. Fits many popular microphone models. Double spring-loaded. Vinyl inserts reduce microphone slippage. Made of hard, durable plastic. Standard 5/8" - 27 threads.

**00051860** Mic Spring Clip.....\$6.19B



## STANDARD TAPERED MIC CLIP

Front-loading, slide-type mic clip. Hard, plastic walls. Pivot mic clip with adjustment screw. Standard 5/8" - 27 threads.

**00054770** Standard Tapered Clip.....\$5.99B



## DIAMOND MIC CLIP

Rubber clip with brass-threaded inserts to ensure longer life. Fits most hand held mic models. Modern styling. Standard 5/8" - 27 threads.

**00376700** Diamond Mic Clip.....\$7.19B



## DELUXE MIC CLIP

Heavy duty mic clip with rubber insulator. Adjustable slip-in style mic clip has brass insert with 5/8" - 27 threads. Black finish.

**00381630** Deluxe Mic Clip .....\$11.59B



## SHOCK MOUNT MIC CLIP

Shock mount model SMC250 fits microphones 25mm and larger (hand held). Shock mount clip has brass insert with 5/8" - 27 threads. Shock mount mic clip dramatically reduces unwanted handling noise when mic is mounted to a mic stand.

**00495390** SMC250 Shock Mount Mic Clip.....\$13.59B



## SHOCK MOUNT MIC CLIP

SMC300 fits microphones 30mm and larger (wireless). Shock mount clip has brass insert with 5/8" - 27 threads. Shock mount mic clip dramatically reduces unwanted handling noise when mic is mounted to a mic stand.

**00495400** SMC300 Shock Mount Mic Clip.....\$13.59B



## TRIPLE MIC ADAPTER

Allows conversion of one mic stand to hold up to three microphones. Quality 5/8" - 27 brass insert stand mount with three male 5/8" - 27 mounting adapters. Black finish.

**00381640** Triple Mic Adapter.....\$14.59B



## FIVE SPACE MIC ADAPTER

Allows the flexibility to mount up to five mics on one mic stand. 5/8" - 27 brass mounting screws.

**00394810** Five Space Mic Adapter.....\$17.99B



## MIC STAND CLAMP

Mic stand clamp attaches to mic stand pole for micing acoustic guitars. Standard male 5/8" - 27 threads for gooseneck mount.

**00381650** Mic Stand Clamp.....\$11.79B



## WIRELESS MIC CLIP

Rugged plastic mic clip designed for use with hand-held wireless mics.

**00444910** Wireless Mic Clip.....\$13.99B



## PEAVEY MIC CLIP

Softer, more pliable mic clip. Equipped with metal mic clip adapter base with standard 5/8" - 27 threads. Molded Peavey logo.

**00050240** Peavey Mic Clip .....\$12.99B



## MICROPHONE ID TAPE

Assortment includes eight different tape colors. Identifies various stage microphones from the mixing board. Packaged in poly bag with header card. Roll length 20'.

**00072520** Microphone ID Tape.....\$18.99B

## PEAVEY® TUBES



00070710	EL 84 (2 per) EL 84	\$35.99B
00053120	Super 6's (2 per) 6L6GC	43.99B
00053150	Super 7's (1 per) 12 AX7	19.99B
00053240	Super C's (2 per) EL 34	51.99B
03004800	Tube Center Wall Display*	

\*Available with qualifying order – contact your sales rep for details.

## JJ TUBES



JJ12AX7AS		\$31.05
JJ12AX7AHG		31.95
JJ6L6GCCZD	Duet	79.20
JJ6L6GCCZQ	Quartet	158.40
JJE34LD	Duet	60.30
JJE34LQ	Quartet	120.40
JJEL84D	Duet	44.65
JJEL84Q	Quartet	89.30

## RUBY TUBES



<b>POWER TUBES</b>		
6550ARD	Duet	\$134.85
6550ARQ	Quartet	269.85
6L6GCSTRD	Duet	65.15
6L6GCSTRQ	Quartet	130.30
6L6GC5881D	Duet	62.05
6L6GC5881Q	Quartet	124.10
6V6GTSTRD	Duet	65.15
6V6GTSTRQ	Quartet	130.30
EL84RD	Duet	42.60
EL84RQ	Quartet	85.20
E34LCZD	Duet	61.25
E34LCZQ	Quartet	122.50
RT5881	5881 Retainer	1.70

### PRE AMP/RECTIFIER

12AX7AC5	\$25.35
5AR4CS	33.40
5U4GRS	23.70

www.magicparts.com

## GROOVE TUBES



### PREAMP MODELS

GT-12AX7R (ECC83, 7025)	\$24.99B
GT-12AX7R2	24.99B
GT-12AT7 (ECC81, 6201)	24.99B
GT-12AU7 (ECC82, 6189)	24.99B
GTECC83 (ECC83, 7025)	24.99B



### MATCHED OUTPUT SETS

GT-6V6CD	Duet	\$49.99B
GT6L6D	(KT66, 5881) Duet	69.99B
GT6L6Q	Quartet	139.99B
GT6L6CD	Duet, China	69.99B
GT6L6CQ	Quartet, China	139.99B
GT-6550D	Duet	139.99B
GT-EL34D	Duet	79.99B
GTEL34RD	Duet, Russian	69.99B
GT-EL34Q	Quartet	159.99B
GTEL34RQ	Quartet, Russian	139.99B
GTEL84D	Duet	59.99B
GTEL84Q	Quartet	119.99B
GT5881CD	Duet, China	69.99B
GT5881CQ	Quartet, China	139.99B



### RECTIFIER MODEL

GT5AR4	\$34.99B
GT5U4	34.99B
GT5Y3	34.99B



### CLASSIC MULLARD REISSUE

GTEL34MD	Duet	\$69.99B
GTEL34MQ	Quartet	139.99B

www.groovetubes.com

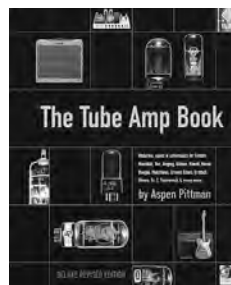

MSBC66	The Tube Amp Book – Deluxe Revised Ed, by Aspen Pittman	\$49.99
--------	---	---------

## SOVTEK TUBES



NS12AX7WA		\$20.55
NS12AX7WB	7025	26.25
NSEL84		16.55
NSEL84D	Matched Pair	45.65
NSEL84Q	Matched Quartet	91.35
NS5881	6L6	28.80
NS5881WXT		29.95
NS6550	6550	51.05
NS5881D	Matched Pair	63.60
NS5881Q	Matched Quartet	127.20
NS6550D	Matched Pair	108.05
NS6550Q	Matched Quartet	216.15
NSKT88	KT88	51.15
ECC832		27.10
12BH7		26.25

## ELECTRO HARMONIX



12AX7EH	\$21.40
12AT7EH	21.95
12AY7EH	27.10
6V6EH	25.25
6L6EH	31.10
EL34EH	29.10
EL84EHD	45.65
EL84EHQ	91.35
6550EH	54.00

6V6EHD	56.45
6V6EHQ	112.95
6L6EHD	68.15
6L6EHQ	136.35
EL34EHD	64.15
EL34EHQ	128.30

www.ehx.com



MSBC67	Tube Guitar Amplifier Essentials, by Gerald Weber	\$34.95
--------	---	---------

**FAX & E-MAIL ORDERS FOR PRINTED MUSIC WILL GET AN EXTRA 5% DISCOUNT**

FAX: (708) 496-2130 • (888) 983-5537

E-MAIL: sales@harristeller.com

# HEARING PROTECTION ACCESSORIES



## MACK'S ACOUSTIC FOAM EAR PLUGS

The ultimate in earplug comfort, Mack's silicone putty molds to the unique contours of any ear. Carrying case included.

**MACK5** .....\$3.49B/2 pr.



Mack's® Hear Plugs® unique open-air membrane filter ensures natural sound and comfort while reducing harmful noise. With a convenient travel case and Noise Reduction Rating (NRR) of 12dB.

**MACK16** .....\$17.99B pr.



## 1 PAIR CORDED EARPLUGS

Convenient neck cord for hanging earplugs around neck in situations where noise starts and stops Storage case included.

**MACK961** .....\$3.49B pr.



## EXTREME COMFORT

Simple insertion, even in narrower auditory canals. Concerts, jam sessions, nightclubs, shop work, etc.

**MACK963** .....\$2.19B/3 pr.



Blocks out 20dB, allowing the user to preserve their hearing while still enjoying music.

**MACK967** .....\$5.49B/7 pr.



## ULTRA SOFT FOAM EAR PLUGS

These ear plugs are molded with super low-pressure, skinned and tapered foam, with a high noise reduction rating (NPR) of 32 dB. Aluminum carrying case included. (7 pair)

**MACK927** .....\$5.99B/7 pr.



## 100 PAIR TUB

Individually-wrapped, single pairs; great for concerts, nightclubs, festivals or any loud events.

**MACK196** .....\$100.00B



## HEAROS EAR FILTERS

Comfortable hearing protection. Great add-ons for parents of beginning music students. One size fits all. Easy insertion and removal.

<b>H2525</b>	20 Pair of H4414 (Bulk) .....	<b>\$10.50</b>
<b>H211</b>	High Fidelity Hearos, 1 pair .....	<b>14.99B</b>
<b>H2826</b>	Extreme Hearos, 7 pair.....	<b>5.49</b>
<b>H2414</b>	Hearos, reduce noise 30dB .....	<b>2.99</b>
<b>H2210</b>	Super Hearos, keychain case .....	<b>5.49</b>
<b>H309</b>	Rock Hearos, keychain case .....	<b>5.49</b>
<b>HEAR311</b>	Hi-fi, long term wear.....	<b>14.99B</b>
<b>H2104</b>	12, H2414, 6 ea. 201, 309, 1001 .....	<b>121.50</b>

## HEAROS TOWER DISPLAY

100 pairs, in disposable bags.

**HEAR411** Clear plastic tub of 100 pairs.....**\$102.00**



## VIC FIRTH EAR PLUGS

<b>VFEPL</b>	Large .....	<b>\$29.99 pr.</b>
<b>VFEPR</b>	Regular.....	<b>29.99 pr.</b>



## FENDER EAR PLUGS

<b>0541</b>	Concert Series Foam Ear Plugs (4 pair) .....	<b>\$4.49</b>
<b>0541049</b>	Concert Plugs Bowl (100 pair) .....	<b>116.99</b>
<b>0542</b>	Musician Series Black Ear Plugs.....	<b>8.99</b>
<b>0543</b>	Touring Series Hi Fi Ear Plugs.....	<b>17.99</b>



## PLANET WAVES/D'ADDARIO NOISE GUARDS DISPOSABLE EAR PLUGS

<b>PWEP1</b>	Planet Waves .....	<b>\$2.30</b>
<b>PWEP100</b>	100 PWEP1 .....	<b>183.60</b>

## VATER

**VATVSAS** Safe & Sound.....**\$31.49**

## NOISE GUARDS



## NOISE FILTERS

Reduces discomfort and noise hangover. Protects your hearing. Lets you hear ALL THE MUSIC. Comfortable, easy to carry and use.

<b>400710</b>	Sonic II .....	<b>\$10.60B</b>
<b>400584</b>	Foam, 18 pair .....	<b>5.98B</b>
<b>400716</b>	Comfit .....	<b>3.98B</b>

# AUDIO ACCESSORIES



2 Conductor Silent Plug, solder lug terminals and mylar tube insulation. 2 piece shielded handle with cable clamp.  
**BFQP** Switchcraft .....\$8.75B



2 conductor screw on connector  
**SW2501F** Switchcraft .....\$8.40B



Small Size Phone Plug fits standard 1/4" jack. Screw Terminal. 2 conductor.  
**SW270** Switchcraft .....\$12.10B  
**BF2P** PROCO .....4.05



1/4"-2 Conductor Phone Plug. Solder terminal.  
**SW280** Switchcraft .....\$2.75B  
**SI281** Senior .....2.75



Same as 280 only 3 conductor type and .206" diameter sleeve.  
**SW297** Switchcraft .....\$5.65B  
**SI297** Senior .....3.20



Jumbo Size Phone Plug. 2 conductor, solder lugs  
**SW184L** Switchcraft .....\$6.50B



Miniature 2 Conductor Plug. 1/8" size of standard-plugs. Solder type terminal.  
**SW780** Switchcraft .....\$7.75B



Phono Plug. 2 conductor.  
**SW3502** Switchcraft .....\$2.65B  
**SI299** Senior .....2.65



2 Conductor Extension Phone Jack with solder lugs. Nickel plated.  
**SW121** Switchcraft .....\$10.40B  
**NYS22022P** Senior .....4.35

Same as above—3 conductor.  
**SW131** Switchcraft .....\$14.25B



Silent Plug, solder lugs, mylar tube insulation. Long handle.  
**SW182** Switchcraft .....\$26.20B

2 Conductor, solder terminal, shielded handle.  
**SW228** Switchcraft Right Angle .....\$11.25B  
**SW226** Barrel Shape Right Angle .....5.00B  
**SI287** Senior Right Angle .....4.70



Phone Ext. Jax. Removable handle. Cable clamp shielded.  
**SW3503** Switchcraft .....\$6.15B



Standard 1/4" Phone Jack with long bushing to mount in panels up to 1 1/4" thick.  
**SW151** Switchcraft .....\$10.60B  
**SW152B** Stereo .....12.90B



Adapter, 2 Conductor Phone Jack Input to female microphone output.  
**SW332A** Switchcraft .....\$19.35B



Standard Size 1/4" Female Jack.  
**SW11** Switchcraft .....\$2.50B  
**11PC** PROCO .....2.50  
**SI503** Senior .....1.90



**SW363** Switchcraft .....\$14.50B  
**SI550** Senior .....5.85  
**GPP296** Hosa .....3.65



Adapter, 2-Conductor Phone Jack Input to Phono Plug Output. Main body only 1/2" O.D. Attractively nickel plated. Completely shielded.  
**SW336A** Switchcraft .....\$26.85B



Standard Size 1/4" Female Jack. 3-conductor.  
**SW12B** Switchcraft .....\$3.00B  
**SI504** Senior .....2.15



Coupler, 2 Conductor 1/4" Jack in each end.  
**SW361A** .....\$15.10B  
**361APC** PROCO .....3.95  
**SI551** Senior .....5.85



1/4" Female – XLR Female.  
**SW383A** Switchcraft .....\$25.30B  
**SI316** Senior .....8.90



1/4" Female – XLR Male.  
**SW384A** Switchcraft .....\$23.10B  
**SI314** Senior .....8.90



XLR - Female – 1/4" Male.  
**SW386A** Switchcraft .....\$23.95B  
**SI315** Senior .....8.90



XLR Male – 1/4" Male.  
**SW387A** Switchcraft .....\$21.70B  
**SI313** Senior .....8.90

ON-OFF Switch. Plugs directly into microphone. Female XLR.  
**GMS274** XLR (F) - XLR (M) HOSA .....\$21.55



XLR Female Plug.  
**SWA3F** Switchcraft .....\$5.65B  
**SI301** Senior .....5.80  
**SWTA4F** Tiny Plug w/ Switch .....21.05B



XLR Male Plug.  
**SWA3M** Switchcraft .....\$5.35B  
**SI300** Senior .....4.65



Female panel receptacle. 3 contacts. Mounts with 2 screws.  
**SWD3F** Switchcraft .....\$5.35B



Male panel receptacle. 3 contacts. Mounts with 2 screws.  
**SWD3M** Switchcraft .....\$5.65B

## AUDIO ACCESSORIES

Male XLR Coupler  
**SW390** Switchcraft .....\$19.90B  
**GXX144** Hosa .....8.15

Female XLR Coupler  
**SW389** Switchcraft .....\$23.90B  
**SI311** Senior .....10.05  
**GXX145** Hosa .....9.80

Right Angle Cord Plug  
**SWR3M** Male XLR – Switchcraft .....\$13.05B  
**SWR3F** Female XLR – Switchcraft .....13.60B  
**XRR318F** Female XLR – Hosa .....5.00

## PROCO CONNECTORS & ADAPTORS

**PART** **EACH**  
 CC11 .....\$5.65/ 2 pk.  
 CC361APC .....4.05  
 CC363PC .....2.75

**PART** **EACH**  
 CC330PJPC .....\$3.10  
 CC340PC .....3.20  
 CC341PC .....4.15  
 CC342PC .....2.30  
 CC343PC .....2.30  
 CC344PC .....2.90  
 CC374PC .....2.60



CC11



CC374PC



CC330PJPC



CC330PJPC



CC342PC



CC363PC

## HOSA Y CABLES



Stereo 1/4" Phone (M), Two RCA (F).  
**YPR102** .....\$4.15  
**YPR103** Mono .....3.50



1M-2F XLR .....\$12.15  
**YXM121** 1F-2M XLR.....11.50



RCA (M) to Two RCA (F).  
**YRA104** .....\$3.30  
**YRA115** 1/4"(F) - 2 RCA(F) .....4.25



RCA (F) to Two RCA (M).  
**YRA105** .....\$3.30  
**YMR197** 35mm(F) - 2RCA(M).....4.35



Mono 1/4"(M) to Two RCA (M).  
**YPR124** .....\$3.50



1/4" M 2 1/4" F  
**YPP111** .....\$5.45  
**SF206** 2 Pack .....8.15  
**YPP117** Stereo Mono (F) .....6.45



1/4" F – 2 1/4" M  
**YPP106** .....\$4.85  
**YPP136** Stereo .....5.10



Stereo 1/4" (M) to two 1/4" F Stereo  
**YPP118** .....\$5.95  
**YMP137** 35mm(M) – 2 1/4" (F) .....5.60



Mono 1/4" (F) To 2 RCA (M)  
**YPR131** .....\$4.75



Mono 1/4" (M) to two 1/4" (M), 5 feet.  
**CYP105** .....\$8.25

Stereo 3.5 mm (M) – 2.3.5 mm (F) Mono  
**YMM261** .....\$5.10

Stereo 3.5 mm (M) – 2 3.5 mm (F)  
**YMM232** .....\$5.35

Stereo 3.5 mm (M) – 2 RCA(F)  
**YRA154** .....\$4.15  
**YRA167** RA YRA 154.....4.15

3.5mm to Dual 3.5mm TSF  
**YMM379** .....5.45

3.5 mm TRS (F) – 2 RA 3.5 mm TS (M)  
**YMM492** .....\$4.15

Stereo 1/4" (F) to RCA(M)  
**YPR257** .....\$5.10

Stereo 35 mm (M) – 2 1/4" (F)  
**YMP233** .....\$5.60

Stereo 1/4" (M) 2-35mm (F)  
**YMP234** .....\$5.60

Stereo 1/4" (M) – Stereo 1/4" (F)  
**DOC106** .....\$12.10

## AUDIO ACCESSORIES

**PLG025W** 1/4" plug, large hole.....\$3.40  
**PLG035** 3.5mm TRS plug.....2.30  
**JMB025** 1/4" plug, jumbo shell .....4.50  
**NL4FC** Speak on Connect or Cable End .....16.40  
**NL4MP** Speak on Sml F, Cabinet Jack .....6.90  
**NL4MPR** Speak on Rnd F, Round Cabinet Jack.....7.50  
**NL4MMX** Speak on Coupler, Extension Coupler .....13.95  
**NA4LJX** Speak on to 1/4" Female .....18.95  
**NL2FC** Speakon 2 pole.....9.15

## HOSA ADAPTORS



GXX144



GPP146



GXJ235



GXX145



GPR101



GPP296



GPR104



GPM103



CFS106



IRG1005



GPP105



GRA101



GMD108



GMP112



GMP113



GRM114

**GPP290** STEREO 1/4" (F) - MONO 1/4" (M) .....\$2.65  
**GPP359** STEREO 1/4" (M) - 2 1/4" (F).....3.40  
**GXJ183** XLR (F) - 1/4 TRS (F) .....8.75  
**GXP246** XLR (M) - 1/4 TRS (M).....8.75  
**GXM133** XLR (M) - RCA (F).....7.15  
**GPR101** RCA (F) - 1/4" PHONE (M) 2 PACK.....3.15  
**GRA259** RT. ANG. RCA (F) - RCA (M) .....3.90/2  
**GPM103** STEREO 3.5 MM (F) - STEREO 1/4" PHONE (M) .....2.30  
**GPM179** STEREO 3.5mm (F) - MONO 1/4" (M) .....2.90  
**GPR104** 1/4" PHONE (F) - RCA (M) .....2.65  
**CFS106** 6" JUMPER CABLE, MOLDED 1/4" PLUGS .....3.15  
**IRG1005** 6" JUMPER CABLE, METAL 1/4" PLUGS .....4.60  
**GRA101** COUPLER, RCA (F) - RCA (F) .....2.90  
**GPP105** COUPLER, 1/4" PHONE (F) - 1/4" PHONE (F) .....3.65  
**GMD108** COUPLER, MIDI (F) - MIDI (F).....4.75  
**GMM303** COUPLER, 3.5MM TRS (F) - 3.5 TRS (F) .....2.55  
**GMP112** STEREO 1/4" PHONE (F) - STEREO 3.5 MM(M) .....2.45  
**GMP113** MONO 1/4" PHONE (F) - MONO 3.5 MM (M) .....2.45  
**GRM114** RCA (F) - MONO 3.5 MM (M) .....2.90  
**GPP146** Mono 1/4" (M) to Mono 1/4" (M) Offset .....4.85  
**GPP296** Mono 1/4" (M) to Mono 1/4" (M) Straight .....3.65  
**GXX145** XLR (F) - XLR(F) COUPLER .....9.80  
**GXX144** XLR (M) - XLR(M) COUPLER .....8.15  
**BNA100** BANANA PLUG, RED OR BLACK .....2.45  
**BNA240** BANANA PLUG, RED OR BLACK .....2.90  
**GPP151** RIGHT ANGLE ADAPTER 1/4(F)F - 1/4"(M).....4.00  
**GXJ235** XLR (M) - 1/4" TRS (F) .....7.65  
**BNP116** BANANA - 1/4" (F), 6", 16 AWG .....14.55  
**BNA260** PRO BANANA, 12 AWG .....5.80  
**PMDP** PROCO BANANA PLUG .....2.60  
**GXR134** RCA(M) - XLR(F).....8.15  
**GPP273** STEREO 1/4" R.A.(F) - STEREO 1/4" (M) .....5.60  
**GXX195** XLR (F) - XLR (M) COUPLER.....8.35  
**GLT255** XLR (F) - XLR (M) GROUND LEFT .....8.35  
**GXF-132** RCA(F) to XLR(F) .....8.25  
**GXR135** RCA(M) to XLR(M) .....7.30  
**GSK116** 1/4" F - SPEAK ON, 16 GAUGE, 6" .....17.35  
**GMS274** INLINE MIC ON/OFF SWITCH .....16.35  
**GXP143** XLR (F) - 1/4" (M) TRS .....8.15  
**GMP386** 1/4" (F) TRS - 3.5mm (M) TRS .....2.45  
**GMP467** 3.5mm (F) TRS - 2.5mm (M) (RA) TRS .....2.65  
**GMP500** 2.5mm (F) TRS - 3.5mm (M) TRS .....2.65

## NEUTRIK

**NA3FJ** 1/4"(F)-XLR(F) .....\$30.95  
**NA3FP** 1/4"(M)-XLR(F) .....34.55  
**NA3MJ** 1/4"(F)-XLR(M) .....29.60  
**NA3MP** 1/4"(M)-XLR(M) .....34.25  
**NC3FX** XLR(F) .....7.35  
**NC3MP** XLR(M) .....\$7.05  
**NC3MX** XLR(M) .....6.75  
**NA3MMW** XLR(M)-XLR(M).....27.30  
**NP2C** 1/4" Male .....7.85

# HOSA CABLES



## MIDI CABLES

<b>MID301</b>	1 foot MIDI Cable .....	<b>\$5.70</b>
<b>MID303</b>	3 foot MIDI Cable .....	<b>6.20</b>
<b>MID305</b>	5 foot MIDI Cable, blue, red .....	<b>6.80</b>
<b>MID310</b>	10 foot MIDI Cable, black, red, white, blue .....	<b>8.15</b>
<b>MID315</b>	15 foot MIDI Cable .....	<b>9.95</b>
<b>MID320</b>	20 foot MIDI Cable .....	<b>11.40</b>
<b>MID325</b>	25 foot MIDI Cable .....	<b>12.75</b>

## MIDI CABLE WITH METAL ENDS.

<b>MID503</b>	3 Foot .....	<b>\$8.25</b>
<b>MID505</b>	5 Foot .....	<b>8.75</b>
<b>MID510</b>	10 Foot .....	<b>9.95</b>
<b>MID515</b>	15 Foot .....	<b>12.00</b>
<b>MID520</b>	20 Foot .....	<b>14.20</b>
<b>MID525</b>	25 Foot .....	<b>16.60</b>

## DUAL MIDI

<b>MID201</b>	3.3 Foot .....	<b>\$8.50</b>
<b>MID202</b>	6.6 Foot .....	<b>10.20</b>
<b>MID203</b>	9.9 Foot .....	<b>11.90</b>
<b>MID204</b>	13.2 Foot .....	<b>13.60</b>

## DIGITAL/AUDIO CABLES

<b>DRA501</b>	3.3 Foot, Gold RCA .....	<b>\$8.85</b>
<b>DRA502</b>	6.6 Foot, Gold RCA .....	<b>10.90</b>
<b>DRA504</b>	13.2 Foot, Gold RCA .....	<b>15.15</b>



## AUDIO CABLES

<b>MCL103</b>	3 ft. XLR3F to XLR3M .....	<b>9.25</b>
<b>MCL105</b>	5 ft. XLR3F to XLR3M .....	<b>10.65</b>
<b>PXF105</b>	5 Foot XLR(F) - 1/4" (M) .....	<b>\$8.25</b>
<b>PXF110</b>	10 Foot XLR (F) - 1/4" (M) .....	<b>9.20</b>
<b>PXF115</b>	15 Foot XLR (F) - 1/4" (M) .....	<b>10.80</b>
<b>PXM103</b>	3 Foot XLR (M) - 1/4" (M) .....	<b>7.30</b>
<b>PXM105</b>	5 Foot XLR (M) - 1/4" (M) .....	<b>7.75</b>
<b>PXM110</b>	10 Foot XLR (M) - 1/4" (M) .....	<b>8.95</b>
<b>PXM115</b>	15 Foot XLR (M) - 1/4" (M) .....	<b>9.70</b>
<b>XLR103</b>	3 Foot XLR (M) - XLR (F) .....	<b>8.50</b>
<b>XLR105</b>	5 Foot XLR (M) - XLR (F) .....	<b>9.10</b>
<b>XRF105</b>	5 Foot XLR (F) - RCA (M) .....	<b>8.00</b>
<b>XRM105</b>	5 Foot XLR (M) - RCA (M) .....	<b>7.50</b>
<b>XRM110</b>	10 Foot XLR (M) - RCA (M) .....	<b>8.75</b>
<b>XRM115</b>	15 Foot XLR (M) - RCA (M) .....	<b>10.20</b>
<b>XRR105</b>	5 Foot XLR (M) Right Angle - XLR (F) .....	<b>9.45</b>
<b>XRR110</b>	10 Foot XLR (M) Right Angle - XLR (F) .....	<b>11.65</b>
<b>XRR115</b>	15 Foot XLR (M) Right Angle - XLR (F) .....	<b>13.70</b>
<b>XFF103</b>	3 Foot XLR (M) - XLR (RAF) .....	<b>8.50</b>
<b>XFF105</b>	5 Foot XLR (M) - XLR (RAF) .....	<b>9.45</b>
<b>XFF110</b>	10 Foot XLR (M) - XLR (RAF) .....	<b>11.65</b>
<b>XFF115</b>	15 Foot XLR (M) - XLR (RAF) .....	<b>13.30</b>
<b>XVM105F</b>	15 Foot XLR (F) - 3.5mm TRS (RA) .....	<b>10.05</b>
<b>XVM115F</b>	5 Foot XLR (F) - 3.5mm TRS (RA) .....	<b>10.65</b>
<b>XVM105M</b>	5 Foot XLR (M) - 3.5mm TRS to (RA) .....	<b>9.81</b>
<b>XVM110M</b>	10 Foot XLR (M) - 3.5mm TRS to (RA) .....	<b>10.05</b>
<b>XVM115M</b>	15 Foot XLR (M) - 3.5mm TRS to (RA) .....	<b>10.42</b>



## DUAL CABLE

<b>CRA201PB</b>	3.3 Foot RCA-RCA with (F) junction x 2 .....	<b>\$7.05</b>
<b>CRA203PB</b>	9.9 Foot RCA-RCA with (F) junction x 2 .....	<b>10.65</b>

## MISCELLANEOUS CABLES

<b>MHE1005</b>	3.5 mm Stereo (RA) (M) - 1/4" stereo (F) 6" .....	<b>\$4.60</b>
<b>CMP310</b>	3.5 mm Mono - 1/4" (M) 10 Foot Mono .....	<b>6.30</b>
<b>CMP153</b>	3.5 mm Stereo (M) - 2 1/4" (M) 3 Foot .....	<b>6.55</b>
<b>CMS103</b>	3' 3.5mm Stereo (M) - 1/4" TRS (M) .....	<b>5.35</b>
<b>CMS105</b>	5' 3.5mm Stereo (M) - 1/4" TRS (M) .....	<b>5.80</b>
<b>CMS110</b>	10' 3.5 mm Stereo (M) - 1/4" TRS (M) .....	<b>6.90</b>
<b>CMR203</b>	3.5 mm Stereo (M) - 2 RCA (M) .....	<b>5.80</b>
<b>PDC373</b>	4 Effect Power Cable .....	<b>13.70</b>
<b>USM422</b>	USB to MIDI .....	<b>44.45</b>
<b>HPE310</b>	10' Stereo Headphone Ext., 1/4" (F) - 1/4" (M) .....	<b>7.75</b>
<b>MHE310</b>	10' Stereo Headphone Ext., 3.5mm (F) - 1/4" (M) .....	<b>7.40</b>
<b>MHE325</b>	25' Stereo Headphone Ext. 3.5mm (F) - 1/4" (M) .....	<b>11.65</b>
<b>HPE325</b>	25 Foot Stereo Headphone Extension, Straight .....	<b>10.90</b>
<b>HPE325C</b>	25 Foot Stereo Headphone Extension, Coiled .....	<b>15.65</b>
<b>MHE110</b>	10' Stereo Ext. 3.5mm (M) - 3.5mm (F) .....	<b>7.05</b>
<b>MHE125</b>	25 Foot Stereo Extension, 3.5mm (M) - 3.5mm (F) .....	<b>10.55</b>
<b>USB205AB</b>	5 Foot USB-A-USB-B Cable .....	<b>6.55</b>
<b>USB210AB</b>	10 Foot USB-A-USB-B Cable .....	<b>7.50</b>
<b>USB215AB</b>	15 Foot USB-A-USB-B Cable .....	<b>9.45</b>



<b>CRA103</b>	3 ft. RCA (M) to RCA (M) .....	<b>4.50</b>	(GOLD TIPS)	
<b>CRA105</b>	5 ft. RCA (M) to RCA (M) .....	<b>5.20</b>	<b>CRA201AU</b> .....	<b>\$6.80</b>
<b>CRA110</b>	10 ft. RCA (M) to RCA (M) .....	<b>6.90</b>	<b>CRA202AU</b> .....	<b>8.50</b>
<b>CRA115</b>	15 ft. RCA (M) to RCA (M) .....	<b>8.85</b>	<b>CRA203AU</b> .....	<b>10.20</b>
<b>CRA201</b>	Dual RCA (M) to RCA (M) (3.3 ft.) .....	<b>\$6.20</b>		
<b>CRA202</b>	Dual RCA (M) to RCA (M) (6.6 ft.) .....	<b>7.50</b>		
<b>CRA203</b>	Dual RCA (M) to RCA (M) (9.8 ft.) .....	<b>8.95</b>		
<b>CRA204</b>	Dual RCA (M) to RCA (M) (13.2 ft.) .....	<b>10.45</b>		
<b>CRA206</b>	Dual RCA (M) to RCA (M) (20 ft.) .....	<b>13.35</b>		
<b>CRA201PB</b>	3.3 ft. Dual RCA to Dual Piggyback RCA .....	<b>7.05</b>		
<b>CRA202PB</b>	6.6 ft. Dual RCA to Dual Piggyback RCA .....	<b>8.75</b>		
<b>CRA203PB</b>	9.9 ft. Dual RCA to Dual Piggyback RCA .....	<b>10.65</b>		
<b>CPR103</b>	RCA (M) - 1/4" 3 ft. .....	<b>\$4.60</b>		
<b>CPR105</b>	RCA (M) - 1/4" 5 ft. .....	<b>5.35</b>		
<b>CPR110</b>	RCA (M) - 1/4" 10 ft. .....	<b>6.80</b>		
<b>CPR115</b>	RCA (M) - 1/4" 15 ft. .....	<b>8.50</b>		
<b>CPR201</b>	Dual Cable (RCA to 1/4" Phone), 1 m (3.3 ft.) .....	<b>6.80</b>		
<b>CPR202</b>	Dual Cable (RCA to 1/4" Phone), 2 m (6.6 ft.) .....	<b>8.35</b>		
<b>CPR203</b>	Dual Cable (RCA to 1/4" Phone), 3 m (9.8 ft.) .....	<b>9.95</b>		
<b>CPR204</b>	Dual Cable (RCA to 1/4" Phone), 4 m (13.2 ft.) .....	<b>11.90</b>		
<b>CPP105</b>	1/4" to 1/4" 5 ft. .....	<b>\$5.45</b>		
<b>CPP110</b>	1/4" to 1/4" 10 ft. .....	<b>6.90</b>		
<b>CPP115</b>	1/4" to 1/4" 15 ft. .....	<b>8.60</b>		
<b>CPP201</b>	Dual Cable (1/4" to 1/4" Phone) 1 m (3.3 ft.) .....	<b>7.15</b>		
<b>CPP202</b>	Dual Cable (1/4" to 1/4" Phone) 2m (6.6 ft.) .....	<b>8.60</b>		
<b>CPP203</b>	Dual Cable (1/4" to 1/4" Phone) 3 m (9.8 ft.) .....	<b>9.95</b>		
<b>CPP204</b>	Dual Cable (1/4" to 1/4" Phone) 4 m (13.2 ft.) .....	<b>11.75</b>		



## SNAKE CABLE

<b>CRA802</b>	Color Coded, 2 m (6.6 ft) x 8 (RCA to RCA) .....	<b>\$28.95</b>
<b>CRA803</b>	Color Coded, 3 m (9.8 ft) x 8 (RCA to RCA) .....	<b>36.95</b>
<b>CPR802</b>	Color Coded, 2 m (6.6 ft) x 8 (RCA to 1/4" Phone) .....	<b>30.30</b>
<b>CPR803</b>	Color Coded, 3 m (9.8 ft) x 8 (RCA to 1/4" Phone) .....	<b>38.75</b>
<b>CPR804</b>	Color Coded, 4 m (13.2 ft) x 8 (RCA to 1/4" Phone) .....	<b>47.25</b>
<b>CPR805</b>	Color Coded, 5 m (16.5 ft) x 8 (RCA to 1/4" Phone) .....	<b>55.75</b>
<b>CPR807</b>	Color Coded, 7 m (23 ft) x 8 (RCA to 1/4" Phone) .....	<b>72.45</b>
<b>CPP801</b>	Color Coded, 1 m (3.3 ft.) x 8 (1/4" to 1/4" Phone) .....	<b>24.25</b>
<b>CPP802</b>	Color Coded, 2 m (6.6 ft) x 8 (1/4" to 1/4" Phone) .....	<b>32.70</b>
<b>CPP803</b>	Color Coded, 3 m (9.8 ft) x 8 (1/4" to 1/4" Phone) .....	<b>41.05</b>
<b>CPP804</b>	Color Coded, 4 m (13.2 ft) x 8 (1/4" to 1/4" Phone) .....	<b>44.10</b>
<b>CSS845</b>	1/4" TRS - 1/4" TRS 1.5 ft. x 8 .....	<b>26.80</b>
<b>CSS802</b>	1/4" TRS - 1/4" TRS 6.6 ft. x 8 .....	<b>46.05</b>
<b>CSS803</b>	1/4" TRS - 1/4" TRS 9.9 ft. x 8 .....	<b>50.90</b>
<b>CSS804</b>	1/4" TRS - 1/4" TRS 13.2 ft. x 8 .....	<b>60.55</b>
<b>CSS805</b>	1/4" TRS - 1/4" TRS 16.5 ft. x 8 .....	<b>67.50</b>
<b>CSS807</b>	1/4" TRS - 1/4" TRS 23.1 ft. x 8 .....	<b>85.50</b>
<b>STX804M</b>	1/4" TRS - XLR(M) 13.2 ft. x 8 .....	<b>65.40</b>
<b>SH8X4100</b>	12 CH, 100' Snake, 8 x 4 .....	<b>547.35</b>
<b>SH12X4100</b>	12 CH, 100' Snake, 12 x 4 .....	<b>675.15</b>
<b>SH16X4100</b>	12 CH, 100' Snake, 16 x 4 .....	<b>833.60</b>



## BALANCED CABLES

<b>STX103M</b>	3 Foot XLR (M) - 1/4" Stereo .....	<b>\$8.25</b>
<b>STX105M</b>	5 Foot XLR (M) - 1/4" Stereo .....	<b>8.75</b>
<b>STX110M</b>	10 Foot XLR (M) - 1/4" Stereo .....	<b>9.70</b>
<b>STX115M</b>	15 Foot XLR (M) - 1/4" Stereo .....	<b>10.65</b>
<b>STX102F</b>	2 Foot XLR (F) - 1/4" Stereo .....	<b>8.50</b>
<b>STX103F</b>	3 Foot XLR (F) - 1/4" Stereo .....	<b>8.75</b>
<b>STX105F</b>	5 Foot XLR (F) - 1/4" Stereo .....	<b>9.70</b>
<b>STX110F</b>	10 Foot XLR (F) - 1/4" Stereo .....	<b>10.20</b>
<b>STX115F</b>	15 Foot XLR (F) - 1/4" Stereo .....	<b>12.00</b>
<b>CMM103</b>	3.5 mm TRS - 3.5 mm TRS 3' .....	<b>4.75</b>
<b>CMM105</b>	3.5 mm TRS - 3.5 mm TRS 5' .....	<b>5.35</b>
<b>CMM110</b>	3.5 mm TRS - 3.5 mm TRS 10' .....	<b>6.55</b>
<b>CMM115</b>	3.5 mm TRS - 3.5 mm TRS 15' .....	<b>8.00</b>
<b>CMM303</b>	3.5 mm TS - 3.5 mm TS 3' .....	<b>4.35</b>
<b>CMM305</b>	3.5 mm TS - 3.5 mm TS 5' .....	<b>4.85</b>
<b>CMM310</b>	3.5 mm TS - 3.5 mm TS 10' .....	<b>5.95</b>
<b>CMM510</b>	2.5mm TRS - 2.5mm TRS 10' .....	<b>7.30</b>
<b>CMP105</b>	3.5 mm Stereo Male to 1/4" Male Mono (5 ft) .....	<b>5.20</b>
<b>CMP110</b>	3.5 mm Stereo Male to 1/4" Male Mono (10 ft) .....	<b>6.30</b>
<b>CMP159</b>	3.5 mm Stereo Male - 2 1/4" Male (10 ft) .....	<b>9.35</b>
<b>CMP153</b>	3.5 mm Stereo (M) - 2 1/4" (M) 3 Foot .....	<b>6.55</b>
<b>CYX403M</b>	3.5mm Stereo Male to 2 XLR Male Stereo 3 Foot .....	<b>\$17.20</b>
<b>CMR203</b>	3.5 mm Stereo Male to 2 - RCA Male (3 ft) .....	<b>5.80</b>
<b>CMR206</b>	3.5 mm Stereo Male to 2 - RCA Male (6 ft) .....	<b>7.30</b>
<b>CMR210</b>	3.5 mm Stereo Male to 2 - RCA Male (10 ft) .....	<b>9.20</b>
<b>CRA120</b>	RCA - RCA (20 foot) .....	<b>10.55</b>

# CABLES



## HOSA

<b>OPT102</b>	2 Foot Fiber optic, Toslink Type .....	<b>\$8.50</b>
<b>OPT103</b>	3 Foot Fiber optic, Toslink Type .....	<b>9.70</b>
<b>OPT106</b>	6 Foot Fiber optic, Toslink Type .....	<b>12.10</b>
<b>OPT110</b>	10 Foot Fiber optic, Toslink Type .....	<b>17.55</b>
<b>OPT117</b>	16.5 Foot Fiber optic, Toslink Type .....	<b>21.80</b>
<b>OPM303</b>	3 Foot Premium Fiber optic, Toslink Type .....	<b>\$17.45</b>
<b>OPM305</b>	5 Foot Premium Fiber optic, Toslink Type .....	<b>18.80</b>
<b>OPM310</b>	10 Foot Premium Fiber optic, Toslink Type .....	<b>26.15</b>
<b>OPM320</b>	20 Foot Premium Fiber optic, Toslink Type .....	<b>37.05</b>



## Speaker Cables

<b>SKZ620</b>	20 Foot, 16 Gauge, 1/4" - 1/4" .....	<b>\$27.40</b>
<b>SKO405</b>	5 Foot, 14 Gauge, Neutrik Speak On to same .....	<b>43.85</b>
<b>SKO415</b>	15 Foot, 14 Gauge, Neutrik Speak On to same .....	<b>68.20</b>
<b>SKO420</b>	20 Foot, 14 Gauge, Neutrik Speak On to same .....	<b>80.90</b>
<b>SKJ630BN</b>	30', 16 Gauge 1/4" Banana .....	<b>35.50</b>
<b>SKM230BN</b>	30', 12 Gauge 1/4" Banana, Clear .....	<b>61.80</b>
<b>SKM630BN</b>	30', 16 Gauge 1/4" Banana, Clear .....	<b>32.60</b>
<b>SKT203</b>	3 ft. 12 Gauge Neutrik Speak On to same (2 OFC) .....	<b>36.70</b>
<b>SKT205</b>	5 ft. 12 Gauge Neutrik Speak On to same (2 OFC) .....	<b>39.75</b>
<b>SKT210</b>	10 ft. 12 Gauge Neutrik Speak On to same (2 OFC) .....	<b>50.05</b>
<b>SKT215</b>	15 ft. 12 Gauge Neutrik Speak On to same (2 OFC) .....	<b>56.95</b>
<b>SKT225</b>	25 ft. 12 Gauge Neutrik Speak On to same (2 OFC) .....	<b>75.35</b>
<b>SKT250</b>	50 ft. 12 Gauge Neutrik Speak On to same (2 OFC) .....	<b>115.95</b>
<b>SKT210Q</b>	10 foot Speak-on to 1/4" .....	<b>39.75</b>
<b>SKT225Q</b>	25 foot Speak-on to 1/4" .....	<b>65.05</b>
<b>SKT230Q</b>	30 foot Speak-on to 1/4" .....	<b>73.30</b>
<b>SKT250Q</b>	50 foot Speak-on to 1/4" .....	<b>107.20</b>
<b>SKT450</b>	50 foot 14 gauge, neutrik to same (2 OFC) .....	<b>79.95</b>

## Balanced Cables

<b>TRS201</b>	Return/Send (3.3 ft) (1/4" Stereo to 2 RCA) .....	<b>\$6.30</b>
<b>TRS202</b>	Return/Send (6.6 ft) (1/4" Stereo to 2 RCA) .....	<b>7.90</b>
<b>TRS203</b>	Return/Send (9.8 ft) (1/4" Stereo to 2 RCA) .....	<b>9.60</b>
<b>TRS204</b>	Return/Send (13.2 ft) (1/4" Stereo to 2 RCA) .....	<b>11.15</b>
<b>STP201</b>	Return/Send (3.3 ft) (1/4" Stereo to 2 1/4" Phone) .....	<b>6.80</b>
<b>STP202</b>	Return/Send (6.6 ft) (1/4" Stereo to 2 1/4" Phone) .....	<b>8.35</b>
<b>STP203</b>	Return/Send (9.8 ft) (1/4" Stereo to 2 1/4" Phone) .....	<b>10.05</b>
<b>STP204</b>	Return/Send (13.2 ft) (1/4" Stereo to 2 1/4" Phone) .....	<b>11.65</b>
<b>STP802</b>	Return/Send (6.6 ft) (1/4" Stereo to 2 1/4" Phone) x 4 .....	<b>31.00</b>
<b>STP803</b>	Return/Send (9.8 ft) (1/4" Stereo to 2 1/4" Phone) x 4 .....	<b>39.40</b>
<b>STP804</b>	Return/Send (13.2 ft) (1/4" Stereo to 2 1/4" Phone) x 4 .....	<b>48.20</b>



## Patch Bay

<b>CPP830</b>	Color Coded Cables, 30 cm (1 ft)x8 (1/4" Phone to 1/4" Phone) .....	<b>\$19.25</b>
<b>CPP845</b>	Color Coded Patch Bay Cables, 45 cm (1.5 ft) x 8 (1/4" Phone to 1/4" Phone) .....	<b>20.00</b>
<b>CPP890</b>	(1/4" Phone to 1/4" Phone) 3 ft x 8 .....	<b>23.40</b>

## HOSA

<b>PDR369</b>	12 Channel, XLR .....	<b>\$145.35</b>
<b>Firewire (6 pin - 6 pin)</b>		
<b>FIW66106</b>	6 Foot .....	<b>\$13.60</b>
<b>FIW66110</b>	10 Foot .....	<b>16.95</b>



## Digital Converter

<b>ODL276</b>	Fiber to Coax Link .....	<b>\$162.55</b>
<b>CDL313</b>	Coaxial Data Link .....	<b>175.15</b>

www.hosatech.com

## REAN

### HOSA PRO GUITAR CABLES

#### REAN STRAIGHT TO SAME

<b>HGTR010</b>	10 ft. ....	<b>\$15.40</b>
<b>HGTR015</b>	15 ft. ....	<b>20.50</b>
<b>HGTR020</b>	20 ft. ....	<b>23.75</b>

#### REAN STRAIGHT TO RIGHT ANGLE

<b>HGTR010R</b>	10 ft. ....	<b>\$16.60</b>
<b>HGTR015R</b>	15 ft. ....	<b>19.85</b>
<b>HGTR020R</b>	20 ft. ....	<b>24.00</b>

Nickel-plated REAN plugs for efficient signal transfer and superior durability. 20 AWG Oxygen-free copper (OFC) conductor for a louder, clearer signal. 90% OFC braided shield for a higher signal to noise ratio.

### HOSA CABLE LABELS/GAFF TAPE

Cable Labels, a Tablet of 60 Peel, Stick Vinyl

<b>LBL466</b>	.....	<b>\$10.65</b>
---------------	-------	----------------

#### GAFF TAPE

<b>GFT447B</b>	2" wide, 180 ft. ....	<b>26.65</b>
----------------	-----------------------	--------------

### HOSA CABLE TESTER

#### CBT500

Capable of testing: XLR (3-pin and 5-pin), balanced and unbalanced phone (1/4" in TRS and TS), Phono (RCA), SpeakON® (with support for 2-pole, 4-pole, and 8-pole connectors), DIN (multi-pin, including 5-pin DIN commonly used for MIDI equipment), Ethernet (RJ-45), USB Type A to Type B.

<b>CBT500</b>	.....	<b>\$77.75</b>
---------------	-------	----------------

### PEAVEY CABLE TESTER



#### CT-10 CABLE TESTER

Tests cables with 1/4" TRS, balance XLR male/female, phono/RCA, banana plug, SpeakON®, and 5-pin DIN. LEDs confirm continuity. Six-way switch for selecting connections to be tested. Rugged, compact, metal construction.

<b>00563070</b>	.....	<b>\$49.99B</b>
-----------------	-------	-----------------



## Dubbing

<b>VRA302</b>	6.6 ft. Stereo VCR Dubbing .....	<b>\$11.05</b>
<b>VRA303</b>	9.9 ft. Stereo VCR Dubbing .....	<b>13.45</b>
<b>VRA304</b>	13.2 ft. Stereo VCR Dubbing .....	<b>16.00</b>
<b>CCD103</b>	3' CD Control .....	<b>6.20</b>

<b>CSS103</b>	3 Foot stereo 1/4 (M) - 1/4 (M) .....	<b>\$5.60</b>
<b>CSS105</b>	5 Foot stereo 1/4 (M) - 1/4 (M) .....	<b>6.20</b>
<b>CSS110</b>	10 Foot stereo 1/4 (M) - 1/4 (M) .....	<b>7.90</b>
<b>CSS115</b>	15 Foot stereo 1/4 (M) - 1/4 (M) .....	<b>9.60</b>
<b>CYR101</b>	3.3 Foot 1/4 (M) - 2 RCA (M) .....	<b>6.05</b>
<b>CYR102</b>	6.6 Foot 1/4 (M) - 2 RCA (M) .....	<b>7.50</b>
<b>CYR103</b>	9.8 Foot 1/4 (M) - 2 RCA (M) .....	<b>9.20</b>

<b>CRA203R</b>	9.9 Ft. Dual Cable, RCA (M) - R.A.RCA (M) .....	<b>\$9.70</b>
<b>CFR210</b>	10 Ft. 3.5mm Stereo (F) - 2 RCA (M) .....	<b>9.45</b>
<b>CRA201RR</b>	3.3 Ft. Dual R/A RCA (M) - RCA (M) .....	<b>6.55</b>

### EXTENSION CORDS

3 conductor extension cords.

<b>E1636</b>	16 g., 6' .....	<b>\$15.90</b>
<b>E16312</b>	16 g., 12' .....	<b>24.75</b>
<b>E16325</b>	16 g., 25' .....	<b>44.05</b>
<b>E12350PB</b>	12 g., 50' w/ power block .....	<b>\$197.10</b>
<b>PWX403</b>	14 g., 3' .....	<b>\$11.65</b>

# CONQUEST SOUND

## HUSH INSTRUMENT

Lifetime Warranty  
USA-1 Wire/Conquest 1/4" Plugs

HUSH31	1'	\$11.70
HUSH33	3'	12.65
HUSH36	6'	14.05
HUSH310	10'	16.10
HUSH318	18'	19.70
HUSH325	25'	26.15
HEX10	10' Extension	21.85



## WRAPPER INSTRUMENT

Lifetime Warranty  
USA-1 Wire/Conquest 1/4" Plugs  
Heat Shrink Process

WRAP3	3'	\$14.65
WRAP6	6'	16.70
WRAP10	10'	19.45
WRAP18	18'	24.75
WRAP25	25'	29.55



## SG INSTRUMENT

Lifetime Warranty  
Custom Inst. Wire/Quality 1/4" Plugs

TLIQQ6	6'	\$8.40
TLIQQ10	10'	12.30
TLIQQ18	18'	13.80



## SG INSTRUMENT

Lifetime Warranty  
Custom Inst. Wire/Quality 1/4" Plugs  
Heat Shrink Process.

TLHS6	6'	\$11.40
TLHS10	10'	15.30
TLHS18	18'	16.80



## HUSH STRAIGHT/ANGLE

Lifetime Warranty  
USA-1 Wire/Conquest 1/4" Straight Plugs & 1/4" Right Angle Plug

HQA06	6"	\$15.80
HQA1	1'	13.50
HQA018	18"	13.70
HQA3	3'	14.45
HQA6	6'	15.80
HQA10	10'	18.25
HQA18	18'	23.65



## HUSH ANGLE/ANGLE

Lifetime Warranty  
USA-1 Wire/Conquest 1/4" Right Angle Plugs

HUSHRR	6'	\$15.05
HUSH1RR	1'	15.30
HUSH15RR	1.5'	15.50
HUSH6RR	6'	17.75
HUSH10RR	10'	20.40
HUSH18RR	18'	25.80



## QUIET LINE W/SILENT PLUG

Lifetime Warranty  
USA-1 Wire/Anti-Pop and Conquest 1/4" Plugs

QL10	10'	\$26.30
QL18	18'	29.25
QL25	25'	32.70



## CSI SPEAKER CABLES

Lifetime Warranty  
Heavy Duty Cable and 1/4" Plugs  
No extra charge for double banana plug

CSI318	\$13.35	CSI5016	\$45.75
CSI618	15.60	CSI10016	98.40
CSI2018	22.80	CSI314	18.90
CSI3018	27.50	CSI614	21.25
CSI5018	40.55	CSI1014	25.40
CSI316	16.40	CSI2014	36.95
CSI616	17.70	CSI3014	47.40
CSI1016	19.85	CSI5014	66.75
CSI2016	28.35	CSI10014	128.40
CSI3016	33.85		



## CUSTOM SHOP HI DEFINITION GUITAR CABLES

Conquest custom shop instrument cables feature Optima 4 conductor, 95% coverage braid shielded wire designed for maximum low frequency EMI noise rejection. The 4 conductors form a "double hum bucking" system that reduces noise induction providing crystal clear highs, tight bottom end and full spectrum audio clarity. Highest quality materials and craftsmanship. Made in USA.

CQC10	10' Custom Shop Cloth Covered Optima w/Neutrik 1/4" Plugs, Black/Gold	\$64.95
CQC18	18' Custom Shop Cloth Covered Optima w/Neutrik 1/4" Plugs, Black/Gold	89.00
CQC25	25' Custom Shop Cloth Covered Optima w/Neutrik 1/4" Plugs, Black/Gold	99.75
CQCQLN18	18' Custom Shop Optima w/Neutrik 1/4" Straight to 1/4" Angle, Black/Gold, AU Silent	103.50
OPIQA10	10' Custom Shop Optima Inst Cable Switchcraft 1/4" Straight to 1/4" Angle	36.15
OPIQA18	18' Custom Shop Optima Inst Cable Switchcraft 1/4" Straight to 1/4" Angle	45.90
OPI10	10' Custom Shop Optima Inst Cable w/Switchcraft 1/4" Plugs	33.00
OPI18	18' Custom Shop Optima Inst Cable w/Switchcraft 1/4" Plugs	42.75
OPI25	25' Custom Shop Optima Inst Cable w/Switchcraft 1/4" Plugs	51.25

## SNI NP2X-B / NP2X-B

SNI10	10' Custom Shop Optima Inst Cable w/Neutrik 1/4" Plugs, Black/Gold	\$45.75
SNI18	18' Custom Shop Optima Inst Cable w/Neutrik 1/4" Plugs, Black/Gold	57.25
SNI25	25' Custom Shop Optima Inst Cable w/Neutrik 1/4" Plugs, Black/Gold	67.00
SNIQA10	10' Custom Shop Optima Inst Cable w/Neutrik 1/4" Straight to 1/4" Angle	52.25
SNIQA18	18' Custom Shop Optima Inst Cable w/Neutrik 1/4" Straight to 1/4" Angle	65.75
SNIQLN18	18' Custom Shop Optima Inst Cable w/Neutrik 1/4" Straight to 1/4" Angle, AU Silent	77.00

## 18GA ZIP SPEAKER CABLES

Lifetime Warranty  
18ga Zip Cable and Conquest 1/4" Plugs

S2ZIP3	3'	\$11.15
S2ZIP6	6'	12.85
S2ZIP10	10'	15.25
S2ZIP20	20'	20.75
S2ZIP30	30'	26.60



## HI D 12GA SPEAKER CABLES

Lifetime Warranty  
12ga Hi D Cable and Heavy Duty 1/4" Plugs

HID3	3'	\$33.60
HID6	6'	43.20
HID10	10'	50.30
HID20	20'	69.60
HID25	25'	84.00
HID30	30'	103.20
HID50	50'	133.70
HID100	100'	230.40



## N216 SPEAKON CABLES

Lifetime Warranty  
Conquest 16 Ga Wire Neutrik 2 Pole Speakon Connectors

N21610	2 Conductor 10'	\$37.45
N21620	2 Conductor 20'	46.35
N21630	2 Conductor 30'	55.20
N216150	2 Conductor 50'	95.05



## BANANA ADAPTERS

Lifetime Warranty  
CS118 or 16 Gauge Wire - 1/4" Female to Double Banana Plug

BF18	18"	\$17.76
BF16	18"	21.00





# CONQUEST SOUND

## S2B MICROPHONE CABLES

Lifetime Warranty

S2B Wire/Switchcraft XLR Plugs

<b>S2B3</b>	3'	\$22.50
<b>S2B6</b>	6'	24.35
<b>S2B10</b>	10'	26.50
<b>S2B20</b>	20'	32.90
<b>S2B30</b>	30'	39.85
<b>S2B50</b>	50'	53.65



## TLMC MICROPHONE CABLES

Economy XLR Microphone Cables

<b>TLMC3</b>	3'	\$10.65
<b>TLMC6</b>	6'	11.70
<b>TLMC10</b>	10'	14.05
<b>TLMC25</b>	25'	16.95
<b>TLMC50</b>	50'	30.20



## RA2 MICROPHONE CABLES

Lifetime Warranty

Tour Quality, USA2 Wire/Switchcraft XLR Plugs

<b>RA23</b>	3'	\$29.15
<b>RA26</b>	6'	31.15
<b>RA210</b>	10'	33.40
<b>RA220</b>	20'	42.85
<b>RA230</b>	30'	50.15
<b>RA250</b>	50'	68.40
<b>RA2100</b>	100'	122.75

Neutrik NC3FXS with ON/OFF switch optional



## HIGH IMPEDANCE CABLE

Lifetime Warranty

XLR Female to 1/4" Male Plug.

RA4 = SW2501F Screw on to 1/4" Male Plug

<b>RA310</b>	10'	\$21.85
<b>RA3</b>	20'	28.20
<b>RA4</b>	20'	34.35



## "Y" CABLES (18 INCH)

Lifetime Warranty

Mono 1/4" "Y" Cables and LoZ "Y" Cables

<b>M1Y</b>	1 Male/2 Female	\$29.70
<b>M2Y</b>	1 Female/2 Male	29.70
<b>LOZ</b>	1 Male/2 Female	30.35
<b>ZOL</b>	1 Female/2 Male	30.35



## GMS STEREO 1/8" Y CABLES

GMS2RM 3.5mm to Dual RCA

Lifetime Warranty

Conquest 2ch Wire Neutrik 1/8" - 2 Neutrik RCA Male

<b>GMS2RM15</b>	1.5' 1/8" TRS - 2 RCA-M 1.5'	\$24.75
<b>GMS2RM3</b>	3' 1/8" TRS - 2 RCA-M 3'	38.40
<b>GMS2RM6</b>	6' 1/8" TRS - 2 RCA-M 6'	43.45
<b>GMS2RM10</b>	10' 1/8" TRS - 2 RCA-M 10'	49.95

## GMS2XM 3.5mm to Dual XLR Male

Lifetime Warranty

Conquest 2ch Wire Neutrik 1/8" - 2 Switchcraft XLR Male

<b>GMS2XM15</b>	1.5' 1/8" TRS - 2 RCA-M 1.5'	\$24.75
<b>GMS2XM3</b>	3' 1/8" TRS - 2 RCA-M 3'	38.40
<b>GMS2XM6</b>	6' 1/8" TRS - 2 RCA-M 6'	43.45
<b>GMS2XM10</b>	10' 1/8" TRS - 2 RCA-M 10'	49.95

## BALANCED LINE CABLES

Lifetime Warranty

S2B Wire/Switchcraft XLRs

Amphenol 1/4" Black/Gold TRS

<b>BLC10FM</b>	(XLRF/TRSM) 10'	\$27.85
<b>BLC15FM</b>	(XLRF/TRSM) 15'	31.30
<b>BLC20FM</b>	(XLRF/TRSM) 20'	34.70
<b>BLC10MM</b>	(XLRF/TRSM) 10'	27.85
<b>BLC15MM</b>	(XLRF/TRSM) 15'	31.30
<b>BLC20MM</b>	(XLRF/TRSM) 20'	34.70
<b>SGC210</b>	(TRSM/TRSM) 10'	26.25
<b>SGC220</b>	(TRSM/TRSM) 20'	32.90



## IPQM 3.5MM I-POD, MP3, COMPUTER CABLES

Lifetime Warranty

Conquest CS1022 Wire Neutrik 1/8" - Neutrik 1/4" Mono

<b>IPQM3</b>	3' 1/8" TRS M - 1/4" T/S M 3'	\$17.75
<b>IPQM6</b>	6' 1/8" TRS M - 1/4" T/S M 6'	23.05
<b>IPQM10</b>	10' 1/8" TRS M - 1/4" T/S M 10'	29.75

## IPXM 3.5MM I-POD, MP3, COMPUTER CABLES

Lifetime Warranty

Conquest CS1022 Wire Neutrik 1/8" - Switchcraft XLR M

<b>IPXM3</b>	3' 1/8" TRS M - XLR M 3'	\$22.35
<b>IPXM6</b>	6' 1/8" TRS M - XLR M 6'	27.60
<b>IPXM10</b>	10' 1/8" TRS M - XLR M 10'	34.55

## IPSQM 3.5MM I-POD, MP3, COMPUTER CABLES

Lifetime Warranty

Conquest CS1022 Wire Neutrik 1/8" - 1/4" Stereo Male

<b>IPSQM3</b>	3' 1/8" TRS M - 1/4" T/S M 3'	\$18.25
<b>IPSQM6</b>	6' 1/8" TRS M - 1/4" T/S M 6'	23.55
<b>IPSQM10</b>	10' 1/8" TRS M - 1/4" T/S M 10'	30.25

## MC MIDI CABLES

Lifetime Warranty

Conquest Quad Wire/5 Pin Din Plugs - 5 Pin Active

<b>MC3</b>	3'	\$29.75
<b>MC6</b>	6'	32.30
<b>MC10</b>	10'	35.75
<b>MC15</b>	15'	40.00
<b>MC20</b>	20'	44.25



## RCA CABLES

Lifetime Warranty

USA-1 Wire/Conquest RCA Plugs

<b>HRR1</b>	1'	\$12.25
<b>HRR3</b>	3'	14.30
<b>HRR6</b>	6'	17.05
<b>HRR10</b>	10'	17.05



## RCA TO 1/4" CABLES

Lifetime Warranty

USA-1 Wire/Conquest 1/4" and RCA Plugs

<b>HRQ1</b>	1'	\$12.15
<b>HRQ3</b>	3'	13.65
<b>HRQ6</b>	6'	14.60
<b>HRQ10</b>	10'	17.75



## BULK AUDIO WIRE

<b>BBC</b>	20 Ga Shielded Instrument Wire	\$.72 pf
<b>LOZMIC</b>	20 Ga 2 Cond Shielded Mic Wire	1.10 pf
<b>SPKW18</b>	18 Ga 2 Cond Speaker Wire	.72 pf
<b>SPKW16</b>	16 Ga 2 Cond Speaker Wire	.96 pf
<b>SPKW14</b>	14 Ga 2 Cond Speaker Wire	1.45 pf

## STAINLESS STEEL WALL PLATES

<b>CP1DF</b>	1 Gang w/1 D3F XLR F	\$15.00
<b>CP2DF</b>	1 Gang w/2 D3F XLR F	24.00
<b>CP4DF</b>	2 Gang w/4 D3F XLR F	45.60
<b>CP111</b>	1 Gang w/1 1/4" TS	9.60
<b>CP211</b>	1 Gang w/2 1/4" TS	13.20
<b>CP411</b>	2 Gang w/4 1/4" TS	26.40



CP2DF

# FENDER CALIFORNIA SERIES CABLES

## California Series Instrument Cable

Fender California Series Cables are designed specifically for high performance. The braided shield is optimally stranded with OFC copper for superior sound quality and frequency balance. Backed by a lifetime guarantee, Fender cables are an excellent choice for all of your cable needs.



<b>510002</b>	10' California Instrument Cable, Lake Placid Blue .....	<b>\$19.99</b>
<b>510057</b>	10' California Instrument Cable, Surf Green.....	<b>19.99</b>
<b>510009</b>	10' California Instrument Cable, Candy Apple Red.....	<b>19.99</b>
<b>515002</b>	15' California Instrument Cable, Lake Placid Blue.....	<b>24.99</b>
<b>515057</b>	15' California Instrument Cable, Surf Green.....	<b>24.99</b>
<b>515009</b>	15' California Instrument Cable, Candy Apple Red.....	<b>24.99</b>
<b>520002</b>	20' California Instrument Cable, Lake Placid Blue .....	<b>29.99</b>
<b>520057</b>	20' California Instrument Cable, Surf Green.....	<b>29.99</b>
<b>520009</b>	20' California Instrument Cable, Candy Apple Red.....	<b>29.99</b>
<b>500049</b>	6" California Series Bowl of 20 Assorted .....	<b>179.80</b>



## Squier Cables

### Instrument Cables

Squier Instrument Cables offer the professional musician a quality product. All cables are hand soldered with rugged metal connectors to ensure quality and reliability.

<b>1915090</b>	Squier® Instrument Cable, 15 ft. 3 pack .....	<b>\$39.99</b>
<b>1915</b>	Squier® Instrument Cable, 15 ft. ....	<b>14.99</b>
<b>1900049</b>	Squier® Patch Cable, 6" (20 pcs fishbowl) .....	<b>139.99</b>



### Microphone Cables

Squier Microphone Cables offer the musician or studio professional a quality product. All cables are hand soldered with rugged metal connectors to ensure quality and reliability.

### High Quality, Durable Metal Connectors

<b>1920049</b>	Squier® Microphone Cable, 20 ft. 3 pack .....	<b>\$44.99</b>
<b>1920100</b>	Squier® Microphone Cable, 20 ft. ....	<b>29.99</b>

## California Series Speaker Cable

Fender California Series Speaker Cables are designed specifically for high performance. Dual conductors are individually insulated and twisted together to provide the cleanest audio signal from your source to your speakers. Backed by a lifetime guarantee, Fender cables are an excellent choice for all of your cable needs. **Available in both 14 and 16 AWG.**



<b>0516010</b>	5' 16GA Speaker Cable 1/4 - 1/4.....	<b>\$24.99</b>
<b>0516020</b>	5' 16GA Speaker Cable 1/4 - Speakon.....	<b>39.99</b>
<b>0516030</b>	5' 16GA Speaker Cable Speakon.....	<b>59.99</b>
<b>2516010</b>	25' 16GA Speaker Cable 1/4 - 1/4 .....	<b>49.99</b>
<b>2516020</b>	25' 16GA Speaker Cable 1/4 - Speakon.....	<b>69.99</b>
<b>2516030</b>	25' 16GA Speaker Cable Speakon.....	<b>89.99</b>
<b>5016010</b>	50' 16GA Speaker Cable 1/4 - 1/4 .....	<b>69.99</b>
<b>5016020</b>	50' 16GA Speaker Cable 1/4 - Speakon.....	<b>89.99</b>
<b>5016030</b>	50' 16GA Speaker Cable Speakon.....	<b>109.99</b>



<b>0514010</b>	5' 14GA Speaker Cable 1/4 - 1/4.....	<b>39.99</b>
<b>0514020</b>	5' 14GA Speaker Cable 1/4 - Speakon.....	<b>59.99</b>
<b>0514030</b>	5' 14GA Speaker Cable Speakon.....	<b>79.99</b>
<b>2514010</b>	25' 14GA Speaker Cable 1/4 - 1/4 .....	<b>59.99</b>
<b>2514020</b>	25' 14GA Speaker Cable 1/4 - Speakon.....	<b>79.99</b>
<b>2514030</b>	25' 14GA Speaker Cable Speakon.....	<b>99.99</b>
<b>5014010</b>	50' 14GA Speaker Cable 1/4 - 1/4 .....	<b>89.99</b>
<b>5014020</b>	50' 14GA Speaker Cable 1/4 - Speakon.....	<b>109.99</b>
<b>5014030</b>	50' 14GA Speaker Cable Speakon.....	<b>129.99</b>

# RAPCO HORIZON CABLES



## G1 GUITAR CABLES

Model	Length	Price
RHG16	6'	9.80
RHG110	10'	11.25
RHG115	15'	13.75
RHG120	20'	15.90



## M1 LO-Z MICROPHONE CABLES

Model	Length	Price
RHM110	10'	\$18.20
RHM120	20'	21.95
RHM125	25'	23.60
RHM130	30'	25.65
RHM150	50'	34.70



## VOLUME CONTROL INSTRUMENT CABLE 18 FEET

Model	Length	Price
RHVC25018	18'	\$99.50



## NM1-50 LO-Z MICROPHONE CABLE WITH NEUTRIK XLRs

Model	Length	Price
RHNM13	3'	\$22.85
RHNM16	6'	24.00
RHNM10	10'	26.35
RHNM20	20'	29.55
RHNM25	25'	30.50
RHNM50	50'	42.05

## STAGE SERIES M1 MICROPHONE CABLE W/RHC CONNECTORS

Model	Length	Price
RHRM120	20'	\$25.00
RHRM125	25'	26.00



## SPEAKER CABLES

Model	Length	Price
RHH1625	(16 GA) 25'	\$30.20
RHH1650	(16 GA) 50'	50.10
RHH1450	(14 GA) 50'	73.20
RHH12100	(12 GA) 100'	194.30



## STAGE SERIES M1 MICROPHONE CABLE W/NEUTRIK CONNECTORS

Model	Length	Price
RHN1M125	25'	\$30.35

# PEAVEY® ACCESSORIES



## MOLDED PATCH CABLES

00054550	1' Color Coded Patch Cables (6) .....	\$17.69
00054570	3' Color Coded Patch Cables (6) .....	22.49
00069580	4" RA/RA Molded Patch Cables (6).....	17.99



## CABLE TESTER

### CT-10 CABLE TESTER

Tests cables with 1/4" TRS, balance XLR male/female, phono/RCA, banana plug, SpeakOn®, and 5-pin DIN. LEDs confirm continuity. Six-way switch for selecting connections to be tested. Rugged, compact, metal construction.

00563070 .....\$49.99B



## CABLES

00576010	PV® 5' Instrument Cable .....	\$9.89
00576020	PV 10' Instrument Cable .....	11.99
00576030	PV 15' Instrument Cable .....	14.94
00576040	PV 20' Instrument Cable .....	17.39
00578860	PV 10' Multi-Color Instrument.....	17.99
00578870	PV 15' Multi-Color Instrument.....	21.89
00578880	PV 20' Multi-Color Instrument.....	25.49
00576220	PV 10' Low Z Mic Cable .....	16.79
00576230	PV 20' Low Z Mic Cable .....	20.69
00576270	PV 10' High Z Mic Cable .....	13.19
00576280	PV 20' High Z Mic Cable .....	17.99
00576210	PV 5' Low Z Mic Cable .....	14.99
00576240	PV 25' Low Z Mic Cable .....	22.49
00576070	PV 25' 18 Gauge S/S Speaker Cable .....	14.99
00576080	PV 25' 16 Gauge S/S Speaker Cable .....	20.39
00576090	PV 50' 16 Gauge S/S Speaker Cable .....	32.39
00576100	PV 25' 14 Gauge S/S Speaker Cable .....	26.39
00576110	PV 50' 14 Gauge S/S Speaker Cable .....	44.99
00576120	PV 25' 12 Gauge S/S Speaker Cable .....	40.49

**Limited lifetime warranty.**



## BATTERIES

00497010	AA BATTERIES 4 PK .....	\$3.59 B
00050130	BATTERY,9V,SINGLE PACK .....	\$3.59 B
00578740	BATTERY DISPLAY*	

\*Available with qualifying order-contact your sales rep for details.



## CONNECTORS

00496030	2-Pole Neutrik® Female Cable Mount Speakon® Connector NL2FC .....	\$6.79B
00495520	4-Pole Neutrik Female Cable Mount Speakon Connector NL4FX.....	8.39B
00384820	NA4LJX - Neutrik Speakon to 1/4" Adapter.....	12.99B

# PROCO AUDIO PRODUCTS

## CHAMPION INSTRUMENT

MODEL	LENGTH
PSLG3	3'
PSLG6	6'
PSLG10	10'
PSLG15	15'
PSLG18	18'
PSLG25	25'



PRICE
\$9.30
10.80
11.85
13.80
14.98
17.70

## EXCELLINES INSTRUMENT

Sound Quality at an affordable price.

MODEL	LENGTH	
PEG1	1'	
PEG3	3'	
PEG5	5'	
PEG10	10'	
PEG15	15'	
PEG186	18.5'	1 RIGHT ANGLE PLUGS
PEG186L	18.5'	1 RIGHT ANGLE PLUGS
PEG25	25'	
PEG06LL	6"	2 RIGHT ANGLE PLUGS



PRICE
\$9.30
10.50
11.45
13.25
16.40
17.85
20.85
20.40
15.00

## STAGEMASTER INSTRUMENT

Inexpensive, quality cable.

MODEL	LENGTH
PSEG1	1'
PSEG3	3'
PSEG6	6'
PSEG10	10'
PSEG15	15'
PSEG18	18'
PSEG25	25'



PRICE
\$5.40
6.30
7.80
8.85
10.80
12.00
14.70

## LIFE LINES INSTRUMENT

Noise reducing, cleaner sounding cable.

MODEL	LENGTH
PLC10	10'
PLC186	18.5'



PRICE
\$31.40
38.40

## MICROPHONE CABLES

MODEL	DESCRIPTION	PRICE
PM10	MASTER MIKE, 10', LO-Z	\$38.75
PMN20	MASTERMIKE, 20', LO-Z	47.05
PM30	MASTERMIKE, 30', LO-Z	56.85
PM50	MASTERMIKE, 50', LO-Z	73.65
PM100	MASTERMIKE, 100', LO-Z	120.60
PSMM5	STAGEMASTER, 5', LO-Z	10.75
PSMM10	STAGEMASTER, 10', LO-Z	12.60
PSMM15	STAGEMASTER, 15', LO-Z	10.75
PSMM20	STAGEMASTER, 20', LO-Z	17.70
PSMM25	STAGEMASTER, 25', LO-Z	10.75
PSMM30	STAGEMASTER, 30', LO-Z	24.00
PSMM50	STAGEMASTER, 50', LO-Z	33.60
PEXM5	EXCELLINES, 5', LO-Z	20.55
PEXM15	EXCELLINES, 15', LO-Z	24.80
PEXM25	EXCELLINES, 25', LO-Z	27.40
PEXH20	EXCELLINES, 20', HI-Z	28.95
PM20SW	MASTERMIKE, 20', LO-Z WITH SWITCH	70.65

## SPEAKER CABLES

MODEL	DESCRIPTION	PRICE
PS1450	EXCELLINES, 50', 14-GAUGE	\$77.00
PS1630	EXCELLINES, 30', 16-GAUGE	37.50
PS1650	EXCELLINES, 50', 16-GAUGE	52.75
PSZF1630	STAGEMASTER, 30', 16-GAUGE	27.70
PSZF1610	STAGEMASTER, 10', 16-GAUGE	15.80
PSZF1650B	STAGEMASTER, 50', 16-GAUGE 1/4"-MDP	50.45
PBA1	EXCELLINES, 1', 16-GAUGE 1/4"-MDP	31.20

## AP PATCH CORDS

APC125	1' Stereo Patch Cord (10 per pack)	\$20.40
APC245	2' Stereo Patch Cord (8 per pack)	23.90

## FOOT SWITCHES



SINGLE		PRICE
SF2479	Signal Flex	\$35.80
FS1	Roland	32.00*
RSW3010	Ruby	26.85
4049	Fender	22.954
4052	Fender	57.40
FX010	Johnson	19.20
FSC384	Hosa	18.80
RFS1	Rocktron	39.00
DOUBLE		PRICE
SF2480	Signal Flex	\$52.50
RSW3020	Ruby	29.55
4056	Fender	68.65
4051	Fender, Vintage	68.85
FX020	Johnson	34.30
FSC385	Hosa	24.10
RFS2	Rocktron	49.00
MOMENTARY		PRICE
SF2481	Unlatch	\$33.10
SFFS101	Pro Single	40.45
FSC501	Latch	27.40
FSC502	Single (open)	27.40
FSC503	Single (closed)	27.40
SF2482	Latch	32.40
FSC604	Open	27.85
BOSS		PRICE
FSSU	Unlatch	\$40.50B
FSSL	Latch	40.50B

www.procosound.com

## ON/STAGE

### STAGE SNAKE BOXES

These stage boxes provide (XLR) female input channels plus 4 (XLR) male returns. All inputs and returns feature locking connections for a secure fit. Heavy-duty all metal chassis box. Comes with a built-in easy carrying handle and protective black nylon bag.

SNK8450	50' 8 mic + 4 returns	\$149.95B
SNK84100	100' 8 mic + 4 returns	209.95B
SNK12450	50' 12 mic + 4 returns	189.95B
SNK124100	100' 12 mic + 4 returns	269.95B
SNK16450	50' 16 mic + 4 returns	219.95B
SNK164100	100' 16 mic + 4 returns	319.95B
SNK24450	50' 24 mic + 4 returns	319.95B

### INSTRUMENT CABLES

IC3	Instrument Cable, 3 ft.	\$9.99 ea.
IC6	Instrument Cable, 6 ft.	11.99 ea.
IC10	Instrument Cable, 10 ft.	14.99 ea.
IC20	Instrument Cable, 20 ft.	18.99 ea.
IC20BR	20 ft. Braided Cable	27.99 ea.

### MICROPHONE CABLES

MC1210XLR	Mic Cable, 10 ft. XLR	\$13.99 ea.
MC1220XLR	Mic Cable, 20 ft. XLR	16.99 ea.
MC1225XLR	Mic Cable, 25 ft. XLR	19.99 ea.
MC1250XLR	Mic Cable, 50 ft. XLR	52.99 ea.
MC1225HZ	Mic Cable, 25 ft. Hi-Z	26.99 ea.

### SPEAKER CABLES

SP1425	Speaker Cable, 25 ft.	\$37.99 ea.
SP1450	Speaker Cable, 50 ft.	55.99 ea.
SP1425SS	Speakon® Speaker Cable, 25 ft.	68.99 ea.
SP1450SS	Speakon® Speaker Cable, 50 ft.	96.99 ea.

# PERFEKTION CABLES



## STRAIGHT

PM101	10'	Molded Ends - Black.....	\$3.99
PP103	10'	Metal Ends - Black.....	6.30
PM202	20'	Molded Ends - Black.....	5.98
PP203	20'	Metal Ends - Black.....	7.98
PP305	20'	Brass Ends - Black.....	9.00

## COILED

PP204	20'	Metal Ends - Black.....	\$9.30
PP306	20'	Brass Ends - Black, Noiseless.....	9.45

## SPEAKER

PM803	3'	18 Gauge Molded Ends.....	\$6.00
PM820	20'	18 Gauge Molded Ends.....	10.50
PM830	30'	18 Gauge Molded Ends.....	15.75

## PATCH

Color coded 1 ft. cords. Ideal for connecting effect pedals.

PM618	1.5'	Package of six, straight, asst. colors.....	\$11.85
PM616	1'	RA/RA pack of 6 colors.....	8.85
CFS606		Package of six, right angle, molded.....	14.55
IRG6005		Package of six, right angle, metal.....	26.30
CI350P6	6"	RA/RA.....	7.55
PWCGTP305	6"	RA/RA (3 Pack).....	21.25
IRG101	1'	RA/RA, Metal.....	6.20
SLP2		LL Plug, 2 Pack.....	14.05
GPP146		Z Plug, Coupler.....	4.85
S6P48	6"	Patch Cable, right angle in 48 piece fishbowl.....	195.05

## PEAVEY SPEAKER CABLES

00576080	PV 25'	16 Gauge S/S Speaker Cable.....	\$19.79
00576090	PV 50'	16 Gauge S/S Speaker Cable.....	31.19

# LIGHT SNAKE CABLES



Illuminated cables. Ends of cable light up when properly connected.

STUSBG10	USB - Instrument, 10'	.....	\$69.99
STUSBXLR10	USB - XLR, 10'	.....	69.99
STUSBIP0D6	USB "A" - IPOD, 6"	.....	49.99
USBMIDI10	USB - Midi, 10'	.....	79.99
STUSBEXT6	USB Extension, 6'	.....	49.99
STUSBAB6	USB A-B, 6'	.....	49.99
STUSBA6	USB A-A, 6'	.....	49.99

## MICROPHONE CORDS



PE610	20'	XLR - 1/4"	.....	\$8.25
CMI125	25'	XLR - XLR.....	.....	25.85

## PEAVEY MICROPHONE CORDS

00576230	PV 20'	LOZ Mic Cable.....	\$20.69
00576240	PV 25'	LOZ Mic Cable.....	22.49

# PLANET WAVES/D'ADDARIO CABLES



PWP047E	1/4"	Male Stereo to 1/8" Female Stereo.....	\$11.25
PWP047T	1/4"	Female to 1/4" Female.....	9.20
PWP047Z	XLR Male	to 1/4" Female Balanced.....	9.20
PWP047BB	XLR Female	to 1/4" Female Balanced.....	11.25
PWP047AA	1/4"	Male Balanced to XLR Female.....	12.25
PWP035N	SpeakOn®	to 1/4" Female Mono.....	28.05
PWP047C	1/8"	Male Stereo to Dual RCA Female.....	11.25

# AMERICAN STAGE CABLES



PWAMSG10	10"	Instrument Cables.....	\$40.80
PWAMSG15	15"	Instrument Cables.....	51.00
PWAMSG20	20"	Instrument Cables.....	61.20
PWAMSG30	30"	Instrument Cables.....	71.40

## Single Conductor Instrument Cables

ITEM #	LENGTH	RETAIL
PWCGT05	5 ft.....	\$14.75
PWCGT10	10 ft.....	17.35
PWCGT15	15 ft.....	19.95
PWCGT20	20 ft.....	21.70

## Right Angle Single Conductor Instrument Cables

ITEM #	LENGTH	RETAIL
PWCGTRA10	10 ft.....	\$17.35
PWCGTRA20	20 ft.....	21.70

SpeakOn® is a registered trademark of Neutrik AG.

# PLANET WAVES/D'ADDARIO ADAPTORS/CABLES

## Speaker Cables

Nickel-plated plugs with 8 compression springs ensure positive connection into 1/4" speaker jacks.

Ultra-fine stranded premium quality copper 16 AWG conductor offers maximum signal transfer and flexibility.

### 1/4" Speaker Cables, Classic Series

<b>PWCSPK05</b>	5 Ft.....	\$14.75
<b>PWCSPK10</b>	10 Ft.....	19.00
<b>PWCSPK25</b>	25 Ft.....	33.00

### 1/4" Speaker Cables, Custom Series

<b>PWS05</b>	5 Ft.....	\$30.60
<b>PWS10</b>	10 Ft.....	35.70
<b>PWS25</b>	25 Ft.....	51.00



## SpeakOn® Speaker Cables

<b>PWS005</b>	5 Ft.....	\$40.80
<b>PWS010</b>	10 Ft.....	45.90
<b>PWS025</b>	25 Ft.....	71.40

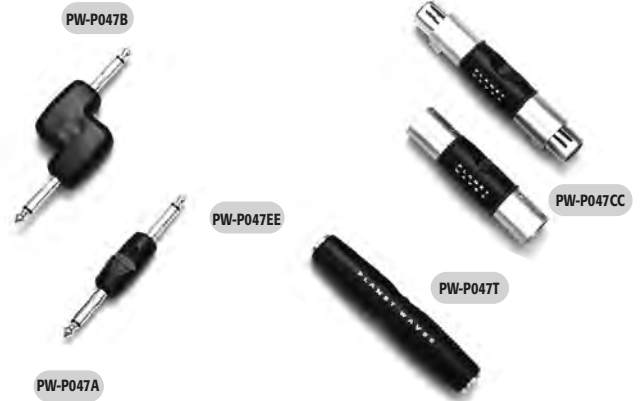

<b>PWP047C</b>	1/8" Male Stereo to Dual RCA Female.....	\$11.25
<b>PWP047T</b>	1/4" Female Stereo.....	9.20
<b>PWP047A</b>	1/4" Male Mono (Inline).....	10.20
<b>PWP047B</b>	1/4" Male Mono (Offset).....	12.25
<b>PWP047CC</b>	XLR Female.....	11.25
<b>PWP047EE</b>	XLR Male.....	9.20



## Headphone Ext.

<b>PWEXTHD10</b>	10 Ft.....	\$31.99
<b>PWEXTHD20</b>	20 Ft.....	39.99

www.planetwaves.com

## HOSA AC LINE CORDS



<b>PWC143</b>	Grounded, 3 wire, 3 foot.....	\$8.50
<b>PWC148</b>	Grounded, 3 wire, 6 foot.....	11.15
<b>PWC178</b>	Ungrounded, 2 wire, 6 foot.....	12.60
<b>PWC148R</b>	Right Angle, 8 foot.....	12.25
<b>PWC415</b>	14 AWG, 15 Foot.....	31.60
<b>PWC425</b>	14 AWG, 25 Foot.....	49.30
<b>PWC450</b>	14 AWG, 50 Foot.....	93.75
<b>PWP426</b>	18 AWG, 8 Foot.....	8.95
<b>PWC4015</b>	Grounded, IEC, 14 AWG, 1.5 Foot.....	7.50
<b>PWC403</b>	Grounded, IEC, 14 AWG, 3 Foot.....	10.05
<b>PWA486</b>	R/A Edison Adaptor.....	\$5.10
<b>PWA421</b>	Grounded, IEC Adaptor.....	5.60
<b>YAC407</b>	18 AWG, 1 1/2 foot Grounded Y Cable.....	10.65
<b>YAC406</b>	14 AWG, 1 1/2 foot Grounded Y Cable.....	14.80
<b>PWP461</b>	Polarized, 8 foot.....	9.70
<b>PWC1405</b>	6" Grounded.....	6.55
<b>PWC141</b>	1' Grounded.....	6.80
<b>PWC1415</b>	1.5' Grounded.....	7.05
<b>PWX403</b>	Grounded, Extension, 14 AWG, 3 Foot.....	11.65
<b>PWA421</b>	Power Adaptor.....	5.60

**FAX & E-MAIL ORDERS  
FOR PRINTED MUSIC  
WILL GET AN EXTRA  
5% DISCOUNT**

**FAX:**

**(708) 496-2130**

**(888) 983-5537**

**E-MAIL:**

**sales@harristeller.com**

# PLANET WAVES/D'ADDARIO CABLES

## Pedal Board Cable Kit

The Planet Waves Pedal Board Kit is the ultimate solution for custom-wiring your pedal board or rack gear. Inferior patch cables can cause signal loss and undesirable coloration to your sound. Planet Waves plugs and cables are specially designed to provide the most accurate and reliable reproduction of your sound from guitar to amp and all points in between. Includes 10' of cable, 10 right-angle plugs and a mini cable cutter.

- Solderless plugs connect to cable in seconds, creating exact, required lengths easily!
- 24k gold-plated plugs for improved signal flow and corrosion resistance.

**PWGPKIT10** Pedal Board Cable Kit.....\$96.90

## Custom Series with Compression Spring Plugs



**PWGCS05** 5' 1/4" Instrument Cable.....\$29.00  
**PWGCS10** 10' 1/4" Instrument Cable .....24.00  
**PWGCS15** 15' 1/4" Instrument Cable .....39.00  
**PWGCS20** 20' 1/4" Instrument Cable .....44.00  
**PWGRACS10** 10' 1/4" Right Angle (One Side) Instrument Cable.....34.00

## Mono Twisted Pair Instrument Cables



### Lengths Available:

5 Ft. **PWG05**.....\$25.50  
 10 Ft. **PWG10**.....30.60  
 15 Ft. **PWG15**.....35.70  
 20 Ft. **PWG20**.....40.80  
 30 Ft. **PWG30**.....51.00

## Stereo Twisted Pair Instrument Cables



### Lengths Available:

10 Ft. **PWGS10**.....\$35.70  
 25 Ft. **PWGS25**.....45.90

## Right-Angle Twisted Pair Instrument Cables

### Lengths Available:

10 Ft. **PWGRA10**.....\$30.60  
 20 Ft. **PWGRA20**.....40.80

## Circuit Breaker

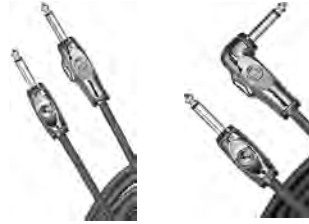

Item #  
**PWAG10** 10 Ft. ....\$40.80  
**PWAG15** 15 Ft. ....45.90  
**PWAG20** 20 Ft. ....51.00

## The Right-Angle Circuit Breaker™

Item #  
**PWAGRA10** 10 Ft. ....\$40.80  
**PWAGRA20** 20 Ft. ....51.00

## Single Conductor Instrument Cables

- Patented nickel plated plugs with 8 compression springs ensure positive connection into standard 1/4" (6.35 mm) jacks.
- Special coaxial cable design provides extra-clean signal and low capacitance.
- Molded connectors provide extra protection over ordinary plugs.

## Single Conductor Instrument Cables

Item #  
**PWCGT05** 5 Ft. ....\$14.75  
**PWCGT10** 10 Ft. ....17.35  
**PWCGT15** 15 Ft. ....19.95  
**PWCGT20** 20 Ft. ....21.70



## Right Angle Single Conductor Instrument Cables

**PWCGTRA10** 10 Ft. ....\$17.35  
**PWCGTRA20** 20 Ft. ....21.70



# AMERICAN STAGE CABLES

Our innovative patented GeoTip provides a seamless and secure connection between your guitar and amp. It all adds up to tone: the best materials, customized design and U.S.A. precision manufacturing combine to deliver a truly unique, professional performance cable.

**PWAMSGRA10** 10' Instrument Cable, Rt./Angle to Straight.....\$44.99  
**PWAMSGRA20** 20' Instrument Cable, Rt./Angle to Straight.....59.99  
**PWAMSGRR10** 10' Instrument Cable, Rt./Angle to Rt./Angle.....49.99  
**PWAMSGRR20** 20' Instrument Cable, Rt./Angle to Rt./Angle .....69.99



**PWAMSG10** 10' Instrument Cable 1/4" to 1/4" .....\$40.80  
**PWAMSG15** 15' Instrument Cable 1/4" to 1/4" .....51.00  
**PWAMSG20** 20' Instrument Cable 1/4" to 1/4" .....61.20  
**PWAMSG30** 30' Instrument Cable 1/4" to 1/4" .....71.40

## 1/4" Patch Cables



- Gold-plated plugs with patent-pending compression springs ensure positive connection into standard 1/4".

## Patch Cables (Sold in pairs)

Item # Length  
**PWPC01** 1 Ft. ....\$17.35

## Right-Angles Patch Instrument Cables (Sold in pairs)

Item # Length  
**PWPRA205** 6 in. ....\$40.80

## Right-Angle Single Conductor Patch Cables

Item # Length  
**PWCGTP305** 0.5 (3-pack) .....\$21.70





# PLANET WAVES/D'ADDARIO CABLES

## Custom Instrument Cable Kit

- Based on our best-selling pedal board kit
- Allows custom cable lengths from instrument to pedals to amplifier
- Includes 50 ft. of cable, 6 right-angled 1/4" plugs, and 4 straight 1/4" plugs
- Gold-plated plugs and a solderless connection design for easy construction
- Cable features a 24 gauge OFC conductor in a low capacitance design with two layers of impenetrable shielding
- Also includes a mini cable cutter



PWGPKIT50.....\$122.40



## Custom Series Microphone Cables

- 24-karat gold-plated plugs ensure premium sound quality and corrosion resistance.
- Special double-insulated/double-shielded cable provides cleanest signal available while eliminating hum and triboelectric noise.

provides cleanest signal available while eliminating hum and triboelectric noise.

- Exclusive Planet Waves overmolded connectors provide extra protection with unmatched strain relief.

### XLR Male to XLR Female

<b>PWM05</b>	5 Ft.....	\$30.60
<b>PWM10</b>	10 Ft.....	40.80
<b>PWM25</b>	25 Ft.....	56.10



## Classic Series Microphone Cables

- Nickel-plated brass connectors offer reliable, corrosion-resistant contact.
- Flexible, molded collar for outstanding strain relief.

- Heavy-duty, plated, copper-braided shield offers 95% shielding coverage.

### XLR Male to XLR Female

<b>PWCMIC10</b>	10 Ft.....	\$22.00
<b>PWCMIC25</b>	25 Ft.....	30.35
<b>PWCMIC50</b>	50 Ft.....	51.00

### XLR Female to 1/4"

<b>PWCGMIC25</b>	25 Ft.....	\$30.35
------------------	------------	---------

## EVH CORDS



<b>EVH1</b>	1' S/S Cable .....	\$29.99
<b>EVH6</b>	6' S/S Cable .....	34.99
<b>EVH14</b>	14' S/S Cable .....	39.99
<b>EVH20</b>	20' S/S Cable .....	49.99



### Swivel XLR Microphone Cable

<b>PWMS25</b>	25 Ft.....	\$61.20
---------------	------------	---------

### Swivel XLR Male to Stereo 1/4" (6.35mm) Connectors

<b>PWGMMS10</b>	10 Ft.....	\$43.85
-----------------	------------	---------

## AMERICAN STAGE MICROPHONE CABLES

State of the art Crimped Connector Technology for outstanding performance an unmatched durability. 22 gauge OFC twisted pair conductors for optimal signal transfer and flexibility. 98% copper braid shielding for superior EMI rejection. Neutrik made plugs built to Planet Waves exclusive design. Made in USA.

<b>PWAMSM10</b>	10 ft. XLR Male to XLR Female .....	\$59.99
<b>PWAMSM25</b>	25 ft. XLR Male to XLR Female .....	89.99

# DI MARZIO CABLES



### HIGH DEFINITION SPEAKER CABLES

12-gauge OFHC copper with Neutrik 1/4 inch phone ends. (single length).

<b>EP1803</b>	3-foot length .....	\$59.95
<b>EP1804</b>	4-foot length.....	69.95
<b>EP1800R</b>	Bulk 250-foot spool (76.2 meters) .....	6.00B/FT
<b>EP2715Y</b>	15 foot Stereo Y .....	69.95

### INSTRUMENT CABLES

American-made overbraid cable, straight Switchcraft ends\*, specify color and length. Black (BK), Red (RD), Tweed (TW), Black/Gray (BKGY), Black/Pink (BKPK), Blue/Pink (BLPK), Turquoise/Pink (TQPK), Electric Blue (EB), Golden Rod (GR), Black Red (BKR), Black Blue (BKB), Black Yellow (BKY), Black Purple (BKPU).

<b>EP1710</b>	10-foot length .....	\$39.00
<b>EP1715</b>	15-foot length .....	43.95
<b>EP1718</b>	18-foot length .....	46.95

### METALLIC INSTRUMENT CABLES

American-made overbraid cable, straight Switchcraft ends\*, specify color and length. Chrome (SM) or Gold (GM).

<b>EP1710</b>	10-foot length.....	\$37.50
<b>EP1715</b>	15-foot length .....	51.50



### GUITAR CABLES

American-made custom cable.

<b>EP1610</b>	Black, 10-foot length .....	\$27.90
<b>EP1618</b>	Black, 18-foot length .....	33.90

### JUMPER CABLES

Available in Black

<b>EP17J06BK</b>	6" R.A. Plugs .....	\$19.50
<b>EP17J12BK</b>	12" R.A. Plugs .....	19.50

### INSTRUMENT & JUMPER CABLES

American made overbraid cable in bright neon colors. Available neon colors: (G) Green, (P) Pink, (O) Orange, (Y) Yellow.

1/4 - 1/4

<b>EP1710</b>	10' .....	\$39.00
<b>EP1718</b>	18' .....	43.95

1/4 RA - 1/4 RA

<b>EP17J06</b>	6" .....	\$19.50
<b>EP17J12</b>	12" .....	20.00

## Direct Interface Boxes

### Professional and portable—multiple units fit in one rack space.



### PDI Passive Direct Interface

03001340 PDI (Passive Direct Interface).....\$99.99B

- The PDI is a classic Passive Direct Interface box
- The transformer used in the PDI is the reason for its outstanding performance
- The PDI provides the high input impedance, ground isolation and signal attenuation needed to connect a variety of instruments to a mixer mic input
- Quality transformer with faraday shield
- Instrument input and thru
- Stereo input for electronic instruments
- Balanced mono output
- Ground lift switch
- Mono/Stereo input selector



### HB2 Headphone Amplifier

18025180 HB-2 (Headphone Amp) w/ Power Supply.....\$121.99B

- The HB-2 is a versatile headphone amplifier with applications both on and off stage
- After the gig, the HB-2 makes a compact practice amplifier
- Up to 4 pairs of stereo headphones with a 32-Ohm or greater rating can be connected to the HB-2 using the appropriate headphone Y-cord splitters
- Mono instrument input
- 1/4" and 1/8" (3.5mm) stereo inputs
- Stereo or mono operation
- Powerful headphone output
- Adjustable limiter for hearing protection
- 1/4" thru for linking multiple units
- 15 VDC input



### KOSMOS®-M Subharmonic Bass Processor

18025250 Kosmos M w/ Power Supply.....\$105.99B

- The sub-harmonic generator in the Kosmos processor enhances the sound of instruments by generating a copy of the signals in their bass range but shifted an octave lower
- Kosmos M places this circuitry in a phantom powered processor that can be connected in line between a dynamic microphone and the mix console
- The mic input on the Kosmos M is designed for high volume applications so a pad is not required
- Kosmos sub-harmonic generation technology with damping selector switch
- XLR mic input
- Phantom power or 15 VDC input (option)



### USB-P USB Audio Device

03001370 USB-P (USB Audio Interface w/ Transformer).....\$79.99B

- The USB-P is a USB audio device with transformer isolated balanced stereo outputs for connecting a computer to a sound system
- As the name implies, the USB-P connects to the USB port of the computer and appears as a stereo output device
- The dual transformers in the USB-P provide balanced outputs and ground isolation required when interfacing a computer to a sound system
- Standard USB class compliant audio device
- No special drivers required
- Transformer isolation
- Ground lifted balanced outputs
- Playback only
- USB powered
- Stereo/Mono output switch

## DIRECT BOXES



### CONQUEST

Transformer isolated direct boxes. Connect any electronic instrument directly to the mixing console for PA or recording.

**EDB2** Passive .....\$ 61.95  
**BPH2002** Active .....143.90



### PRO CO

Connects instrument to mixing console for PA or recording.

**PDB1** .....\$181.25  
**CB1** .....105.95



### HOSA

**DIB443** Passive .....\$ 31.50  
**DIB307A** Active .....130.85



### ON/STAGE

**DB500** Passive .....\$54.99

## ART



### XDIRECT

### DIRECT BOXES

High quality interface that allows you to connect your instrument, line, or even speaker level audio signals to any balanced input. Extremely wide, flat frequency response and can handle high input signal levels while still maintaining an isolated, balanced low impedance output.

**XDIRECT** Active.....\$50.00B  
**ZDIRECT** Passive .....35.00B

## LR BAGGS

### PARA ACOUSTIC DI



Class A FET input stage, a phantom powerable XLR, a 5-band EQ with two tunable bands and phase reversal.

**PARA01** .....\$249.00B

Full isolation DI/floor box

**VDI** .....\$399.00B

## DUNLOP MXR A/B BOX



MXR A/B Box allows you to deliver our instrument's signal to two separated output. Use it to select different amps or to use both at the same time with different effects. Use the Thru output to connect a tuner, an amplifier, or any device which needs to receive the signal always.

**MXRM196** .....\$85.70B

### PASSIVE DIRECT BOX

The PDB allows connection of a music source to an instrument amplifier while simultaneously patching it to a mixer. It automatically balances and matches the line level output.

### DUAL PASSIVE DIRECT BOX

The dPDB dual passive direct box features two high-quality direct boxes in one portable enclosure. It is a rock solid, roadworthy DI connection of the outputs of electronic musical instruments (or other audio sources) to the balanced inputs of mixer consoles.

**PDB** .....\$45.00B  
**DPDB** .....60.00B

## A/B BOXES



### MORLEY

Effects Loop Corrector corrects the variations in FX Leaps signals that exist from amp to amp.

**ELC** .....\$156.00



### TWIN MIX

The Twin Mix is designed to route two input signals to two output sources. Each input has its own level control to balance different input levels. Each input also has a mute switch.

**TM** .....\$166.00



### ABY SELECTOR/COMBINER

Route one input to two outputs or two inputs to one output. Then select or combine as needed. True Bypass.

**ABY** .....\$118.00  
**ABYMIX** ABY/Mixer.....166.00



### ABC SELECTOR/COMBINER

Route one input to three outputs or three inputs to one output. Then select or combine as needed. True Bypass.

**ABC** .....\$188.00

## ART



### XDIRECT

### DIRECT BOXES

High quality interface that allows you to connect your instrument, line, or even speaker level audio signals to any balanced input. Extremely wide, flat frequency response and can handle high input signal levels while still maintaining an isolated, balanced low impedance output.

**XDIRECT** Active.....\$50.00B  
**ZDIRECT** Passive .....35.00B

## LR BAGGS

### PARA ACOUSTIC DI



Class A FET input stage, a phantom powerable XLR, a 5-band EQ with two tunable bands and phase reversal.

**PARA01** .....\$249.00B

Full isolation DI/floor box

**VDI** .....\$399.00B

## DUNLOP MXR A/B BOX



MXR A/B Box allows you to deliver our instrument's signal to two separated output. Use it to select different amps or to use both at the same time with different effects. Use the Thru output to connect a tuner, an amplifier, or any device which needs to receive the signal always.

**MXRM196** .....\$85.70B

### PASSIVE DIRECT BOX

The PDB allows connection of a music source to an instrument amplifier while simultaneously patching it to a mixer. It automatically balances and matches the line level output.

### DUAL PASSIVE DIRECT BOX

The dPDB dual passive direct box features two high-quality direct boxes in one portable enclosure. It is a rock solid, roadworthy DI connection of the outputs of electronic musical instruments (or other audio sources) to the balanced inputs of mixer consoles.

**PDB** .....\$45.00B  
**DPDB** .....60.00B

## A/B BOXES



### MORLEY

Effects Loop Corrector corrects the variations in FX Leaps signals that exist from amp to amp.

**ELC** .....\$156.00



### TWIN MIX

The Twin Mix is designed to route two input signals to two output sources. Each input has its own level control to balance different input levels. Each input also has a mute switch.

**TM** .....\$166.00



### ABY SELECTOR/COMBINER

Route one input to two outputs or two inputs to one output. Then select or combine as needed. True Bypass.

**ABY** .....\$118.00  
**ABYMIX** ABY/Mixer.....166.00



### ABC SELECTOR/COMBINER

Route one input to three outputs or three inputs to one output. Then select or combine as needed. True Bypass.

**ABC** .....\$188.00



### QUAD BOX

This unique switch allows easy control of two guitars and two amps. True Bypass.

**QUAD** .....\$178.00



### TRIPLER

Route one guitar to three amps. Then, select or combine any combination of amps. Boost knob adds up to 20dB clean boost to all channels.

**TRIPLER** .....\$206.00

## MORLEY MAN



### MORLEY MAN FX DISTORTION BOOST

Classic Analog overdrive style distortion with boost. Separate footswitches for distortion on/off and distortion boost. Boost works when distortion is engaged. Great as stand alone distortion or to enhance and boost your amps distortion. Dual LED's show when distortion and boost are on/off. True Tone Buffer ensures signal integrity and guitar tone. Helps drive longer cable runs.

**MDB** .....\$206.00

## BUFFER BOOST



### BUFFER BOOST

Morley's TrueTone Buffer circuit maintains level and tone. Older effects come to life and you can run longer cables with no signal loss.

**MMBB** .....\$144.00

# SHADOW PICK-UPS & TRANSDUCERS

## GUITAR PICK UPS



**SH1990** .....\$174.95  
Acoustic Guitar Bridge Pickup System. Fits 2.3 mm bridge slot. System includes endpin and 3.5 mm mini-plug. Six separate string sensors. Easy to install.

**SHNMGEP** .....\$246.90  
NanoMAG pickup with endpin preamp for acoustic guitar. Easy installation without damaging your guitar. The NanoMAG is a small size magnetic pickup that fits at the end of the fingerboard and can also produce a sweet blues or jazz sound.

**SHHBTCTB** .....\$69.95  
For curved top guitars, black  
**SHHBTCTC** .....\$69.95  
For curved top guitars, cream  
**SHHBTFTB** .....\$69.95  
For flat top guitars, black  
**SHHBTFTC** .....\$69.95  
For flat top guitars, cream

The Shadow SH E-Tuner HB responds quickly and precisely and thanks to its chromatic functioning, allows for all conceivable alternate tunings, including open tunings. Its multicolored LED's are unfailingly easy to read, even in bright surroundings.

**SH330** .....\$99.95  
Single coil pickup. Wood case. Attached 12 ft. cable.



**SH066** .....\$124.95  
Made for professional OEM use. Six individual piezo pickups provide rich output.

**SHHBTTRB** .....\$69.95  
For tremolo guitars – black

**SHHBTTRC** .....\$69.95  
For tremolo guitars – cream

The Shadow SH E-Tuner HB responds quickly and precisely and thanks to its chromatic functioning, allows for all conceivable alternate tunings, including open tunings. Its multicolored LED's are unfailingly easy to read, even in bright surroundings.



**SH1110** .....\$169.95  
Sensor line pickup mounts invisibly under original saddle. Endpin and 3.5 mm plug incl.



**SH099** .....\$94.95  
Fits under bridge saddle/8 mm thick, 6 separate string sensors.

## CLASSICAL GUITAR PICK UPS



**SH1900A** .....\$204.95  
Unsurpassed sound accuracy and sensitivity. Mounts in seconds. No drilling or wiring. No damage to your guitar.



**SH0905** .....\$129.95  
Pickup fits all bridges with 2.3 mm slot. Six separate sensors.



**SH076** .....\$124.95  
Pickup fits all bridges with 8 mm slot. Six separate sensors.



Fits under bridge saddle.  
**SH060 with Jack** .....\$94.95

## ACTIVE ACOUSTIC



Undersaddle pick up with pre amp & cord.  
**SHNFXAC** .....\$234.95

## STRINGED INSTRUMENT PICK UPS

**SHNFXEQTUK** .....\$234.95  
**Uke Pickup/Tuner.** The SH Onboard Tuner is an automatic chromatic tuning device for permanent installation inside ukuleles and guitars. Thanks to its built-in, high-quality microphone, the tuner works with absolute precision and reliability.

**SH925** .....\$189.95  
New Generation **Arch-top Mandolin Pickup.** Compensated bridge w/4 separate sensors, ebony base incl. Easy to install.

**SH926** .....\$235.95  
Same as SH925. Comes w/ variable impedance volume control.

**SH927NMG4** .....\$373.99  
4 NanoMAG pickups – one for each pair of strings on your **mandolin.** Adjustable output for each pair of strings by 4 independent gain controls. No click-sounds. 100% hum-free active preamp. Full tone control: volume, bass and treble controls at the instrument.

## ACTIVE PICK UPS

Senses vibration of bridge and body. No modification required.

**SH945NFX** Violin .....\$249.95  
**SH955NFX** Cello .....\$299.95  
**SH965NFX** Bass .....\$349.95



**SH920** .....\$179.95  
**Mandolin pickup system.** 4 sep. piezo pickups & volume control, bridge for flat and archtop.



**SH940** .....\$184.95  
**Violin bridge w/built-in pickup,** vol. control, 12 ft. cable. Mounts like chin rest.



**SH941** .....\$169.95  
Extremely lightweight. Fits between bridge wing & foot. Perfect sound reproduction.



**SH3000** .....\$149.95  
Easy mount violin transducer with chin rest style volume control.

**SHSNT** .....\$59.95  
**SH Sonic Tuner.** Soundhole tuner, automatic, chromatic soundhole for acoustic instruments. Precise tuning. Easy to read LED display. Installs in minutes. Powered by a high quality built-in microphone. On/Off switch.

**SH950** .....\$272.55  
**Double bass pickup.** Four sensors provide pure sound, either bowed or plucked.

**SH951** .....\$164.95  
**Single Bass.**

**SH930** .....\$169.95  
**Five-string banjo pickup.** Volume control & 12 foot cable included. Easy to install.

## STRINGED INSTRUMENT TRANSDUCERS

**SH713** .....\$109.95  
Triple-multipurpose transducer. Female 1/4" connector output (6.3mm).



**SH3001** .....\$99.95  
Violin transducer. Mounts to bridge with adhesive.



**SH2001A** .....\$99.95  
Quick mount removable transducer w/adhesive & 12 foot cable included.



**SH710** .....\$64.95  
Small dot transducer.



**SH720** .....\$89.95  
Small twin spot.



**SH2000A** .....\$129.95  
Quick mount removable transducer for stringed instruments. Volume and tone controls. 12 foot cable and reusable mounting adhesive included. Easy to use.



**SH711** .....\$64.95  
Single-multipurpose transducer. Female 1/4" connector output (6.3mm).



**SH2500E** .....\$129.95  
Permanent mount transducer. Mounts invisibly inside guitar. Suitable for all types of strings.



**SH499PB** .....\$99.95  
Electric bass split humbucker. Vintage sound with more power.

In-Line Pre Amp built into cable  
**SHACP1** Acoustic Guitar .....\$165.95

PRICES MAY VARY DUE TO EURO/DOLLAR FLUCTUATION  
[www.shadow-electronics.de](http://www.shadow-electronics.de)

# SHADOW PICK-UPS



**SHAZ48** .....\$194.95  
Jazz guitar humbucker designed by Attila Zoller. Floats between body and strings by cleanly fastening to the fingerboard. Clear sound in all positions.

## ACOUSTIC AND ELECTRIC BASS PICKUPS



**SH065** .....\$134.95  
Five string acoustic bass guitar pickup.

## ACCESSORIES



**SH001** .....\$12.95  
Transducer adhesive.



**SH006** .....\$21.95  
12 ft. cable phone plug to mini-plug.



**SHSD2** .....\$84.95  
Stereo snare drum trigger for head and rim.

**SHSD3** .....\$64.95  
Tom-Tom trigger.



**SHV1** .....\$59.95  
Single violin transducer. Mounts between wing and foot of the bridge. 1/4" jack connector.  
**SHV2** Twin .....\$99.95

## STOMPING BASS PEDAL

The Stompin' Bass has a unique and compact design that is very robust and road worthy with a high quality Shadow NanoMag pickup system. It adds dynamic percussion for solo artists and bands alike. The Stompin' Bass is played simply by tapping the surface with your foot, and its angled design allows for hours of tireless use.  
**SHSTOMP** .....\$239.99



**SHSB2** .....\$104.95  
Twin bass transducer. Mounts between wing and foot of the bridge. 1/4" jack connector.  
**SHSB1** Single .....\$59.95



**SHSC1** .....\$99.95  
Twin cello transducer. Mounts between wing and foot of the bridge. 1/4" jack connector.



**SHSD5** .....\$284.95  
Pack of 5 pieces SH-SD3.



**SHB1** .....\$104.95  
Banjo twin bridge transducer. Mounts under the bridge foot.

## END PINS



### END PINS

**EB6331** Chrome — 1/4", E. Ball .....\$12.00B  
**SH012** Chrome — 1/4", Stereo, Shadow .....42.95  
**EP1300** Chrome — 1/4", DiMarzio .....19.95  
**MM112** Chrome — 1/4", Mighty Mite .....8.95  
**WDENDPIN** 1/4" Anderson.....15.00  
**WDEPTOOL** End Pin Tool .....2.50  
**RP390C** Chrome, 3 Hole Flange.....16.55  
**RP391** Chrome, Heavy Duty .....18.50  
**RP394C** Chrome, Solid Body.....12.65  
**GTJPT1** Jack/Pot Tool .....18.95

### GUITAR JACK AND FERRULE TOOL

Easily tighten loose pick-up jacks without entering the instrument.  
**CC18** .....\$20.99B

### PICKUP JACK INSTALLATION TOOL

Install acoustic pick-ups in round-hole instruments without removing the strings! Also makes installing through an F-hole a breeze!  
**CC31** .....\$20.99B

PRICES MAY VARY DUE TO EURO/DOLLAR FLUCTUATION

[www.shadow-electronics.de](http://www.shadow-electronics.de)

## MISI PICK UPS

### MAGPIE

The Magpie has some new features: rather than using an output cable that is permanently attached, the unit has a minijack on the treble side that can be connected to either a standard strap-button jack installed in the guitar or a longer cable for temporary installation. The Magpie also includes controls for volume and tone; they're mounted side-by-side on the bottom of the unit and accessible through the soundhole.  
**MSMP** .....\$231.45B



**ACOUSTIC TRIO**  
Simple Jack & power charger with L.R. Baggs acoustic guitar pickup.  
**MSAT** .....\$155.15B

**ACOUSTIC TRIO VT**  
**MSATVT** w/Vol. & Tone Control.....\$202.50B

**VOLUME/TONE CONTROL**  
**MSVTC** .....\$47.25B

**CRYSTAL**  
The Mi-Si Crystal is designed to retrofit existing passive pickup systems to make them active to work with undersaddle pickups.  
**MSCR** .....144.60B

**ACOUSTIC TRIO UKE**  
Simple Jack & power charger with L.R. Baggs ukulele pickup.  
**MSATUKE** .....165.65B

**ALIGN XT**  
Active battery-free preamplifier, L.R. Baggs undersaddle pickup, and Power Charger.  
**MSALXT** .....\$184.10B

### VIOLIN/MANDOLIN



**ACOUSTIC VM**  
Vio/Mando features an active, battery-free preamp designed specifically to work with the Kremona piezo for violin and mandolin.  
**MSATVIO** Violin .....\$207.75B  
**MSATMAN** Mandolin.....207.75B

## EPM PICK-UPS

**AGT100** The Cap, Transducer .....\$38.45  
**AGT100G** The Cap, Transducer, Gospel Theme.....40.35  
**AGT400** Sound Hole, Wood .....70.00



## DRUM TRIGGERS

**DT10** Acoustic Drum Trigger (Yamaha) .....\$51.99

## PEAVEY

### FUNK OUT™

Get the funk and dirt out of high-tech controls, switches and contacts. Deoxidizes, cleans and preserves. Reduces connection failure, wear and abrasion. 5 oz. (200 ml) aerosol spray can.

**00456600** .....\$13.99B

### SILENT SLIDER™

Silent Slider™ is formulated to use on conductive plastic switches, controls, membranes and other sliding plastic surfaces. Lubricates faders, switches, potentiometers and other mechanisms with sliding surfaces.

**00493880** .....\$14.99B

## DEOXIDIZER



**D556** .....\$24.45

## LUBE



Fader, Switch Lubricant  
**F5SH6** .....\$27.15

# DI MARZIO PICK UP GUIDE

## DiMARZIO® HIGH POWER HUMBUCKERS

Pickup Name	Part No.	Output in Millivolts	Tone Guide			DC Resistance	Wiring	Magnet
			Treble	Mid-Range	Bass			
<b>Super Distortion®</b>	DP100	425	5.5	7.5	8	13.68K	4 Conductor	Ceramic
<b>Dual Sound®</b>	DP101	425	5.5	7.5	8	13.68K	4 Conductor	Ceramic
<b>X2N®</b>	DP102	510	6.5	6.5	5.5	15.8K	4 Conductor	Ceramic
<b>Super 2™</b>	DP104	425	8	6	4	8.7K	4 Conductor	Ceramic
<b>Super 3™</b>	DP152	435	5	8	6.5	25.8K	4 Conductor	Ceramic
<b>ToneZone®</b>	DP155	375	5	8.5	8.5	17.31K	4 Conductor	Alnico 5
<b>Evolution® Bridge</b>	DP159	404	6.5	7	6	13.84K	4 Conductor	Ceramic
<b>Steve's Special™</b>	DP161	390	6.5	4.5	7.5	17.89K	4 Conductor	Ceramic
<b>The Breed™ Bridge</b>	DP166	356	5	9	8	17.07K	4 Conductor	Alnico 5
<b>D Sonic™</b>	DP207	390	5.5	6.5	6.5	11.96K	4 Conductor	Ceramic
<b>Evo 2™ Bridge</b>	DP215	375	6	7.5	6	12.81K	4 Conductor	Ceramic
<b>D Activator™ Neck</b>	DP219	385	8	5	4	7.22K	4 Conductor	Ceramic
<b>D Activator™ Bridge</b>	DP220	470	6.5	6	6	11.41K	4 Conductor	Ceramic

## DiMARZIO® MEDIUM POWER HUMBUCKERS

<b>PAF Pro®</b>	DP151	300	6	5	5	8.4K	4 Conductor	Alnico 5
<b>Fred®</b>	DP153	305	5.5	6	5	10.07K	4 Conductor	Alnico 5
<b>Evolution® Neck</b>	DP158	294	6.5	6	6	13.04K	4 Conductor	Ceramic
<b>Nortone®</b>	DP160	352	5	7	6.5	12.58K	4 Conductor	Alnico 5
<b>Breed™ Neck</b>	DP165	325	5	7.5	7.5	10.14K	4 Conductor	Alnico 5
<b>Air Zone®</b>	DP192	323	5	8.5	8.5	17.49K	4 Conductor	Alnico 5
<b>Air Norton®</b>	DP193	270	5	7	6.5	12.58K	4 Conductor	Alnico 5
<b>PAF Joe®</b>	DP213	272	6.5	5	4.5	8.26K	4 Conductor	Alnico 5
<b>Mo' Joe™</b>	DP216	320	5	5.5	5	9.76K	4 Conductor	Alnico 5

## DiMARZIO® VINTAGE OUTPUT HUMBUCKERS

<b>PAF®</b>	DP103	203	6.0	5.5	6.0	8.09K	4 Conductor	Alnico 5
<b>The Humbucker</b>								
<b>From Hell®</b>	DP156	226	8.5	4.5	4.5	5.82K	4 Conductor	Alnico 5
<b>Bluesbucker®</b>	DP163	265	6.0	5.5	4.5	9.85K	4 Conductor	Ceramic
<b>Air Classic™ Neck</b>	DP190	206	5.5	4.5	5.5	8.34K	4 Conductor	Alnico 5
<b>Air Classic™ Bridge</b>	DP191	226	5.5	4.5	6.0	8.62K	4 Conductor	Alnico 5
<b>EJ Custom™ Neck</b>	DP211	178	9.0	4.5	5.0	7.01K	4 Conductor	Alnico 5
<b>EJ Custom™ Bridge</b>	DP212	200	8.5	4.5	5.5	7.85K	4 Conductor	Alnico 5
<b>Virtual Hot PAF™</b>	DP214	265	5.0	6.5	6.5	9.13K	4 Conductor	Alnico 5

## DiMARZIO® HUMBUCKING STRAT®

Pickup Name	Part No.	Output in Millivolts	Tone Guide			DC Resistance	Wiring	Magnet
			Treble	Mid-Range	Bass			
<b>HS-2™</b>	DP116	90	7.5	5.5	5	14.97K	4 Conductor	Alnico 5
<b>HS-3™</b>	DP117	93	6.5	6	6	23.72K	4 Conductor	Alnico 5
<b>Air Norton 5™</b>	DP180	280	4.5	7	6.5	11.21K	4 Conductor	Ceramic
<b>Fast Track 1™</b>	DP181	191	7.5	5	5.5	5.72K	4 Conductor	Ceramic
<b>Fast Track 2™</b>	DP182	321	5	8	7.5	17.53K	4 Conductor	Ceramic
<b>Chopper™</b>	DP184	260	7	6	6	9.19K	4 Conductor	Ceramic
<b>Cruiser® Neck</b>	DP186	140	8	4.5	5	3.13K	4 Conductor	Ceramic
<b>Cruiser® Bridge</b>	DP187	143	8	4.5	5.5	5.75K	4 Conductor	Ceramic
<b>Pro Track™</b>	DP188	275	5.5	6.5	6.5	8.15K	4 Conductor	Ceramic
<b>Tone Zone 5™</b>	DP189	300	5	8.5	8	12.39K	4 Conductor	Ceramic
<b>YJM™</b>	DP217	93	7	6	6	23.5K	4 Conductor	Alnico 5
<b>Super Distortion 5™</b>	DP218	325	5	7.5	8	13.18K	4 Conductor	Ceramic
<b>Virtual Vintage®</b>								
<b>Blues</b>	DP402	145	7.5	5.5	5.5	8.28K	4 Conductor	Alnico 5
<b>Virtual Vintage®</b>								
<b>'54 Pro</b>	DP408	140	8.0	5.5	5.5	7.50K	4 Conductor	Alnico 2
<b>Virtual Vintage®</b>								
<b>Heavy Blues</b>	DP409	170	7.5	6.5	6.0	8.60K	4 Conductor	Alnico 2
<b>Virtual Vintage® 2.2</b>	DP410	124	9.0	4.5	4.0	6.39K	4 Conductor	Alnico 2
<b>Area '58™</b>	DP415	125	9	3.5	3.5	6.12K	4 Conductor	Alnico 2
<b>Area '61™</b>	DP416	142	8.5	4	4	6.47K	4 Conductor	Alnico 2

## Pre-Wired Pickguards and Pickup Sets with Solderless Installation

### PRE-WIRED STRAT REPLACEMENT PICKGUARD

Laminated white - black - white pickguard, white pickups, knobs, solderless installation, specify pickup set:

<b>FG2108WA3</b>	HS™ Setup: HS-4™ / HS-4™ / HS-3™	\$439.00
<b>FG2108WA4</b>	Area™ Setup: Area 58™ / Area 67™ / Area 61™	\$469.99
<b>FG2108WA5</b>	Vintage Setup: True Velvet™ Neck / Middle / Bridge Models	\$379.00
<b>FG2108WA7</b>	High Power Setup: Pro Tracki / Fast Track 1™ / Fast Track 2™	\$455.00
<b>FG2108WA8</b>	BC-1™ / Chopper™ / BC-2™	\$469.99

### PRE-WIRED PICKUP SET FOR TELE

Includes chrome Tele control plate, knobs, chrome and black pickups, complete wiring harness with solderless installation, specify pickup set:

<b>FG2100CA1BK</b>	Vintage Set: Twang King™ Neck / Twang King™ Bridge	\$265.00
<b>FG2100CA2BK</b>	Area™ Set: Area T™ Neck / Area T™ Bridge	\$315.00

### PRE-WIRED PICKUP SET FOR GIBSON LES PAUL WITH LONG SHAFT POTS

Includes black pickups, complete wiring harness with solderless installation, specify pickup set:

<b>GG2101A1BK</b>	Vintage Set: PAF® 36th Anniversary / PAF® 36th Anniversary Bridge	
	F-spaced	\$340.00
<b>GG2101A2BK</b>	Classic Rock Set: PAF® 36th Anniversary / Super Distortion®	
	F-spaced	\$345.00
<b>GG2101A3BK</b>	Modern Metal Set: D Activator™ Neck / D Activator™ Bridge	
	F-spaced	\$330.00

### PRE-WIRED PICKUP SET FOR GIBSON LES PAUL TYPE (Short Shaft Pots)

Includes black pickups, complete wiring harness with solderless installation, specify pickup set:

<b>GG2100A1BK</b>	Vintage Set: PAF® 36th Anniversary / PAF® 36th Anniversary Bridge	
	F-spaced	\$335.00
<b>GG2100A2BK</b>	Classic Rock Set: PAF® 36th Anniversary / Super Distortion®	
	F-spaced	\$340.00
<b>GG2100A3BK</b>	Modern Metal Set: D Activator™ Neck / D Activator™ Bridge	
	F-spaced	\$325.00

### PRE-WIRED P BASS REPLACEMENT PICKGUARD

Laminated white - black - white pickguard, black pickups, knobs, solderless installation, specify pickup:

<b>FB2100WA1BK</b>	DiMarzio Model P®	\$195.00
<b>FB2100WA2BK</b>	Split P™	\$220.00

### PRE-WIRED PICKUP SET FOR J BASS

Includes chrome J Bass control plate, black pickups, knobs, complete wiring harness with solderless installation, specify pickup set:

<b>FB2200CA1BK</b>	DiMarzio Model J™ set	\$270.00
<b>FB2200CA2BK</b>	Area J™ set	\$290.00

Fender®, Strat®, Tele®, Jazz Bass®, and Precision Bass®, are registered trademarks of Fender Musical Instrument Corp., with which DiMarzio, Inc. is not affiliated.

[www.dimarzio.com](http://www.dimarzio.com)

# DI MARZIO PICK UPS

All DiMarzio Humbuckers are available in regular and F-spacing. F-spaced pole pieces are wider, for better string alignment with trem-bridge guitars.  
**All DiMarzio Humbuckers with 12 polepieces are now available with Chrome Tops™ – Add \$75.99 to list price**



## HUMBUCKERS

DP100	Super Distortion®	\$109.99
DP101	Dual Sound®	114.99
DP102F	X2N®	120.99
DP103	PAF®	104.99
DP104	Super 2™	99.99
DP107	MegaDrive™	115.99
DP150	Double Whammy™	109.99
DP151	PAF Pro™	109.99
DP152F	Super 3™	109.99
DP153	FRED®	109.99
DP154	DLX Plus™	104.99
DP155	The Tone Zone™	109.99
DP156	Humbucker From Hell™	99.99
DP157	Multi Bucker (BK)	125.99
DP158	Evolution, neck position	115.99
DP159	Evolution, bridge position	115.99
DP160	Norton (BK, B, Pl, CR, PU)	99.99
DP161	Steves Special, bridge position	99.99
DP162	DLX Plus™ Neck "Soapbar"	104.99
DP163	Bluesbucker	109.99
DP164	Duluxe 90	104.99
DP165	The Breed, neck position	109.99
DP166	The Breed, bridge position	109.99
DP168	Mini Humbucker, Chrome	119.99
DP190	Air Classic, neck position	99.99
DP191	Air Classic, bridge position	99.99
DP192	Air Zone, bridge position	99.99
DP193	Air Norton, neck position	99.99
DP198	Hot Minibucker	119.99
DP200	Steve Morse Model™, bridge	109.99
DP201	Al Di Meola Model™, neck	109.99
DP202	Al Di Meola Model™, bridge	109.99
DP205	Steve Morse Model™, position	109.99
DP207	Drop Sonic	129.99
DP209	P90 Super Distortion	104.99
DP210	Tone Zone P90	104.99
DP211	EJ Custom Neck	109.99
DP212	EJ Custom Bridge	109.99
DP213	PAF Joe	109.99
DP215	Evo. 2, bridge position	115.99
DP216	Mo Joe	109.99
DP219	D Activator, Neck	99.99
DP220	D Activator, Bridge	99.99
DP221	D Activator, X Neck	120.99
DP222	D Activator, X Bridge	120.99
DP223	PAF Bridge	104.99
DP224	Andy Timmons, AT1	109.99
DP224	Andy Timmons, AT1	109.99
DP227	Liquifire	109.99
DP228	Crunch Lab	119.99
DP240	Vintage Minibucker Neck	109.99
DP241	Vintage Minibucker Bridge	109.99
DP244	Dominion™ Neck Model	109.99
DP245	Dominion™ Bridge Model	109.99
DP252	Gravity Storm, Neck Position	115.99
DP253	Gravity Storm, Bridge Position	115.99
DP254	Transition, Neck	115.99
DP255	Transition, Bridge	115.99
DP256	Illuminator, Neck	129.99
DP257	Illuminator, Bridge	129.99
DP258	Titan, Neck	119.99
DP259	Titan, Bridge	\$119.99

## 7 & 8 STRING BRIDGES

DP700	Blaze, neck position, 7 String	119.99
DP701	Blaze, middle position, 7 String	72.99
DP702	Blaze, bridge position, 7 String	119.99
DP703	Blaze, Custom, 7 String	119.99
DP704	Evolution 7, 7 strings	119.99
DP705	X2N, 7 String	129.99
DP706	D Sonic, 7 String	139.99
DP707	Liquifire, 7 String	119.99
DP708	Crunch Lab, 7 String	130.99
DP709	Ionizer 7 String, Neck	129.99
DP711	Ionizer 7 String, Bridge	129.99
DP712	Super Distortion 7 String	119.99
DP719	D Activator 7, Neck	119.99
DP720	D Activator 7, Bridge	119.99
DP793	Air Norton, 7 String	119.99
DP755	Tone Zone 7 String	119.99
DP756	Illuminator 7 String, Neck	139.99
DP757	Illuminator 7 String, Bridge	139.99
DP759	PAF® 7-String	119.99
DP809	Ionizer 8 String, Neck	139.99
DP810	Ionizer 8 String, Middle	79.99
DP811	Ionizer 8 String, Bridge	139.99
DP812	Super Distortion 8 String	129.99
DP819	D Activator Neck 8 String	129.99
DP820	D Activator Bridge 8 String	129.99
DP859	PAF® 8-String	129.99

## SINGLE COIL

DP110	FS-1™	\$69.99
DP111	SDS-1™	69.99
DP115	HS-1™	94.99
DP116	HS-2™	99.99
DP117	HS-3™	99.99
DP167S	Soapbar, P90	104.99
DP167D	Soapbar, Dog Ear	105.99
DP169	Virtual Pro	109.99
DP174	Red Velvet	79.99
DP175	True Velvet Neck	79.99
DP175S	True Velvet Middle	79.99
DP176	True Velvet Bridge	79.99
DP180	Air Norton	109.99
DP181	Fast Track 1™	109.99
DP182	Fast Track 2™	109.99
DP184	The Chopper, Bridge Pick UP (BK, BL)	109.99
DP186	Cruiser, Neck	109.99
DP187	Cruiser	109.99
DP188	ProTrack	109.99
DP189	Tone Zone S	109.99
DP217	HS4	99.99
DP218	Super Distortion	109.99
DP225	Billy Corgan, Neck	109.99
DP226	Billy Corgan, Bridge	109.99
DP402	Virtual Vintage Blues	105.99
DP408	Virtual 54 Pro	105.99
DP409	Virtual Heavy Blues 2	105.99
DP415	Area 58	109.99
DP416	Area 61	109.99
DP419	Area 67	109.99
DP420	Virtual Solo	105.99
DP422	Injector Neck	109.99
DP423	Injector Bridge	109.99
DP425	Satch Track, Neck	119.99

## TELES

DP112	Pre B-1™	\$79.99
DP172C	Twang King, neck position, chrome	84.99
DP173	Twang King, bridge position	\$84.99
DP177N	True Velvet T Neck	79.99
DP178	True Velvet T Bridge	79.99
DP318	Super Distortion T	109.99
DP380	Air Norton T	105.99
DP381	Fast Track T™	109.99
DP384	Chopper T	109.99
DP389	Tone Zone T	109.99
DP417	Area T Neck	109.99
DP417C	Area T, Neck, Chrome	109.99
DP418	Area T, Bridge	109.99
DP421	Area Hot T	109.99
DP424	Area T 615™	109.99

## ACOUSTIC GUITARS

DP130BK	Acoustic Model™ (BK)	\$70.99
DP134BK	The Elemental, 12 Adjustable Pole Pieces, (BK)	109.99
DP136	DP135 with volume control	109.99
DP138BK	Virtual Acoustic	109.99
DP230	The Angel	199.99
DP231	The Angel Active	249.99
DP232	The Angel System	379.99
DP233	The Angel™ PZ Standalone Undersaddle Pickup System	189.99

## BASSES

DP120	Model One™	\$130.99
DP122	DiMarzio Model P®	94.99
DP123	DiMarzio Model J™	160.99
DP125	X2N-B™	120.99
DP126	DiMarzio Model P + J™	159.99
DP127	Split P	119.99
DP145	Will Power, Neck	135.99
DP146	Will Power, Middle	105.99
DP147	Ultra Jazz, Neck	85.99
DP148	Ultra Jazz, Bridge	85.99
DP149	Ultra Jazz, Set	160.99
DP247	Area J Neck	95.99
DP248	Area J Bridge	95.99
DP249	Area J Set	180.99
DP250	Area P™	99.99
DP251	Area P+J™	180.99
DP547	Ultra Jazz 5, Neck, 5 String	99.99
DP548	Ultra Jazz 5, Bridge, 5 String	99.99
DP550	Area J 5 Neck	109.99
DP551	Area J 5 Bridge	109.99
DP552	Area J 5 Set	199.99

## AVAILABLE COLORS:

*BB	black & blue	*BY	black & yellow
*BG	black & green	*PI	pink
*BW	black & white	*W	white
*G	green	*BK	black
*R	red	*BP	black & pink
*BC	black & creme	*CR	creme
*BL	blue	*RB	red & black
		*Y	yellow

\*Add \$10.99 to List Price

# FISHMAN

## POWER JACK



The POWERJACK endpin preamp is compatible with virtually any brand of passive piezo under-saddle pickup or soundboard transducer, and will dramatically improve the existing pickup's performance.

- FTPJ Power Jack Preamp.....\$156.05B
- FT9PJ 9 Pin Switch Jack .....27.45B

### ACCESSORIES

- BASS
- FTCLIP 1 Pair felted u-clips .....\$27.45B
- BLEBAJ Stereo jack, Endpin.....27.45B

## POWERBRIDGE PICKUPS



- FTVTC Chrome Vint Tele.....\$346.85B
- FTASTC Chrome AM Std. Tele .....346.85B
- FTCVSC Chrome Wilk Strat .....485.60B

www.fishman.com

## AURA ACOUSTIC IMAGING PEDALS



- FTSPC Aura Spectrum DI .....\$572.35B
- FTP16 Aura Sixteen .....433.60B
- FTJD1 Jerry Douglas Aura.....502.95B
- FTP0W Aura AC Adapter .....16.85B

# PICK-UPS



DMS3000



DMS3015

## DEAN MARKLEY

- DMS3000 Artist™ Pickup Transducer .....\$54.99
- DMS3001 Artist™ Pickup XM (24" Cable + Clip) Transducer.....54.99
- DMS3030 Artist Kit™ Pickup (End Pin Model) Transducer .....54.99
- DMS301 ProMag™ Plus (Standard) .....71.99
- DMS3011 ProMag™ Plus XM (24" Cable + Clip).....71.99
- DMS3015 ProMag™ Grand (Humbucker-style) .....89.99
- DMS3016 ProMag™ Grand XM (24" Cable + Clip) .....89.99
- DMS3018 ProMag™ Grand Gold (Humbucker-style) .....99.99

www.deanmarkley.com

## BELCAT PICKUPS

- SH80 Humbucking Sound Hole P/U ....\$39.99
  - SH85 Single Coil Sound Hole P/U .....34.99
  - EGT300 Clip on Transducer for all Acoustic Instruments.....19.98
- Mounts to any instrument that vibrates.
- AIT1 .....\$21.15

## TUNING MIC PICKUP

- WCP60G Guitar Pick Up .....\$11.95
  - WCP60V Violin Pick Up .....11.95
- Clips into the soundhole of any steel or nylon steel guitar. Felt backed to prevent marring your finish and can be installed in seconds without any tools, with volume control.
- GSP1 .....\$25.90

## INTERNAL SOUNDHOLE MIC



- GHSA137 .....\$103.95

# SCHALLER PICK-UPS/TRANSDUCERS



## WESTERN SERIES, MOUNTS IN SOUNDHOLE PICK UPS

- HS1043 (16060203) Round hole pick up .....\$74.10
- HS1070 (16070000) Bass violin pick up. Mounts on fingerboard .....174.75



## TRANSDUCERS

- HS1082 (16050201) Guitar. Internal mount, with jack .....\$46.00
- HS1083 (16050202) Guitar. Dual transducers to create enhanced bass and treble. Internal mount, with jack.....73.55
- HS1084 (16050203) Guitar. Chrome plated transducer with 9 ft. cord and metal plug .....69.15



# FISHMAN

## SOUNDHOLE PICKUPS



FT101



FT102

<b>FT101</b>	Rare Earth Single Coil Sound Hole P/U .....	<b>\$208.10B</b>
<b>FT102</b>	Rare Earth Humbucker Sound Hole P/U .....	<b>277.45B</b>
<b>FT103</b>	Rare Earth Humbucker Blender, with Mic.....	<b>537.65B</b>
<b>FTNEOD01</b>	Neodymium Acoustic Guitar .....	<b>86.65B</b>
<b>FTNEOD02</b>	Neodymium Acoustic Guitar, Humbucker.....	<b>156.05B</b>

## UNDERSADDLE PICKUPS



<b>FTMIW</b>	Matrix Infinity Wide .....	<b>\$260.10B</b>
<b>FTMIN</b>	Matrix Infinity Narrow .....	<b>260.10B</b>
<b>FTAG094</b>	3/32 Bridge Pick Up, 2.125 Spacing.....	<b>156.05B</b>
<b>FTAGX94</b>	3/32 Bridge Pick Up, 2.3125 Spacing .....	<b>156.05B</b>
<b>FTAG125</b>	Acoustic Guitar Transducer.....	<b>156.05B</b>
<b>FTAGX312</b>	12 String.....	<b>156.05B</b>

## ELLIPSE PICKUP SYSTEMS



FTMANELA



FTMATAP7

<b>FTSPC</b>	Aura, Spectrum DI.....	<b>\$572.35B</b>
<b>FTMANELA</b>	Aura, Narrow .....	<b>537.65B</b>
<b>FTMATELA</b>	Aura, Wide .....	<b>537.65B</b>
<b>FTMATEL2</b>	Matrix Blend 1/8" width Undersaddle P/U .....	<b>416.25B</b>
<b>FTMANEL2</b>	Matrix Blend 3/32" width Undersaddle P/U .....	<b>416.25B</b>
<b>PREFIX PREMIUM BLENDER</b>		
<b>FTMATAP7</b>	Wide, 3.2mm.....	<b>\$711.10B</b>

## STRING SOLUTIONS



<b>FTSBTE</b>	Pick-up Acoustic - w/End Pin Jack .....	<b>\$156.05B</b>
<b>FTSBTH</b>	Pick-up Concert Harp-Piano .....	<b>156.05B</b>
<b>FTSBTC</b>	Pick-up Classical GTR.....	<b>156.05B</b>
<b>FTATGT</b>	Arch Top Guitar .....	<b>346.85B</b>

## VIOLIN/CELLO/BASS



FTV100



FTV200

<b>FTV100</b>	Violin Pick Up .....	<b>\$190.75B</b>
<b>FTV200</b>	Violin Pick Up, Side Mount.....	<b>277.45B</b>
<b>FTC100</b>	Cello Pick Up .....	<b>242.75B</b>
<b>FTBP100</b>	Bass Pickup .....	<b>277.45B</b>
<b>FTFCL</b>	Bass Full Circle.....	<b>398.90B</b>
<b>FTV300VI</b>	Concert Series Violin .....	<b>329.50B</b>
<b>FTV400VI</b>	Concert Series Viola .....	<b>378.40B</b>
<b>FTC200CE</b>	Concert Series Cello.....	<b>364.20B</b>

## MANDOLIN/BANJO/RESOPHONIC



FTM200

<b>FTM100</b>	Mandolin Pick-up .....	<b>\$242.75B</b>
<b>FTM200</b>	Mandolin Pick-up .....	<b>312.15B</b>
<b>FTBAN</b>	Banjo Pick Up Rare Earth.....	<b>312.15B</b>
<b>FTRES001</b>	Passive Resophonic .....	<b>208.10B</b>
<b>FTRES002</b>	Active Resophonic.....	<b>242.75B</b>
<b>FTRESSPI</b>	Resophonic, Spider Style .....	<b>329.50B</b>
<b>FTM300MA</b>	Mandolin, Arch Top, Nashville.....	<b>364.20B</b>
<b>FTM400MA</b>	Mandolin, Flat Top, Nashville .....	<b>364.20B</b>

## PREAMPS



<b>FTGE2</b>	Acoustic Guitar PreAmp .....	<b>\$104.00B</b>
<b>FTBA2</b>	Acoustic Bass PreAmp.....	<b>104.00B</b>
<b>FTVTP</b>	Vol, Treble, Bass .....	<b>137.45B</b>
<b>FTPC</b>	Power Chip Preamp .....	<b>156.05B</b>
<b>FTEQ2</b>	Acoustic Instrument PreAmp/EQ .....	<b>190.75B</b>
<b>FTPLT101</b>	Platinum Acoustic Instr. PreAmp/EQ/DI .....	<b>260.10B</b>
<b>FTPLTBAS</b>	Platinum Bass EQ/DI .....	<b>260.10B</b>

### Presys+ System

The compact sophisticated Presys+ system features Volume, Bass, Mid and Treble controls, a Phase switch, and a built-in tuner with LED display. The Presys+ preamp also includes a pre-wired Fishman Sonicore pickup for solder-free, plug and play installation.

<b>FTPPS</b>	.....	<b>\$312.15B</b>
--------------	-------	------------------

### Triple Play Wireless Guitar Controller

TriplePlay is the composing, performing and recording system that puts an unlimited palette of instruments and sounds at your fingertips - all with the freedom of wireless control. TriplePlay can be installed or removed quickly, on virtually any electric guitar, with no permanent installation necessary. Mounting hardware included.

<b>FTTRP301</b>	.....	<b>\$630.70B</b>
-----------------	-------	------------------

## FENDER PICKUPS



### Stratocaster Pickups

<b>2113000</b>	Fat '50's Strat – Set of 3 .....	<b>\$286.90</b>
<b>2112000</b>	Custom '54 Strat – Set of 3 .....	<b>286.90</b>
<b>2114000</b>	Custom '69 Strat – Set of 3 .....	<b>286.90</b>
<b>2111000</b>	Texas Special Strat – Set of 3 .....	<b>286.90</b>
<b>2105000</b>	Hot Noiseless Strat – Set of 3 .....	<b>286.90</b>
<b>2115000</b>	Vintage 'Noiseless' Strat – Set of (3) .....	<b>286.90</b>
<b>2115006</b>	Vintage 'Noiseless' Strat – Black Set of 3 .....	<b>229.50</b>
<b>2117000</b>	'57/'62 Strat – Set of 3.....	<b>229.50</b>
<b>2131000</b>	Tex Mex Strat – Set of 3 .....	<b>149.20</b>

### Telecaster Pickups

<b>2121000</b>	Texas Tele – Bridge/Neck .....	<b>\$229.50</b>
<b>2109000</b>	51 "No-Caster" – Set of 2 .....	<b>229.50</b>
<b>2116000</b>	'Noiseless' Tele – Set of 2 .....	<b>229.50</b>
<b>2119000</b>	Original Tele – Set of 2.....	<b>172.15</b>

### Precision Bass Pickups

<b>2046000</b>	Original P-Bass Pickup .....	<b>\$126.25</b>
----------------	------------------------------	-----------------

### Jazz Bass Pickups

<b>2101000</b>	Custom 60's J-Bass Set of 2.....	<b>\$229.50</b>
<b>2123000</b>	Original J-Bass Set of 2 .....	<b>172.15</b>
<b>2102000</b>	'Noiseless' J-Bass Set of 2 .....	<b>229.50</b>

### Humbuckers

<b>2136000</b>	EVH Frankenstein.....	<b>\$270.00</b>
----------------	-----------------------	-----------------

## WD PICKUPS



<b>M213</b>	Black Humbucker.....	<b>\$39.95</b>
<b>M214</b>	Black Distortion Humbucker.....	<b>39.95</b>
<b>WPU12</b>	Black, Single Coil .....	<b>39.95</b>



<b>TL4R</b>	Tele Lead .....	<b>\$58.25</b>
<b>TL4F</b>	Tele Rhythm .....	<b>57.15</b>
<b>THR1R</b>	Tele Hot Rail.....	<b>78.40</b>
<b>SLHC1</b>	Chrome Lipstick .....	<b>78.40</b>
<b>SLV1</b>	Chrome Lipstick Vintage .....	<b>84.00</b>



<b>WPU90BL</b>	Black Soapbar Single Coil .....	<b>\$76.20</b>
<b>WPULJ</b>	Black Dog Ear Single Coil .....	<b>83.25</b>
<b>WPU900C</b>	Humbucker.....	<b>78.45</b>
<b>HR1R</b>	Single Coil Rails .....	<b>70.00</b>

## SRO BY EMG



**SROOC1B/SR00C1N**.....**\$99.99**  
Traditional open coil design with the perfect balance between clarity and high gain, the SRO OC1 is perfect for rock, blues, metal or country. *Package includes: EMG's exclusive Quik-Connect.™ Options available: Neck and Bridge positions. Black only.*

**SROSCIB/M/N** .....

**\$79.99**  
The SC1 single coils feature a combination of warm, clear tone with the traditional percussive attack of pole-pieces. *Package includes: EMG's exclusive Quik-Connect.™ Options available: Specify neck, middle or bridge position. Black only.*

**SROSC1SET** .....

**\$199.99**  
The new SRO SC1 Set is designed in the vintage Strat style, with crisp high end and warm mid-range. With Alnico V Bar magnets, each SC1 is designed specifically for neck, middle, and bridge positions. *Package includes: EMG's exclusive Quik-Connect.™ Options available: Black only.*

**ALX** .....

**\$139.99B**  
The ALX with ABQ EQ/Boost – the new Alexi Laiho signature model – is a newly designed EMG HZ passive model that includes the new ABQ EQ/Boost that features a push (to activate) / pull (to deactivate) control. *Package includes: ALX + ABQ EQ/Boost, EMG's exclusive 5-wire Quik-Connect.™*

**FALX**.....

**139.99B**  
Same as above with F spacing.

**ACS** .....

**\$179.99**  
The ACS employs a unique internal preamp that's been tailored for the phase and frequency response of an acoustic guitar while still retaining a brilliant top-end favored in acoustic guitar tone. *Package includes: Quik-Connect™ cable, End Pin Jack with cable, cable keepers, battery bag, allen wrenches (.062 & .093 inches), velcro dot, and instructions.*

**JHZ** .....

**\$159.99**  
With sweeping harmonic overtones and clarity, the JHZ pickup has characteristic jazz bass tone, but due to our custom design adds a modern broad tonal response. *Package includes: Mounting screws. Options Available: Only available in black.*

**PHZ**.....

**\$109.99**  
The passive version of our original P design, the PHZ covers a wide sonic palette of classic and modern bass sounds. Because the PHZ utilizes ceramic magnets coupled with short, squat coils, the tone has a lot of high-end articulation, warmth, and incredible low end punch. *Package includes: Mounting screws. Options Available: Only available in black.*

**PIHZ** .....

**\$159.99**  
The PIHZ SET combines a P pickup with an LJ pickup into on set, giving you more flexibility and a great passive tone. *Package includes: Mounting screws. Options Available: Only available in black.*

**AB** .....

**\$59.99\***  
The AB (Afterburner) is a push/pull booster with up to 20dB of preset variable gain, perfect for having fun with clean overdrive and distortion. *Package includes: Output jack and battery clip set.*

**PA2** .....

**\$59.99**  
The PA2 is a straight booster preamplifier mounted on a minitoggle switch. *Package includes: Output jack and battery clip set.*

**EXG** .....

**\$59.99\***  
The frequency response of the EXG is similar to normal guitar amp equalization. The lows and highs are boosted while the midrange is dipped out. *Package includes: Output jack and battery clip set.*

**EMGJVSET** .....

**\$209.99**  
JV Set, Single Coil, 4-string vintage jazz bass retrofit.

**SPC** .....

**\$59.99\***  
The SPC or "Strat Presence Control" is often called the fat control. The original intent of the SPC was to turn the tone of a single-coil pickup into a dual-coil. *Package includes: Output jack and battery clip set.*

## EMG HZ PICKUPS



### PASSIVE

#### GUITAR DUAL-COIL

Tune-a-matic Pole Spread

<b>EMGHIB/N</b>	Bridge/Neck, Distortion Bright High Output.....	<b>\$109.99</b>
<b>EMGHIAB/N</b>	Bridge/Neck, High Output Blues Humbucker.....	<b>109.99</b>
<b>EMGH2B/N</b>	Bridge/Neck, Ceramic loaded Hot-Rodded PAF.....	<b>109.99</b>
<b>EMGH2AB/N</b>	Bridge/Neck, Vintage; EMG's own PAF Bluesy and Pure	<b>109.99</b>
<b>EMGH3</b>	(Hidden Studs), Clean for Rhythm; "The Passive EMG-60" .....	<b>109.99</b>
<b>EMGH3A</b>	(Hidden Studs), Bright and fat for Bridge; "Passive EMG-60A" .....	<b>109.99</b>
<b>EMGH4</b>	(Rails), High Output Model "The Passive 81".....	<b>109.99</b>
<b>EMGH4A</b>	(Rails), High Output Round Rocker, great for bridge slide.....	<b>109.99</b>
<b>EMGHZ7</b>	(Rails), Ceramic for crisp low end in 35HZ Housing .....	<b>109.99</b>



#### GUITAR DUAL-COIL

Floyd Rose Pole Spread

<b>EMGFH1</b>	Distortion Bright High Output .....	<b>\$109.99</b>
<b>EMGFH1A</b>	High Output Blues Humbucker .....	<b>109.99</b>
<b>EMGFH2</b>	Ceramic Hot-Rodded PAF .....	<b>109.99</b>
<b>EMGFH2A</b>	Vintage Bluesy and Pure Lead Pickup.....	<b>109.99</b>
<b>EMGFH3</b>	Clean for Rhythm.....	<b>109.99</b>
<b>EMGFH3A</b>	Bright and Fat .....	<b>109.99</b>



#### P-90 MODELS

<b>EMGP91</b>	(Humbucking), High Output edge distortion (Neck).....	<b>\$109.99</b>
<b>EMGP92</b>	(Humbucking), The Blues Rocker (Bridge) .....	<b>109.99</b>



#### SINGLE COIL

<b>EMGS1</b>	(Flat Poles), High Output Overwound Stack .....	<b>\$79.99</b>
<b>EMGS2</b>	(Flat Poles), Vintage Tone Stack.....	<b>79.99</b>
<b>EMGS3</b>	(Hidden Poles), Same as S1 but Hidden Poles .....	<b>79.99</b>
<b>EMGS4</b>	Rails, Heavy Duty High Output Rock'n'Roll .....	<b>79.99</b>



#### ELECTRIC BASS

<b>EMG35HZ</b>	4 String, Warm bright/Splittable 2.7 .....	<b>\$109.99</b>
<b>EMGJHZSET</b>	4 String, Our design utilizes stacked ceramic loaded coils, which increases low frequency response, increases output, and lowers noise. JHZ pickup has characteristic jazz bass tone.	<b>159.99</b>
<b>EMG40HZ</b>	5 String, Warm bright/Splittable 3.2.....	<b>109.99</b>
<b>EMG45HZ</b>	6 String, Warm bright/Splittable 3.6 .....	<b>109.99</b>



### ACTIVE

#### HUMBUCKING

<b>EMG60</b>	Bright medium output, great rhythm pickup .....	<b>\$129.99</b>
<b>EMG81</b>	Classic bridge pickup .....	<b>129.99</b>
<b>EMG85</b>	Classic neck pickup .....	<b>129.99</b>
<b>EMGJHSET</b>	The EMG custom black nickel James Hetfield signature set neck and bridge. ....	<b>299.99B</b>
<b>EMGZWSSET</b>	EMG 81 + EMG 85 Set .....	<b>259.99</b>
<b>EMGKFKSET</b>	EMG 81 + EMG 85 Set w/ EMG PA2 booster .....	<b>269.00</b>
<b>EMG60A</b>	Dual coil, warm, medium output .....	<b>129.99</b>
<b>EMG607</b>	Dual coil, bright, medium output 7-string in 35 soapbar housing .....	<b>134.99</b>
<b>EMG89R</b>	Dual coil, switches between 85 & SA (for neck).....	<b>149.99</b>
<b>EMG707</b>	7-string classic metal hot lead.....	<b>134.99</b>
<b>EMG808</b>	7-string humbucker, distortion & clean.....	<b>134.99</b>
<b>EMG808</b>	8-string humbucker, distortion & clean.....	<b>139.99</b>
<b>Single Coil</b>	Single coil with Alnico bar magnet .....	<b>\$99.99</b>
<b>EMGSA</b>	Single coil warm Tele set.....	<b>209.99</b>
<b>EMGTSET</b>	Complete 3 pickup set with everything needed to install .....	<b>259.99</b>



#### BASS REPLACEMENTS

<b>EMGPJSET</b>	4-string P+J combination set.....	<b>\$209.99</b>
<b>EMGPPSET</b>	4-string precision bass retrofit .....	<b>129.99</b>
<b>EMGJSET</b>	4-string jazz band retrofit .....	<b>209.99</b>
<b>EMGJVSET</b>	Single coil, 4-string vintage jazz retrofit .....	<b>209.99</b>
<b>EMGJ5SET</b>	Single coil, 5-string jazz set with low frequency response, tight mid-range punch, dynamic high end response.....	<b>249.99</b>



#### EXTENDED SERIES BASS

<b>EMG35DC</b>	4-string soapbar, 2.75" maximum string width .....	<b>\$129.99</b>
<b>EMG40DC</b>	5-string soapbar, 3.25" maximum string width .....	<b>129.99</b>
<b>EMG45DC</b>	6-string soapbar, 3.75" maximum string width .....	<b>129.99</b>
<b>EMG35CS</b>	Full dual coil ceramic/steel, 4-string soapbar, 2.75" maximum string width .....	<b>129.99</b>
<b>EMG40CS</b>	Full dual coil ceramic/steel, 5-string soapbar, 3.25" maximum string width .....	<b>129.99</b>
<b>EMG45CS</b>	Full dual coil ceramic/steel, 6-string soapbar, 3.75" maximum string width .....	<b>129.99</b>



#### PREWIRED PICKGUARD

<b>EMGDG20</b>	Custom Strat pickguard system (SA Set/SPC/EXG Circuits) .....	<b>\$389.99B</b>
<b>EMGKH20</b>	Custom Strat pickguard system (S/S/81) .....	<b>\$329.99B</b>

Call for Dealer Pricing. Other models available for Special Order  
[www.emgpickups.com](http://www.emgpickups.com)

## SELECT PICKUPS



SELECT PICKUPS are designed for performance and incorporate the most recent impedance technological advancements. All pickups have been specially sealed to reduce microphonics. Each model has been carefully designed for specific properties by E.M.G. president, Rob Turner. Passive Design.

<b>SES</b>	Strat .....	<b>\$50.00B</b>	<b>SEP</b>	Precision .....	<b>\$60.00B</b>
<b>SEHG</b>	Humbucker Guitar.....	<b>60.00B</b>	<b>SEPJ</b>	P-J Set.....	<b>120.00B</b>
<b>SEJ</b>	Jazz Bass Set.....	<b>119.00B</b>	<b>SEHB</b>	Humbucker Bass .....	<b>60.00B</b>

# LR BAGGS

## GUITAR



Saddle pick up for acoustic guitar.  
**LB6** Steel String.....**\$129.00B**  
**LBC** Classical.....**129.00B**

## UKULELE



Undersaddle pickup with miniature endpin preamp and soundhole mounted volume control.  
**FIVEO** Five.O Ukulele.....**\$209.00B**

## FEEDBACK MASTER



Active feedback eliminator, beltclip, mic-stand adapter.  
**FBMS** Chrome .....**\$139.00B**

## ANTHEM



Tru Mic System w/Element P/U. With Soundhole Pre Amp.  
**ANTHEM** .....**\$429.00B**  
 Tru-Mic, Element P/U and side mounted preamp with tuner.  
**STPANTHEM** Chrome.....**\$429.00B**  
 Internal Tru-Mic system w/Element P/U and endpin preamp.  
**ANTHEMSLC** Classical .....**\$289.00B**  
 With Endpin Pre Amp & VC  
**ANTHEMSL** .....**\$289.00B**

## M80



Active/passive Switch and Volume Control.  
**M80** .....**\$359.00B**  
**M1C2** Pre-Wired Harness .....**35.00B**

## M1



Soundhole Magnetic Pickup.  
**LRBM1** .....**\$199.00B**  
**LRBM1A** Active.....**249.00B**  
**M1C2** Pre-Wired Harness.....**35.00B**

## X BRIDGE



Add great acoustic sound to your trusty Strat with our easy to install bridge replacement pickup. Replaces 6 hole Vintage bridge.  
**XBVIC** Chrome .....**\$169.00B**  
**XBUSC** Chrome, 2 Hole.....**169.00B**  
**XBUSGO** Gold.....**179.00B**

## IMIX



IBeam & Element Pickups with Internal Mixing PreAmp  
**IMIX** .....**\$329.00B**  
 Internal preamp/mixer with Element and IBeam pickups and Remote Control II.  
**IMIXC** Classical .....**\$329.00B**

## LYRIC MICROPHONE SYSTEM



Acoustic guitar mic w/pre-amp and volume control.  
**LYRIC** .....**\$289.00B**  
**LYRICC** Classical.....**289.00B**

## DUAL SOURCE SYSTEM



Class A mixer that seamlessly blends the ribbon transducer and a FET condenser microphone. It mounts unobtrusively inside the instrument.  
**DSELE** .....**\$299.00B**

## RADIUS



**RADIUSM** Mandolin .....**\$189.00B**  
**RADIUSV** Violin .....**189.00B**

## GIG PRO



Belt clip PreAmp Fingertip control of your sound.  
**GIGPRO** .....**\$139.00BB**

## IBEAM



Bridge Plate Transducer  
**IBEAM** .....**\$129.00B**  
**IBEAMC** Classical.....**129.00B**  
**IBAS** Active .....**199.00B**  
**IBPRE** Pre Amp .....**89.00B**  
 Endpin preamp and soundhole volume control.  
**IBASC** Classical .....**199.00B**

## VIOLIN PICKUP



Features a miniature directional vibration sensor, cast into the bridge itself.  
**VIOL01** .....**\$199.00B**

## PARA ACOUSTIC DI VENUE DI



Class A FET input stage, a phantom powerable XLR, a 5-band EQ with two tunable bands and phase reversal.  
**PARA01** .....**\$249.00B**  
 Full isolation DI/floor box  
**VDI** .....**\$399.00B**

## ELEMENT ACTIVE



Element Pick Up, Pre Amp, Volume control, and Strap Jack  
**EAS** .....**\$189.00B**  
**EASC** Classical .....**189.00B**  
**EASVTC** EAS w/V&T .....**209.00B**  
**EASVTCN** EASC w/V&T .....**209.00B**  
 Element pickup and side mounted preamp with tuner.  
**STPELE** Stage Pro .....**\$259.00B**

# EMG

## Active Electronics for Guitar and Bass



- BTCCON** Bass/treble control on concentric pot, replaces 1 pot .....**\$99.99B**
- BTCSYS** System: separate blend, volume controls, concentric bass/treble Controls, replaces 3 pots.....**109.99B**
- BTSCON** Bass/treble on separate pots, replaces 2 pots.....**99.99B**
- BTSSYS** System: bass, treble, blend & master volume on separate pots, replaces 4 pots .....**109.99B**

- BQCCON** Control: concentric bass/treble, concentric mid, replaces 2 pots.....**\$139.99B**
- BQCSYS** System: concentric bass/treble, concentric mid blend, master volume, replaces 4 pots .....**169.99B**
- BQSCON** Control: concentric bass/treble, mid & eq, replaces 3 pots..**139.99B**
- BQSSYS** System: bass, treble, concentric mid/eq blend, master volume, replaces 5 pots .....**169.99B**

## PEDAL JUICE

Power Multiple Effects Pedals – all at the same time 9V Lithium-Ion battery featuring SANYO eneloop technology. Up to 50 hours of continuous, quiet, clean, stable power from the first note to the last. Eliminates AC ground loops so your tone comes through loud and clear. Two 9V DC outputs power multiple devices: pedals, multi-effect units, and portable recorders. 3-stage LED indicator provides power level status. Single on/off button – no need to unplug pedals. Rechargeable hundreds of times – saves money and the environment. Water and shock resistant – JIS IPX3 compliant water resistant enclosure. Fully recharges in only 3.5 hours via AC adaptor (included). Same footprint as standard effects pedal (2.5"W x 4.7"D x 1.7"H).



- KBC9V3U** White .....**\$199.99B**
- KBC9V3UBK** Black .....**199.99B**

## ONE SPOT



- C35** 3.5mm Convert .....**\$4.40**
- CYR** Polarity Convert .....**4.40**
- CBAT** Batt Clip Convert .....**4.40**
- CL6** Line 6.....**4.40**

**COMBO PACK**  
1 SPOT Power Adapter. Multi-Plug 8 Cable. (2) Battery Clip Converters, (2) 3.5mm (1/8") Converters and an L6 Converter. Handles up to 1700ma. Extra-long 10' cable.

- NW** Powers up to 12 effects .....**\$24.95B**
- NWMC** Multi Cable (5).....**9.95\***
- MC8** Multi Cable (8) .....**14.95B**

- NWICP2** .....**\$39.95B**

## DC BRICK



Power up to TEN pedals or stomp boxes at once... even mixing 9V and 18V... but that's just the beginning. It's ready made for world touring, because it'll accept nearly ANY incoming AC power – from 100 to 240 volts, at 47 to 63 hz, with cables.  
**MXRM237** .....**\$171.42B**

## MULTI SUPPLY



Powers up to 5 effects. Pedals includes: 5 DC Cables  
**PCS20A** Multi Cable, 8.....**\$24.50B**  
**PDC373** Multi Cable, 4 .....**13.70**

## MARTIN THIN LINE PICK-UPS



- T332** Martin .....**\$120.00B**
- 24CTAJ** Martin, 332 Plus with active end pin .....**150.00B**
- 24CTGP2** Thin Line, Gold Plus .....**185.00B**

## ADAPTORS



- High quality AC adaptors.  
**YPA130** Yamaha, 12V, 1A.....**\$20.00B**  
**YPA150** Yamaha, 12V, 1.5A ....**40.00**

Designed to operate all Boss compact and rocker units on A.C.  
**PSA120** .....**\$31.50B**

- MAXON**  
**GPA9S** Single PSU.....**\$25.00**  
**GPA9B** Basic Kit .....**37.50B**  
**GPA9D** Deluxe Kit .....**45.00B**

- SNARK**  
**SA1** 9 Volt Power .....**\$19.95**  
**SA2** Multicable.....**9.95**



- CA1M** Multi (3, 4.5, 7.5, 9, 12) volts – 500 ma.....**\$20.75**
- ACD477** Multi with 6 Tips .....**19.85**

## BATTERIES

### EVEREADY

EN91	Alkaline	AA	4 Pak	<b>\$3.70B</b>
EN92	Alkaline	AAA	4 Pak	<b>3.89B</b>
9V	Alkaline	9V	1 Pak	<b>4.10</b>

### ROCKET/DANELECTRO

6F22M	Carbon Zinc	9V	10 Pak	<b>\$21.50</b>
DB2	Carbon Zinc	9V	2 Pak	<b>3.99B</b>

### VARTA

1P4922	Alkaline	9V	1 Pak	<b>\$3.15B</b>
2P4914	Alkaline	C	2 Pak	<b>3.85B</b>
2P4920	Alkaline	D	2 Pak	<b>3.85B</b>
4P4903	Alkaline	AAA	4 Pak	<b>3.15B</b>
4P4906	Alkaline	AA	4 Pak	<b>3.15B</b>
DL6032	Lithium	3V	1 Pack	<b>2.50</b>

### BATT-O-METER

Checks battery life of active instruments & effects pedals. Reads battery life and time remaining.

**BOM** .....**\$37.75**



## PEAVEY® BATTERY DISPLAY



00497010	AA Batteries, 4 pack.....	<b>\$3.59B</b>
00050130	Battery, 9V, single pack.....	<b>3.59B</b>
00578740	Battery Display*	

\*Available with qualifying orders. Contact your sales rep for details.

## MORLEY



### CLASSIC WAH

Electro-Optical wah (no pots to wear out) with Classic wah tones of the 70's and 80's.

**CLW** .....**\$144.00**

### MINI WAH

**MMW** 4.5" x 6.75" x 2.75" .....**164.00**



### BAD HORSIE WAH

Steve Vai and Morley joined forces to create the worlds best selling switchless wah. Steve's precise wah tone plus no pots to wear out!

**VAII** .....**\$242.00**



### BAD HORSIE 2 CONTOUR WAH

Two footswitchable wah modes; Bad Horsie and Countour Wah. In contour mode, two knobs allow adjustment of wah level and tone.

**VAI2** .....**\$276.00**



### MARK TREMONTI WAH

Switchless wah with wider frequency range plus a boost knob that adds up to 20dB of wah boost.

**MARK1** .....**\$264.00**



### POWER WAH

Electro-Optical control meets vintage wah tone of the late 60's. Level control for wah. LED Indication.

**PWO** .....**\$178.00**

### GEORGE LYNCH WAH

**GLD2** Dragon 2 .....**\$308.00**



### POWER WAH VOLUME

Vintage wah and smooth optical volume control in a single pedal. Level control for wah. LED shows which effect is engaged.

**PWOV** .....**\$198.00**

### MINI WAH VOLUME

**MWV** 4.5" x 6.75" x 2.75" .....**\$184.00**



### PRO SERIES II DISTORTION/WAH/VOLUME

Three essential effects in one handy pedal. Wah and Volume are Electro-Optical, Distortion is analog.

**PDWII** .....**\$242.00**



### DUAL BASS WAH

Designed for Bass or detuned guitars. Two foot selectable wah modes: Traditional and Funk plus a wah level control.

**PBA2** .....**\$220.00**



### LITTLE ALLIGATOR VOLUME

Electro-Optical volume pedal with familiar linear taper. Minimum volume knob allows you to set two distinct volume levels (Rhythm and Lead)

**PLA** .....**\$178.00**



### VOLUME PLUS

Electro-Optical volume pedal with audio taper. Great for violin-like swells for pedal steel effect. Now with switchable minimum volume control.

**PVO+** .....**\$178.00**



### GAS STATION MULTI-POWER SUPPLY

Powers up to eight 9V effect pedals or stompboxes; combined current capacity of 600mA (max 250mA on a single outlet). Fault LED on each power outlet shows when there is a short or overload. Includes eight 2 ft. power connector cables, master power adapter & Gas Station unit.

**MGS1** .....**\$188.00**



### MORLEY AC ADAPTER

9 Volt 300 Milliamp. Regulated adapter for use with all Morley products. LED shows power is on. Compatible with most other effect brands.

**MOR9V** .....**\$29.00**

CALL FOR DEALER COST ON MORLEY  
www.morleypedals.com

## CRY BABY PEDALS



### CRYBABY® WAH WAH PEDAL

This is the original wah-wah pedal used to create the vintage sounds of rock and roll.

<b>GCB95</b>		<b>\$114.28B</b>
<b>GCB95F</b>	Fasel Inductor	<b>157.13B</b>
<b>95Q</b>	Tone Shaping Q Control	<b>185.70B</b>
<b>MXRMC404</b>	CAE Wah	<b>242.85B</b>



### ARTIST SERIES WAH

<b>EVH95</b>	Eddie Van Halen	<b>\$242.85B</b>
<b>MXRZW45</b>	Zakk Wylde	<b>119.99B</b>
<b>GCB5W95</b>	Slash	<b>242.85B</b>
<b>BG95</b>	Buddy Guy	<b>285.70B</b>
<b>DB01</b>	Dime Bag	<b>228.56B</b>
<b>JH1D</b>	Jimi Hendrix	<b>199.95B</b>
<b>KH95</b>	Kirk Hammett	<b>228.56B</b>
<b>JC95</b>	Jerry Cantrell	<b>228.56B</b>
<b>CM95</b>	Clyde McCoy	<b>285.70B</b>



### DUNLOP VOLUME PEDAL

Features a patent pending Steel Band Drive that creates a low-friction environment with no strings or ratchet gears attached – allowing you to achieve thick, luscious volume swells.

<b>DVP1</b>		<b>\$142.85B</b>
<b>DVP1XL</b>	Vol + Expr.	<b>171.42</b>
<b>DVP3</b>	Volume X Expr.	<b>171.42</b>



### BASS CRYBABY® PEDAL

A Wah-Wah designed specifically for the bass guitar. Allows the lower tones of the bass to have wah effect. Adds to solos and can be used for quick tonal changes.

**Features:** custom designed circuit for the bass guitar. 100k ohm Hot Potz potentiometer. Sturdy die cast body. 9 volt DC 3.5mm positive tip A/C adapter and/or 9 volt battery required.

<b>105Q</b>	E.Q. Circuitry	<b>\$185.70B</b>
-------------	----------------	------------------



### HIGH GAIN VOLUME PEDAL

This passive volume pedal allows for dynamic control. Ideal for Pedal Steel Players and other volume-control applications.

**Features:** heavy die cast built for durability, 1 million cycle audio taper potentiometer. Does not require any batteries or external power source.

<b>GCB80</b>		<b>\$128.56B</b>
--------------	--	------------------



### JOE BONAMASSA SIGNATURE CRY BABY® WAH WAH

Vintage-style halo inductor for added harmonic content and growl. Internal switch for true bypass or non-true bypass operation. Lightweight, aluminum housing.

<b>JB95</b>		<b>\$242.85B</b>
-------------	--	------------------



### CRYBABY® MULTI WAH

The 535Q offers versatility never heard before. This pedal allows the player to customize and shape the sound of the wah. By a simple turn of the "Q" dial, you can shape your wah from a narrow, sharp wah to a broad, subtle wah. The Crybaby 535Q also offers six new guitar wah ranges, a variable boost from 0 to +26 dB and a hard wire on/off switch. Its new custom circuitry consumes less power and eliminates unwanted distortion.

<b>GCB535Q</b>		<b>\$214.82B</b>
<b>535QC</b>	Chrome	<b>242.85B</b>



### SPARE PARTS FOR CRYBABY

<b>ECB151</b>	Rubber Feet (4)	<b>\$2.90</b>
<b>ECB152</b>	Bottom Plate	<b>17.91</b>
<b>ECB24A</b>	Audio Taper Pot	<b>36.39</b>
<b>ECB24B</b>	Hot Potz II 100K	<b>36.39</b>
<b>ECB035</b>	ON/OFF Switch Assembly	<b>12.40</b>
<b>ECB02</b>	AC Adaptor, Pre 93 Model (M)	<b>16.93</b>
<b>ECB03</b>	AC Adaptor (F)	<b>16.93</b>
<b>ECB04</b>	18V AC Adaptor	<b>26.96</b>
<b>ECB297</b>	9 Volt Cable + Tip	<b>6.90</b>
<b>ECB298</b>	9 Volt Cable + Barrel	<b>13.50</b>
<b>FL01</b>	Yellow Fasel, Vintage	<b>22.43</b>
<b>FL02</b>	Red Fasel, Modern	<b>22.43</b>

## JIM HENDRIX



### FUZZ FACE

The Dunlop Jimi Hendrix Fuzz Face is a meticulously faithful reproduction of the 1969-70 Dallas Arbiter Fuzz Face that Jimi used on classic albums like Band of Gypsies.

<b>JHF1</b>		<b>\$214.28B</b>
-------------	--	------------------



### SIGNATURE WAH

This is the unmistakable wah tone heard on Hendrix classics like "Up From the Sky," "Voodoo Child (Slight Return)," "Little Miss Lover" and "Still Raining, Still Dreaming."

<b>JH1D</b>		<b>\$199.95B</b>
-------------	--	------------------



### OCTAVIO

Jimi Hendrix Octavio is an exact clone of the amazing "octave up" pedal that Jimi used to make rock history.

<b>JHOC1</b>		<b>\$242.85B</b>
--------------	--	------------------

[www.jimdunlop.com](http://www.jimdunlop.com)

# ROCKTRON

## HEX EXPRESSION



### VOLUME PEDAL

A multi-function pedal that can be used both as a volume pedal and as an expression pedal.

**HEXV** .....\$139.00B

## BLACK CAT MOAN



### MULTI WAH

Germanium diodes provide a unique sweepable sonic effect (THE MOAN) that can act as a stand alone distortion or be combined with the wah.

**BLACC**.....\$189.00

## TRI WAH



### TRIPLE WAH

Awesome-wah with three selectable modes: Normal, Classic and Bass.

**TRIWW**.....\$159.00B

## BANSHEE



### TALKBOX

The Banshee allows incredibly easy setup, unlike older models, and hooks up just like a stomp box in front of your amp.

**BANST**.....\$279.00B  
**B2TB** Banshee 2.....\$359.00B  
**0061101** AC Adaptor.....\$30.00B

## ALL ACCESS



### CONTROLLER

BANK Mode has 120 presets, each instant switch can set up global or per preset. SONG Mode allows up to 150 songs to be set up with 15 presets per song. REMOTE Mode automatically programs the footswitch to match remote-compatible units.

You asked, and now we have delivered! All Access in black, complete with included expression pedal (Rocktron's Hex), cable, and special plate allowing you to shift the pedal while it remains locked to the unit.

**ALLTD**.....\$1749.00B  
**0061101** AC Adaptor.....\$30.00B

## MIDI MATE



### CONTROLLER

The MIDI Mate is an intelligent controlling device allowing you to send preset changes on six different channels and five control changes while controlling one real-time parameter all at once.

**MIDIM** .....\$309.00B  
**0061101** AC Adaptor.....\$30.00B

## MIDI EXCHANGE



### CONTROLLER

The MIDI Xchange is a low-cost portable MIDI footswitch. Simple to use, yet multi-functional, the MIDI Xchange controls all MIDI switchable products. 2 Expression ports allow you to plug in up to two Rocktron HEX expression/volume controllers for continuous controlling.

**MIDIX**.....\$169.00B

## PROPHECY II



### DIGITAL/TUBE PREAMP

Prophecy II offers four unique channels, (Clean American, Texas Blues, Vintage British and Mega Drive), each with their own distinct voicings to provide a vast array of desired tube amp sounds.

**PROP2** .....\$1799.00B

## VOODU VALVE



### TUBE PREAMP

The VooDu Value unites our world-renowned DSP effects with the warmth of today's tube technology. Choose either High or Low tube gain depending on how much tube break-up you want.

**VOODV**.....\$1099.00B

## GAINIAC 2



The most effective EQ section ever devised, allows over 30dB cut, or scooping, of the midrange used with the bass and treble. The Gainiac 2 adds three band EQ to the clean sound as well and the clean sound now runs through the tube for more warmth.

**GAINI** .....\$389.00B  
**0061101** AC Adaptor.....\$30.00B

## METAL PLANET



### DISTORTION

Equipped with a 4 band EQ specifically designed for over-the-top distortion with separate level and distortion controls.

**METAP**.....\$129.00

## RAMPAGE



### DISTORTION

Offers up to 75dB of raging gain with amazingly low noise. Brutally offending "Scoop" control allows a mid cut of up to 30dB.

**RAMPD**.....\$129.00

## HUSH THE PEDAL



### HUSH

Wipe out hiss, unwanted feedback and pickup buzz and get rid of the noise without altering your tone while delivering 65db of signal cleanup.

**HUSHP** .....\$129.00



# ROCKTRON REACTION

## CHORUS



The Reaction Chorus has the features you demand with transparency, a creamy fluidness of its predecessors, and the ability to leave your tone intact!

**RCHO** .....\$139.00

## COMPRESSOR



Professional players use a compressor like a secret weapon to accomplish many things, including adding more sustain to any guitar without adding distortion, defining every note in a chord while letting it ring out.

**RCOM** .....\$139.00

## DIGITAL DELAY



The Reaction Digital Delay has all the smooth full bodied tone you expect in a delay pedal. If you are a rocker, we've got your back!

**RDIG** .....\$139.00

## DISTORTION



Not just any distortion pedal, we call this the Rocktron Reaction Distortion because you are gonna get a huge reaction out of your audience with this one!

**RDIS** .....\$139.00

## OCTAVER



If you are looking for that low down gritty Octave effect, you'll love the Reaction Octaver. Experiment with the HIGH FILTER, LOW FILTER and BLEND controls.

**ROCT** .....\$139.00

## ZOMBIE



### DISTORTION

Creates a monstrously heavy, rectified distortion while providing a psycho-acoustic 3D sound positioning effect.

**ZOMBR** .....\$129.00

## SUPER BOOSTER



Reaction Super Booster provides up to 20dBu of gain, while enhancing the tonal response of your guitar with your amplifier.

**RSUPB** .....\$139.00

## SUPER CHARGER



Often the tone you seek is that black magic smoky witches' brew of crunch and edge, or that dry throat bluesy drought stricken Texas dustbowl kind of richness. Turn to Rocktron's Reaction Super Charger and find your inner musical soul.

**RSUPC** .....\$139.00

## HUSH



The Reaction HUSH, when used properly, will wipe out hiss, unwanted feedback and pickup buzz.

**RHUS** .....\$139.00

## TREMOLO



Used in the past for "surf" music or for pop, the tremolo has resurfaced as a cool part of modern heavy rock and roll.

**RTRE** .....\$139.00

## VHT



### V-DRIVE OVERDRIVE PEDAL

From clean boost to creamy-smooth sustain to raging harmonic complexity, the new VHT V-Drive overdrive pedal's unique controls offer an amazingly wide range of tones and textures. Controls: Drive, Volume, Tone, Select, Texture, Depth, Voltage.

**AVVD1** .....\$154.95

## OPTION KNOB FOR PEDALS



The OKnob uses a friction-based grip to replace your factory knob and fit tightly in its place.

**OKB** For boutique pedals .....\$9.95  
**OKC** For traditional pedals .....9.95  
**GKC** Gloknob/classic .....11.95

## FENDER



**FENDER DISTORTION PEDAL**  
The Fender Distortion pedal drives your favorite tube or solid-state amp into thick distortion and singing sustain, evoking the edgy hard-rock tones of the '70s and '80s.  
**4501 .....\$89.99**



**FENDER DRIVE PEDAL**  
The Fender Drive pedal creates a warm overdrive reminiscent of classic '60s and '70s rock and blues tones. Use it to push your favorite tube or solid-state amp, creating harmonically rich crunch and sustain.  
**4502 .....\$89.99**



**FENDER CHORUS PEDAL**  
The Fender Chorus pedal will remind you just how cool and indispensable the lushly spatial effect can be. Add sparkle to clean open chords, to animate strummed passages and to thicken distorted power chords.  
**4503 .....\$99.99**



**FENDER DELAY PEDAL**  
The Fender Delay pedal creates richly resonating echo effects from short slap-back rockabilly sounds to longer repeating echo perfect for huge, soaring guitar solos (it's great for other electronic instruments too, such as keyboards)  
**4504 .....\$99.99**

## COOL CAT

### TREMOLO



Better than your vintage amp. You'll dig the "square wave" setting.  
**DCT1 .....\$49.00\***

### CHORUS



3D shimmer and swirl.  
**DCC1 .....\$59.00\***

### VIBE



Organic. Swampy. Trippy.  
**DCV1 .....\$69.00\***  
(\* Call for Net Pricing)

### FUZZ



Liquid to edgy.  
**DCF2 .....\$69.00\***

### DRIVE



Tone thickening. Warm saturation.  
**DCC2 .....\$59.00\***

### T/OVERDRIVE



Clean boost to glassy crunch.  
**DCT2 .....\$69.00\***  
(\* Call for Net Pricing)

## RAT 2



Researched and designed to produce a sound that is radically different from any "fuzztone."

**RAT2 .....\$147.90**  
**DTRAT** Deuce Tone .....**450.00**  
**RPS1** AC Adaptor .....**28.65**  
**TURBORAT** .....**214.20**  
Twice the output of the Rat.

[www.procound.com](http://www.procound.com)

## ERNIE BALL PEDALS



Volume pedal. Smooth, solid design.  
**EB6166 .....\$180.00B**  
**EB6180** Junior Mono .....**120.00B**  
**EB6181** Junior Mono 25k .....**120.00B**  
**EB6182** MVP .....**179.00B**  
**EB6172** Tune Up Kit Jr. ....**4.00**  
**EB6161** Volume Pot .....**25.00**

Stereo/pan volume pedal. Pre Level pot.  
**EB6165 .....\$240.00B**  
**EB6157** Tune Up Kit .....**4.00**  
**EB6167** Stereo Volume .....**210.00B**  
**EB6168** Keyboard .....**210.00B**

## FUZZ FACE



### ERIC JOHNSON SIGNATURE FUZZ FACE

This pedal features hand-selected BC183 silicon transistors (for higher gain), custom retro '68-'69 knobs, and a vintage style hammettone finish. The result: a beautifully dynamic, expressive, and powerful pedal.

**EJF1 .....\$285.70B**



The Original Dallas-Arbitrator Fuzz Face. Ruggedly constructed to the original Germanium PNP transistor design and vintage specs.

**JH2 .....\$185.70B**



### BONAMASSA FUZZ FACE

Joe Bonamassa Signature Fuzz Face is voice specifically for Joe's humbucker-driven tone, adding sustain and thickness for a rich, creamy fuzz. This pedal's hand-wired circuitry is built around matched NOS Russian military germanium transistors for their characteristic warmth and growl.

**JBF3B .....\$285.70B**

## DUNLOP FUZZ FACE® MINI

The FFM1 Fuzz Face Mini Silicon is spec'd from a 1970 Fuzz Face in our own collection, prized for its bright and aggressive Fuzz Face sound delivered by its matched BC108 silicon transistors.

**FFM1 .....\$142.85B**

The FFM2 Fuzz Face Mini Germanium is based on '66-'68 era pre-silicon Fuzz Faces famous for warm vintage Fuzz Faces tones provided by slightly mismatched germanium transistors.

**FFM2 .....\$185.70B**

The FFM3 Fuzz Face Mini Hendrix has the same circuit as the JHF1 in a smaller housing, delivering the thick, smooth Fuzz Face tone that Jimi Hendrix made famous in a pedal-board-friendly size.

**FFM3 .....\$171.42B**

## E BOW



A versatile accessory for guitar capable of producing a wide variety of effects including sustain, fade ins, fade outs, bowing, spiccato, and a variety of tonal textures.

**GEBO10 .....\$142.50B**

# IBANEZ



## JET DRIVER

The new Ibanez JD9 offers a wide variety of tones ranging from smooth overdrive to amp-like distortion. With an organic sound and true bypass switching, you won't have to worry about tone color when adding this pedal to your chain. Equipped with massive amounts of output volume, this pedal is ideal for pushing tube amps!

**IBJD9** .....\$128.55\*



## BOTTOM BOOSTER

The new Ibanez BB9 is perfect for the player who wants to push their amp into overdrive without losing any of their low end. The BB9 works wonders with bright tube amps like the JCM800. While a super responsive tone control allows for a wide variety of sounds, true bypass switching means your tone will not be compromised when adding this pedal into your chain.

**IBBB9** .....\$128.55\*



## BASS TUBE SCREAMER

The first ever Tube Screamer designed specifically for bass players. This pedal ranges from subtle overdrive to vintage fuzz and everything in-between. High and Low controls give the player the ability to dial in just the right sound for their amp. The additional mix control allows you to adjust the right amount of wet and dry signal to ensure your bottom end remains intact.

**IBTS9B** .....\$169.95\*



## PHASE MODULATOR

Three waveforms give you everything from classic phaser to DJ effects to ray gun sounds. The three different modes offer vintage, deep and dry, or deep and pronounced. The PM7 goes from traditional to 21st century phasing and beyond.

**IBPM7** .....\$116.65



## TUBE SCREAMER

Our TS9 Tube Screamer reissue features the TA75558 chip used in most of the original TS9's with the TS9DX adding three settings for increased low-end crunch.

**IBTS9** .....\$169.95\*



## TURBO TUBE SCREAMER

The Ibanez TS9DX Turbo Tube Screamer Effects Pedal features the same circuit as a TS9 Tube Screamer and also offers 3 new settings for increased low end crunch: +, Hot, and Turbo.

**IBTS9DX** .....\$199.00\*



## PEDAL TUNER

This new tuner features a durable diecast housing and LED display with a three-color indicator for maximum visibility from the floor. It also features a true bypass on/off switch for the truest tone and muting function.

**STROBE MODEL**  
**IBLU30** .....\$83.35



## CLIP TUNER

Ibanez Clip Tuner which can be mounted just about anywhere with its four hinges. Need your tuner locked firmly on a guitar headstock, music stand or tree branch? No problem! Just Clip it!

**IBPU10** .....\$49.99



## JAM TUNER

Ibanez Jam Tuner, a chromatic tuner that comes with the works, jammed right in. The Jam Tuner features a Hi-Spec wide LCD display, distortion effect, an AUX input for CD or MP3 players and a built-in metronome.

**IBRU10** .....\$66.65



## WEEPING DEMON

The Ibanez WD7 Weeping Demon Wah Pedal will have your audience screaming for more with its shrieks, cries, wails, and seductive siren songs. Among its features are spring and normal footboard action, selectable wah range, and fine tuning controls.

**IBWD7** .....\$157.15\*



## ACCESSORIES

**IBAC109** AC Adapter 9V,  
200mA .....\$25.70\*



## METRONOME/TUNER

The dual purpose Ibanez MU40 Tuner/Metronome indicates pitch with both an LCD needle display plus red flat and sharp LEDs plus a green in-tune LED. Built-in metronome with speaker, mute switch, and headphone input. Ideal for teachers and students.

**IBMU40** .....\$41.65



## DIGITAL CHROMATIC TUNER

These tuners are designed for electric guitars and basses, as well as acoustic guitars. The clever LU10 is an easy-to-use tuner with an LED display including a large, bright note display.

**IBLU10** .....\$33.35

\* CALL FOR DEALER COST

## DANO MINI EFFECTS

### T BONE



#### DISTORTION

Fill your plate with raucous 60's era distortion. Great sustain and tone. *Delish!*

**DJ2** .....\$49.00\*

### HASH BROWNS



#### FLANGER

Real 60's "thumb on the tape reel" feel flange effects. *Delightful!*

**DJ8** .....\$39.00\*

### SURF & TURF



#### COMPRESSOR

Fat rich bite...

**DJ9** .....\$49.00\*

### ROCKY ROAD



The coolest spinning speaker simulator ever. An extra foot switch lets you "ramp up" the spin of the speaker. Great for guitar or keyboard.

**DJ20** Spinning Speaker .....\$69.00\*

### FRENCH FRIES



It's a '70s style auto wah like you haven't heard since you tossed your bell bottoms.

**DJ24** Auto Wah .....\$49.00\*

### FISH & CHIPS



#### 7-BAND EQ

Graphic EQ for stage or studio use. Noise Free. Level control for boost.

**DJ14** .....\$49.00\*

(\*CALL FOR COST)

### BLT



#### SLAP ECHO

"Shower room" echos you haven't heard since late 50's recordings. *A Treat!*

**DJ3** .....\$39.00\*

### FRENCH TOAST



#### OCTAVE DISTORTION

A faithful re-issue of the Foxx Tone Machine from the early 70's.

**DJ13** .....\$49.00\*

### BACON & EGGS



#### MINI AMP

A very cool mm amp with powerful speaker built into the pedal!

**DJ16** .....\$29.00\*

### TUNA MELT



#### TREMOLO

Sounds so real you can feel the heat from your 1956 tube amp. Hard/Soft switch to perfectly simulate tremolos from different 50's era amps. *Tasty!*

**DJ5** .....\$49.00\*

### PB&J



Capable of up to a full second of delay. An extra switch lets you choose long or short delay, so you have 2 different delay settings in a performance.

**DJ17** Delay .....\$69.00\*

### MILK SHAKE



#### CHORUS

Thick, rich and creamy!

**DJ7** .....\$49.00\*



**SOUND CHECK** – T. Moscal – The basics of sound and sound systems. An excellent primer for musicians, students and aspiring audio engineers. **\$14.95**

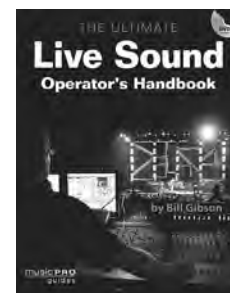

**ULTIMATE LIVE SOUND OPERATOR'S HANDBOOK** – B. Gibson – Covers all aspects. Bk/DVD. **\$39.95**

## DANELECTRO EFFECTS



### DAN ECHO

Cool vintage tape echo effects. The warmth of an all-tube echo with the convenience of a pedal. Hi-Cut control cuts high frequencies on repeats, perfectly simulating the tone of a 60's era tape echo. The warmest sounding echo/delay around. Studio quiet.

**DE1** .....\$129.00B



### REEL ECHO

Tape sound echo machine

**DTE1** .....\$199.00\*



### SPRING KING

Reverb Unit

**DSR1** .....\$199.00\*



### FREE SPEECH

Priced right takk box

**DTB1** .....\$129.00\*

## FAB EFFECTS

### FAB EFFECTS



**FABD1** Distortion.....\$25.00\*

**FABD7** Fuzz .....\$34.00\*



**FABD2** Overdrive.....\$25.00\*



**FABD3** Metal .....\$27.00\*



**FABD4** Slap Echo .....\$27.00\*

**FABD8** Delay.....\$39.00\*



**FABD5** Chorus.....\$27.00\*



**FABD6** Flange .....\$27.00\*

\* CALL OR WRITE FOR DEALER PRICING

[www.danelectro.com](http://www.danelectro.com)

# MAXON

## METAL DISTORTION



Tight, fast response with just the right amount of low-end punch and gain. Three-band EQ allows for classic "scooped-mid" tones for more full frequency "Nu-Metal" sounds.

**PY1** .....\$325.00B

## COMPRESSOR



Optical circuitry provide clean, smooth compression with ultra-low noise and incredible transparency. Delayed Attack time yields a more authentic picking response.

**CP101** .....\$228.00

## OVERDRIVE



JRC4558IC yields smooth, creamy, dynamic overdrive. Overdrive and Output controls adjust signal intensity while Tone adjusts the brightness.

**OD9** .....\$210.00

## OVERDRIVE DISTORTION



Covers a range of tones from subtle amp overdrive to searing Marshall Stack. Bias control morphs between Class A and Class B circuitry allows user to adjust the harmonic structure of the signal.

**RF2** .....\$325.00B

## OVERDRIVE



Featuring the original JRC4558IC, the OD808 offers smooth, warm, organic overdrive that reacts well to picking dynamics.

**OD808** .....\$200.00

## SONIC DISTORTION



Drive, Tone and Level controls providing gut-wrenching grind and singing sustain that will make a clean amp dirty and a dirty amp downright evil.

**SD9** .....\$210.00

## MAXON POWER KITS

**GPA9S** Single PSU .....\$25.00  
**GPA9B** Basic Kit .....\$37.50B  
**GPA9D** Deluxe Kit .....\$45.00B

## ANALOG DELAY



900 milliseconds of true analog delay tone featuring Maxon's proprietary bucket brigade IC's. From bathtub to slapback to arena-rock delay trails to runaway "spaceship" effects.

**AD999** .....\$375.00B

## PRO+ OVERDRIVE



Features more gain and low-end than its predecessor. 9- or 18-volt operation yields a wide variety of overdrive tones.

**OD9PRO+** .....\$275.00

## PRO+ SUPER TUBE



Takes the classic 808 circuit and adds an adjustable Midrange control, selectable 9- or 18-volt operation.

**ST9PRO+** .....\$275.00

## PRO+ COMPRESSOR



The CP-9 Pro+ has the highest gain available from a pedal compressor, making it possible to achieve a balanced output at any compression setting.

**CP9PRO+** .....\$325.00

# VISUAL SOUND

## DOUBLE TROUBLE



2 Overdrives in 1 Pedal

**V2DT** .....\$222.00

## JEKYLL & HYDE



Overdrive & Distortion

**V2JH** .....\$222.00

## COMP 66



**V2CMP66** Compressor .....\$148.00

## LIQUID CHORUS



Chorus for Guitars & Bass

**V2LC** .....\$178.00

## SON OF HYDE



Distortion

**V2SOH** .....\$148.00

## TRUTONE



Clean Boost

**V2TT** .....\$148.00

## ROUTE 66



**V2RT66**

Overdrive and Compression

**V2RT66** .....\$222.00

## VISUAL VOLUME



Volume Pedal w/LED Scale

**VV10** .....\$207.00

## ON/STAGE



### TRUE-BYPASS PEDAL TUNER

True-Bypass circuitry provides for zero signal distortion. Selectable Mute mode silences output while tuning. Flat tuning option, up to 7 downward 1/2 steps (perfect 5th) with LED.

**GTA7800** .....\$95.99

# BOSS PEDALS

## MEGA DISTORTION



Produces extreme, low-end distortion for modern metal and hard rock.

**MD2** .....\$140.50B

## METAL CORE



With its extreme gain, the ML-2 is the most potent and heavy distortion pedal ever created by BOSS. It easily delivers massive distortion and gain.

**ML2** .....\$163.50B

## FUZZ



The FZ-5 is a modern pedal built for the modern guitarist, but the sounds you can get from the FZ-5 are pure retro.

**FZ5** .....\$163.50B

## TURBO DISTORTION



TURBO Mode I produces warm and mellow distortion with flat frequency response. TURBO Mode II provides biting distortion with mid-range boost that's great for leads.

**BOSSDS2**.....\$145.50B

## OVERDRIVE



An overdrive that really sounds like it comes from a large-scale tube amp is created as a result of the unique BOSS "Asymmetrical Overdrive Circuitry".

**OS2 With Distortion** .....\$149.50B

## EXPRESSION



**EV5** .....\$122.50\*

## 2 WAY SELECTOR



The AB-2 2-Way Selector can be configured as a two- $\frac{1}{4}$ " inputs/one  $\frac{1}{4}$ " output selector or a two- $\frac{1}{4}$ " outputs/one  $\frac{1}{4}$ " input selector—letting you freely switch between two instruments or two amplifiers, for example.

**RAB2**.....\$54.50B

## VOLUME PEDALS



This mono pedal includes a recessed minimum Volume control for personalized application.

**FV50H** Guitar .....\$119.50B

**FV50L** Keyboard.....\$119.50B

## DAMPER PEDAL/ FOOT SWITCH



**DP10** Damper Pedal.....\$59.00\*

**DP2** Foot Switch .....\$30.00\*

## PEDAL BOARD



Holds up to three BOSS compact pedals. Comes with daisy-chain cable to power three compact pedals (with optional PSA-120). Comes with audio cables for connection between pedals. Made of heavy-duty molded resin.

**BCB30** .....\$51.50B

\* = CALL FOR DEALER COST

[www.bossus.com](http://www.bossus.com)

## MXR EFFECTS



### PHASE 90

Provides the classic four stage phasing sound with continuously variable speed control. The Phase 90 fixed regeneration level adds intensity and is particularly effective for keyboards.

**MXR101** .....\$114.20B  
**EVH90** Van Halen .....**185.70B**  
**MXRZW90** Zakk Wylde .....**142.85B**



### PHASE 100

The Phase 100, with 10 stages of phasing, has virtually limitless applications and offers two independent controls for Speed and Intensity.

**MXR107** .....\$171.42B



### SMART GATE

3 band noise gate. Eliminates sizzle and hum.

**MXR135** .....\$185.70B



### STEREO CHORUS

This gorgeous sounding pedal will remind you how a cool chorus can be.

**MXRM134** .....\$242.85B



### BASS PREAMP

The Bass Preamp is factory preset to operate in 1/4" out buffered bypass and Direct Out active. For players who only want to use the 1/4" out, there are two internal switches that disable the Direct Out and 1/4" out buffered bypass for true 1/4" out bypass mode.

**MXRM81** .....\$242.85B



### 10 BAND EQ

The Kerry King 10-Band EQ: can punish two amps at once thanks to its dual outputs. Use it as a boost for solos or to create thrash-approved, scooped-midrhythm tones. Create raging sustain and feedback.

**MXRKFK1** .....\$199.99B



### WYLDE OVERDRIVE

Wylde Overdrive. This muscular stompbox will turn your clean amp into a heavy, chunky crunch machine. Kick it in front of a dirty amp for a screaming, sustaining lead tone.

**MXRZW44** .....\$142.85B



### ZW38 BLACK LABEL CHORUS PEDAL

The MXR Black Label Chorus is Zakk's secret weapon to thicken up his wall of distortion and add liquid dimension and texture to clean passages.

**MXRZW38** .....\$142.85B



### BADASS DISTORTION

The MXR Custom Badass '78 Distortion roars with huge amp stack tones and old school distortion. We took a classic distortion circuit and hot-rodded it to deliver over-the-top soaring leads and rich, saturated rhythms.

**MXRM78** .....\$114.28B



### BASS COMPRESSOR

Take your favorite studio compressor to the stage with the MXR M87 Bass Compressor. A complete array of controls - Attack, Release, Ratio, Input, and Output - makes it easy to fine-tune your sound, from subtle peak limiting to hard squashed compression effects.

**MXRM87** .....\$271.42B



### NOISE CLAMP

Crank your stomp pedals up to the extremes without the fear of any hiss or excess noise with the MXR Noise Clamp. By sensing your guitar's dry signal, the Noise Clamp reduces the noise level within the effect loop.

**MXRM195** .....\$128.56B



### ANALOG CHORUS

This all-analog pedal uses bucket-brigade circuitry to create classically lush, liquid textures that you just can't get with digital circuitry. Rate, Level and Depth controls, as well as knobs for cutting High and low frequencies.

**MXRM234** .....\$142.85B

## MXR CUSTOM



### FET DRIVER PEDAL

Featuring a unique circuit design, the MXR FET Driver captures the rich, creamy sound of an overdriven tube amplifier by cascading an op-amp gain stage into a FET stage. The FET Driver thickens up lead tones with musical, amp-like distortion and sustain.

**MXRM264** .....\$214.27B



### VINTAGE 1974

Phase 90  
**CSP026** .....\$185.70B



### VINTAGE 1975

Phase 45  
**CSP105** .....\$142.85B



The MXR Custom Comp is built from the finest components available and designed with a blend of modern and classic compressor technology.

**CSP202** .....\$199.99B

## HEIL TALKBOX



Sturdy steel case. Heavy duty speaker driver. Rugged foot switch.

**HT1** .....\$257.13B

## MXR TALK BOX



With its own amp and speaker driver, the MXR Talk Box is compact and pedalboard-friendly - you don't have to lug around a separate rig or patch into your amp's speaker output. And with Volume, Tone and Gain controls, you can shape and add texture to your Talk Box voice for maximum impact. A sturdy, road-ready housing to endure the rigors of the road. Includes an 18-volt power supply, an 8' surgical tube and a mic standclip.

**MXRM222** .....\$242.85B

## MODIFIED O.D.



The MXR Custom Badass Modified O.D. uses a classic overdrive circuit with modern modifications for improved performance and versatility. Along with standard tone, output and gain controls, the Modified O.D. features a 100HZ control to focus tone when cut and beef it up when boosted. Engage the bump switch for an alternate EQ voicing that boosts lows and mids.

**MXRM77** .....\$142.85B



## MXR EFFECTS



### BASS BLOWTORCH

Turn up the heat with the Bass Blowtorch, a revolutionary new concept in bass overdrive from MXR Bass Innovations. Fire it up for the hottest bass sounds this side of Hades.

**MXRM181** .....\$214.00B



### BASS D.I.+

FURIOUS, GROWLING BASS TONE IS HERE. You've never seen a stomp box as useful or necessary as the new BASS D.I.+

**MXR80** .....\$199.99B

**MXRM84** Bass Fuzz Deluxe ..\$185.70B



### BASS ENVELOPE

The Bass Envelope Filter delivers classic, analog, envelope filter sounds.

**MXRM82** .....\$214.28B

**BASS OVERDRIVE ANALOG**

**MXRM89** .....\$185.70B



### BASS OCTAVE DLX

Analog tone, true bypass, and wide variety of tone-shaping options.

**MXRM288** .....\$214.28B



### UNI-VIBE®

The MXR Uni-Vibe Chorus/Vibrato comes in a Phase 90-sized housing – a fraction of the size and weight of the original Uni-Vibe pedal – and features true bypass switching.

**MXRM68** .....\$185.70B



### BLUE BOX

The Blue Box is a musical synthesizer which converts an incoming tone into a fundamental wave-shape and adds another tone, 2 octaves below it.

**MXR103** .....\$114.28B



### BOOST OVERDRIVE

A versatile pedal offering the combination of a simple dynamic overdrive and an independent clean boost circuit—all in one compact pedal.

**MXRMC402** .....\$199.99B

**MXRMC401** Boost .....\$142.85B



### CARBON COPY

The MXR Carbon Copy Analog Delay features a completely analog audio path for the ultimate in rich, warm delay – made possible only by old-school bucket brigade technology. This design boasts an amazing 600ms of delay time.

**MXRM169** .....\$214.28B



### CLASSIC 100 FUZZ

Guitarists of all styles, from Hendrix devotees to garage rockers and stoner-metal fanatics, will dig the familiar late-Sixties/early-Seventies crunch.

**MXRM173** .....\$185.70B



### DISTORTION +

Controls can be set at minimum to produce low-volume controllable distortion or Increased a bit to achieve a warm tube overdrive sound.

**MXR104** .....\$114.28B

**MXRDD11** Dime Bag .....\$185.70B



### DISTORTION III

It's natural and amp-like distortion is versatile and transparent enough to let your guitar's personality shine through.

**MXRM115** .....\$114.28B

**MXRM193** Overdrive .....\$142.85B



### DYNA COMP

The signal limiting processor which varies its gain so the output signal remains constant creating infinite clean sustain when combined with the sensitivity control.

**MXR102** .....\$114.28B

**MXR132** Super Comp .....\$128.56B



### ECHOPLEX® PREAMP

Dunlop's EP101 Echoplex Preamp recreates the magic of the EP-3's front end, featuring a Field-effect Transistor (FET) just like the original and following the exact same signal path.

**EP101** .....\$171.41B



### EVH FLANGER

Dunlop has once again partnered with living legend Edward Van Halen to present a new spin on a classic tone.

**MXREVH117** Van Halen .....\$271.42B



### EVH PHASE 90

Now you can grab a piece of Eddie's magic with the new MXR EVH 90 – a collaboration between Eddie Van Halen and Dunlop Manufacturing that represents an updated version of the legendary Phase 90.

**EVH90** .....\$185.70B



### FULL BORE METAL

This compact but powerful device is all you need to unleash the most devastating contemporary metal guitar tones ever heard.

**MXRM116** .....\$142.85B



### GRAPHIC EQ

6 Bands, each based one octave apart with boost and cut 18db on each band. Equalizes complete response range from electric guitar to bass. Also great for acoustic pickups on guitar.

**MXR109** .....\$114.28B

**MXR108** 10 Band .....\$171.42B



### MICRO AMP

A versatile, battery powered instrument and transducer pre-amp. It utilizes a bifet op-amp.

**MXR133** Micro Amp .....\$114.28B



### MICRO CHORUS

This 80's reissue delivers a stunning range of rich chorus textures, from sparkly water shimmers to intense rotating speaker simulation with a twist of the Rate control.

**MXRM148** .....\$128.56B



### MICRO FLANGER

Based on the benchmark sounds of the MXR M117 Flanger, the MXR Micro Flanger classic features many of the same flanging effects of its big brother, but in a smaller and more convenient size.

**MXRM152** .....\$128.56B

[www.jimdunlop.com](http://www.jimdunlop.com)

# ELECTRO HARMONIX



## NANO BIG MUFF PI

Singing sustain with attitude. Crushing distortion. Compact, rugged enclosure. Adjustable tone. True bypass for maximum signal integrity. Comes with a 9 Volt battery. 9.6DC-200BI EHX power supply optional.

**EHNBM.....\$95.65B**



## SOUL FOOD

The Soul Food delivers transparent overdrive with great touch and response. Its circuitry features boosted power rails to provide abundant headroom and increased definition, plus selectable true bypass or buffered bypass modes. Power supply included.

**EHSF.....\$89.26B**



## LUMBERJACK

The Lumberjack logarithmic overdrive breaks the rules to deliver distortion from powerful clean boost to subtle torn-speaker to gritty distortion. True bypass rounds out the equation. Power supply included.

**EHLJ.....\$79.89B**



## SATISFACTION FUZZ

EHS re-creates the classical fuzz tone with the Satisfaction Fuzz. Use it to create your own legendary riff.

**EHSFUZZ.....\$74.33B**



## HOT TUBES

Guitarists have requested that we re-issue our 1970s CMOS Hot Tubes. We've done this using the exact same design and miniaturized it, too! Volume and Overdrive to a full-blown gain monster with a powerhouse punch.

**EHHT.....\$77.74B**



## OD GLOVE

Advanced features like Tone Shift and selectable 9 or 18V internal voltage for surgical sound sculpting. The new OD Glove delivers overdrive and distortion with impact.

**EHODG.....\$82.87B**



## EAST RIVER DRIVE

Volume and Drive take it from sweet to searing while Tone lets you dial in just the right amount of bite. True bypass and tone.

**EHERD.....\$82.87B**



## EHX TROTION

JFET overdrive for tube-like response and tone. Boost switch with independent Volume and Gain for two-channel flexibility. 4-way Pre-Gain selector, plus Treble, Middle and Bass for complete sound control. Use it as a pre-amp – balanced XLR output with cabinet emulation. Power supply included.

**EHXT.....\$238.59B**



## HOLY GRAIL MAX

The Max's multi-function control lets you adjust decay or reverse time. Power supply included.

**EHHGMAX.....\$215.16B**



## SLAMMI

The next step in the evolution of foot-controlled pitch shifters! The Slammi Polyphonic Pitch-Shifter/Harmony Pedal revolutionizes its class with a powerful new algorithm yielding tremendous improvements in tone.

**EHSLAMMI.....\$192.80B**



## CRYING BASS

Designed especially for bass, this wah/fuzz provides the smoothest response and sound that goes all the way from smooth funk to rude growl.

**EHCB.....\$131.01B**



## NANO BASS BIG MUFF PI

Tailor your drive/distortion sound with Sustain, Tone and Volume knobs. Features a Dry switch that mixes your dry bass, at unity level, with the Nano Bass Big Muff's distortion. True bypass for maximum signal path integrity. 9 Volt battery included.

**EHNBBM.....\$106.95B**



## B9 ORGAN MACHINE

With 9 presets that were finely tuned to emulate the most legendary organs from the '60s and beyond, the B9 Organ Machine will transform your guitar or keyboard. Tracking is fast and flawless. Control of its signature percussive click and sweet modulation is precise.

**EHB9.....\$293.74B**



## DELUXE BIG MUFF PI

All the classic sounds of the original NYC Big Muff plus a lot more. Foot-switchable midrange section with variable center frequency and boost/cut knobs. Noise gate, Adjustable attack control, switchable bass boost, expression pedal input, true bypass.

**EHDBM.....\$215.11B**



## RING THING

The EHX Ring Thing effect pedal has four selectable modes that use either frequency or pitch shift modulation: Ring Modulation, Side Modulation, Single Sideband – Upper Band, Single Sideband – Lower Band, and Pitch Shift.

**EHRT.....\$293.74B**

# ELECTRO HARMONIX



## HOG2-HARMONIC OCTAVE GENERATOR

It delivers complete control of ten totally polyphonic and glitch free voices ranging from two octaves below to four above the instrument's pitch — all without the need for a special pick-up or instrument mods of any kind.  
**EHHOG2** w/Adapter.....**\$637.96B**  
**EHHOG2FC** Foot Control .....**95.85B**



**HOLY GRAIL**  
 Digital reverb guitar pedal  
**EHHG (Nano)**.....**\$163.36B**  
**EHHGPLUS**.....**197.04B**  
**EHHGMAX** Holy Grail Max.....**215.16B**



**HOLY STAIN**  
 Righteous multi-effect possibilities emerge when Reverbs, Pitch Shifting and celestial Tremolo meld with pure analog Drive and Fuzz. The brilliance of the Stain lies in the dynamic interaction of its controls.  
**EHHS** .....**\$154.46B**



**MICRO SYNTH**  
 Classic synthesizer sounds  
**EHMS** Microsynthesizer .....**\$381.30B**  
**EBMS** Bass Microsynth .....**381.30B**



**OCTAVE MULTIPLEXER**  
 Lowers note one octave  
**EHOM** .....**\$103.34B**



**MULTI-TRACK LOOPING RECORDER**  
 Each loop has four more mono tracks and one stereo mixdown track. The 45000 records non-compressed, 44.1 kHz/16-bit CD quality audio direct to a removable SDHC card (4 to 32GB). Each card holds up to 100 individual loops accessed with the optional **45000 Foot Controller** (sold separately).  
**EH45000** .....**\$637.96B**  
**EH45000FC** Foot Controller **159.75B**



**POG 2**  
 Programmable Polyphonic Octave Generator  
**EHPOG2** .....**\$435.63B**



**QTRON**  
 Envelope filter  
**EHQTRON** .....**\$191.61B**  
**EHQTRONPLUS** w/Loop .....**223.45B**



**RIDDLE**  
 Q Balls for Guitar  
**EHR**.....**\$263.09B**



**SMALL CLONE CHORUS**  
 Analog Chorus Pedal  
**EHSC**.....**\$106.28B**



**GERMANIUM OD**  
 Classic 60's overdrive from genuine germanium transistors. Bias and Volts controls let you easily dial in that perfect vintage germanium tone.  
**EHGOD**.....**\$99.06B**



**STEREO POLYCHORUS**  
 ANALOG CHORUS/FLANGER/  
 SLAPBACK ECHO  
**EHPC** .....**\$295.87B**



**STEREO MEMORY MAN WITH HAZARAI**  
 It's an echo, a multi-tap delay, a reverse echo, and a performance looper with up to 30 seconds of loop time, all in true stereo! Featuring tap tempo, vintage tape echo filtering, and eight programmable presets.  
**EHSMMWH** .....**\$293.74B**



**RAVISH SITAR**  
 Very few instruments offer as much harmonic and dynamic flexibility as a sitar. Electro-Harmonix has streamlined the essence of the sitar into a compact enclosure that offers a polyphonic lead voice and tunable sympathetic string drones that dynamically react to your playing.  
**EHRS**.....**\$316.73B**



**TUBE ZIPPER**  
 Controlled Analog harmonics  
**EHTZ**.....**\$273.72B**



**#1 ECHO DIGITAL DELAY**  
 Provides up to two seconds of delay with a warm analog style decay.  
**EH1E**.....**\$148.90B**

# ELECTRO HARMONIX



**BASS BIG MUFF PI**  
**EHBBM** .....\$108.00B  
 Deluxe Bass Big Muff PI with Distortion/Sustainer  
**EHDBBM**.....\$159.55B



**BASS BLOGGER**  
 Finesse distortion with silky definition.  
**EHBB** .....\$99.46B



**ANALOGIZER**  
 Got the digital blues? Coat your guitar in warm, organic tone.  
**EHA**.....\$93.74B



**BLACK FINGER/WHITE FINGER**  
 Dual Tube Compressor  
**EHBF** Black .....\$268.39B



**BIG MUFF PI**  
 Distortion sustainer with rich, creamy violin like sustain.  
**USBM** Made in USA.....\$107.15B  
**EHBMPWTW** Tone Wicker ..\$121.21B



**GERMANIUM4 BIG MUFF PI**  
 Versatile overdrive/distortion that captures the essence of the warm sound unique to the germanium transistors from the '60s.  
**EHG4BMP** .....\$138.23B



**CATHEDRAL**  
 Programmable stereo reverb  
**EHC**.....\$293.74B



**DLX MEMORY BOY**  
 Analog delay  
**EHDMB** With Tap Tempo.....\$275.87B  
**EHMB**.....186.14B



**DLX MEMORY MAN**  
 Deluxe analog delay with chorus and vibrato  
**EHDMM** .....\$424.96B



**TUBE EQ**  
**EHEQT** .....\$268.39B



**EPITOME MULTI EFFECT**  
 The quintessence of tone! This powerful digital multi-effect begins with the flawless polyphonic tracking of the **Micro POG**. Next is the **Stereo Electric Mistress**. Creamy stereo flanging and chorus weave and undulate for the richest modulations. Finally, the **Holy Grail Plus** wraps you in a silken shroud of luxurious reverb.  
**EHEPITOME** w/Adapter .....\$494.19B



**EH AC ADAPTORS**  
**EH9V** 9 Volt .....\$17.70  
**EH12V** 12 Volt .....\$14.70  
**EH18V** 18 Volt .....\$22.50  
**EH24V** 24 Volt .....\$19.65  
**EH9V500** 9 Volt .....\$25.50  
**EH18AC1000** 18 Volt .....\$28.50  
**EH9LDC500** 9 Volt .....\$19.50  
**96DC200BI** 9 Volt .....\$20.70  
**EH75V** 7.5 Volt.....\$20.70

**DLX MEMORY MAN WITH TAP TEMPO**  
 Ultimate audio delay  
**EHDMMWTT** .....\$52.11B



**ENIGMA**  
 Q Balls for Bass  
**EHE**.....\$263.09B



**ENGLISH MUFF'N**  
 Pre Amp, Marshall Sound  
**EHEM**.....\$268.39B



**FREQUENCY ANALYZER**  
 Ring Modulator  
**EHFA**.....\$197.04B



**GRAPHIC FUZZ**  
 Fuzz with EQ  
**EHGF** .....\$201.30B

# ELECTRO HARMONIX

## NANO



### Chillswitch

The Chillswitch Momentary Line Selector is a new, utilitarian Electro-Harmonix pedal.

**EHCS** .....\$58.61B

### Crying Tone

Wah wah pedal w/no moving parts.

**EHCT** .....\$24.62B

### Double Muff (Nano)

2 Muff Fuzz in One

**EHDM** .....\$75.63B

### Expression Pedal

Real-time variable control.

**EHEP** .....\$124.62B

### Flanger Hoax

**EHFH** .....\$283.32B

### 44 Watt Amp

Arm yourself with 44 watts of clean firepower and true overdrive at the twist of a knob. Flip the Brightness switch for a tight and focused top-end.

**EH44M** .....\$201.30B

### Freeze (Nano)

Capture and freeze any note or chord when you step on the momentary footswitch and sustain that sound until you release it.

**EHF** .....\$163.36B

### Headphone Amp

This go-anywhere personal practice amp delivers a musical quality and attitude that defines the spirit of Electro-Harmonix.

**EHHA** .....\$58.61B

### Hum Debugger

Absolutely eliminates hum from any audio source.

**EHHD** .....\$154.46B

### Iron Lung (Nano)

Built around the finest aspects of our praised V256 vocoder, the Iron Lung is the baby brother housed in our smallest, die-cast chassis.

**EHIL** .....\$180.02B

### Knockout Attack Equalizer

This powerful two-filter combination makes your humbuckers sound like single coils and your Strat sound like a Tele. Use it after distortion for the heavyweight punch of the metal masters.

**EHKO** .....\$90.56B

### Little Big Muff

Same classic, silky smooth violin-like sustain and creamy tone that made the legendary 1970 Big Muff famous.

**EHLBM** .....\$95.65B

### LPB-1 Linear Power Booster (Nano)

An exact recreation of the original LPB-1 circuit, which ushered in the age of overdrive in 1968. Put the LPB-1 in front of any effect to dramatically increase definition from its cleaner and heavier input drive. Control the gain and saturation of any amp.

**EHLPB1** .....\$53.68B

### Memory Toy (Nano)

Delivers pure analog design to musicians who covet thick sound from a thin wallet.

**EHMT** .....\$159.55B

### Metal Muff with Top Boost

Provides an awesome array of alloys ranging from slithering mercury to lead belly blast furnace dross.

**EHMMTB** .....\$121.21B

### Micro Metal Muff

The classic Metal Muff, housed in a smaller die-cast enclosure with simplified controls. 15dB boost and cut around a carefully selected mid frequency guarantees huge scoop possibilities. Switch selectable top boost ranges.

**EHMMM** .....\$89.46B

### Micro Pog

Make your 6-string ring like a 12. Make your 4-string bass pump like an 8.

**EHMPOG** .....\$285.00B

### Micro Q-Tron

Player controlled dynamics moving a precise multi-mode filter with a sweet adjustable Q makes the Micro Q-Tron an amazing envelope follower.

**EHMQ** .....\$117.80B

### Muff Overdrive (Nano)

Reissue of the 1969 classic Muff Fuzz in a die-cast aluminum box. Adds just a touch of funky dirt.

**EHMO** .....\$58.36B

### Nano Bassballs (Nano)

Sleek, small and funky, the exact twin of the legendary Bassballs. Same controls, same sound but now in a pocket size, die-cast case.

**EHNBB** .....\$95.22B

### Nano Clone (Nano)

Presents a lush, true analog chorus at a very affordable price.

**EHNC** .....\$56.68B

### Nano Dr. Q (Nano)

The dynamic 1970's funk box now available in a pocket sized case. Dynamic picking response produces super funky wah like tones.

**EHNDRQ** .....\$67.11B

### Nano Small Stone (Nano)

The Nano Small Stone generates our traditional, thick, sweeping phase shifting with liquid transparency and tingling feedback control.

**EHNSS** .....\$94.80B

### Neo Clone (Nano)

Delivers the Small Clone sound at a price that sweeps the competition away.

**EHNEO** .....\$85.00B

### Neo Mistress (Nano)

True to the classic Mistress, the Neo's design adjusts the harmonic sweep to present the varied tonal density that flanging brings to musical performance.

**EHNMM** .....\$106.28B

### Pan Pedal

Stereo Panning left, right or center.

**EHPP** .....\$117.17B

### Pocket Metal Muff (Nano)

Heavy metal firepower that fits in the palm of your hand. The little brother of the Metal Muff family is nasty. Carefully selected mid frequencies are switch selectable offering powerful, musical scoops.

**EHPMM** .....\$72.22B

### Randon Tone Generator

A faithful reissue of a rare EHX synthesizer first introduced in 1980. The palm-sized synth produces wild, randomly changing tones over a four-plus octave range. Creates sensational soundscapes, especially when used with other effects!

**EHRTG** .....\$71.79B

### Screaming Bird (Nano)

Screaming Bird treble booster is back to help your sound take new flight.

**EHSB** .....\$53.68B

### Signal Pad (Nano)

Passive attenuator that allows you to instantly switch to a different preset volume.

**EHNSP** .....\$59.44B

### Soul Preacher (Nano)

Compression sustainer.

**EHSOUL** .....\$104.39B

### Stereo Clone Theory

The ultimate chorus pedal. Lush, warm and defined chorusing and vibrato.

**EHSTC** .....\$148.90B

### Stereo Electric Mistress

Generate slithering, panoramic Axis: Bold As Love textures. Manually flange or freeze sound in Filter Matrix mode. Use Chorus and Flanger together.

**EHSEM** .....\$157.40B

### Stereo Polyphase

Brings cascading sweeps and gorgeous, panoramic imaging through stereo outputs.

**EHSP** .....\$262.00B

### Stereo Pulsar

Creates beautiful, vintage vibrato. Add motional panning with user-selectable variable waveforms.

**EHSPP** .....\$117.80B

### Superego

Synth engine from MOOG to EMF, 9.6DC-200 PSU included.

**EHSE** .....\$285.20B

### Switchblade (Nano)

Switch your signal between two different amplifiers, two different pedal boards or two different speaker cabinets. Flexible channel switching built into a compact die-cast case.

**EHS** .....\$48.77B

### Switchblade+

The Switchblade+ offers a convenient solution to a player's switching needs. Route your signal to either output A or B, or send it to both at once.

**EHSPLUS** .....\$58.61B

### Talking Pedal

Vocal format wah w/fuzz.

**EHTP** .....\$131.01B

### Tone Tattoo

Multi-effects pedal, distortion, delay, chorus. 9.6DC-200 PSU included.

**EHTT** .....\$285.20B

### The Mole (Nano)

The Mole is a bass booster that helps bassists and guitarists unearth a sound that is positively subterranean.

**EHTM** .....\$53.68B

### Voice Box Pedal

Creates intelligent 2 to 4 part harmonies directly from your vocals and in the same key as your accompaniment instrument.

**EHVB** .....\$293.74B

### Volume Pedal

Precision volume control.

**EHPV** .....\$117.17B

# ELECTRO HARMONIX



**2 TUBE PREAMP**  
Dual tube stereo preAmp  
EHLPB2 .....\$268.39B



**THE WIGGLER**  
Vibrato and AM Tremolo  
EHW .....\$268.39B



**THE WORM**  
Analog multi effects processor  
EHTW .....\$137.40B



**STEREO TALKING MACHINE**  
The programmable Stereo Talking Machine, Vocal Formant Filter, presents creative vowel shaping that is controlled by the player's dynamics.  
EHSTM .....\$293.74B



**V256 VOCODER**  
Bring your vocals up to snuff with advanced processing "Reflex-Tuning," today's most popular pitch correction effect.  
EHV256 .....\$293.74B



**STEREO POLYCHORUS ANALOG CHORUS/FLANGER/SLAPBACK ECHO**  
The Stereo Polychorus provides the lushest stereo chorus, rich chiming flange, and the over-the-edge effects that made this versatile pedal legendary.  
EHPC .....\$295.87B



**ANALOG EXPRESSION/CV SEQUENCER 8 STEP PROGRAM**  
Four sequence direction modes: Forward, Reverse, Bounce and Random. Rotary encoder gives you control over glide rate, direction, sequencer length and depth. Save, store and recall 10 presets. The optional 8 Step Program Foot Controller expands that to 100 presets! **9 volt power supply included.**  
EH8S .....\$187.24B  
8 Step Program Foot Controller  
EH8SFC .....\$95.85B



**YFC3** Dual Zone Sustain .....\$70.00  
**YFC7** Yamaha Volume .....70.00  
**VFP110** Sustain (Casio) .....36.95  
**VFP115** Sustain (Yamaha) .....36.95  
**VFP125** Switchable Polarity .....48.35  
**VFP210** OBL Switch (Casio, Korg) .....86.60  
**YFC4** Yamaha Sustain .....40.00

## PEDALS

## POCKET ROCKIT HEADPHONE AMPS



**PRO**  
Three (3) Sound Settings: PRX Overdrive, Distortion, Clean. Stereo Chorusing. Preset Compression. Variable EQ Filter. Line In/Out. Low Level Output. 2-Channel Mixer.  
PR9014 .....\$89.95



**STD**  
Three (3) Sound Settings: PRX Overdrive, Distortion, Clean. Preset Compression. Variable EQ Filter. Line In/Out. 2-Channel Mixer.  
PR9060 .....\$49.95B



**MXR DC BRICK™ POWER SUPPLY**  
Each 9v output has a red LED that illuminates if there is a short so you can quickly identify and troubleshoot any power problems. The MXR DC Brick has eight 9v outputs and two 18v outputs. And of course, the AC adapter and all necessary cables to connect pedals to the unit are included.  
MXRM237 .....\$171.42B



**BASS**  
Three (3) Sound Settings: Bright, Fat, Slightly Distorted. Stereo Chorusing. Preset Compression. Variable EQ Filter. Line In/Out. Low Level Output. 2-Channel Mixer  
PR9013 .....\$80.00B



**STD BASS**  
Three (3) Sound Settings: Bright, Fat, Slightly Distorted. Preset Compression. Variable EQ Filter. Line In/Out. Low Level Output. 2-Channel Mixer.  
PR9050 .....\$54.95B

## MULTI SUPPLY



This "daisy chain" cable allow for powering multiple BOSS compact pedals from a single pedal like the LS-2, TU-2, or NS-2.  
**PCS20A** Multi Cable, 8 .....\$24.50B  
**PDC373** Multi Cable, 4 .....13.70

## VOX HEADPHONE AMPS



**AC 30**  
AC30 emulates the AC30 top boost sound of a vintage VOX AC30.  
**KAPAC**.....\$54.99B



**CLASSIC ROCK**  
Classic Rock gives you the great high-gain sound of a UK-made 100W amp.  
**KAPCR**.....\$54.99B



**NIGHT TRAIN**  
amPlug Night Train offers the intense, high-gain sound of the VOX Night Train amplifier.  
**KAPNT**.....\$54.99B



**ACOUSTIC**  
'Acoustic' features Fat/Bright switch which offers two types of acoustic sounds.  
**KAPAG**.....\$54.99B



**"BF TWIN"**  
amPlug Twin recreates the sound of the classic American clean 2 x 12" combo amp, plus a chorus effect.  
**KAPTW**.....\$54.99B



**METAL**  
Metal delivers the explosive roar of US high-gain metal sound.  
**KAPMT**.....\$54.99B



**LEAD W/DELAY**  
Lead delivers hi-gain lead guitar sounds, plus a digital delay effect.  
**KAPLD**.....\$67.99B



**BASS W/COMPRESSION**  
'Bass' features a full-range bass sound with a compressor/boost effect.  
**KAPBA**.....\$67.99B

Simply plug the amPlug directly into any guitar/bass, attach a pair of headphones, and you're ready! Use the AUX input jack to plug any CD/MP3 player right into the amPlug and jam along. Connect the optional amPlug Cabinet (sold separately) to create a miniature amp stack to share the sound with friends. The 100% analog circuit faithfully simulates the response of the original amps.

## VOX HEADPHONE AMPS



The "AC30" version which faithfully reproduces the classic VOX AC30.  
**KAMAC30**.....\$135.99B



The "Twin" version which gives you the clean sound of a classic US-made amp.  
**KAMTWIN**.....\$135.99B



The "Lead" version which delivers a heavy British crunch lead sound.  
**KAMLEAD**.....\$135.99B



The "Bass" version which provides a wide range of sound, including a new Bassilator circuit that realistically simulates the resonance of the speaker cabinet and floor.  
**KAMBASS**.....\$135.99B

Achieve high quality guitar/bass sounds anywhere. Now amPhones make it even easier for you. While the amPlug required the user to provide the headphones, the amPhones are headphones that have the amPlug technology already built in! Just plug in your instrument, and enjoy serious guitar/bass sound and superb comfort. A full complement of effects are provided: chorus/delay/reverb for the guitar versions, and a compressor for the bass version. AUX input jack lets you jam along with your CD/MP3 player.

## VOX MINI 3G2 PORTABLE GUITAR AMPLIFIERS



**MINI3G2BK** Black.....\$155.99B



**MINI3G2CL** Vox Livery.....\$155.99B

Eleven built-in authentic amp models distilled from VOX's Valvetronix technology. Wide range of tones from sparkly cleans all the way to high-gain distortion. Usable with a variety of instruments such as electric guitars, acoustic-electric guitars, and keyboards. New Bassilator circuit – delivers a rich low end, especially with high-gain models. Enhanced compressor, chorus, flanger, tremelo, delay and reverb. **Dual power options – use the included AC adaptor or enjoy up to 10 hours of musical portability with six AA batteries.** Dedicated mic input with separate volume and reverb/delay controls – ideal for vocals. AUX input jack – connect your MP3 player or other audio source and jam along. High-performance, built-in E string tuner. Convenient carrying strap is included for true on-the-go mobility. Available in two color choices: chic black, or traditional VOX livery featuring the signature brown diamond grille cloth.

## BLACKSTAR® AMPS



Innovative 1 watt valve combo. 1xECC83 and 1xECC82. Unique push-pull power amp design. Based on award winning HT-5. Two channels. 8" speaker. Patented Infinite Shape Feature (ISF). Perfect for studio or practice. Speaker emulated output. Stereo MP3/line input. External speaker output.  
**KHT1** Combo.....\$337.40B



Innovative 1 watt valve combo. 1xECC83 and 1xECC82. Unique push-pull power amp design. Based on award winning HT-5. Two channels. 8" speaker. Patented Infinite Shape Feature (ISF). Perfect for studio or practice. Speaker emulated output. Stereo MP3/line input. External speaker output. Stereo reverb.  
**KHT1R** Combo w/Reverb..\$399.99B

## KORG



### MINI KAOSS PAD 2

Control and modulate a wide assortment of cutting-edge effects with the intuitive touchpad interface. MP3 player with microSD card slot for audio data storage/exchange; add effects to audio without additional equipment! 100 effect programs ideal for putting your own "touch" on any live performance. Virtual crossfader for transitioning between onboard media files and audio inputs. Combine with an external media player – or another Mini Kaoss Pad 2 – for DJ-style performances! 3 Program memory locations instantly recall favorite effects. Includes powerful Looper, Vinyl Break, and Ducking Compressor effects distilled from the Kaoss Pad Quad. Internal mic and external audio inputs for input flexibility. Record performances – with effects performances included – and save them to microSD. 6 preset audio demo loops to experiment with right out of the box.

**MINIKP2**.....\$230.00B



### KAOSSILATOR 2

Simply tap or slide your finger across the X-Y touchpad. 150 built-in sounds cover every style of dance music. PCM sound engine serves up realistic drums. Scale Key and Note Range eliminates "wrong" notes. Built-in Gate Arpeggiator with adjustable gate time and swing settings. Loop Recording allows the creation of layered phrases with unlimited overdubs. Dual Loop Recording banks allow DJ-Style mutes and cross-fades. Record using the built-in mic; or use the mic input for recording of external input. MicroSD/SCHC card slot for saving loops and recorded performances.

**KK02**.....\$230.00B



# VOX TONE GARAGE

## TRIKE FUZZ



An octave fuzz with three types of octave settings. This is an octave fuzz overflowing with vintage character, utilizing specially selected diodes.

TG2TRFZ.....\$200.00B

## DOUBLE DECA DELAY



A multi-function analog delay effect powered by BBD chips. In order to get that classic analog delay sound, we selected the famous 3205 BBD chip.

TG2DDDL.....\$210.00B

## FLAT 4 BOOST



A versatile, full-range booster. This vacuum tube booster can be used for a mid-boost, treble-boost, and overdrive, in addition to a full-range boost.

TG1FL4BT.....\$210.00B

## STRAIGHT 6 OVERDRIVE



Classic British overdrive with wide range of dynamics. High voltage design featuring a 12AX7 for maximum tube tone.

TG1ST6OD.....\$210.00B

## V8 DISTORTION



Get authentic tube-fired tone from Vox's Tone Garage V8 Distortion pedal. With a genuine 12AX7 preamp tube at its heart, the V8 Distortion delivers touch-responsive high-gain distortion to any amp.

TG1V8DS.....\$210.00B

## LIL' LOOPER



Looper multi-effect pedal allows effortless looping performances with killer effects! The new Lil' Looper – ideal for both guitar and vocal/mic performances as well.

VLL1.....\$219.99B

This new series features five effects units with all-analog circuitry: the Flat 4 Boost, V8 Distortion & Straight 6 Drive feature a VOX 12AX7 tube; the Double Deca Delay features three BBD chips & the Trike Fuzz features specially selected diodes. Vox engineers named the series "Tone Garage" for its boutique-inspired, hot-rodded and modded designs that deliver classic and unique tones not found elsewhere.

# BLACKSTAR® PEDALS

## BOOST



The LT Boost pedal offers a continuously variable boost as well as Bass and Treble cut and boost controls to provide true tonal refinement. The high integrity buffered bypass and silent switching features ensure that your tone won't suffer when the pedal is disengaged.

KLTBT1.....\$99.99B

## DISTORTION



The LT Dist pedal offers a simple and versatile layout of Gain, Level and Tone controls. In addition, the LT Dist offers the lowest cost option ever for players who want to get their hands on Blackstar's patented ISF control.

KLTDS1.....\$124.99

## DUAL



The LT Dual pedal offers two gain and level equipped channels with shared tone controls. In addition, the LT Dual offers Blackstar's patented ISF control, taking your tone from classic British metal to modern US high gain.

KLTDS2.....\$189.99B

## METAL



Simple and versatile Gain, Level and Tone controls. Extreme gain and tone. High integrity buffered bypass. Silent switching. Patented ISF control.

KLMT1.....\$124.99B

## DRIVE



The LT Drive pedal offers a simple and versatile layout of Gain, Level and Tone controls. The high integrity buffered bypass and silent switching features ensure that your tone won't suffer when the pedal is disengaged.

KLTOD1.....\$99.99B

**FAX & E-MAIL ORDERS  
FOR PRINTED MUSIC  
WILL GET AN EXTRA  
5% DISCOUNT**

**FAX:  
(708) 496-2130  
(888) 983-5537**

**E-MAIL:  
sales@harristeller.com**

# BLACKSTAR® PEDALS

## BOOST PURE VALVE BOOST



Genuine tube design, operates at 300 Volts for true hot tube dynamics and feel. ECC83 (12AX7) Tube offers two cascading tube gain.

**KHTBT1** .....\$229.99B

## TUBE DELAY



Each of the eight Delay effects have been designed by technical reference to emulate vintage equipment.

**KHTDL1** .....\$375.99\*

## DISTORTION



The HT-DIST is a classic distortion pedal that allows more tonal adjustment than any other pedal around.

**KHTDS1** .....\$249.99B

## DUAL GUITAR



The HT-DUAL features two switchable channels, each of which has its own gain and level controls.

**KHTDS2** .....\$319.99B

## DISTX GUITAR



The HT-DISTX is a no compromise, ultra high gain, fifth machine. The tone has been benchmarked against the best high-gain valve amps.

**KHTDX1** .....\$249.99B

## MODULATION



8 Modulation Effects from gentle tremolo to roaring jet engine flange, the HT-MODULATION brings you all the musicality of classic vintage effects pedals.

**KHTMD1** .....\$375.99\*

## OVERDRIVE



The unique "A-Class" tone control cuts the fizz without making your "backed-off" tone sound dull and lifeless. Add to this a no-compromise speaker emulated output and you have the ultimate over-drive pedal.

**KHTOD1** .....\$229.99B

## REVERB



8 Reverb Effects. The HT-REVERB can take you from your room to an arena via hall, plate, spring, gate and reverse reverb effects.

**KHTRV1** .....\$375.99\*

## METAL



Two channels and three modes provides extreme versatility. Each channel has its own volume and gain controls.

**KHTMT1** .....\$319.99B

## PEDAL BOARDS

### BOSS



SKB has developed the world's first AC/DC pedalboard with a built-in combo amp featuring a 6" Eminence speaker. The Amplified Pedalboard is a fully powered pedalboard that will accommodate up to eight 9 volt DC pedals and can be taken anywhere.

**BCB30** 3 Pedal .....\$51.50B  
**FXBRD** AXL, Powered.....109.75  
**PEDAL BOARD**  
 Pedal Board in a Bag  
**EHPB**.....\$57.20

**SKBFN8** .....\$299.99

## LIGHT SNAKE



SoundTech's patented "Live When Lit" technology shows you when the cable is working properly. The ends and cable light up when connected properly and flash when data is being transmitted.

### LIGHTSNAKE USB INSTRUMENT CABLE

Connect your guitar/instrument directly to your computer • Start recording instantly • Analog to digital converter built into cable • Digital quality sound input • No need for a sound card.

**STUSBG10** .....\$69.99

### LIGHTSNAKE USB MICROPHONE CABLE

Connect your Microphone directly to your computer. Start recording instantly. Analog to digital converter built into cable.

**STUSBXLR10** .....\$69.99

### LIGHTSNAKE USB MIDI CABLE

Interface your Keyboard or other MIDI-controlled device directly to your computer.

**USBMIDI10** .....\$79.99

### ILLUMINATED IPOD DOCK CABLE

Hi-Speed USB A to iPod Dock Cable, 6 ft. Error-free, high performance transmission. Hi-speed data transfer to 480Mbps.

**STUSBIPOD6**.....\$49.99

### ILLUMINATED USB

Hi-speed data transfer to 480Mbps – 40 times faster than USB 1.1. High performance 28/24-gauge power wires. USB logo guarantees cables are 100% compliant with current USB specifications.

**STUSBAA6** A-A, 6 ft. ....\$49.99

**STUSBAB6** A-B, 6 ft. ....49.99

### GUITAR AMP – PORTABLE MUSIC STATION

Connect MP3 player, CD player or computer and jam-along. Line-out & headphone jack. 3 cables, 9V battery & AC adapter included. 4 Amp Sounds – Clean, Hot Tube, Over Drive and High Gain.

**STAMP3**.....\$149.95B

## STAGE TRIX

### PEDAL RISER



Most pedalboards have only one level and therefore require an awkward tap dance to access the second row of pedals without stomping on others accidentally. The Pedal Riser enables you to raise your second row of pedals to the perfect height.

**STSR1** .....\$16.99

### PEDAL FASTENER

The Pedal Fastener is a hook fastener designed specifically for attaching pedals to pedalboards.

**STSF1** 3 Pack.....\$9.99

### WAH FASTENER

Simple remove screws from the rubber feet and optionally use the included washers and secure the plates of the Wah Fastener to your favorite wah pedal.

**STSF2** 3 Pack.....\$11.99

**PG1M** Power Grip Tape, 1 Meter (GodLyke)....14.95



## YAMAHA MIDI CABLES



### MIDI USB

The YUX16 can handle 16 channels of simultaneous playback. One MIDI out port (16 channels), one MIDI in port (16 channels).

**YUX16** .....\$80.00

### I-MX1 MIDI INTERFACE CABLE

i-MX1 is a MIDI interface cable which enables iPad/iPhone to be connected to MINI instrument.

**YIMX1** .....\$110.00

## HOSA TRACKLINK



### 1/4" TO-USB A

Plug and play – no driver required. Status LED indicates secure connection and recording status.

**USQ110**.....\$44.45



### MIDI IO-USB A

Plug and play – no driver required. Supports up to 16 MIDI channels.

**USM422** .....\$44.45



### XLR-USB A

Plug and play – no driver required. Features include gain control, 48 V phantom power, and status LED.

**UXA110**.....\$44.45

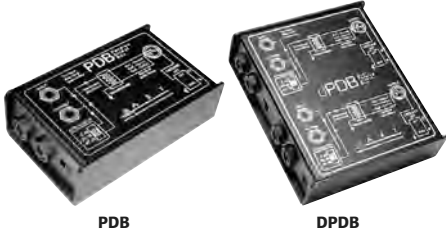

### PASSIVE DIRECT BOX

The PDB allows connection of a music source to an instrument amplifier while simultaneously patching it to a mixer. It automatically balances and matches the line level output.

### DUAL PASSIVE DIRECT BOX

The dPDB dual passive direct box features two high-quality direct boxes in one portable enclosure. It is a rock solid, roadworthy DI connection of the outputs of electronic musical instruments (or other audio sources) to the balanced inputs of mixer consoles.

**PDB** .....\$45.00B  
**DPDB**.....60.00B



PB4x4



SP4x4

### POWER DISTRIBUTION

ART 4x4 Series Power Distribution Systems feature a unique "4x4" AC jack layout on the back of the unit where four of the eight rear outputs are set 1.25 inches apart, allowing the user to plug in wide power cables and multiple wall wart devices.

### PB4x4 - Power Distribution System

Power Capacity of 1800 Watts • Surge & Spike Protection • 8 Rear Outlets with Power Adapter Friendly Positioning.

### SP4x4 - Metered PDS

Power Capacity of 1800 Watts • Surge & Spike Protection • 8 Rear Outlets with Power Adapter Friendly Positioning • Pull Out Light Pipes and Dimmer.

**PB4x4** .....\$ 75.00B  
**SP4x4** .....159.00B



### TWO WAY STEREO CONVERTER

Single/Balanced - Balanced/Single The CleanBOX converts a consumer level RCA signal to a balanced XLR professional line level and visa-versa. The CleanBOX has two XLR inputs and stereo RCA outputs, as well as stereo RCA inputs and two XLR outputs.

**CLEANBOX**.....\$65.00B



SLA1



SLA2

### 100 WATT STUDIO LINEAR AMPLIFIER

The SLA-1 Studio Linear Amplifier is a robust yet compact power amplifier designed for studio or even select live applications. It has been designed and engineered to provide clean, quiet power and excellent sound with ultra-low noise and distortion.

### 200 WATT STUDIO LINEAR AMPLIFIER

The SLA-2 is a studio linear power amplifier capable of delivering 200 watts per channel (@8 ohms) with an incredible 10Hz to 40kHz frequency response. Compact single rackspace low noise linear design, the SLA-2 uses a steel chassis and toroidal transformer for added long term reliability.

**SLA1** .....\$339.00B  
**SLA2**.....459.00B



### DUAL 31-BAND GRAPHIC EQUALIZERS

Designed to pro use wherever you need a cost effective way to shape your sound. The rugged, all-steel constructed chassis is well suited for any live sound application.

**EQ355** .....\$295.00B



### TWO-CHANNEL TUBE MICROPHONE PREAMPLIFIER

Designed as the ideal preamp for any application, the tube driven TPS II adds warmth and texture to any audio source. This two-channel high performance preamp uses a pair of hand selected 12AX7A tubes in the low noise input circuitry. This, coupled with ART's proprietary V3™ (Variable Valve Voicing) and variable input impedance allows the TPS II to deliver incredible performance from cost effective single space rackmount solutions.

**TPSII** .....\$229.00\*



TUBEMPPS



TUBEMPUSB

### SINGLE CHANNEL TUBE PREAMPLIFIER

The ultra low noise discrete microphone preamp front end has an extremely flat and wide frequency response and can easily handle a wide range of input signal levels with a minimum of coloration. The fully adjustable input gain allows as little 'tube warmth' or as much 'tube drive' as required for any audio source.

**TUBEMPPS**.....\$ 89.00B  
**TUBEMPUSB With USB**.....129.00B



### EIGHT CHANNEL MIC SPLITTER

The ART S8 can be used to split eight balanced low impedance microphone signals into sixteen balanced low impedance microphone signals (eight pairs). Each channel of the S8 provides one direct output and one transformer isolated output from a single microphone. Applications include sending the direct outputs to the main or Front-of-House mixer and the second isolated outputs being sent to a monitor or recording mixer. The direct outputs pass phantom power from the main mixer to the microphones for use with condenser microphones.

**S8**.....\$299.00B



### S8 3WAY EIGHT CHANNEL

The S8-3Way eight channel three way microphone splitter is ideal for live sound, fixed install, recording, and broadcast applications where microphone and XLR balanced line level input signals have to go to multiple mix locations. Each channel provides one XLR input, one XLR direct output, with two additional transformer isolated XLR outputs for a total of 3 balanced outputs from each microphone input signal.

**S83WAY**.....\$349.00B



### PRE AMP

The TubeMP is the world's most popular external tube microphone preamp. The TubeMP's TEC award nominated design will allow you to obtain professional recording studio results at a fraction of the cost of comparable equipment. The hybrid design of the Tube MP allows it to add warmth and fatness to a signal while maintaining exceptionally low-noise and high quality. While it's primary application is as a microphone preamp, the TubeMP is an exceptional direct box - impedance matching, amplifying and improving the sound of any instrument plugged into it.

**TUBEMP**.....\$65.00B



### PRE AMP

The TubeMP StudioV3™ offers superior performance and a sound quality any 'on-board' preamps found in today's low-cost mixers and audio interface units aren't capable of delivering. Built with all of the professional input features required in recording or live sound applications, the ART TubeMP StudioV3™ uses a hand-selected 12AX7A tube in the signal path for maximum tone and gain.

**TUBEMPSTV3**.....\$99.00B

\* = CALL FOR DEALER COST

# ART

## APPLIED RESEARCH & TECHNOLOGY



### PHONE PREAMP

The DJ PRE II is a high quality phono preamp designed for your home and studio. It acts as an interface between your turntable and your audio recording system. The analog input capacitance can be switched between 100pf and 200pf to optimize phono cartridge response. A switchable low cut filter removes rumble while leaving the audio pristine.

**DJPRE2**.....\$65.00B



### 4 CHANNEL MIXER

Four channel mixer in the simplest form for any 1/4 inch connection. When you have up to four line-level signal from various sources (ie: mic, instrument, audio samples, etc.) you can expand a console mixer by converting stereo to mono into a single line out.

**SPLITMIX4**.....\$65.00B



**XDIRECT**

**ZDIRECT**

### DIRECT BOXES

High quality interface that allows you to connect your instrument, line, or even speaker level audio signals to any balanced input. Extremely wide, flat frequency response and can handle high input signal levels while still maintaining an isolated, balanced low impedance output.

**XDIRECT Active**.....\$50.00B

**ZDIRECT Passive**.....\$35.00B



### DUAL TRANS ISOLATOR

High quality passive audio interface that uses a pair of high performance transformers to totally separate input and output signals.

**DTI**.....\$75.00B



### FOUR CHANNEL HEADPHONE AMP

The ARTcessories HeadAmp4 is a simple, cost effective solution for any studio requiring up to four additional channels of headphone amplification, each with individual volume control. Ideal for virtually any home or project studio.

**HEADAMP4**.....\$80.00B



### MICROPHONE SPLITTER/COMBINER

The ARTcessories SPLITComPro is an ideal audio utility to use in an application where you need to split a low impedance microphone signal to feed two separate mixers, or where it's necessary to combine balanced low impedance microphone signals from two mics into a single channel input.

**SPLITCOM**.....\$45.00B



### 12V/48V PHANTOM POWER SUPPLY

The Phantom II provides phantom power for one or two condenser microphones. It has a 3-way 12V/OFF/48V selector switch which lets you choose 48V for microphones rated at 24 to 48V, 12V for lower-voltage microphones or "OFF" to conserve battery life. Low-noise operation is featured in all modes and can be used with an optional AC adapter.

**PHANTOMII**.....\$89.00B



### HEADAMP6 PRO

The main outputs for each channel of the headphone amplifier are rear mounted stereo TRS jacks and are wired in parallel with the corresponding output jacks on the front panel. Front panel, rear panel, or both front and rear panel outputs can be used simultaneously to drive headphones or be used as feeds to additional headphone amplifiers in a distributed audio network.

**HAMP6PRO**.....\$249.00B



### TWO CHANNEL DUAL PREAMPLIFIER

It is designed to work over a wide variety of applications from remote field recording to desktop studio tracking. Each of the two low noise input channels has up to 48 dB of clean gain with signal present and clip LED indicators. Inputs can be either XLR balanced or 1/4-inch TRS. Each of the 1/4-inch TRS outputs is buffered low impedance balanced. Flexible 3-way power from USB. External supply, or 9 volt battery. Includes USB cable - everything.

**USBPPS**.....\$99.00B



### USB MIX

The USB Mix is fully USB 2.0 compliant and offers a balanced XLR input or unbalanced 1/4" instrument input with switchable impedance. Switchable low noise 48V phantom power also included. Balanced 1/4" TRS inputs for stereo or mono line-level with 1/4" TRS output jacks that work with either balanced or unbalanced lines. Independent controls are featured for both sets of inputs, main output as well as headphone monitoring. Also featured is a switchable assignment of USB playback and monitoring.

**USBMIX**.....\$89.00B



### A/B-Y SWITCH

The CoolSWITCH delivers full A/B-Y switching, plus parallel common in/out jacks. It lets you switch a common source signal (guitar, bass or keyboard) between two amplifiers or amp channels. It also allows you to switch two source signals (like two different guitars) into the same amplifier.

**COOLSWITCH**.....\$60.00B

**CSPRO Cool Switch Pro**.....\$80.00B



### INTERFACE

The USB Phono Plus V2, acts as an interface between your computer and a wide variety of analog and digital sources. The analog inputs are switchable between Phono and Line level signals and a low cut filter removes rumble and wind noise.

**USBPHONO V2**.....\$129.00B

# PEAVEY® GUITAR ACCESSORIES



## STRINGS

### ELECTRIC GUITAR STRINGS

00579450	Balanced 9s Nickel Wound Elements™ .....	\$7.99
00579470	Balanced 10s Nickel Wound Elements .....	\$7.99
00577930	Balanced 11s Nickel Wound Elements .....	\$7.99
00577940	Balanced 12s Nickel Wound Elements .....	\$7.99
00579480	Balanced 9s Stainless Steel Elements .....	\$8.69
00578130	Balanced 10s Stainless Steel Elements.....	\$8.69

**Peavey Elements include an extra E string at no extra charge.**

### ACOUSTIC GUITAR STRINGS

00578640	Phosphor Bronze-Balanced 12s .....	\$7.99
----------	------------------------------------	--------



### BASS GUITAR STRINGS

Thermal-fused premium bass strings in four, five or six string models.

00379260	Cirrus™ Bass String 4XL .....	\$29.99
00379270	Cirrus Bass String 5XL .....	\$32.49
00379280	Cirrus Bass String 6XL .....	\$43.19



## STRAPS

00070920	Black Nylon Accent Strap .....	\$4.39B
00070930	Blue Nylon Accent Strap .....	\$4.39B
00070940	Red Nylon Accent Strap .....	\$4.39B
00070950	White Nylon Accent Strap.....	\$4.39B
00565890	Premium Black Accent Strap.....	\$14.99B
00565910	Premium Blue Accent Strap.....	\$14.99B
00565900	Premium Red Accent Strap.....	\$14.99B



00394760	Tall Man Strap - Black .....	\$15.79B
00394750	Tall Man Strap - Brown.....	\$15.79B
00710740	2" Black Leather Strap.....	\$10.59B
00710750	3" Black Leather Strap.....	\$11.99B
00456170	2.5" Black Leatherlike Strap.....	\$21.99B
00456180	2.5" Brown Leatherlike Strap.....	\$21.99B
00381950	3" Black Suede Strap .....	\$25.99B
00381940	3" Brown Suede Strap.....	\$25.99B
00381960	3" Tan Suede Strap .....	\$25.99B
00484040	Peavey Black Cushion Strap.....	\$31.99B
00089200	Peavey Black Padded Strap.....	\$11.99B



## TUBES

00070710	EL 84 (2 Per) .....	\$35.99B
00053120	Super 6's (2 Per) .....	\$43.99B
00053150	Super 7's (1 Per) .....	\$19.99B
00053240	Super C's (2 Per) .....	\$51.99B
03004800	Tube Center Wall Display*	

\*Available with qualifying order-contact your sales rep for details.

# PEAVEY® GUITAR ACCESSORIES



## GUITAR ACCESSORIES

### GUITAR ACCESSORIES

00073220	Black Guitar Dome Knobs (pkg. 2)	\$7.59B
00073210	Chrome Guitar Dome Knobs (pkg. 2)	\$7.99B
00073200	Gold Guitar Dome Knobs (pkg. 2)	\$8.59B
00069250	Black Guitar Strap Buttons (pkg. 2)	\$4.39B
00050800	Chrome Guitar Strap Buttons (pkg. 2)	\$4.39B
00069260	Gold Guitar Strap Buttons (pkg. 2)	\$4.79B
00079480	Black Straplock Set	\$15.59B
00079500	Chrome Straplock Set	\$15.59B
00079490	Gold Straplock Set	\$19.39B
00485250	DreamerWinder™ Pegwinder Assortment Jar	\$99.99B
00475710	Glass Slide	\$6.39B
00475720	Steel Slide	\$6.79B
03009010	PT100 Tuner - Recorder	\$29.99B
00050780	Gray Polish Cloth	\$3.59B
03006630	Microfiber Cloth	\$5.59B
03004550	HP's Axe Wax	\$7.99B
03004560	HP's Axe Wax Plus	\$9.99B
00457930	Guitar Polish Kit	\$8.59B

### GUITAR PICKS

00479770	Master Pick Rack	\$439.99B
00479710	TH Black StarTex™ 351 Clam Refill	(Pkg. 12) \$3.99B
00479720	TM Black StarTex 351 Clam Refill	(Pkg. 12) \$3.99B
00479730	MD Black StarTex 351 Clam Refill	(Pkg. 12) \$3.99B
00479740	MH Black StarTex 351 Clam Refill	(Pkg. 12) \$4.19B
00479750	HV Black StarTex 351 Clam Refill	(Pkg. 12) \$4.19B
00479760	XH Black StarTex 351 Clam Refill	(Pkg. 12) \$4.19B
00479580	HV Holographic 351 Clam Refill	(Pkg. 12) \$4.99B
00479470	TH Dreamers™ Red 351 Clam Refill	(Pkg. 12) \$2.79B
00479480	TM Dreamers Orange 351 Clam Refill	(Pkg. 12) \$2.79B
00479490	MD Dreamers Yellow 351 Clam Refill	(Pkg. 12) \$2.79B
00479500	MH Dreamers Green 351 Clam Refill	(Pkg. 12) \$2.99B
00479510	HV Dreamers Blue 351 Clam Refill	(Pkg. 12) \$2.99B
00479520	XH Dreamers Purple 351 Clam Refill	(Pkg. 12) \$2.99B

## JACK DANIEL'S® ACCESSORIES

### JACK DANIEL'S STRAPS

00579670	Jack Daniel's Tennessee Guitar Strap Black	\$7.99B
00579880	Jack Daniel's Tennessee Guitar Strap Brown	\$7.99B
03000520	Jack Daniel's Barrel Stave Black Strap	\$12.99B
03000510	Jack Daniel's Barrel Stave Tan Strap	\$12.99B
03000480	Jack Daniel's Barrelhouse I Strap	\$43.99B
00565400	Jack Daniel's Old No. 7® Black Pin Stripe Strap	\$49.99B
00565410	Jack Daniel's Old No. 7 Brown Pin Stripe Strap	\$49.99B
03000500	Jack Daniel's Square Shooter Strap	\$29.99B
03000490	Jack Daniel's Filigree White Oak Strap	\$45.99B
03000470	Jack Daniel's Old No. 7 Black Label Strap	\$45.99B
00568250	Jack Daniel's Tennessee Whiskey Black Strap	\$59.99B

### JACK DANIEL'S STRINGS

00590680	Jack Daniel's Lynchburg Premium Phosphor Bronze Acoustic 10s	\$13.99
00590560	Jack Daniel's Lynchburg Premium Phosphor Bronze Acoustic 11s	\$13.99
00590570	Jack Daniel's Lynchburg Premium Phosphor Bronze Acoustic 12s	\$13.99
00590540	Jack Daniel's Nickel Wound Premium Electric 9s	\$12.99
00590550	Jack Daniel's Nickel Wound Premium Electric 10s	\$12.99

### JACK DANIEL'S PICKS

00579610	Jack Daniel's Pick Kit	\$99.99B
00579620	Jack Daniel's 72PC Refill	\$25.99B
00580140	TH 351 Jack Daniel's Clam Black Pearl (pkg. 12)	\$9.99B
00580150	MD 351 Jack Daniel's Clam Black Pearl (pkg. 12)	\$9.99B
00580160	HV 351 Jack Daniel's Clam Black Pearl (pkg. 12)	\$9.99B
00579580	TH 351 Jack Daniel's Clam White Pearl (pkg. 12)	\$9.99B
00579590	MD 351 Jack Daniel's Clam White Pearl (pkg. 12)	\$9.99B
00579600	HV 351 Jack Daniel's Clam White Pearl (pkg. 12)	\$9.99B
00580470	TH 351 Jack Daniel's Clam Black Matte (pkg. 12)	\$9.99B
00580480	MD 351 Jack Daniel's Clam Black Matte (pkg. 12)	\$9.99B
00580490	HV 351 Jack Daniel's Clam Black Matte (pkg. 12)	\$9.99B
03004670	Jack Daniel's Accessory Wall Display*	

\*Available with qualifying order-contact your sales rep for details.

# PEAVEY MICROPHONES

## PV<sup>®</sup>i 100 MICROPHONE

- Dynamic cardioid vocal microphone designed for stand-mount application
- Package Includes PVi 100, carrying pouch, mic clip and 6 meter mic cable
- Available with XLR to XLR or XLR to 1/4" cable
- POP clam shell packaging



00577800 PV<sup>®</sup>i 100 Microphone - XLR w/ clam shell.....\$29.99  
 00577810 PV i 100 Microphone - 1/4" w/ clam shell.....\$29.99

## PV<sup>®</sup>i 2i MICROPHONE

- Package includes PVi 2 dynamic cardioid microphone, 6 meter microphone cable, mic clip, and carrying pouch
- Finish options - black, gold or white
- Available with XLR to XLR or XLR to 1/4" cable



00496570 PV i 2 Microphone - 1/4" cable.....\$59.99  
 00496360 PV i 2 Microphone - XLR cable.....\$59.99  
 00593440 PV i 2W Microphone - XLR cable.....\$84.99  
 00593500 PV i 2W Microphone - 1/4" cable.....\$84.99  
 00593430 PV i 2G Microphone - XLR cable.....\$84.99  
 00593490 PV i 2G Microphone - 1/4" cable.....\$84.99

## PV<sup>®</sup>i 3 MICROPHONE

- Super-cardioid dynamic vocal microphone package include PVi 3 microphone, 6 meter XLR to XLR microphone cable, mic clip, and carrying pouch
- Features specially designed rubber ring around a hardened mesh grill to guard against damage from impact
- Extended high-frequency response covers a wide range of the frequency spectrum
- POP clam shell packaging



03569810 PV i 3 Microphone - XLR cable .....\$69.99

## PV<sup>®</sup> 7 MICROPHONE

- Dynamic cardioid microphone designed for vocal application
- Ideal karaoke microphone
- Includes either XLR to XLR or XLR to 1/4" microphone cable

03013490 PV<sup>®</sup>7 Microphone - XLR .....\$24.99  
 00597360 PV<sup>®</sup>7 Microphone - 1/4".....\$24.99

## PVM<sup>®</sup> 45i<sup>r</sup> MICROPHONE

- Super cardioid dynamic instrument microphone
- Neodymium magnet
- Package includes PVM 45i<sup>r</sup> and 6 meter XLR to XLR mic cable



00593450 PVM<sup>™</sup> 45i<sup>r</sup>.....\$129.99

## H-5<sup>™</sup> AND H-5C<sup>™</sup> MICROPHONES

- Expressive, responsive omni-directional dynamic harmonica microphone
- Contoured black housing with finger placement grooves and brushed aluminum grille
- Center-detent volume control
- Includes detachable mini-XLR to 1/4" mic cable
- On/off switch
- Carrying case included



00563080 H-5C<sup>™</sup> Cherry Bomb<sup>™</sup> Red w/ Black Grill.....\$179.99  
 00597360 H-5<sup>™</sup> Harmonica Mic, Black w/ Aluminum Grill.....\$179.99

## STUDIO PRO<sup>®</sup> CM1 MICROPHONE

- Cardioid condenser hand held microphone
- Medium format element
- Ideal for vocal or instrumental pickup
- Mic incorporates dual-layer pop filter



00576730 Studio Pro<sup>®</sup> CM1 .....\$199.99

## VCM<sup>®</sup> CHOIR MICROPHONE

- Miniature, cardioid pattern, electret condenser choir microphone
- 9-52 Volt phantom power
- Designed to be suspended over choirs, instrumental ensembles, or stage areas for sound reinforcement and recording applications
- Available in black or white finish



00577970 VCM<sup>™</sup> 3 Choir Microphone - Black.....\$199.99  
 00577960 VCM 3 Choir Microphone - White.....\$199.99



## PVM<sup>®</sup> DMS-5 DRUM MIC SYSTEM

- A complete drum microphone system all in one package
- Package includes one PVM<sup>™</sup> 321 Kick Drum, One PVM 325 snare mic, three PVM 328 tom mics, four drum mount clips, four mic cables with 90 degree XLR connectors, one mic cable with straight XLR connectors and carrying case

00493130 PVM<sup>™</sup> DMS-5 Drum Mic System .....\$499.99



## PV<sup>®</sup> MSP1 MICROPHONE PACKAGING

- Complete microphone/microphone stand package
- Includes PVi 100 dynamic cardioid mic, tripod mic stand with boom, 6 meter mic cable, mic clip, mic carrying pouch, and convenient zippered nylon carry bag
- Available with XLR to XLR or XLR to 1/4" cable
- POP packaging

00578000 PV<sup>®</sup> MSP1 Microphone XLR/Mic Stand Package .....\$59.99  
 00579890 PV MSP1 Microphone 1/4" /Mic Stand Package .....\$59.99



## 6 SPACE AND 12 SPACE MIC BAGS

- Padded 6 space and 12 space mic bags with accessory pouch
- Includes Peavy logo luggage tag for easy identification

03011860 6 Space Mic Bag .....\$39.99B  
 03011870 12 Space Mic Bag .....\$49.99B



# PEAVEY® ACCESSORIES



## MOLDED PATCH CABLES

00054550	1' Color Coded Patch Cables (6)	\$17.69
00054570	3' Color Coded Patch Cables (6)	\$22.49
00069580	4" RA/RA Molded Patch Cables (6)	\$17.99



## CABLES

00576010	PV® 5' Instrument Cable	\$9.89
00576020	PV 10' Instrument Cable	\$11.99
00576030	PV 15' Instrument Cable	\$14.94
00576040	PV 20' Instrument Cable	\$17.39
00578860	PV 10' Multi-Color Instrument	\$17.99
00578870	PV 15' Multi-Color Instrument	\$21.89
00578880	PV 20' Multi-Color Instrument	\$25.49
00576220	PV 10' Low Z Mic Cable	\$16.79
00576230	PV 20' Low Z Mic Cable	\$20.69
00576270	PV 10' High Z Mic Cable	\$13.19
00576280	PV 20' High Z Mic Cable	\$17.99
00576210	PV 5' Low Z Mic Cable	\$14.99
00576240	PV 25' Low Z Mic Cable	\$22.49
00576070	PV 25' 18 Gauge S/S Speaker Cable	\$14.99
00576080	PV 25' 16 Gauge S/S Speaker Cable	\$20.39
00576090	PV 50' 16 Gauge S/S Speaker Cable	\$32.39
00576100	PV 25' 14 Gauge S/S Speaker Cable	\$26.39
00576110	PV 50' 14 Gauge S/S Speaker Cable	\$44.99
00576120	PV 25' 12 Gauge S/S Speaker Cable	\$40.49

**Limited lifetime warranty.**



## BATTERIES

00497010	AA BATTERIES 4 PK	\$3.59B
00050130	BATTERY,9V,SINGLE PACK	\$3.59B
00578740	BATTERY DISPLAY*	

*\*Available with qualifying order-contact your sales rep for details.*



## CONNECTORS

00496030	2-Pole Neutrik® Female Cable Mount Speakon® Connector NL2FC	\$6.79B
00495520	4-Pole Neutrik Female Cable Mount Speakon Connector NL4FX	\$8.39B
00384820	NA4LJX - Neutrik Speakon to 1/4" Adapter	\$12.99B

# PEAVEY® ACCESSORIES



## BAGS & CASES

00479950	Electric Guitar Bag.....	\$25.99
00480400	Deluxe Acoustic Bag.....	\$37.49
00454110	Acoustic Lite Case.....	\$99.99
00454120	Electric Lite Case.....	\$101.29
00496970	Bass Lite Case.....	\$109.99
00385160	Speaker Stand Bag.....	\$44.99



## HARDWARE

00051600	Small Rubber Feet (pkg. 4).....	\$4.99B
00051610	Large Rubber Feet (pkg. 4).....	\$5.99B
03006950	2" Hard Rubber Caster.....	\$8.39B
00051300	Metal Glide Feet (pkg. 4).....	\$5.39B
00576000	Metal Recessed Handle.....	\$14.79B
00052590	Black with Black Retainer Strap Handle.....	\$5.99B
00051700	Black with Chrome Retainer Strap Handle.....	\$5.99B
00051220	Pop Out Caster Set.....	\$25.99B



## STANDS

00370800	Black Boom Arm.....	\$24.99
00723350	Black Round Base Mic Stand.....	\$35.42
00051540	V-Base Microphone Stand priced and shipped in pairs...	\$87.49
00722910	Tripod Mic Stand with Boom Arm.....	\$64.99
00394500	Table Top Mic Stand.....	\$16.29
00722880	Combo Amp Stand.....	\$72.49
03007580	Black Speaker Stand.....	\$99.99
00124170	Versamount™ 35 Black.....	\$54.99
00477970	Versamount 35 White.....	\$54.99
03011050	Versamount 70 Plus-Black.....	\$124.99
03011040	Versamount 70 Plus-White.....	\$124.99

### VERSAMOUNT™ 35

- Ceiling bracket can be used with the Peavey Impulse® 6, Impulse 6T, Impulse 652S, Impulse 7, SSE™-26 and Impulse 100 cabinets
- Supports up to 35 lbs.

### VERSAMOUNT 70 PLUS

- Mounting bracket can be used with the Peavey Stadia™ II, Stadia IIT, Impulse® 200/1012/PR®12, Impulse 500/1015/PR15, Impulse 100/PR10, SSE 15, SSE 12, and SSE 10 cabinets
- Supports up to 70 lbs.
- Designed as a ceiling or wall-mount bracket

**Direct Interface Boxes**  
**Professional and portable—multiple units fit in one rack space.**



**PDI Passive Direct Interface**

03001340 PDI (Passive Direct Interface).....\$99.99B

- The PDI is a classic Passive Direct Interface box
- The transformer used in the PDI is the reason for its outstanding performance
- The PDI provides the high input impedance, ground isolation and signal attenuation needed to connect a variety of instruments to a mixer mic input
- Quality transformer with faraday shield
- Instrument input and thru
- Stereo input for electronic instruments
- Balanced mono output
- Ground lift switch
- Mono/Stereo input selector



**HB2 Headphone Amplifier**

18025180 HB-2 (Headphone Amp) w/ Power Supply.....\$121.99B

- The HB-2 is a versatile headphone amplifier with applications both on and off stage
- After the gig, the HB-2 makes a compact practice amplifier
- Up to 4 pairs of stereo headphones with a 32-Ohm or greater rating can be connected to the HB-2 using the appropriate headphone Y-cord splitters
- Mono instrument input
- 1/4" and 1/8"(3.5mm) stereo inputs
- Stereo or mono operation
- Powerful headphone output
- Adjustable limiter for hearing protection
- 1/4" thru for linking multiple units
- 15 VDC input



**KOSMOS®-M Subharmonic Bass Processor**

18025250 Kosmos M w/ Power Supply.....\$105.99B

- The sub-harmonic generator in the Kosmos processor enhances the sound of instruments by generating a copy of the signals in their bass range but shifted an octave lower
- Kosmos M places this circuitry in a phantom powered processor that can be connected in line between a dynamic microphone and the mix console
- The mic input on the Kosmos M is designed for high volume applications so a pad is not required
- Kosmos sub-harmonic generation technology with damping selector switch
- XLR mic input
- Phantom power or 15 VDC input (option)



**USB-P USB Audio Device**

03001370 USB-P (USB Audio Interface w/ Transformer).....\$79.99B

- The USB-P is a USB audio device with transformer isolated balanced stereo outputs for connecting a computer to a sound system
- As the name implies, the USB-P connects to the USB port of the computer and appears as a stereo output device
- The dual transformers in the USB-P provide balanced outputs and ground isolation required when interfacing a computer to a sound system
- Standard USB class compliant audio device
- No special drivers required
- Transformer isolation
- Ground lifted balanced outputs
- Playback only
- USB powered
- Stereo/Mono output switch

# PEAVEY PORTABLE P.A.

## Escort® 3000

### Convenient, all-in-one P.A. system with wheels.

300 Watts (150 x 2) • Two-way speaker system with 10" woofer • 7 channels • Custom rubberized knobs • 6 combination XLR 1/4" inputs • RCA/3.5 TRS media inputs • USB MP3 playback • Patented FLS® (Feedback locating system) • Digital multi-effects • Mid-morph® • LCD screen for ease of file playback and effect selection • Seven-band graphic equalizer • Two folding speaker stands • Two 15' speaker cables • Storage compartment for optional accessories • Convenient package with luggage-style wheels.

03608880 ESCORT 3000 W/O STAND – IMP-120V .....\$999.99B  
 00496340 Escort Stand .....59.99B



## Escort® 5000

### Convenient, all-in-one P.A. system with wheels.

500 Watts (250 x 2) • Two-way speaker system with 10" woofer • 8 channels • Custom rubberized knobs • 7 combination XLR 1/4" inputs • RCA/3.5 TRS media inputs • USB MP3 playback • Patented FLS® (Feedback locating system) • Digital multi-effects • Mid-morph® • LCD screen for ease of file playback and effect selection • Seven-band graphic equalizer • Monitor send • Subwoofer output • Two folding speaker stands • Two 15' speaker cables.

The carrying case provides storage for everything needed for sound, including plenty of room for optional accessories such as microphones and cables. In addition to the included folding speaker stand, the case even includes luggage style wheels to roll the entire system away. No heavy lifting, just heavy audio!

03608930 ESCORT 5000 W/O STAND .....\$1199.99B  
 00496340 Escort Stand .....59.99B



#### FLS® Feedback Locating System

Feedback is a potential problem with any room and any sound system, but our patented Feedback Locating System helps you locate and stop the offending frequencies with great precision. At the onset of feedback, an LED will glow above the problematic frequency band. All you have to do is bring down that fader until the LED fades, or the feedback stops. By knowing exactly which frequency band to cut, you can avoid cutting useful audio that is not contributing to the feedback.

# PEAVEY PORTABLE P.A.

## Messenger®

At 24" wide and just 24 lbs., the Messenger® is completely self contained and sets up in seconds. The Messenger features a robust five-channel mixer with FLS® Feedback Locating System and a 100-watt output that makes it ideal for an endless array of applications, from open-mic performances to presentations and meetings to karaoke.

00573540 Messenger .....\$499.99B  
 00590200 Messenger Speaker Stands.....\$49.99B

### Split Track Mix™



As featured on the Peavey Messenger portable audio system, Split-Track Mix allows you to adjust the volume of vocals and backing tracks on split-accompaniment recordings, so you can have as much or as little of the original vocals in the mix as you want. Great for churches and karaoke!



**Karaoke**

**Conferences**

**Presentations**



**A complete, portable sound system as convenient as a briefcase.**

# FURMAN SOUND

## POWER CONDITIONER



Linear Filtering Technology (LiFT) • Series mode protection plus (SMP+) • Automatic Extreme Voltage Shutdown (E.V.S.) • LED rack lights provide long-life, low heat illumination for front of the rack • Zero ground contamination circuitry assures the delivery of pure AC • Rear BNC connector for optional gooseneck light to illuminate rear of the rack. • 15 Amp/1800 watt rating, with circuit breaker.

- PL8C .....\$240.00B
- PLPLUSC With Slide Out Lights .....\$299.00B
- PLBULB .....5.00B
- PLPRODMC 20 Amp/2400 watt rating .....550.00B

## MERIT SERIES POWER CONDITIONER



Filters noise from radio frequencies and electromagnetic interference • Standard level of surge suppression • 8 rear panel outlets • Sturdy one rack space design • 15 Amp capacity with circuit breaker

- M8X2 .....\$90.00B
- M8LX with Lights .....130.00B
- M8DX with LED meter .....180.00B

## POWER SEQUENCER



120 AMP SEQUENCER W/REMOTE TURN ON/OFF  
120 amp distro • 6 x 20 amp • 3 phase ready (+ phase check) • 6 channel sequencing w/remote capability • Front panel key switch for security.

- ASD120 .....\$899.00B

## VOLTAGE REGULATOR



Delivers a stable 120±5VAC whenever the input AC line voltage is between 97V and 141V. Eight outlets on the back panel, one on the front. Output capacity 15 amps. Eight-tap toroidal autoformer with low stray magnetic field leakage. 10-LED bargraph Input Voltage meter.

- AR1215 .....\$699.00B

## POWER CONDITIONER WITH SEQUENCING



The perfect low-cost AC power solution for any rack mount system is the Furman Merit M8S Power Conditioner with Sequencing. Install an M-8S in to the top slot of your rack, and the eight switched outlets in the rear panel will power up and protect all your equipment up to a 15-amp load.

- M8S.....\$299.00B

## SMART SEQUENCER™



Providing robust control options, the CN-2400S (20 amp) supports RS-232 communication with command sets for integration with control systems. An optional RS-232-to-Ethernet adaptor (sold separately) adds full IP-addressability to the unit, allowing it to be controlled, programmed, and monitored from a smartphone, tablet, PC, remote power and energy management platform.

- CN2400S .....\$611.10B
- ADP1520 Adapter Cord .....29.95B

## PRO PLUGS



### SURGE SUPPRESSORS

- SS6B 6-Outlet Block .....\$50.00B

## BALANCED POWER



Provides precisely balanced 120V AC power by creating equal and opposite 60V legs, analogous to balanced audio. Back panel features 12 isolated, balanced outlets; front has two more, plus a three-color, 20 LED "smart" voltmeter. Soft Start circuit prevents excessive inrush currents.

- IT1220 .....\$2149.00B

## AC OUTLET



The Furman M-10 10 AC Outlet is a power distributor with a sturdy rack-mount design and 10 available outlets. A convenient way to power a rack of equipment up to a 154 amp load.

- D10PPF .....\$60.00B

## PLUGLOCK STRIP



Has outlets spaced widely enough for five bulky transformer "wall warts". Has clamps to securely lock wall warts into place. Can lock regular plugs as well as wall warts.

- PLUGLOCK .....\$60.00B

## HEADPHONE SYSTEM



Perfect for use as a headphone system in the studio, plus drives powered monitors in live sound applications. Provides each musician with five volume controls: four monaural (for mixer channels or busses), plus one for an overall stereo mix or a stereo effects return.

- HR2 Remote Station .....\$125.00B
- HR6 Mixing Station.....179.00B

## POWER FACTOR



Engineered specifically for use with instrument amplifiers and other high-current equipment, the Furman P-1800 PF R offers a stable, protected and filtered low impedance powered supply for maximum performance of connected electronics. Furman's exclusive Power Factor provides a 45A peak current reservoir to minimize the detrimental effects of line impedance on high-current gear such as amplifiers and powered monitors. Clear Tone Technology provides additional line noise filtration tuned for instrument amplifiers for clean and consistent tone. Plus, equipment benefits from professional-level protection thanks for Furman's exclusive SMP and EVS technologies.

- P1800PFR .....\$750.00B

## EBTECH®



### HUM ELIMINATOR

Eliminates hum and buzz caused by ground loop or unbalanced cable connects. Available in 2 channel box or 8 channel single rack space.

**HE2** (2 Channel) .....\$138.00  
**HE8** (8 Channel) .....\$458.00



### HUM ELIMINATOR

New 2 channel hand held box with 1/4" and XLR.

**HE2XLR** (2 Channel) .....\$178.00



### HUM X

Exterminates ground loop hum at the source! Filters ground line of hum while simultaneously maintaining safe ground.

**HUMX** .....\$150.00



### LINE LEVEL SHIFTER

Increase/Decrease signal voltage between -10dBV and +dBu. Converts back and forth between balanced and unbalanced cable types. Eliminates ground loop too.

**LLS2** (2 Channel) .....\$158.00



### LINE LEVEL SHIFTER

New 2 channel hand held box with 1/4" and XLR.

**LLS2XLR** (2 Channel) .....\$200.00



### MORLEY

Effects Loop Corrector corrects the variations in FX Leaps signals that exist from amp to amp.

**ELC** .....\$156.00

## SEIKO TUNERS



### GUITAR & BASS TUNER

Selectable Auto-tuning, Manual-tuning, and Sound Modes • Wide, Modern tuning range: Tunes Low B strings on Guitar and Bass • Very wide range of reference tones (from Bass LowB, to one octave above guitar's HiE).

**SAT101BK** .....\$27.99  
**SSAT10BK** w/Flat Function .....\$26.99  
**SSAT10B** w/Flat Function .....\$26.99

### CLIP-ON TUNER METRONOME

The World's first hybrid clip-on tuner/metronome. Highly accurate chromatic tuner. Multi-function metronome. Clips on any instrument for easy access.

**SSTMX1** .....\$99.99  
**SSTX5** Chromatic Tuner .....\$29.99B



### CHROMATIC TUNER, SOUND REFERENCE

Its high contrast LCD display offers great visibility and its dynamic speaker makes clear, loud reference tones. Having user friendly buttons, offers an easy and fast tuning experience and a built-in microphone for acoustic instruments is included and its key transpose mode (C, Eb, F, Bb) is useful for brass players. Comes with two AAA batteries and an input and output-jack.

**SAT50WE** .....\$29.95

### UKULELE TUNERS

New tuner dedicated for Ukulele (String number indicator on LED display). 2 buttons (Power and Pitch adjustment button). Adjustable angle for viewing.

**SSTX5UCE** Brown .....\$29.99B  
**SSTX5UWE** White .....\$29.99B

### CLIP ON CHROMATIC TUNER

The world's first rechargeable clip-on tuner with a flashlight. Rechargeable via USB! Includes a built-in rechargeable lithium-ion battery, manufactured in-house. Full charges in just 3 hours and no need for replacement batteries. Bright white LED flashlight. Helps you read music in the dark or when setting up the stage. Adjustable brightness (Low/High).

**SSTX7** .....\$59.99B

## CHERUB TUNERS



### CHROMATIC TUNER

With a frequency reading of Db2 (69.3hz) to D6 (1174.7hz). It's a very versatile tuner that can even read 5 and 6 string basses. Features include Chromatic pitch output, auto mode, and manual mode. Available in Silver.

**WST500A** .....\$21.95



### VIOLIN/MANDOLIN

Only two control switches: one for power, one for semitone tuning!

**WST550VM** .....\$21.95  
**WST550C** Chromatic .....\$24.95  
**WST550U** Soprano Ukulele .....\$21.95



### CHROMATIC TUNER

An auto-chromatic tuner designed for guitar and bass. Reads frequencies from E1 (41hz) to A6 (1760hz). Lightweight, compact and easy to use. Available in Silver.

**WST520C** .....\$18.80



### GUITAR/BASS TUNER

A tuner designed for guitar and bass, and can be used to tune a half-step down. Reads frequencies from E1 (41hz) to A6 (1760hz). Separate function for normal tuning and flat-tuning. Portable and easy to use. Available in Dark Grey.

**WST520GB** .....\$16.80



### GUITAR MATE

Works by sensing vibrations, allowing accurate tuning regardless of ambient noise. Features a "flat-switch" for accurate tuning a semitone down. Automatically displays string number and name of note. Easy-to-read LED's. Auto-off conserves battery life. 2032 battery included. "Battery tray" makes changing batteries a breeze.

**WST550G** .....\$21.95  
**HFGT6** HFI .....\$15.75



### CLIP STYLE, AUTO TUNER

Designed for Guitar, Bass, Wind Instruments, Violin and Ukulele • Tuning Range A0 (27.5Hz)-A3 (1760Hz) • Auto-Chromatic Tuning.

**WST523** .....\$24.95

# KORG TUNERS



## PITCHBLACK CHROMATIC PEDAL TUNER

100% true bypass output keeps your tone intact. Choose from four types of display modes: Full Strobe, Half Strobe, Meter & Mirror. Compact pedal sized guitar/bass tuner that fits in your pedal board. Large bright LED meters clearly show any tuning discrepancy. A broad detection range from E0 (20.60 Hz) to C8 (4186 Hz). Calibration is adjustable from 436-445 Hz. A 9 VDC output jack is provided for cascading the power supply to other pedals.

**PB01** Pitchblack .....\$69.99\*



## KORG PC1 PITCHCLIP CLIP-ON CHROMATIC TUNER

This Korg P1 Pitchclip Clip-on Chromatic Tuner is a simple, convenient clip-on style chromatic tuner with a compact, lightweight, and discreet design. The clear, bright, and easy-to-read LED display reverses to assure easy viewing when mounted on either side of the headstock.

**KPC1** Pitchclip .....\$19.99



## HEADTUNE CLIP ON TUNERS

The headtune is a clip-on tuner with a unique design that's based on the shape of a guitar, bass or ukulele headstock. With the headtune attached to the headstock of your instrument, play a single note on the string that you want to tune. Two indicators will illuminate: the string indicator LED will show you the peg position, and the LED meter will indicate the tuning of that note. This makes it obvious which peg needs to be adjusted.

**KHTG1** 6 In Line Guitar .....\$29.99  
**KHTG2** 3+3 Guitar .....\$29.99  
**KHTB1** Bass Guitar .....\$29.99  
**KHTU1** Ukulele .....\$29.99



## PITCHHAWK CLIP ON TUNERS

The high precision and sensitivity that you expect from Korg. New type of clip provides a firm hold. Movable arm with ball joint that allows free adjustment of the angle. New type of display providing superb visibility that's both bright and readable from any angle. High durability that stands up to impact and aging. Folds up compactly for easy transport. Easy-to-understand operation, with buttons placed on the front. The Auto Power-off function saves the battery even if you forget to turn off the unit. Memory backup function.

**KAW3GBK** Guitar and Bass .....\$39.99  
**KAW3U** Ukuleles, Large and Small .....\$29.99

## DOLCETTO CLIP-ON TUNER/METRONOME

**KAW3M** Large or Small Orchestra Tuning ..\$39.99\*  
**KAW3T** Trumpet or Trombone Tuning .....\$39.99\*  
**KAW3V** Violin or Viola Tuning .....\$39.99\*



## KORG MICROMETRO DIGITAL METRONOME

The metronome volume can be set to Loud or Soft – or even muted – to suit different environments. The current tempo is also indicated by the flashing LED. This combination of visual and audible cues makes it easy to follow the tempo. For discrete use, the sound may be muted completely, providing a visual-only tempo indicator. The current tempo and beat pattern are retained even when the power is off, allowing you to quickly recall your favorite settings. W/clip.

(B) Blue, (R) Red

**KMCM1** .....\$14.99B



## PITCHBLACK PORTABLE POLYPHONIC TUNER

The pitchblack Portable is a guitar/bass polyphonic tuner that provides speedy and accurate tuning. The pitchblack Portable features a high-brightness LED display which provides excellent visibility. Korg's proprietary cable checker function is also built-in, letting you easily check for broken cables. Rapid and precise polyphonic tuning, with the tuning of all strings visible at a glance. String seeker function. Three meter display modes: regular, strobe, and half-strobe. Ideal for 'floating tremelo systems.' Korg's proprietary automatic guitar/bass (4-6 string) detection. Flat (5 Semitones), Capo (7 Semitones), and Drop-D tunings are also supported.

**PB04** .....\$180.00  
 Black (BK), Red (R), Silver (SI)



## PITCHBLACK POLYPHONIC PEDAL TUNER

A single strum checks all six strings. String Seeker detects the active string. Auto-detects guitars and up to 6-string basses. True Bypass preserves tonal clarity. Battery/optional AC operation. Save time and money while tuning! Ideal for floating tremelo systems. Meter, Full Strobe, Half Strobe, Split modes. Flat (down 5); Capo (up 7); Drop D tunings. Rugged diecast body. 9 Volt cascade power output.

**PB03** Pitchblack Polyphonic Pedal Tuner .....\$89.99B



The MA-1 is a compact metronome that solidly covers all the basics with a broad tempo range and a rich variety of beats and rhythm patterns. The MA-1 also shows the beat in an innovative way that makes practicing easier.

**KMA1** Metronome .....\$21.99  
 Specify (B) Blue, (R) Red

• = CALL FOR DEALER COST  
[www.korg.com](http://www.korg.com)



## BEATBOY DRUM MACHINE / RECORDER / TUNER

Perform backed by 100 full-fledged rhythm patterns. Use the tap tempo feature to adjust the tempo intuitively, or use the tempo adjustment buttons to make fine adjustments. Adjust the volume of the drum machine to fine tune the mix balance with your guitar sound. Tuner function ensures that your pitch is accurate. Overdrive/distortion effect for electric guitar. Recorder allows 16-bit/44.1 kHz PCM recording and playback. Approximately 20 minutes of recording, with a maximum of 100 tracks. USB port allows your recorded phrases to be easily backed-up to your computer. Internal mic supports acoustic instruments. Built-in speaker lets you immediately listen back to recorded sounds.

**KBB** .....\$89.99



# KORG TUNERS



Ultra-compact design. • High-precision LCD needle-type meter for stable tuning. • Quinta Flat Tuning mode lets you tune 1-5 semitones flat. • Supports 7-string guitar tunings. • Sound Out can produce a reference tone from the internal speaker.

**KGA1** Guitar, Bass .....\$16.99

## RIMPITCH ACOUSTIC GUITAR TUNER

**KRPG1** Sound Hole .....\$24.99B



Compact chromatic tuner, ideal for brass band or orchestra. • High-precision LCD needle-type meter for stable tuning. • Wide range of pitch detection covers C1–C8. • Calibration function supports a variety of concert pitches. • Sound Out produces a reference tone from the internal speaker.

**KCA1** Chromatic .....\$19.99



The OT-120 is the newest model in Korg's lineup of tuners whose precision and functionality has made them the choice of musicians around the world. The OT-120 features a dual display with both a VU-style meter for accurate pitch indication and an LCD screen for excellent visibility.

**KOT120** .....\$150.00

**KCM200** Mic.....\$14.99B  
(BK) Black, (R) Red, (W) White



## TUNER METRONOME RECORDER

Tuner, metronome and recorder can be used simultaneously or independently. Internal mic and speaker make it easy to record and play back your performance. Loop play function lets you repeat a desired region of a recorded track. High quality linear PCM recording/playback. Record up to 100 tracks (approximately total 20 minutes). USB port lets you transfer recorded data and song files between the TMR-50 and your computer.

**KTMR50**.....\$110.00B

(BK) Black, (PW) Pearl White



Tune orchestra instruments in their original keys (Eb, Bb, F and C) without transposing. Use the built-in mic or piezo sensor. 3-Mode backlit display; Soft, Auto/Bright, Unlit. Small and large clips fit any instrument. Double ball-joint mount for easy placement. Reversible display for improved viewing.

**AW2PLUS** Clip-On Tuner .....\$57.60



With a large note name display in the center and red LEDs that rotate in a circular pattern, it is a revolutionary tuner with superb visibility.

**KGT4** .....\$70.00



Built-in A440Hz reference tone generator • Loud click sound allowing wide range of rhythm training applications. • Adjustable click volume level that can be defeated to use only flashing LED for rhythm training. • Earphone jack.

**KDM2** Digital Metronome .....\$59.99B



An ultra-compact, ultra-lightweight chromatic tuner you can attach to your wind or string instrument for easy and accurate tuning.

Piezo pickup detects vibrations from the attached instrument, or the built-in microphone detects the pitch • Marks to indicate pure major third and minor third intervals. (W) White.

**AW2W** White – Orchestra Tuning .....\$75.00

**AW2GW** Guitar/Bass .....75.00

**AW2U** Ukulele .....65.00



Convenient metronome/tuner combo offers portability and convenience. Easy to read adjustable backlight LCD screen w/LED sharp/flat indicators. Wide range (C1-C5) chromatic tuner, ideal for band & orchestra instruments or guitar and bass. Sound back feature. Reference tone supports a range of three octaves. Metronome features 30-252 BPM. Dedicated tap tempo button with an LED that blinks in time with temp.

**KTM50** .....\$29.99B

(BK) Black, (PW) Pearl White



Chromatic auto-tuner for all types of instruments. • Ultra large LCD screen provides excellent visibility. • Equipped with Output jack. • Adjustable calibration range (410-480Hz). • Pure major/minor 3rd pitch indication marks. • Built-in Reference tone, Microphone, Speaker & folding stand. • Auto Power off and memory back up, batteries included.

**KCA40** .....\$21.99

**KHA40** Hawaiian .....\$35.00



Guitar & Bass auto-tuner. • Ultra large LCD screen provides excellent visibility. • Equipped with Output jack. • Tunes 6 & 7 string guitars and 4, 5 & 6 string basses. • “Quinta” flat tuning lets you tune down as much as five semitones. • Built-in Reference tone, Microphone, Speaker & folding stand. • Auto Power off and memory back up, batteries included.

**KGA40** .....\$18.99B

**KBA40** Bluegrass .....\$21.99B



## PITCH JACK

Plug directly into the input jack of your instrument Tune guitar up to 7 strings and bass up to 6 strings. Flat tuning – down to 7 semitones.

Specify (BK) Black, (W) White, (R) Red  
**GBI** .....\$30.00

## SONUUS

### GUITAR MIDI



A true plug-and-play solution for monophonic MIDI guitar designed to give accurate triggering with low latency. It can be used to sequence bass lines and guitar solos and add an edge to your live performances – it opens up many creative possibilities.

Any electric guitar can be used as a solo MIDI guitar. No guitar modifications or special pickups required. Robust note detection – minimizes wrong notes. Low latency. Built-in tuner for standard guitar tuning. Battery-powered with long battery life. Compact, lightweight and portable.

**G2M** .....\$129.00B  
**B2M** Bass.....129.00B

## PETERSON TUNERS



### PRO INPUT EXPANDER

Active Mutable DI with Input Patch • Mono, Stereo • Balanced In and Outputs • Foot Switchable Presets.

**SREX** .....\$125.00\*



### STROBO RACK

Unlimited presets • Mute • Virtual Strobe Technology • BNC Light Jack on rear panel.

**VSR** .....\$599.00B

### STROBOPUS HD™

The Peterson StrobePlus HD™ is an ultra high-resolution strobe tuner with our largest illuminated display ever featured in a traditional strobe format. Chromatically tune any instrument confidently to the exacting standards or use any of the over 90 exclusive Sweetened Tunings™ that are developed and optimized for your specific instrument. Use the built-in mic, plug in or use a clip-on pickup to tune your instruments quickly with its smooth, real-time display or program your custom tunings using our PetersonConnect™ online utility.

**PSP1** .....\$189.99



### STROBO CLIP

The StrobeClip™ has the 1/10 cent accuracy of all Peterson strobes and also includes new Sweetened™ Tunings and alternate temperaments for a wide variety of string and wind instruments. With carrying case.

**PESC1** .....\$99.99B

\* = CALL FOR DEALER COST

## PETERSON TUNERS



### AUTOSTROBE

+2/-1 display features the strobe pattern into the more visible middle range – bass note patterns can be displayed 2 octaves higher and treble note patterns can be displayed 1 octave lower in the strobe display.

**490** .....\$1099.00B

**R490** Rack mountable .....1139.00B

**PETP3** Tuning Mic .....16.95

Stretch (curve) tuning capabilities. Comprehensive assortment of preset stretch tables for various pianos. Memory for up to 31 programmable stretch tables.

**490ST** .....\$1350.00B



### STROBO STOMP CLASSIC

Unparalleled note detection and a high definition real-time strobe display resolution of 0.1 cent combined with a host of presets allowing for each instrument's individual idiosyncrasies.

**VSSC** .....\$315.00B

## MATRIX TUNERS



### AUTO CHROMATIC

Quartz accuracy • Built-in microphone • Super compact design • Easy to read LED readout • Uses 2 AAA batteries.

**SR1050** .....\$17.99B



### METER DISPLAY

Guitar & Bass; Quartz accuracy • Large easy to read METER • In & Out jacks for in-line tuning • Built-in microphone • Uses conventional 9V battery • Attractive compace design.

**SR1000** .....\$24.99B



### AUTO CHROMATIC

Senses vibration via piezoelectric suction cup sensor. Automatically calibrates to any instrument. Use for Acoustic or electric guitar, mandolin, banjo, violin, viola, cello, upright base and other acoustic instruments.

**SR600** .....\$24.65B



### VIOLIN/VIOLA/CELLO

Especially designed for orchestral stringed instruments, with a pickup that clips onto the bridge.

**SR1000V** .....\$39.90B



### DIGITAL CHROMATIC TUNER

LED display for in-tune confirmation, LCD simulated tuning meter, tuning range: C1-B7, reference pitch range: 435-445Hz, mic for acoustics & in-line for electrics, 1/4" input jack, auto power off, uses 2 AAA batteries.

**SR1060** .....\$24.99B



### PEDAL TUNER

Lighted dial & large LED display. When tuner is activated by the foot pedal, the line-out shuts down allowing the player to tune without sounding thru the amplifier. 9V Battery powered. Battery eliminator power input jack.

**SR3000** Chromatic .....\$71.99B

# SNARK TUNERS

## GUITAR/BASS



Full color display • Display rotates 360 degrees for easy viewing • “Stay put” clip • Tap tempo metronome • Flat tuning/transpose • Pitch calibration (415-466Hz)

SN1 .....\$29.00\*

## CHROMATIC



Tap tempo metronome • Pitch calibration (415-466Hz) • High sensitivity vibration sensor • Features extended frequency range for all instruments • Choose internal mic or vibration sensor.

SN2 .....\$39.00\*  
S1 Son of Snark.....\$39.00\*

## GUITAR/BASS



Full color display • Tune using built-in mic or input jack • Electronic pitch-pipe plays • C C# D D# E F F# G G# A A# B • Built in speaker • Tap tempo metronome.

SN3 .....\$29.00\*

## ALL INSTRUMENT



Built in speaker • Tap tempo metronome • Pitch calibration (415-466Hz) • Fully chromatic tuning • Extended frequency range for tuning all instruments.

SN4 .....\$39.00\*

## GUITAR/BASS/VIOLIN



Full color display • Place anywhere on front or back of headstock (no dead spots!) • Display rotates 360 degrees (works for right or left handed players) • “Stay put” clip.

SN5 .....\$19.00\*

## UKULELE



Full color display • Fast and ultra accurate tuning • Display rotates 360 degrees • “Stay put” clip.

SN6 .....\$19.00\*

## CHROMATIC



Super tight with a larger, brighter display • Display rotates 360 degrees • Stay put clip • Fast and deadly accurate • Tap tempo metronome • Pitch calibration 415-466 Hz • Transpose feature • High-sensitivity vibration sensor • Extended frequency range suitable for ALL instruments.

SN8 .....\$39.00\*

## PEDAL TUNER CHROMATIC



Big & bright display, fully chromatic, blazingly fast, die cast metal case, true bypass switching.

SN10S .....\$59.00\*

## FISHMAN



Fully chromatic, automatically displays the note. Meter style “needle” display is accurate to 1 cent. Flip it up to turn it on, flip it down to turn it off. Large, easy to read LCD display lights green when in-tune, red for sharp, amber for flat. Fully chromatic, automatically displays the note. Meter style “needle” display.

FTFT2 .....\$19.49

## ON/STAGE TUNER



Clip-on chromatic tuner is especially well-suited for guitar, bass, ukulele, mandolin, banjo, and similar instruments. The high contrast 3-color screen offers excellent visibility in any lighting. Sharp, Flat and In-Tune indicators ensure confident tuning.

GTA6000 .....\$21.99

## YAMAHA TUNER



The YGCT1 is a clip on chromatic tuner with a portable design, making it easy to go with you and it can be easily rotated in different directions and angles to give you a clear view while tuning. Tuning scale: Chromatic w/strobe, guitar, violin, ukulele C, ukulele D.

YGCT1 Clip on Chromatic .....\$16.00

## FENDER TUNER



The small format FT004 Fender Clip-On tuner is easy to operate even under darkened stage conditions. Built-in vibration sensor for accurate tuning even in noisy areas. The large LCD display with easy-to-read needle shows white when out of tune and bright green when in tune. Small, compact size one-handed swivel clamp. Tuning modes include: Guitar, Bass, Ukulele, Violin and Chromatic.

FT004 Chromatic Clip-On Tuner .....\$19.99

## PLANET WAVE/ D'ADDARIO TUNER



### NS MINI HEADSTOCK TUNER

The NS Mini Tuner precisely tunes guitars, basses and other stringed instruments while its low-profile design blends with the aesthetics of your instrument, concealing it from your audience. The highly sensitive piezo transducer and backlit display allow for easy and accurate tuning in noisy, dim or well-lit environments where other tuners fail. Enjoy effortless and inconspicuous tuning with the NS Mini Headstock Tuner.

PWCT12 .....\$32.99

## GROVER TUNER



Full function tuner has incredibly bright, colorful screen for easy viewing in any lighting situation.

GP680T .....\$18.90

## INTELLITOUCH



**CHROMATIC**  
**IPT10XL** .....\$29.95  
**CP10XL W/Metronome**.....\$34.95



It is automatic, chromatic, and displays the measured pitch on a large, backlit display for easy tuning.  
**IPT20** .....\$39.95  
**IPT40** Rechargeable .....\$49.95



**CLIP ON**  
**IPT10** Traditional .....\$39.95  
**IPT50** Bravo Metronome/  
 Tuner .....\$39.95  
**CP10MINI** Center Pitch .....\$39.95



The Intellitouch® CT1 Capo Tuner combines vibration-based tuning with a single action capo.  
**ICT1** .....\$54.95

## QWIK TUNE



Automatic guitar and bass tuner.  
**QT15**.....\$17.95\*



Guitar Professor® guitar tuner/chord finder/pitch pipe.  
**QTGP1**.....\$19.95\*



Tunes severely out-of-tune guitars, electronic pitch pipe.  
**QT11** .....\$19.95\*

## INTELLITOUCH FREEDOM ONE



**COMPACT DIGITAL WIRELESS SYSTEM**  
 Less tone loss than a cable. No need to give up room on your pedal board for a wireless system – it replaces your pedal tuner. It's the most affordable digital wireless system available. RF range: approximately 30 ft. No more changing batteries in the middle of a gig. 10 hour transmitter battery life. Pure 24-bit digital audio with zero compression or squelch artifacts.  
**WT1** .....\$149.95

## PEAVEY TUNERS



**SPT-6G™ II TUNER**  
 Fast & accurate LEDs for precision tuning. Includes 1/4" input jack. Tuner will automatically shut off if not used in 20 minutes.  
**03011410** .....\$14.99



**PT-C01 CLIP ON TUNER**  
 Tuning mode: Chromatic/Guitar/Bass/Violin/Ukulele tuner. Clip on chromatic tuner with color display.  
**03014060** .....\$17.99B

## WITTNER TUNERS



Easy to operate Quartz Tuner shows immediately when pitch is attained.  
**GT30** .....\$34.99B  
**VT100** Violin .....\$44.50B

## TUNING MICS



**ACOUSTIC GUITAR**  
**MPU1** .....\$15.90  
**WCP60G** Cherub .....\$11.95  
**BAND & ORCH**  
**MPU2** .....\$20.30  
**PETP3** (Peterson) .....\$16.95  
**WCP60V** Cherub Violin .....\$11.95  
**WST550VM** Cherub Violin .....\$21.95

## CHERUB TUNERS



**GUITAR/BASS TUNER**  
 Glossy finish with a skull on the case. Two-color LED gives clear indication of sharp or flat.  
**ST711** Transparent.....\$10.35  
**ST711A** White .....\$10.35



**DUAL DISPLAY ORCHESTRAL TUNER**  
 WST-920 is a new tuner that combines the accuracy of needle-type meter with superior functionality, wide tuning range and a new, sleek horizontal design.  
**WST920** .....\$118.00

## FENDER



Sparkle auto tuners. Available in Blue (SB), Red (SR)  
**AG6** .....\$30.25

## YAMAHA



**YYT150** Guitar/Bass .....\$34.99  
**YYT250** Chromatic.....\$44.95  
**YTD5** Chromatic .....\$89.99B  
**YTD100** Chromatic .....\$150.00B

\* = CALL FOR DEALER PRICE

# CHAUVET LIGHTING

## GEYSER



Emits vertical blasts of color, fog and light at once. The water-based fog is illuminated by 21 high-power red, green and blue LEDs.

**GRGB**.....\$559.99\*  
**GRGBJR** 9 High Power .....419.99\*

## HURRICANE 700



- 0.6L tank capacity
- Fog fluid included (0.5L)
- 4 minute heat up
- Manual fog button
- Wired remote included
- Water-based fogger

**H700** .....\$59.99\*

## HURRICANE 1100



- 1.3L tank capacity
- 5 minute heat up
- Manual fog button
- Low fluid indicator and auto shut down
- LED-illuminated tank
- Wired remote included
- Water-based fogger

**H1100**.....\$139.99\*

### FOG FLUID

**FJU** Gallon.....\$39.99\*  
**FIQ** Quart.....11.99\*

## MINI STROBE LED



Ultra compact and lightweight strobe light perfect for any party. It's ready-to-go out of the box. Simply plug the unit in, and adjust the flash rate for the desired effect. LED power means it will run all night and stay cool to the touch.

**MSLED**.....\$19.99\*

## HURRICANE™ HAZE 3D



Continuous, high output suitable for filling large rooms quickly. Built-in digital display for easily controlling DMX functions, and a wired, timer remote complete with storage compartment.

**HHAZE3D**.....\$579.99\*

## HURRICANE 1301



- Tank capacity: 3.3L
- 20,000 cu ft/min
- Heat up time: 5 minutes
- A wired timer remote (FCT) is also included.

**H1301** .....\$249.99\*

## DJ BANK



- Compact border, strip or cyc light
- Sound activated
- Fully automatic

**DJBANK**.....\$109.99\*

## LED PINSPOUT 2



- Light source: 3W white LED
- Beam angle: 6° or 9° (depending on lens used)
- 4-pack of colored gels included
- AC power: autoswitching 100V-240V 50/60Hz, 0.1A
- Size: 7.6 x 4.2 x 5.9 in (193 x 105 x 148mm)

**LEDPS2** .....\$59.99\*

## CUBIX 2.0



Cubix™ 2.0 is a multicolored, LED centerpiece that combines two effects in one fixture. Centrally-mounted LEDs produce multi-colored effects and animations that flow across the room.

**CUBIX20**.....\$249.99\*

## COLORRAIL



- 320 (10mm) LEDs
- 128 red, 96 green, 96 blue
- 13° (per section)
- 20° (per section)
- 770 (per section)

**CR**.....\$239.99\*

## COLORSTRIP



- 384 (5mm) LEDs
- 128 red, 128 green, 128 blue
- 53° x 27°
- 68° x 46°
- 1,127

**CS**.....\$219.99\*

## COLORSTRIP™ MINI



- 192 (5mm) LEDs
- 64 red, 64 green, 64 blue
- 37° x 33°
- 68° x 51°
- 820

**CSM**.....\$129.99\*

\* = CALL FOR DEALER PRICE

# CHAUVET LIGHTING

## MINI 4BAR



The Mini 4BAR™ is an easy to use solution for LED wash lighting. The independently adjustable pods are controlled from an included footswitch that allows the user to easily step through static colors and dynamic programs including sound-activated looks. The entire system sits atop an included tripod and packs up into 2 included travel cases.

**M4BAR** .....\$399.99\*

## INTIMIDATOR SPOT LED 150

Intimidator™ Spot LED 150 is a compact, LED moving head with crisp optics and an even output. Powered by a 25-watt white LED, it includes 9 gobos and 9 colors on separate wheels for maximum effects.



**ISPOTL150** .....\$559.99\*

## INTIMIDATOR SPOT LED 250

Intimidator™ Spot LED 250 is a feature-packed moving head spot fitted with a 50-watt LED to flood any event with colorful beams and crisp gobos. It features an easily accessible gobo door to facilitate quick changes, an electronic dinner for smooth LED fading and a 3-facet prism that splits the beam for maximum effects and coverage.



**ISPOTL250** .....\$839.99\*

## INTIMIDATOR SPOT LED 350

Rotating, 3-facet prism splits the beam for maximum effects and coverage, while interchangeable gobos let you vary and customize the show.

**ISPOTL350** .....\$1259.00\*

## LED WASH SYSTEM



### CONTROL FEATURES

- 15-channel DMX-512 LED wash light system
- RGB control of 4 separate lights
- Built-in automated programs via master/slave or DMX
- Built-in sound activated programs via master/slave or DMX

### ADDITIONAL FEATURES

- Independent positioning of each light
- Low-profile lights are 1.7" deep
- Adjustable stand from 56" to 91"

**4BAR** .....\$574.99\*

### SPECIFICATIONS

- Beam angle: 21° (per light)
- Field angle: 33° (per light)
- Lux: 980 @ 1m (per light)
- Light source: 432 (144 red, 144 green, 144 blue) 10mm LEDs (108 per light)

### FOOTSWITCH

- Trigger built-in static or automated programs (includes RGB fades)
- Instantly set any program to sound active
- Instantly blackout any program



## POWER PANEL

PC-08 power panel provides easily accessible power switches for all your gear. The single rack space fixture features 8 illuminated switches capable of handling 15A each.

**PC08** .....\$42.99\*

## PORTABLE TRUSSING

- Easy setup
- Safety pins
- 16 mounting screws included
- T-bars
- Load capacity: 200 lbs evenly distributed
- 10 ft trussing span
- Size: 9 ft fully extended
- Shipping Weight: 46 lbs

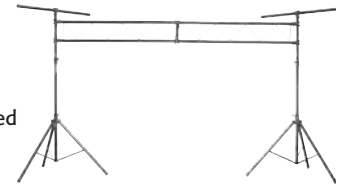

**CH31** .....\$224.99\*

## 4BAR FLEX

4BAR™ Flex upgrades the popular 4BAR™ with added flexibility and more features. It includes two floor stands (L-brackets) to maximize set up options and configurations. A pass-through hole easily mounts the fixture to most tripods and speaker stands without the need for additional clamps.



**4BARFLEX** .....\$459.99\*

## COREBAR 4

COREbar™ 4 is a complete, all-in-one mobile wash lighting solution. It produces a full spectrum of light with unsurpassed color mixing using chip-on-board (COB) technology. Achieve total room or stage coverage with four individually adjustable heads and easily set up and tear down in minutes using the included tripod, footswitch, and carry bag.



**COREBAR4** .....\$559.99\*

## PIPE CLAMPS



- Weight capacity: 55 lbs
- Size: 7 in
- Weight capacity: 44 lbs
- Size: 6 in
- Load capacity: 75 lbs.
- 360° wrap around pipe
- Fits: 1in, 1.5in, 2in truss

**CLP02** .....\$5.99\* **CLP03** .....\$4.50\* **CLP10** .....\$12.99\*

## LED MUSHROOM

### CONTROL FEATURES

- 2-channel DMX-512 LED derby effect
- Continuous rotation or back and forth motor control
- Built-in automated programs via master/slave or DMX (rotation only)
- Built-in sound activated programs via master/slave or DMX (rotation only)

### ADDITIONAL FEATURES

- High-power, 3W (730mA) LEDs
- Linkable with Kinta™ X and Double Derby™ X
- Additional power output: max 37 units @ 120V



### SPECIFICATIONS

- Coverage angle: 130°
- Light source: 3 x 3W (730mA) LEDs (1 red, 1 green, 1 blue)
- Power and current: 120V, 60Hz, 24W, 0.2A operating, 0.5A inrush

**LEDMR** .....\$139.99\*

\* = CALL FOR DEALER PRICE

# CHAUVET LIGHTING



## MINI KINTA

Mini Kinta™ is a sturdy effect light that fills the room with sharp beams. Fitted with four 3-watt RGBW LEDs to punch through nearly any ambient lighting, it produces more output and broader coverage than derby effects twice its size. Mini Kinta™ features 48 lenses for dynamic effects at adjustable speed. Let the built-in programs do the work or use DMX to program your own light show.

**MKINTA** .....\$129.99\*



## SWARM 5 FX

Swarm™ 5 FX is a 3-in-1 LED fixture that combines red and green lasers, white strobe effects, and RGBAW rotating derby effects into one compact set-up. Match the look of any event by creating customized light shows with separate color and program control. Quickly create a look using built-in automated and sound-activated programs, or master/slave and DMX mode. Create a synchronized light show and save time running cables and extension cords by power-linking multiple units.

**S5FX** .....\$299.99\*



## LED PALET

Source:	288 (5mm) LEDs	Control Channels:	6, 9, 15 or 27
Configuration:	96 red, 96 green, 96 blue	Stand Alone Color Mixing:	Yes
Beam Angle:	31° x 29°	Built-in Automated Programs:	Yes
Field Angle:	56° x 54°	Built-in Sound	
Lux @ 1 m:	1,334	Automated Programs:	Yes

**LEDP** .....\$209.99\*



## CIRCUS

The Circus™ is a dazzling, ever-changing effect light with razor-sharp, flowing beams. Five separate, synchronized pods create amazing effects both in the air and projected onto any surface. The red, green, blue, white and amber LEDs provide a multitude of colors in nearly endless combinations.

**CIRCUS** .....\$289.99\*



## EZMIN LASER FX

It has a run time of up to 6 hours from a single charge with the rechargeable, lithium battery. Create customized shows with independent control of red and green laser diodes and easily generate eye-catching effects with sound-activated and automated programs. It covers a wide area and looks great with or without fog. Easily set color and rotation speeds with the included wireless remote control.

**EZMINLFX** .....\$169.99\*



## EZMIN LASER RBX

It has a run time of up to 6 hours from a single charge with the rechargeable, lithium battery. Create customized shows with independent control of red and green laser diodes and easily generate eye-catching effects with sound-activated and automated programs. It covers a wide area and looks great with or without fog. Easily set color and rotation speeds with the included wireless remote control.

**EZMINLRBX** .....\$179.99\*



## LED MOONFLOWER EFFECT

### FEATURES

- LED moonflower effect
- Selectable functions: sound, rotating
- Additional power output: max 50 units @ 120V

**LX5** .....\$89.99\*



## SCORPION STORM MG

### FEATURES

- Compact, high powered laser effect
- Operating modes: automatic, sound activation, master/slave, manual
- Creates a unique star field effect with many patterns and hundreds of beams
- Pattern and speed knobs for automatic mode
- Built-in automated programs via master/slave
- Built-in sound activated programs via master/slave

**SSMG** .....\$249.99\*

\* = CALL FOR DEALER PRICE

# CHAUVET LIGHTING



## TECHNO STROBE 2000S

Techno Strobe™ 2000S is a simple, sound-activated strobe light with an adjustable strobe rate.

**ST2000S** .....\$79.99\*



## MINI STROBE LED

Mini Strobe™ LED is an ultra-compact and light-weight strobe light. Simply plug the unit in, and adjust the flash rate for the desired effect. LED power means it will run all night and stay cool to the touch.

**MSLED** .....\$19.99\*



## OBEY 3

Obey™ 3 is a compact DMX controller for LED lights with 3 channels (red, green and blue only). Playback options included automated, sound-activated or manual RGB color mixing.

Specifications:

• DMX Channels: 3 • Input Voltage: 9 VOC, 500mA (external power supply: 100 to 240 VAC, 60/60 Hz) • Weight: 2 lb. (0.9 kg) • Size: 5.5 x 8.3 x 2.1 in (140 x 210 x 52 mm)

**OBEY3** .....\$74.99\*



## OBEY 40

• Universal DMX-512 controller • Controls up to 12 intelligent lights of up to 16 channels each • 30 banks of 8 scenes, 240 scenes max • 192 DMX channels of control • 6 sets of chases containing 240 scenes • Program fade and speed time into each step • Reversible sliders • Re-assignable channels • Sequential linking of chases.

**OBEY40** .....\$189.99\*



## BUBBLE MACHINE™

• Bubbles rise • Plastic construction prevents rust • Manual bubble button • Easily removable fluid tank • Size: 12.5 in x 7 in x 6.5 in

**B250** .....\$114.99\*

**BJU** Gallon, Bubble Juice.....\$29.99\*



## OBEY 10

• Universal DMX-512 controller • Controls up to 8 intelligent lights of up to 16 channels each • 128 DMX channels of control • 6 sets of chases containing 999 steps each • Program fade and speed time into each step • Reversible sliders • Re-assignable channels • Sequential linking of chases • Grab any fixture on the fly • Beat activation and auto run • DMX polarity selector • 2-space (2U) rack mount

**OBEY10** .....\$149.99\*

## L.E.D. PAR CANS



### SLIMPAR™ 38

#### Output

Source: 75 (10mm) LEDs  
Configuration: red, green, blue  
Beam Angle: 17°  
Field Angle: 29°  
Lux @ 1 m: 1,500

#### DMX

Control Channels: 3 or 7  
Stand Alone Color Mixing: Yes  
Automated Programs: Yes  
Sound Activated Programs: Yes

#### Physical

Size: 7.3 x 8.1 x 2.5 in  
(185 x 206 x 64mm)  
Weight: 1.8 lbs. (0.8kg)  
Power Connection: IEC, Satellite™  
Control Connection: 3-pin DMX

**SP38** .....\$99.99\*



### SLIMPAR™ 56

#### Output

Source: 108 (10mm) LEDs  
Configuration: red, green, blue  
Beam Angle: 21°  
Field Angle: 32°  
Lux @ 1 m: 1,290

#### DMX

Control Channels: 3 or 7  
Stand Alone Color Mixing: Yes  
Automated Programs: Yes  
Sound Activated Programs: Yes

#### Physical

Size: 9.5 x 8.8 x 2.2 in  
(241 x 224 x 56mm)  
Weight: 2.7 lbs. (1.2kg)  
Power Connection: IEC, Satellite™  
Control Connection: 3-pin DMX

**SP56** .....\$109.99\*



### SLIMPAR™ 64

#### Output

Source: 180 (10mm) LEDs  
Configuration: red, green, blue  
Beam Angle: 23°  
Field Angle: 38°  
Lux @ 1 m: 3,640

#### DMX

Control Channels: 3 or 7  
Stand Alone Color Mixing: Yes  
Automated Programs: Yes  
Sound Activated Programs: Yes

#### Physical

Size: 9.7 x 11.1 x 2.5 in  
(246 x 282 x 63mm)  
Weight: 2.8 lbs. (1.3kg)  
Power Connection: IEC, Satellite™  
Control Connection: 3-pin DMX

**SP64** .....\$139.99\*



### SLIMPAR™ 64 RGBA

#### Output

Source: 180 (10mm) LEDs  
Configuration: 39 red, 39 green, 51 blue, 51 amber  
0.25 W (20 mA), 100,000 hours  
Beam Angle: 14°  
Lux @ 2 m: 1,325

#### DMX

Control Channels: 4 or 8

#### Physical

Size: 10.8 x 10.8 x 2.6 in  
(276 x 276 x 66mm)  
Weight: 2.8 lbs. (1.3kg)

Input Voltage: 100 to 240 VAC,  
50/60 Hz (auto-ranging)

**SP64RGBA** .....\$159.99\*

\* = CALL FOR DEALER PRICE



## LITTLITE



### SETS

"L" series sets come complete and ready for easy surface mounting. All sets are available in 12 or 18 inch lengths with bulb, mounting base and fully adjustable dimmer.

#### HIGH INTENSITY SERIES

ATTACHED LAMP W/BASE	
L312 12"	\$66.75B
L318 18"	66.75B

#### LOW INTENSITY SERIES

ATTACHED LAMP W/BASE	
L212 12"	\$55.40B
L218 18"	55.40B



### LED SETS

ATTACHED LAMP W/BASE	
L12LED 12" w/Power Supply	\$99.95B
L18LED 18" w/Power Supply	99.95B
L12ALED 12" w/o Power Supply	86.75B
L18ALED 18" w/o Power Supply	86.75B

#### HI INTENSITY DETACHABLE LAMP W/BASE

L712LED 12" w/Power Supply	\$99.50B
L718LED 18" w/Power Supply	99.95B
L712ALED 12" w/o Power Supply	86.30B
L718ALED 18" w/o Power Supply	86.30B

#### INDIVIDUAL LED GOOSENECKS

L12GLED 12" BNC	\$65.98B
L18GLED 18" BNC	65.98B
L12XRLED 12" XLR RA	88.00B
L18XR4LED 18" XLR RA, 4 Pin	90.35B

#### MUSIC LIGHT STANDS

LMS12AHI 12" High Intensity	\$61.10B
LMS18AHI 18" High Intensity	61.10B
LMS12HI 12" High Intensity	75.60B
LMS18HI 18" High Intensity	75.60B
LMS12ALED 12" LED	95.75B
LMS18ALED 18" LED	95.75B
LMS12LED 12" LED	107.65B
LMS18LED 18" LED	107.65B

A Series require Power Supply

## LUMIN EZE



LEXLR1	Plug-in to XLR, 12" extension	\$48.75B
LEMINI	Clamp-on with trapeze adjustment	60.75B
LE1S	Clamp-on with 12" extension	70.50B
LEBNC1	Plug-in to BNC connector	50.25B
LEB	Replacement Bulb	2.50

#### ACCESSORIES

LSM	Snap Mount	\$4.95B
LQ5	5-Watt Bulb	9.00B
LQ52	5-Watt Bulb, 2 Pack	15.00B
L1815	2.4 Watt Bulb	3.25B
L18152	2.4 Watt Bulb, 2 Pack	5.75B
LRWB	Round Weighted Base	26.80B
LCF	Filter Set	4.20B
LHTC	High Tension Clip	10.30B
LWXF	Power Transformer	17.60B

## GOOSENECK LAMPS



#### LOW INTENSITY

L12G	12", BNC	\$32.30B
L18G	18", BNC	32.30B
L12X	12", XLR	39.15B
LTE297	15", XLR Hosa	33.30
LTE238	15", BNC Hosa	30.30
BLB242	Bulb	3.50/2
BLB242H	Halogen Bulb	8.85

#### HIGH INTENSITY

L12GHI	12", BNC	\$43.60B
L18GHI	18", BNC	43.60B
L18XHI	18" XLR	50.55B
L18XHI4	18", XLR, 4 Pin	64.70B

#### RIGHT ANGLE HI INTENSITY

L6XRHI	6" XLR	\$63.20B
L12XRHI	12" XLR	63.20B
L18XRHI	18" XLR	63.20B
L6XRHI-4	6" XLR, 4 Pin	78.35B
L12XRHI-4	12" XLR, 4 Pin	78.35B
L18XRHI-4	18" XLR, 4 Pin	78.35B

#### RACKLITE GOOSENECK

RL10S		\$105.00B
-------	--	-----------

## ON/STAGE

### CLIP ON LED LIGHTS



Two bright white intensity LED lights on a single gooseneck. Two brightness levels with a 3-way switch allow options for both LEDs on, 1 LED on, or off. The flexible gooseneck attachment allows for easy positioning at any angle.

LED102.....\$18.99

Each of the goosneck-mounted lamp heads features a pair of high intensity white LEDs. A 3-way switch on each lamp head lets you choose 2 LEDs, 1 LED, or Off to suit your personal lighting needs.

LED204.....\$27.99



#### CLIP-ON LED ORCHESTRA LIGHT

10 LED lights illuminates up to 4 pages. 3-way power button located on base to control High/Low/Off without accidentally changing the light's position. Easy access to AC adapter plug. 11" adjustable goosneck allows optimal positioning. **AC Adapter, 3 AA batteries and carry bag included.**

LED510.....\$65.99

Our Clip-on LED light features two adjustable bright white intensity LED lights, which illuminate two sheets of music. Flexible goosneck attachment. Each light has its own on/off switch, allowing for the light level to be adjusted as well.

LED202.....\$25.99

LED202R Red Lights.....25.99

The compact design also sits flat on a desktop! All lights are powered by (3) AAA batteries (included) and the batteries last for days without the light fading.

## POWER RACKS



#### JUICE GOOSE

A rack mountable power source with eight 120 volt power outputs. Fifteen amps of power. Includes AC line conditioning and spike protection.

JG80 .....\$92.20\*

All the features of the JG 8.0 plus two dimmable pull-out tubular lights anodized.

JG80L .....119.00\*

JGJR 6 outlet .....66.00\*

\* = CALL FOR DEALER COST

## GRILL CLOTH

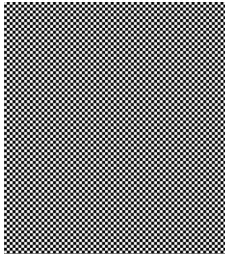

Black Grill Cloth, 72" Wide Fabric

**FA1092** Per Yard.....\$47.35

## AMP HANDLES



### FENDER

**6129** 9" Leather, Brown.....\$20.70  
**0943** Molded Black "Dogbone"  
w/Hardware, 2 Screws.....13.80  
**0944** Brown Vintage 1 Screw.....15.30  
**0945** Vintage Leather Brown.....26.80  
**0946** Molded Brown "Dogbone".....12.75  
**0947** Vintage Black 1 Screw.....15.30  
**0948** Standard Black w/Hardware,  
2 Screws.....13.80  
**6784085** Molded Brown "Dogbone"  
No Hardware.....5.75  
**9094085** Molded Black "Dogbone"  
No Hardware.....5.75

## SPEAKER GRILLS

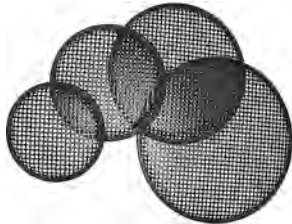

### GRILLS & CLAMPS

**SG8** Steel, 8".....1 \$5.75  
**SG10** Steel, 10".....1 7.45  
**SG12** Steel, 12".....1 10.10  
**SG15** Steel, 15".....1 12.60

## RACK CASES



### TKL

**A1081** 2 space.....\$158.85  
**A1083** 4 space.....196.80  
**A1084** 6 space.....234.60  
**A1085** 8 space.....261.05  
**A1086** 10 space.....321.60  
**A1087** 12 space.....340.40

## AMP CORNERS GLIDES



**3900** Fender sphinx glides.....\$11.50  
**EB6109** Ernie Ball glides.....8.00  
**1348** Fender amp corners, 2-screw.....9.20  
**1350** Rhodes corners, 3-screw.....9.20  
**EB6106** Ernie Ball, with Lip.....8.00  
**EB6107** Ernie Ball, no Lip.....8.00  
**0712** Fender, 16' Tilt Legs.....63.15  
**0713** Fender, 19' Tilt Legs.....68.85  
**0714** Fender, 14' Tilt Legs.....57.40

### HOSA AIR GEAR DUSTER

**AIR464** 10 oz. ....\$14.55

## PEAVEY® ACCESSORIES



## HARDWARE

**00051600** Small Rubber Fee (pkg. 4).....\$4.99B  
**00051610** Large Rubber Fee (pkg. 4).....5.99B  
**03006950** 2" Hard Rubber Caster.....9.39B  
**00051300** Metal Glide Feet (pkg. 4).....5.39B  
**00576000** Metal Recessed Handle.....14.79B  
**00052590** Black with Black  
Retainer Strap Handle.....5.99B  
**00051700** Black with Chrome  
Retainer Strap Handle.....5.99B  
**00051220** Pop Out Caster Set.....25.99B

## AMP COVERING



**FA3015** Black Tolex, 54" x 36".....\$41.70

## AMP CASTERS



**EB6101** E. Ball, Flush Mount.....\$33.00  
**EB6102** E. Ball, Pop In.....38.00  
**4000** Fender, Pop In.....47.25

## FUSES/HOLDERS

**RFU20MDL** 2 Amp, Slo Blo.....\$1.05  
**RFU25MDL** 2.5 Amp, Slo Blo.....1.05  
**RFU30MDL** 3 Amp, Slo Blo.....1.05  
**RFUH003** American Holder.....4.45

## AMP CASES



### AMP UTILITY CASES

**SKB710** 28.75" x 13.75" x 26.75".....\$614.99  
**SKBSCPS1** Powered Speaker Case  
w/wheels and handle.....281.99

## RACK BAGS



### TKL

Plywood rack case with nylon covering. Steel rack  
rails, shoulder straps and accessory pouch.  
**B4863** 4 space, 12" deep.....\$193.55

# SKB CASES



<b>RACKS</b>		
<b>SKB192U</b>	2U Effects ATA 19" rack.....	<b>\$254.99</b>
<b>SKB193U</b>	3U effects ATA 19" rack.....	<b>264.99</b>
<b>SKB194U</b>	4U effects ATA 19" rack.....	<b>299.99</b>
<b>SKB196U</b>	6U effects ATA 19" rack.....	<b>324.99</b>
<b>SKB198U</b>	8U effects ATA 19" rack.....	<b>429.99</b>
<b>SKB1910U</b>	10U effects ATA 19" rack.....	<b>454.99</b>
<b>SKB1912U</b>	12U effects ATA 19" rack.....	<b>489.99</b>
<b>SKB19AC1</b>	Spare hardware for rack (12 ea.).....	<b>34.99</b>
<b>SKBDRW4</b>	4U Drawer.....	<b>209.99</b>

<b>SHALLOW RACKS</b>		
<b>SKBXRACK2</b>	2U, 10 1/2" Deep .....	<b>\$149.99</b>
<b>SKBXRACK3</b>	3U, 10 1/2" Deep .....	<b>174.99</b>
<b>SKBXRACK4</b>	4U, 10 1/2" Deep .....	<b>199.99</b>

<b>REAR RAIL KITS</b>		
<b>SKBRRK6</b>	6 Space .....	<b>\$39.99</b>
<b>SKBRRK8</b>	8 Space .....	<b>44.90</b>
<b>SKBRRK10</b>	10 Space .....	<b>59.99</b>



<b>SKBR1400</b>	Gig Safe, 14U.....	<b>\$449.99</b>
<b>SKBR3224</b>	Gig Dolly w/wheels.....	<b>229.99</b>



<b>DJ CASES</b>		
<b>SKB106DJ</b>	DJ Station.....	<b>\$249.99</b>
<b>SKBSC2709</b>	MIDI Foot Controller.....	<b>89.99</b>
<b>SKBR104</b>	10 x 4 Roto Rock .....	<b>344.99</b>
<b>SKBR106</b>	10 x 6 Roto Rock .....	<b>394.99</b>

## UNIVERSAL TRANSPORT BAGS



Will accommodate the most popular mixers, drum machines, recording interfaces, midi controllers, light panels and other equipment. These bags are constructed of a durable 600 Denier padded exterior with heavy-duty dual zippers, and adjustable, padded shoulder strap and double stitched carrying handle for added convenience. The bags include a convenient, double zippered padded exterior accessory compartment that is large enough to keep your iPad protected while stowing cables or additional gear.

<b>SKBUB0909</b>	Universal Equipment/Mixer Bag, 9x9x2.5.....	<b>\$49.99</b>
<b>SKBUB1212</b>	Universal Equipment/Mixer Bag, 12x12x4.....	<b>59.99</b>
<b>SKBUB1515</b>	Universal Equipment/Mixer Bag, 15x15x5.....	<b>64.99</b>
<b>SKBUB1818</b>	Universal Equipment/Mixer Bag, 18x18x5.....	<b>79.99</b>
<b>SKBUB2020</b>	Universal Equipment/Mixer Bag, 20x20x5.....	<b>94.99</b>



<b>MIXER CASES</b>		
<b>SKB19P12</b>	ATA Pop-up 12U Mixer Case .....	<b>\$404.99</b>
<b>SKBSCPM2</b>	Large Rolling Powered Mixer (Mackie).....	<b>167.99</b>



<b>GIG RIGS</b>		
<b>SKB191006</b>	Mini Gig Rig.....	<b>\$579.99</b>
<b>SKB191006V</b>	Mini Gig Rig w/Velcro Pop-Up Rack.....	<b>629.99</b>
<b>SKB191010</b>	Gig Rig .....	<b>884.99</b>
<b>SKB191010V</b>	Gig Rig w/Velcro Pop-Up Rack.....	<b>849.99</b>
<b>SKB19R1406</b>	Gig Rig, 14U Top, 6U Front.....	<b>919.99</b>
<b>SKB19REX6</b>	6U Expander for SKB19R1406 .....	<b>484.99</b>
<b>SKBAV8</b>	19" AV shelf for 8U+ slant top racks.....	<b>93.99</b>
<b>SKBPDL</b>	TSA Pad Locks (2-pack).....	<b>19.99</b>



<b>SKB PEDAL BOARD CASES</b>		
<b>SKBPS8</b>	8-port Powered – 9VDC w/Gigbag.....	<b>\$169.99</b>
<b>SKBPS8PRO</b>	8-port Powered – 9VDC w/Soft Case .....	<b>274.99</b>
<b>SKBFN8</b>	SKB has developed the world's first AC/DC pedalboard with a built-in combo amp featuring a 6" Eminence speaker. The SKBFN8 FootNote® Amplified Pedalboard is a fully powered pedalboard that will accommodate up to eight 9 volt DC pedal and can be taken anywhere.....	<b>299.99</b>
<b>SKBSC2111</b>	Foot Controller Soft Case (VG99, FC300, RP1000, M13).....	<b>84.99</b>
<b>SKBSC2316</b>	Soft Case for PS-8 and PS-15 .....	<b>114.99</b>
<b>SKBPS55</b>	Stage 5 .....	<b>559.99</b>
<b>SKBPS45</b>	8 protected 9V DC outlets, 100 MA per outlet 1A maximum combined current for all outlets. Three widely spaced 120V AC, 15A outlets, allows enough room for "Wall warts". (8) 3.5mm miniplug to 2.1mm x 5mm DC connector .....	<b>504.99</b>
<b>SKBPSAC2</b>	9V adapter cable kit .....	<b>34.99</b>

# SKB CASES



## ROLL X RACKS

Rolling Rack Cases with collapsible handles, and 2 1/2" wheels.

<b>SKBRLX3</b>	3U .....	<b>\$284.99</b>
<b>SKBRLX4</b>	4U .....	<b>299.99</b>
<b>SKBRLX5</b>	5U .....	<b>314.99</b>
<b>SKBRLX6</b>	6U .....	<b>334.99</b>

## ROTO RACKS

Ultimate Strength Series Features:  
Threaded Front Rails. Rear Rail Kits are also Available

<b>SKBR2</b>	2U, 19" Deep .....	<b>\$189.99</b>
<b>SKBR4</b>	4U, 19" Deep .....	<b>219.99</b>
<b>SKBR6</b>	6U, 19" Deep .....	<b>259.99</b>
<b>SKBR8</b>	8U, 19" Deep .....	<b>339.99</b>
<b>SKBR10</b>	10U, 19" Deep .....	<b>364.99</b>
<b>SKBR12</b>	12U, 19" Deep .....	<b>394.99</b>
<b>SKBR6W</b>	6 Space w/wheels .....	<b>356.99</b>
<b>SKBR104</b>	Roto Rack 10x4 Rack Console .....	<b>344.99</b>
<b>SKBR106</b>	Roto Rack 10x6 Rack Console .....	<b>349.99</b>
<b>SKBSC191U</b>	1U Soft Rack Case, Steel Rails .....	<b>99.99</b>
<b>SKBSC192U</b>	2U Soft Rack Case, Steel Rails .....	<b>114.99</b>

## HOSA RACK STAND/ROLLING RACK

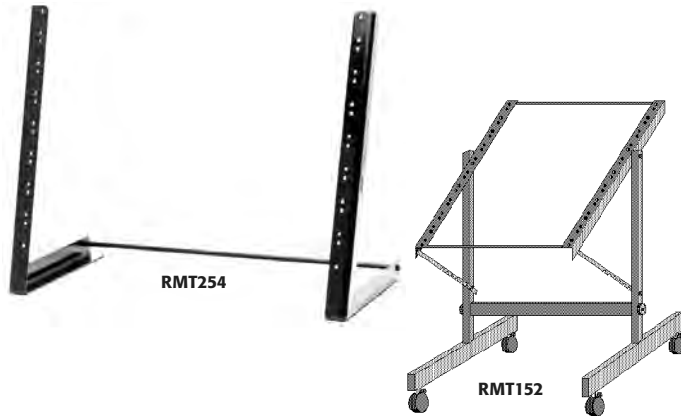

<b>RMT254</b>	11 space .....	<b>\$60.45</b>
<b>RMT152</b>	12 space, tilt adjustable, black studio rack with mounting screws. ....	<b>120.75</b>
<b>RMC180</b>	Screws & washers (24) .....	<b>6.20</b>

## ON/STAGE

<b>RS7030</b>	Table Top Rack Stand .....	<b>\$49.99</b>
---------------	----------------------------	----------------

## BOULDER CREEK ACOUSTIC AMPS



Two 1/4" inputs with separate volumes, guitar input plus balanced mic input, no phantom power feature, 15 watts RMS, 3 band EQ, digital chorus level control.

<b>A15CT</b>	.....	<b>\$159.00</b>
--------------	-------	-----------------

Two channel X 3 band EQ, CD/MP3 stereo inputs, 48V phantom power XLR input, 25 watts RMS, two 1/4" inputs (one per channel), foot switch jack, 8" full range speaker plus tweeter.

<b>A25D</b>	.....	<b>\$399.00</b>
-------------	-------	-----------------

## ASK ABOUT OUR PRINT MUSIC DEPARTMENT

**FAX & E-MAIL ORDERS FOR PRINTED  
MUSIC WILL GET AN EXTRA  
5% DISCOUNT**

**FAX:**

**(708) 496-2130 • (888) 983-5537**

**E-MAIL:**

**sales@harristeller.com**



Two channel X3 band EQ, CD/MP3 stereo inputs, 48V phantom power XLR input, 50 watts RMS, two 1/4" inputs, foot switch jack, 10" speaker plus tweeter.

<b>A50D</b>	.....	<b>\$499.00</b>
-------------	-------	-----------------

Stereo 2 channel pre-amp X3 band EQ, input impedance shift switch, 48V phantom power XLR input, 100 watts RMS (50 watts X2, stereo), foot switch jack, four 5.25" acoustic speakers.

<b>A100TS</b>	.....	<b>\$799.00</b>
---------------	-------	-----------------

## AMPLIFIER / MONITOR STANDS



**ON/STAGE**

**Small Foldable Tiltback Amp Stand**

The solid steel box frame design provides vibration dampening feet. Ideal for small amps and practice amps. Small locking tabs swing into place to keep the stand from opening during transportation.

**RS4000** ..... \$44.99



**ON/STAGE**

**Medium to Large Folding Tilt-back Amp Stand**

3/4" solid steel box frame. Folds flat for easy storage & transportation. Small locking tabs swing into place, keeping it from opening during transportation.

**RS6000** ..... \$64.99



**ON/STAGE**

**Tiltback Amp Stand for Stage/studio Amplifiers and Monitors**

The A-frame construction makes this stand extremely secure and stable even with heavy amplifiers. Non-slip rubber feet and a locking cross brace keep the stand, and your amp, firmly in place.

**RS7000** ..... \$86.99



**ON/STAGE**

**Tilt-back Tripod Amp Stand for Stage/studio Amplifiers and Monitors**

The heavy-duty steel tripod base adjusts to accommodate various sized amps. It features 5 tilt positions. The fold-and-go features a threaded end, for the addition of a mic or boom.

**RS7500** ..... \$55.99

The MSA7500CB is a 22" boom arm with a 7" adjustable mini boom arm designed for use with RS7500 Tiltback Amp Stand. Poli-Lok clutch design. Includes 2 cable clips to secure loose mic cords.

**MSA7500CB** ..... \$36.99



**ON/STAGE**

**Pro Tiltback Amp Stand for Stage/studio Amplifiers and Monitors**

A-Frame base, constructed of 1" square tubing, can be adjusted in order to get the most stable stance possible under your amp. Ridged end caps keep all metal surfaces off of the ground and act as a shock absorber.

**RS7705** ..... \$95.99



**K&M**

**Tripod Amp Stand**

Tripod base. Stable – holds up to 75 lbs. 3 tilt adjustment positions. Arms unfold from the legs to support your amp and fold up for streamlined portability. All one piece with no parts to lose. Top tube has standard mic boom threads.

**KM28130** ..... \$99.99

**Speaker Wall Mount**

Interchangeable Mounting Bolt

**KM241** ..... \$89.99

# BELCAT AMPLIFIERS

Powering Music Since 1988



## G-Series Amps

		List Price
<b>BG5</b>	5W Guitar Amp (4" spk.).....	\$77.00
<b>BG10</b>	10W Guitar Amp (5" spk.).....	99.00
<b>BG10T</b>	10W Amp / Built in Tuner.....	110.00
<b>BG15G</b>	15W Guitar Amp (6.5" spk.).....	122.00
<b>B15RG</b>	15W Reverb Amp (6.5" spk.).....	144.00
<b>B15B</b>	15W Bass Amp (6.5" spk.).....	122.00
<b>B25B</b>	25W Bass Amp (8" spk.).....	177.00



## Acoustic/ Keyboard Amps

All K-Series Amps feature:

- Dual channels w/LO-Z Microphone Inputs
- Stainless Steel Speaker Grilles
- Dual Built-in Speakers
- Deluxe Color Coded Tolex Cabinets

		List Price
<b>BKA15</b>	15W Acoustic Amp 8"+2.5" Speakers, Green.....	\$177.00
<b>BKA15C</b>	15W Acoustic Amp w/Chorus 8"+2.5" Speakers, Green.....	199.00
<b>BKA15R</b>	15W Acoustic Amp w/Reverb 8"+2.5" Speakers, Red.....	222.00
<b>BKA25C</b>	25W Acoustic Amp w/Chorus 10"+2.5" Speakers, Green.....	244.00



## Tweed Series

		List Price
<b>BV10G</b>	10W Vintage Guitar amp (5" speaker).....	\$109.00
<b>BV25G</b>	25W Vintage Guitar amp (8" speaker).....	177.00
<b>BV25RG</b>	25W Vintage / Reverb Amp (8" speaker).....	222.00
<b>BV35G</b>	35W Vintage Guitar Amp (10" speaker).....	222.00
<b>BV35RG</b>	35W Vintage / Reverb Amp (10" speaker).....	265.00
<b>BV15B</b>	35W Vintage Bass Amp (6.5" speaker).....	133.00
<b>BV25B</b>	25W Vintage Bass Amp (8" speaker).....	177.00



## Acoustic Guitar Amps

ACOUSTIC-25C DUAL CHANNEL W/CHORUS

		List Price
<b>BA15C</b>	15W Acoustic Amp w/Chorus (6.5" spk).....	\$155.00
<b>BA25C</b>	25W Acoustic Amp w/Chorus (8" spk).....	222.00

## Tilt 15 Back

<b>BS15G</b>	15W Guitar Amp (6.5" spk).....	\$109.00
<b>BS15B</b>	15W Bass Amp (6.5" spk).....	133.00

# AMP STANDS



## STAGELINE

### A-Frame Amplifier/Monitor Stand

This A-frame stand tilts at 70° and will raise cabs from 12" to 19" off the floor. It holds up to 150 lbs., and folds for portability.

**AS5** .....\$60.67



## ULTIMATE

Ultra compact, Three-position tilt Genesis Series amp stand with locking legs and mic boom attachment.

**UAMP150** .....\$50.00B



## QUIK LOK

Double-brace, low profile stand for large amps and combos. Height adjustment – front tier: 8.25" to 11", back tier: 11.4" to 18.6".

**AMSBS317** .....\$66.65



## QUIK LOK HEIGHT ADJUSTABLE MONITOR STAND

Designed for home, project and professional recording studios. Speaker plate dimensions: 9" square. Height positions (5): 32.7", 36", 39", 42", 45.3".

**AMSBS300** .....\$66.65



## QUIK LOK

The AMS-BS-625 features a tilt-back bottom amp platform and a top amp platform. Both platforms have a dual set of durable support arms. Big enough for holding the large size combo amps with up to two 12" speakers.

**AMSBS625** .....\$120.00

## VOX MINI3G2 PORTABLE GUITAR AMPLIFIERS



**MINI3G2BK** Black .....\$155.99B

Eleven built-in authentic amp models distilled from VOX's Valvetronix technology. Wide range of tones from sparkly cleans all the way to high-gain distortion. Usable with a variety of instruments such as electric guitars, acoustic-electric guitars, and keyboards. New Bassilator circuit – delivers a rich low end, especially with high-gain models. Enhanced compressor, chorus, flanger, tremelo, delay and reverb. **Dual power options – use the included AC adaptor or enjoy up to 10 hours of musical portability with six AA batteries.** Dedicated mic input with separate volume and reverb/delay controls – ideal for vocals. AUX input jack – connect your MP3 player or other audio source and jam along. High-performance, built-in E string tuner. Convenient carrying strap is included for true on-the-go mobility. Available in two color choices: chic black, or traditional VOX livery featuring the signature brown diamond grille cloth.



**MINI3G2CL** Vox Livery.....\$155.99B

## BLACKSTAR® AMPS



Innovative 1 watt valve combo. 1xECC83 and 1xECC82. Unique push-pull power amp design. Based on award winning HT-5. Two channels. 8" speaker. Patented Infinite Shape Feature (ISF). Perfect for studio or practice. Speaker emulated output. Stereo MP3/line input. External speaker output.  
**KHT1** Combo .....\$337.40B



Innovative 1 watt valve combo. 1xECC83 and 1xECC82. Unique push-pull power amp design. Based on award winning HT-5. Two channels. 8" speaker. Patented Infinite Shape Feature (ISF). Perfect for studio or practice. Speaker emulated output. Stereo MP3/line input. External speaker output. Stereo reverb.  
**KHT1R** Combo w/Reverb.....\$399.99B

## JOHNSON AMPS



• 10 Watts RMS • 6.5" Speaker • 2 Channels (Clean and Drive) • 1/4" Headphone Jack • Volume, Channel Select Switch, Gain, Treble, Mid and Bass  
**JA010G** Practice Amp .....\$83.45



The RepTone guitar amp series showcases style, power and performance. Each amp is packed in a rugged ozite shell with specially designed metal grill  
• 15 Watts RMS • Overdrive Switch with Gain control  
• 6.5" Speaker • 12.5" x 12.2" x 8.3" at 13.2 lbs.  
**JA015** .....\$142.80



• Black Metal Grille • Spring Reverb • 3-Band EQ • 1/4" Headphone Jack • Footswitch Jack • RepTone 30 Guitar • 30 Watts RMS • 10" Speaker • 11.6" x 15.9" x 17.9" at 23 lbs.  
**JA030R** .....\$215.85



• Black Metal Grille • 3-Band EQ with Presence Control • 1/4" Headphone Jack • **RepTone 15 Bass** • 15 Watts RMS • 6.5" Speaker • 9.7" x 13.5" x 14.6" at 13.2 lbs.  
**JA015B** .....\$142.80



• 30 Watts RMS • 10" Speaker • 15.5" x 13.25" x 10.25" at 20.4 lbs. • Black Metal Grille • 3-Band EQ with Presence Control • 1/4" Headphone Jack.  
**JA030B** .....\$214.55



**Acoustic Amp**  
• 6.25" Woofer & 2.5" Tweeter • 3-Band EQ • Accutronics Reverb • 1/4" and XLR Inputs • Line Out & Headphone Jack • 12.2" x 12.6" at 11.7 lbs.  
**JA015AR** .....\$184.15

## PIGNOSE AMPS



### GUITAR

An ideal practice or first amp. Packed with separate volume, treble and bass controls and headphone jack.

**PG10** .....\$79.95B



### GUITAR

Features Tube Stack™ distortion, master control, 2 band EQ and headphone jack.

**PG20** .....\$117.50B



### BASS

Features volume and master volume, Funk Bass™, separate treble, mid and bass controls and headphone and line out jacks.

**PB30** .....\$170.00B



**PIG** .....\$125.05B

**PIG9V AC Adaptor**.....\$25.00B



8" Speaker. 2 inputs  
3 Band EQ. AC/DC.

**HOG** w/Charger.....\$189.95B

**7200AC** AC Adaptor/Charger .....\$63.00

**HOGBAT** Battery Pack.....\$80.00B



30 watts power output. 8" speaker. Volume, master volume, treble, middle, bass controls. Funk Bass™ switch. Internal rechargeable lead-acid batteries. AC operation with included recharger/adaptor cable. 1 front, 1 rear inputs. Headphone jack on rear panel. Line out jack on rear panel. 6 to 10 hours battery life between charging (during use). 3 to 4 month shelf life between charges. Brown pigskin tolex cover. Suggested uses: bass, keyboard, guitar, vocals, music playback. 14" x 9 1/2" x 17". 28 lbs.

**HOG30** Bass.....\$249.95B

## AMPUPLUG



Mini amp plugs directly into guitar.

**AMP1**.....\$37.85B

## DANELECTRO



### HODAD II

This sweet mini amp packs some serious punch, in a compact but powerful amplifier design. With a battery, you can take it on the road or plug in wherever and whenever inspiration strikes.

**DH2** .....\$39.00\*



### HODAD

Powerful mini amp for practice or back stage tune up • Twin speakers • Cool echo effect • Vintage tremelo with adjustable speed.

**DH1** .....\$59.00\*

## HONEYTONE AMP



Volume, Tone, Overdrive. Available: (A)Aqua, (Y) Yellow, (BU) Burgandy, (BK) Black, (W) White.

**N10** .....\$39.95B

## ON/STAGE



Simply plug the GA5000MI directly into your guitar, plug in your favorite headphones, and rock out in privacy. No cable necessary. Tone and Gain controls let you tailor the sound.

**GA5000MI** .....\$39.99

## MINI AMPS



**FMTM** Fender, Tone Master .....\$63.15

**MD20** Fender, Deluxe.....\$63.15

**4811** Fender, Mini Twin .....\$80.35

\* = CALL FOR DEALER COST



# GALAXY AUDIO

## WIRELESS MONITORS

### AS-900



\*Specify Frequency  
CODE (K1) (K2) (K7) (K8)

Any Spot AS-900 Wireless Personal Monitor is a great entry-level Wireless Personal Monitor. This system features an 80mW receiver output. The receiver also contains an RF and low battery indicator. The transmitter has L/R level display, stereo XLR/1/4" inputs and an headphone output with volume control. Single channel, fixed frequency unit, ear buds and rack ears included.

AS-900.....\$259.99\*  
AS-900-4 Band Pack.....\$859.95\*



\*Specify Frequency  
CODE (D) or (L)

Any Spot AS-1100 Wireless Personal Monitor The AS-1100 packs an amazing punch. The transmitter has stereo XLR/1/4" inputs, headphone output, and LCD display, which displays the channel and input level. The Receiver has an LCD with channel, battery level, and RF/AF indicator. The AS-1100 is perfect for anyone looking for their first system or to upgrade to the next level. 120 selectable channels, ear buds and rack ears included.

AS-1100.....\$559.99\*  
AS-1100-4.....\$1469.95\*

## WIRELESS MICROPHONES

### VHF



Single channel VHF wireless Microphone systems VES and Diversity VSC. Both constructed with durable plastic housing that will endure the practice room, or the stage. The 1/4" output connects easily to any mixer board, and the front mounted volume allows for easy adjustment in the middle of the performance. The Receiver has LED Power, RF, and Audio indicators on the front, as well as a squelch adjustment on the rear of the unit.

VESR/HH18 Handheld System.....\$114.99\*  
VESR/318 Body Pack Triple Play System.....\$114.99\*  
VSC/HH18 Handheld System.....\$139.99\*  
VSCR/318 Body Pack Triple Play System.....\$139.99\*

\*Frequencies (CODE V54 173.8 MHZ) (CODE V60 174.5 MHZ)  
(CODE V59 174.1 MHZ) (CODE V61 174.8 MHZ)

### ECD



The ECD Series is a dual channel wireless system. The ECD features 2 internal antennas (1 for each receiver), 16 selectable channels on each receiver, and IR Sync from receiver to transmitter. The ECD has one 1/4" output on the back of the unit. The output is controlled by a volume control for each receiver, located on the front of the unit.

ECDR/HH38 Dual Handheld system.....\$449.97\*  
ECDR/HHBP Handhelds plus Body Pack System (choose headset or lav).....\$309.99\*  
ECDR/38 Dual Body Pack system (choose headset or lav).....\$309.99\*

\*Frequencies (CODE L 655-679 MHZ)  
(CODE D 548-607 MHZ)

## HOT SPOTS

### PA6S



### HS7



200 Watt Passive Version

### MS5



Stand mount included with MS5

PA6S Compact PA System. The PA6S features a 170 watt power amplifier, two way speaker system; 155 watt NEOLITE 6.5" Woofer, 1.5" 60 watt Titanium Dome Tweeter, two XLR/ 1/4" inputs with XLR pass through, built in compressor, line input, line output, three band EQ, built in mic stand mount, mic boom socket, Integrated handle, built in stand/wall bracket mounts (optional bracket). The PA6S is great for any live sound application whether it's used as a front of house compact PA speaker or a personal monitor. The PA6S sounds better, gets louder, and weighs less, all for the same price of its predecessor. Frequency Response (80HZ - 18kHz) weighs 6.4 lbs, 7.75" x 11.75" x 6.75".

PA6S Powered Monitor 155 Watt.....\$399.95\*  
HS7 Passive Monitor 200 Watt.....\$199.99\*  
MS5 Micro Spot Passive Monitor 100 Watt.....\$109.99\*  
MSA1 Aluminum Stand Adaptor.....\$9.99\*  
SAYB10 HS7, PA6S/R Wall Mount Yoke & Bracket BLACK.....\$29.99\*  
S5N-8 Replacement 5" Neolite Speaker.....\$59.00\*

## WIRELESS HEADSET MICS



Many Any Spot Headset Mics are available with either Omni-directional (O) or Uni-directional (U) elements. The Omni has a frequency response of 20Hz - 20kHz and the Uni has a response of 70Hz - 16kHz. Mics are available in Black (BK) Beige (BG) and Cocoa (CC). Equipped with Easy Replace Cable and can be mated with most all popular wireless manufacturer's connections. One cable of your choice included.

### ES3 Single Ear

ES3-OBG Omni Beige.....\$149.99\*  
ES3-OBK Omni Black.....\$149.99\*

### HS3 Dual Hook Wraps Around Head

HS3-OBG Omni Beige.....\$149.99\*  
HS3-OBK Omni Black.....\$149.99\*

### HSE Single Ear

HSE-OBG Omni Beige.....\$299.99\*  
HSE-OBK Omni Black.....\$299.99\*  
HSE-OCC Omni Cocoa.....\$299.99\*

### HSE-UBG Uni Beige.....\$299.99\*

HSE-UBK Uni Black.....\$299.99\*  
HSE-UCC Uni Cocoa.....\$299.99\*

### HSD Dual Ear Hook

HSD-OBG Omni Beige.....\$299.99\*  
HSD-OBK Omni Black.....\$299.99\*  
HSD-OCC Omni Cocoa.....\$299.99\*

### HSD-UBG Uni Beige.....\$299.99\*

HSD-UBK Uni Black.....\$299.99\*  
HSD-UCC Uni Cocoa.....\$299.99\*

Cable choices \*\*being color BG (Beige), BK (Black), or CC (cocoa)  
CBLSHU\*\* TA4F wired for most Shure systems  
CBLAT\*\* HIROSE 4 pin wired for most AT systems  
CBLSEN\*\* 3.5mm locking wired for most Sennheiser systems  
CBLAKG\*\* TA3F wired for most AKG systems  
CBL25MM\*\* 2.5mm wired for Galaxy adaptors

# CASIO



Mini-size keyboard: 44 Mini-size keys, 100 Tones, 50 Rhythms, 10 Songs, LCD, 5 Drum pads, piano/organ switch. **Operates on 6 AA batteries or optional ADE95100 adapter.**

**SA76**.....\$69.99\*



Lighted keys keyboard; 61 piano-style lighted keys, 48 note polyphony, 400 tones, 150 rhythms, 110 songs, LCD display, sampling function, digital effects, step-up lesson system, mic jack with volume control, MIDI. **Operates on 6 AA batteries or included ADE95100 adapter.**

**LK165** .....\$199.99\*



Lighted keys keyboard: 61 Piano-style lighted keys, 48-Note polyphony, 400 Tones, 110 Songs, 150 Rhythms, Mic jack with volume control for sing along, LCD display, USB MIDI, VoicePad sample playback buttons. **Operates on 6 AA batteries or included ADE95100 adapter.**

**LK240** .....\$259.99\*



Lighted keys keyboard; 61 piano-style lighted, touch sensitive keys, 48 note polyphony, 600 tones, 180 rhythms, 152 songs, LCD display, step-up lesson system, mic jack with volume control, USB MIDI, SDHC card slot, 5 song 6 track recording, digital effects. **Operates on 6 AA batteries or included ADE95100 adapter.**

**LK280** .....\$299.99\*



Standard keyboard: 61 Piano-style keys, 48-note polyphony, 400 Tones, 110 Songs, 150 Rhythms, LCD display, USB MIDI, VoicePad sample playback buttons. **Operates on 6 AA batteries or included ADE95100 adapter.**

**CTK2300**.....\$169.99\*



Standard keyboard; 61 piano-style keys, touch sensitive, 48 note polyphony, 400 tones, 150 rhythms, 110 songs, digital effects, USB MIDI, pitch bend wheel. **Operates on 6 AA batteries or included ADE95100 adapter.**

**CTK3200**.....\$199.99\*



Standard keyboard, 61 piano-style keys, 48 note polyphony, touch sensitive, 600 tones, 180 rhythms, 152 songs, 5 song 6 track recorder. Digital effects, step up lesson system, USB MIDI, backlit LCD display. **Operates on 6 AA batteries or included ADE95100 adapter.**

**CTK4200**.....\$259.99\*



Standard keyboard, 61 piano-style keys, 48 note polyphony, 700 tones, 210 rhythms, digital effects, 16 track song sequencer, rhythm editor, 32 channel mixer, 4 set x 8 bank registration memory, 5 EQ settings, backlit LCD, touch sensitive, USB MIDI, pitch bend wheel, SD card slot, line out. Sustain/assignable pedal jack, 6W + 6W amplifier. **Operates on 6 D batteries or included ADA12150 adapter.**

**CTK6200**.....\$299.99\*



Workstation, 76 piano-style touch sensitive keys, 48 note polyphony, 600 tones, 180 rhythms, 32 registration memory, 152 songs, USB MIDI, 5 song / 6 track recording, sampling, step-up lesson system, mic with volume control & audio in jacks, digital effects. **Operates on 6 DD batteries or included ADE95100 adapter.**

**WK225** .....\$299.99\*



Workstation keyboard, 76 piano-style keys, 48 note polyphony, 700 tones, 210 rhythms, digital effects, 16 track song sequencer, rhythm editor, 32 channel mixer, 4 set x 8 bank registration memory, 5 EQ settings, backlit LCD, touch sensitive, USB MIDI, pitch bend wheel, SD card slot, line out. Sustain/assignable pedal jack, 6W + 6W amplifier. **Operates on 6 D batteries or included ADA12150 adapter.**

**WK6600**.....\$449.99\*



Workstation keyboard, 76 piano-style keys, stereo audio recording, 9 sliders with organ drawbar mode, 64 note polyphony, 820 tones, 260 rhythms, 5 EQ settings, digital effects, 8 track editing x 6 pattern sequencer, 50 drawbar organ tones, 16 track song sequencer, 32 channel mixer, 6 set x 16 bank registration memory, 250 one touch presets, 9 sliders, backlit LCD, touch sensitive, USB MIDI, pitch bend wheel, SD card slot, line out. Sustain/assignable pedal jack, 7W + 7W amplifier. **Operates on 6 D batteries or included ADA12150 adapter.**

**WK7600**.....\$799.99\*



Digital Cabinet Piano in brown finish: 88 full size weighted, scaled hammer action ebony and ivory touch keys, AIR sound source, 4 layer stereo grand piano sound. Touch Response, hammer response & damper resonance simulation. 128-note polyphony, 16 tones, 60 built-in & 10 user songs, 2 track/1 song recorder, duet mode, USB to host connection, 3 pedals, 2x8W amplifier, folding slide-type keyboard cover. Includes matching bench. **Operates with included ADA12150 adapter.**

**AP250BN**.....\$1399.99\*

\* = CALL OR WRITE FOR DEALER COST.

# CASIO



Portable Digital Piano available in black or white: 88 full-size weighted scaled hammer action tri-sensor keys, 4 layer stereo grand piano sound, ebony and ivory feel keys, multi-dimensional morphing AIR sound source, hammer response and damper resonance simulator, 128-note polyphony, 18 tones, 60 songs, USB MIDI, duet mode, 2 track/1 song recorder, 2 x 8W amplifier. **Operates with included ADA12150 adapter.**  
**PX150BK.....\$899.99\***



Digital console piano available in black, brown or white: 88 full-size weighted scaled hammer action tri-sensor keys, 4 layer stereo grand piano sound, ebony & ivory feel keys, multi-dimensional morphing AIR sound source, hammer response and damper resonance simulator, multi-position piano lid, 256 note polyphony, 18 tones, 2 track/1 song recorder, 60 built-in songs, USB MIDI, duet mode, 4 speaker/2x20W amplifier. Includes stand, three pedal board & folding keyboard cover. **Operates with included ADE24250 adapter.**  
**PX850BK.....\$1499.99\***



Standard keyboard: 61 piano-style keys, 54 oriental tones, 83 oriental/Arabic rhythms, oriental scale tuning. Stereo audio recording, 64 note polyphony, 800 tones, 250 rhythms, digital effects, 16 track song sequencer, 32 channel mixer, pattern sequencer, 6 set x 16 bank registration memory, 250 one touch presents, backlit LCD, touch sensitive, USB MIDI, pitch bend wheel, SD card slot, line out, sustain/assignable pedal jack, 7W + 7W amplifier. **Operates on 6 D batteries or included ADA12150 adapter.**  
**AT3.....\$599.99\***



Workstation keyboard: 76 piano-style keys, 54 oriental tones, 83 oriental/Arabic rhythms, oriental scale tuning, stereo audio recording, 64 note polyphony, 800 tones, 250 rhythms, digital effects, 8 track editing and 6 pattern sequencer, 16 track song sequencer, 32 channel mixer, 6 set x 16 bank registration memory, 250 one touch presets, backlit LCD, touch sensitive, USB MIDI, pitch bend wheel, SD card slot, line out, sustain/assignable pedal jack, 7W + 7W amplifier. **Operates on 6 D batteries or included ADA12150 adapter.**  
**AT5.....\$799.99\***



Performance synthesizer, 6 oscillator monophonic solo synth, HexLayers, drawbar organ w/9 sliders, 400 editable PCM sounds, step sequencer (9+ 4 tracks), 16 step arpeggiator, phrase sequencer, performance mode w/4 instrument zones, 4 controller knobs, pitch and mod wheels, 1/4" mic and line inputs, stereo 1/8" input, USB & MIDI ports, 1/4" line outputs. **Operates on 6 D batteries or included ADE95100 AC adapter.**  
**XWP1.....\$799.99\***



Portable Digital Piano available in black or white: 88 full-size weighted scaled hammer action tri-sensor keys, 4 layer stereo grand piano sound, ebony and ivory feel keys, multi-dimensional morphing AIR sound source, hammer response and damper resonance simulator, 128-note polyphony, 250 tones, 180 rhythms, 17 track/5 song recorder, registration memory, backlit LCD display, pitch bend wheel, USB MIDI, duet mode, 2 x 8W amplifier. **Operates with included ADA12150 adapter.**  
**PX350BK.....\$1099.99\***



## ACCESSORIES

**PS25** Sustain, Switchable.....**\$19.99**  
**VP26** Volume Pedal (Casio, Korg).....**46.65**  
**YFC5** Yamaha Sustain Switch.....**24.00**  
**WTB004** Sustain, Switchable.....**21.95**  
**KSP20** Sustain, Switchable (On/Stage).**24.99**

## PIANO STYLE PEDALS

**YFC3** Yamaha Dual Zone Sustain.....**\$70.00**  
**YFC4** Yamaha Sustain Pedal.....**46.65**  
**KSP100** Sustain Pedal, Switchable (On/Stage).....**44.99**  
**VFP110** Sustain (Casio).....**36.95**  
**VFP115** Sustain (Roland, Yamaha).....**36.95**  
**VFP125** Switchable Polarity.....**48.35**  
**PSP125** Switchable Polarity.....**39.99**  
**VFP210** DBL Switch (Casio).....**86.60**  
**SP33** Three pedal board for PX150BK/150WE/350BK/350WE. Requires CS67 stand.....**99.99\***

**CASIO SP20** Casio Sustain.....**39.99\***

## OPTIONAL ACCESSORIES – ADAPTERS, STANDS, PEDALS, CASES

**ADE95100** 9.5V Adapter for SA76, LK165/240/280, CTK 240/2300/3200/4200, WK225, XWP1/G1.....**\$39.99\***  
**AD12M3** 12V Adapter for CTK5000, WK500/3300/3800, CDP100/200, PX120/320/575/720.....**39.99\***  
**ADA12150** 12V Adapter for PX3/5/130/150/330/350/730/750, AP220/250, CDP120/220, CTK6000/6200/7000/7200, WK6500/6600/7500/7600.....**39.99\***  
**ARBENCH** Folding Keyboard Bench (250 lb. capacity).....**39.99\***  
**ARST** Standard "X" style stand for LK/CTK/WK models.....**29.99\***  
**ARDX** Deluxe "XX" design keyboard stand for LK/CTK/WK models.....**39.99\***  
**CS67** Black Stand for PX3/5/130/150BK/330/350BK.....**39.99\***  
**SP33** Three pedal board for PX150BK/150WE/350BK/350WE. Requires CS67 stand.....**99.99\***  
**SP3R** Sustain pedal for LK/CTK/WK.....**24.99\***  
**CASIO SP20** A piano-style sustain pedal for all Casio keyboards and digital pianos with pedal jacks.....**39.99\***  
**PRIVICASE** Carrying case for Privia PX3/5/120/130/150/320/330/350.....**39.99\***

\* = CALL FOR PRICING



Standard keyboard, 61 piano-style keys, stereo audio recording, 9 sliders with organ drawbar mode, 64 note polyphony, 820 tones, 260 rhythms, 5 EQ settings, digital effects, 16 track song sequencer, 32 channel mixer, 8 track editing x 6 pattern song sequencer, 6 set x 16 bank registration memory, 250 one touch presents. Backlit LCD, touch sensitive, USB MIDI, pitch bend wheel, SD card slot, line out. Sustain/assignable pedal jack, 7W + 7W amplifier. **Operates on 6 D batteries or included AD-A12150 adapter.**  
**CTK7200.....\$599.99\***



Black digital console piano: 88 full-size weighted scaled hammer action tri-sensor keys, 4 layer stereo grand piano sound, ebony & ivory feel keys, multi-dimensional morphing AIR sound source, hammer response & damper resonance simulator, 128 note polyphony, 250 tones, 180 rhythms, 17 track/5 song recorder, 60 built-in songs, USB MIDI, USB flash port, back lit LCD display. Pitch bend wheel, duet mode, 20 + 20W amplifier w/4 speakers. Includes stand, three pedal board & folding keyboard cover. **Operates with included ADA12150 adapter.**  
**PX780BK.....\$1399.99\***



Professional digital stage piano: 88 full size weighted scaled hammer action, ebony & ivory feel keys, multi-dimensional morphing AIR sound source, 256 note polyphony, 370 pre-set & 350 user tones, 100 user stage settings w/4 zone configurations, 4 simultaneous arpeggiators, 8 track sequencer, controllers (4 knobs, 6 sliders, pitch & mod wheels, 2 pedal inputs). 60 preset & 50 user instruments, numerous system & insert effects, 4 band EQ & compressor, 50 preset & 150 user hexlayers, independent USB & MIDI I/O, USB slot for file/audio recording, 24 lbs. no amplifier/speakers. **Operates with include ADA12150 AC adapter or optional AA batteries.**  
**PX55.....\$1399.99\***



Groove synthesizer, 6 oscillator monophonic solo synth, 19 second sample looper, 10 user tone sample player w/5 samples stored in Flash memory, 300 fully editable PCM sounds, step sequencer (9+ 4 tracks), 16 step arpeggiator, phrase sequencer, performance mode w/4 instrument zones, 4 controller knobs, pitch and mod wheels, 2" mic and line inputs, stereo 1/8" input, USB & MIDI ports, 1/4" line outputs. **Operates on 6 D batteries or included ADE95100 AC adapter.**  
**XWG1.....\$899.99\***

# YAMAHA



The 61 full-sized keys features great onboard content with 385 high-quality instrument voices and 100 musical styles. The ultra-wide stereo effect creates a stereo image that feels wider than the speakers. Built-in lesson functions help you learn how to play at your own pace. Finally, USB TO HOST lets you get connected to Yamaha's wide variety of music apps for iPhone/iPad/iPod touch (requires optional IUX1 interface) or computer to enhance and expand your keyboard experience. • Yamaha Education Suite (Y.E.S.) • Master EQ • Portable Grand • 32-note polyphony • XG Lite compatibility. • **Power: 6 AA batteries or optional PA130 power adapter • Optional Survival Kit (YSKB2)**  
**PSRE243 .....\$169.00\***



61 touch-sensitive, full-sized keys • Ultra-wide stereo • Yamaha Education Suite (Y.E.S.) • iPad/iPhone connectivity • AUX line input • Melody suppressor • 32-note polyphony • 2-track song recorder • XG Lite compatibility • Works with free Sound Controller App (requires i-UX1) • Touch response • Amber backlit LCD • 550 total voices (187 panel voices, 18 drum/SFX kits, 345 XGlite voices) • SFX kit • 136 preset + external songs • 102 preset songs, 5 user songs, 2 user tracks per song • Harmony, registration memory, melody suppressor, dual voice mode, split voice mode • AUX in, headphone jack, sustain pedal jack, USB to host. **Power: 6 AA batteries or optional PA130 power adapter • Optional Survival Kit (YSKB2)**  
**PSRE343 .....\$269.99\***



Keyboard with 61 touch-sensitive keys with guide lights • interactive education suite: learn to play by following the lights • Chord dictionary lights the way for learning chords • 367 general MIDI (GM) and XGlite compatible voices: internet ready • Portable Grand: industry's best piano • 100 internal songs with song book • 9 digital reverb effects • Real stereo: not just two speakers • "One Touch" settings: automatic setup • MIDI in/out: connect to your computer • 32-note polyphony • 100 preset styles with two variations each • Multi finger auto accompaniment • LCD • Headphone jack • Sustain pedal jack • Music rest • **Power: 6 AA batteries or optional PA130 power adapter • Optional Survival Kit (YSKB2)**  
**EZ220 .....\$299.00B**



6Sequencer yes: 6-track recorder (5 linear + 1 chord) • 61 full size keys, touch sensitive • USB to device • MIDI USB to host • backlit LCD • control knobs: (2) pitch bend • effects: reverb/chorus/master EQ • voices & comp: 731/XGLite/GM/GM2 • Harmony: 26 types • Special voices: Sweet (5) / Cool (5) / Arpeggio (40) • Dual/split: yes/yes • Y.E.S. / Lessons: 5 types: expanded Yamaha Education Suite • Headphonejack • Sustain pedal jack • 32-Note polyphony • Music rest • Speakers: (12cm+3cm) x 2 • One Touch/Reg: yes/4 x 8 banks • Style sections: intro/ending/main\*2/Fill • Styles 186 + 10 DJ Patterns • Amplifier: 2.5W x2 • Music Database: 305 • Songs: 100 preset/10 user. **Power: 6 AA batteries or optional PA130 power adapter • Optional Survival Kit (YSKB2)**  
**PSRE433 .....\$429.99\***



76 piano-style keys with Graded Soft Touch (GST) action • 6-track sequencer • 5 types preset Master EQ • Pitch bend wheel • Expandable Music Database: • Easy Song Arranger • USB & PC button • 489 XGLite/GM Voices • Dual and split mode • 160 Styles • 32-note polyphony • 30 internal songs, 70 additional titles on CD-ROM • Backlit display & panel lights • Two-way stereo speakers with bass ports • Sustain pedal & headphone jacks • Music rest • **Power: 6 D batteries or optional PA150 power adapter • Optional Survival Kit (YSKD2).**  
**YPG235 .....\$519.00\***



88 piano-style keys with Graded Soft Touch (GST) action • Live! Grand Piano stereo sample • Score and lyric display • **Stand, sustain pedal and PA150 adapter included** • USB storage, USB MIDI & PC button • 5 types Master EQ • 500 XGLite/GM Voices: 8 Sweet!, 3 Live! & 5 Cool! • 32-note polyphony • 160 Styles plus User Styles • 30 internal songs, 70 additional titles on CD-ROM • Backlit display and panel lights • Pitch bend wheel • 6-track sequencer • Two-way stereo speaker system with bass ports • Music rest.  
**YPG335 .....\$799.99\***



New design is more drummer friendly • AUX IN to play along with an MP3 player • MIDI In/Out • "Hand Play" sensitivity: play Latin kit with hands • Bass port • 4 large and 4 small touch-sensitive drum pads • 230 GM compatible Voices plus 20 drum phrases • Stereo drum kit • 32-note polyphony • Reverb • Master EQ on/off • LED • 50 preset drum kits plus 3 custom kits • Recording capability up to 5 User songs in memory at one time • Intros/endings • Break fill • Stereo speakers • Tap start • Tempo control • 100 songs plus Flash ROM for downloading new songs from the Internet with A-B repeat and part mute • Metronome • Two foot switches (included) and kick drum foot switch is touch-sensitive • **Drum sticks (included) • Headphone jack • Power: 6 C batteries or optional PA150 power adapter • Optional Survival Kit (YSKC2)**  
**DD65 .....\$319.00\***



PA130 power adapter • Stereo headphones • Foot switch • Yamaha Survival Kit DVD-ROM. *Designed specifically for the PSR-E223 • PSR-E323 • PSR-E413 • EZ-200 • EZ-AG.*  
**YSKB2 .....\$49.99\***

PA150 power adapter • Stereo headphones • Foot switch • Yamaha Survival Kit DVD-ROM. *Designed specifically for the YPG-235.*  
**YSKD2 .....\$49.99\***

PA150 power adapter • Stereo headphones • Yamaha Survival Kit DVD-ROM. *Designed specifically for the DD-65.*  
**YSKC2 .....\$49.99\***

**YLP7** 3 Pedal Unit for YPG635 .....**\$89.99\***  
 Equipped with a newly developed crossed XY stereo microphone, the PR7 captures high-resolution stereo recordings. The PR7 offers essential practice functions such as an onboard tuner and metronome, as well as powerful recording functions.  
**YPR7 .....\$249.99B**

\* = CALL FOR DEALER COST

## KACES KEYBOARD PORTERS



### XPRESS SERIES PORTERS (w/wheels)

Semi-Rigid Cases with Wheels

<b>XKP9KB</b>	61-Key Large	44.5"	17"	6.5"	<b>\$186.90</b>
<b>XKP11KB</b>	76 Key	51"	17.5"	6.5"	<b>203.15</b>
<b>XKP14KB</b>	88-Key Large	59"	18.75"	7"	<b>211.25</b>

## SKB KEYBOARD CASES



<b>1R4417W</b>	ATA 61 Note Case w/wheels	<b>\$623.99</b>
<b>1R6218W</b>	ATA 88 Note Narrow Case w/wheels	<b>899.99</b>
<b>1R6223W</b>	ATA 88 Note Large Case w/wheels	<b>997.99</b>
<b>SKB4214W</b>	61 Note w/wheels	<b>449.99</b>
<b>SKB5014W</b>	76 Note w/Wheels	<b>584.99</b>
<b>SKB5817W</b>	88 Note Slim, w/wheels	<b>764.99</b>
<b>SKB6118W</b>	88 Note w/wheels, Large	<b>919.99</b>
<b>SKBR4215W</b>	61 Note w/wheels, <b>Roto molded</b>	<b>429.99</b>
<b>SKBR5220W</b>	76 Note w/wheels, <b>Roto molded</b>	<b>454.99</b>
<b>SKBR6020W</b>	88 Note w/wheels, <b>Roto molded</b>	<b>501.99</b>
<b>313614KBD</b>	<b>Injection Molded</b> 49-Note Keyboard Case 34" x 13½" x 4½"	<b>314.99</b>
<b>314214KBD</b>	<b>Injection Molded</b> 61-Note Narrow Keyboard Case 340" x 13½" x 4"	<b>364.99</b>
<b>314217KBD</b>	<b>Injection Molded</b> 61-Note Keyboard Case 40" x 16" x 5"	<b>389.99</b>
<b>315014KBD</b>	<b>Injection Molded</b> 76-Note Narrow Keyboard Case 48" x 13½" x 4½"	<b>404.99</b>

## KACES BAGS



### XPRESS KEYBOARD BAGS

<b>5KB</b>	35.5"	12.75"	5"	<b>\$71.55</b>
<b>6KB</b>	37"	15"	6.5"	<b>80.55</b>
<b>7KB</b>	42.25"	14.625"	5.25"	<b>80.55</b>
<b>8KB</b>	48.625"	14.125"	5.5"	<b>91.45</b>
<b>9KB</b>	44.5"	17"	6.5"	<b>94.80</b>
<b>11KB</b>	51"	17.5"	6.5"	<b>107.20</b>
<b>13KB</b>	38.75"	16.5"	6.5"	<b>82.80</b>
<b>15KB</b>	54.5"	14.5"	5.25"	<b>100.45</b>

## KEYBOARD BAGS/COVERS



### KACES STRETCHY DUST COVERS

<b>KKCSM</b>	49-61 Note	<b>\$21.50</b>
<b>KKCMD</b>	61-76 Note	<b>25.10</b>
<b>KKCLG</b>	76-88 Note	<b>28.70</b>

### YAMAHA KEYBOARD BAGS

<b>YYBA881</b>	61" x 21.5"	<b>\$69.99</b>
<b>YYBA761</b>	53" x 21"	<b>64.99</b>
<b>YYBA611</b>	43.725" x 20"	<b>54.99</b>

## SKB KEYBOARD SOFT CASES



### SKB KEYBOARD SOFT CASES W/WHEELS

<b>SKBSC61KW</b>	61-Note Keyboards	44.5"	16.5"	5.3"	<b>\$273.99</b>
<b>SKBSC61AKW</b>	60-Note Arranger Keyboards	51.5"	19.5"	7.2"	<b>352.99</b>
<b>SKBSC76KW</b>	76-Note Keyboard	52.5"	16.4"	6.4"	<b>315.99</b>
<b>SKBSC88KW</b>	88-Note Keyboard	58.5"	20.5"	6.5"	<b>367.99</b>
<b>SKBSC88NKW</b>	88-Note Keyboard	57.5"	15.5"	6.4"	<b>345.99</b>

### CORDURA NYLON

<b>CK40049</b>	36" x 14" x 5" (49)	<b>\$51.75</b>
<b>CK40061</b>	42½" x 15" x 6½" (61)	<b>58.05</b>
<b>CK40076</b>	50" x 15" x 6" (76)	<b>60.65</b>
<b>CK40088</b>	58" x 20" x 5½" (88)	<b>71.50</b>



### ON/STAGE DUST COVERS

Dust Free Spandex	
<b>KDA7061B</b>	61-76 Keyboard Dust Cover, Black <b>\$29.99</b>
<b>KDA7088B</b>	88 Key Keyboard Dust Cover, Black <b>29.99</b>

### KEYWEAR DUST COVERS

Black Spandex Dust Covers	
<b>KWS</b>	Small Keyboards <b>\$29.95B</b>
<b>KWM</b>	61/76 Keyboards <b>29.95B</b>
<b>KWL</b>	76/88 Keyboards <b>34.95B</b>



### WINDSOR KEYBOARD BAGS

<b>WKB41</b>	41¼" x 14½" x 5"	<b>\$60.30</b>
<b>WKB42</b>	42¼" x 14¾" x 5¼"	<b>60.30</b>
<b>WKB44</b>	44½" x 17" x 6½"	<b>73.50</b>
<b>WKB51</b>	51" x 17½" x 6½"	<b>73.50</b>

## KEYBOARD BENCHES



SLPBK10

### WOOD PIANO BENCHES, PADDED, WITH MUSIC COMPARTMENT

Quality bench at an amazing price! Adjustable from 18" to 21.5". Plush seat, 21.75" x 13.5" x 18".

**SLPBK10** Plush Padded Piano Bench.....\$277.25

Faux leather seat with generous padding, wood frame, rubber feet, black or brown finish, 22" x 12.2" x 21.5".

**BP090BK** w/o Compartment (BK) Black.....\$172.85

**BP090BR** Standard (BR) Brown, w/o Compartment.....172.85

Sheet music storage. Adjustable from 18" to 21.5". Duet size, deluxe seat, 29.5" x 13.5" x 18".

**SLPBK12** Duet Padded Piano Bench.....\$316.15

### GRK WOOD BENCH WITH COMPARTMENT, PADDED BENCH

**PB46** (E) Ebony, (W) Walnut, (M) Mahogany.....\$131.45B

### WOOD FRAME PIANO BENCHES

Faux leather seat, wood frame, music compartment, adjustable height, black or brown finish, 22" x 13.4" x 18.5"-22".

**BP120BK** Adjustable, Deluxe Black.....\$290.50

**BP120BR** Adjustable, Deluxe Brown.....290.50



KB45

### X STYLE TUBULAR BENCHES

**KB40** Stageline, Height 16" to 19.75", Seat 12.5" x 17".....\$35.99

**KB45** Stageline, Height 17" to 23", Seat 11" x 22".....79.99

**YPKBB1** Yamaha.....50.00

**KM14065B**.....112.99

**BP010BK** Height 16" x 24".....38.10

**KB200B** 4 Position, EZ Micro Adjust.....178.99

**AMSBX8** Height 18" x 22".....66.65

**SLKB51** Height from 20.875" to 26". Seat 12.5" x 23.75".  
4 position deluxe.....66.00

**KT7800** Three-Position X-Style Bench, On/Stage.....65.99

**KT7800+** Deluxe X-Style Bench, On/Stage.....85.99

**KB8902B** Flip-Top Bench, Black, On/Stage.....149.99



KT708



DT8500

### KEYBOARD THRONES

**KT708** Backrest Throne.....\$235.45B

**AMSDX749** Height Adjustable with adjustable footrest and back rest....199.99

### GUITAR/KEYBOARD THRONE

**DT8500** On/Stage.....\$145.99

The height adjustable seat allows for a comfortable playing position. Both seat and backrest are padded.

## KEYBOARD STANDS



ARDX



KS11



KM1894

<b>ARST</b>	X Type, Casio.....	\$29.99*
<b>ARDX</b>	X Type, Double Braced Casio.....	39.99*
<b>KB860K</b>	Single X Type Hamilton.....	39.99
<b>KB865K</b>	Double X Type Hamilton.....	54.99
<b>KS110B</b>	X Type, Hercules.....	94.99
<b>KS120B</b>	X Type, Double Braced, Hercules.....	110.99
<b>KS210B</b>	Double Tier X Keyboard Stand.....	169.99
<b>KBT442</b>	X Type, Hosa.....	35.25
<b>YPKBS1</b>	X Type Yamaha.....	30.00
<b>YL3C</b>	Attachable Yamaha.....	47.50B
<b>YPKBZ1</b>	Z-Style, Adjustable Width, Yamaha.....	65.00B
<b>KS25Q</b>	Black Finish, X Type, Stageline.....	43.15
<b>KS26Q</b>	X Type, Double Braced, Stageline.....	57.10
<b>TT45</b>	X Type Single Black.....	47.20

### ADJUSTABLE WIDTH & HEIGHT FOLDING STAND

**KS11** Stageline.....\$99.99B

### K&M

**KM1894** Quick Release.....\$104.99

**KM18962B** X Type.....55.00

**KM18969** Keyboard Stand for Kids.....59.99

## ON/STAGE

### KEYBOARD STANDS

**KS7190** Classic Single-X Keyboard Stand.....\$43.99

**KS7191** Classic Double-X Keyboard Stand.....62.99

**KS8190** Lok-Tight Classic Single-X.....54.99

**KS8191** Lok-Tight Classic Double-X.....65.99

**KS8390** Lok-Tight Single-X w/quikSQUEEZE trigger.....52.99

**KS8391** Lok-Tight Double-X w/quikSQUEEZE trigger.....72.99

**KS8291** Lok-Tight Pro Double-X ERGO-LOK™.....109.99

**KS7291** Pro Heavy-Duty Double-X ERGO-LOK™.....126.99

**KS7150** Platform Style Keyboard Stand.....149.99

**KS7350** Pro Heavy-Duty Folding-Z.....169.99

**KS7903** 3-Tier A-Frame Keyboard Stand.....209.99

**KSA7500** Universal 2nd Tier / Mounting: 1" or 30mm round  
or square tubing.....65.99

**LPT5000** Computer Laptop Stand.....54.99

**LPT6000** Multi-Purpose Laptop Stand.....84.99

## QUIK LOK KEYBOARD STANDS



**AMST10** Single X.....\$53.32

**AMST20** Double X.....66.65

**AMST22** Double Tier, Double Braced.....106.65

**AMST500** Heavy Duty X Style w/Trigger.....133.32



# ULTIMATE SUPPORT



## HYPERSTATION SERIES

Portable two-tier laptop and DJ stand with adjustable support arms. Height: 13.75", base dims (WxD): 12" x 10.5". Arms width: 10.5". Arm depth: 8.75" - 12". Arm weight limit: 10 lbs. Shelf dims: (WxD) 8" x 9". Folded dims (HxWxD): 2.5" x 12" x 13.25". Weight: 9 lbs.

<b>ULPT1000B</b>	Black Hyperstation.....	<b>\$199.99B</b>
<b>ULPT1000R</b>	Red Hyperstation.....	<b>199.99B</b>
<b>ULPT1000S</b>	Silver Hyperstation.....	<b>199.99B</b>



## APEX KEYBOARD STANDS AND ACCESSORIES

<b>UAX48PRO</b>	Apex Column.....	<b>\$249.99*</b>
<b>UAX48PROS</b>	Apex Column in Silver.....	<b>249.99B</b>
<b>UAX48PRO+</b>	Apex Plus Column w/Mic Boom Bag.....	<b>299.99*</b>
<b>UAXBAG</b>	Apex/Deltex Tote Bag.....	<b>49.99*</b>
<b>UAXB00M</b>	Apex MicBoom w/Adapter.....	<b>69.99B</b>
<b>UCMP485</b>	Apex Super Clamp.....	<b>49.99B</b>
<b>2UTBR130</b>	Apex Standard Tribar - 13" (Pair).....	<b>50.99</b>
<b>2UTBR180</b>	Apex Long Tribar - 18" (Pair).....	<b>59.99</b>



## V-STAND PRO AND ACCESSORIES

Extraordinarily versatile - use in sitting or standing position! Incredibly portable - folds up into a compact 19" x 9.5" x 6" space. Heavy load capacity - great for workstations, large mixers, heavy piano slabs and DJ equipment. Surprisingly light and sturdy - designed and manufactured from aluminum.

<b>UVS88B</b>	V-Stand for Professionals - Black.....	<b>\$249.99B</b>
<b>USHVS88</b>	V-Stand Shelf w/Clamp.....	<b>69.99B</b>
<b>UBAGVS88</b>	V-Stand Tote Bag.....	<b>54.99B</b>



## IQ X-STYLE KEYBOARD STANDS AND IQ TWO-TIER X-STYLE KEYBOARD STANDS

With patented memory lock system, five height settings, stabilizing end caps.

<b>UIQ3000</b>	IQ-3000 Double-Brace X-Stand.....	<b>\$149.99B</b>
<b>UIQ1000</b>	Single Brace X-Stand.....	<b>69.99B</b>
<b>UIQ1200</b>	Single braced X-style 2 tiered keyboards stand.....	<b>89.99B</b>
<b>UIQ2000</b>	Double Brace X-Stand.....	<b>89.99B</b>
<b>UIQ2200</b>	Double braced X-style 2 tiered keyboard stand.....	<b>129.99</b>
<b>UIQ200</b>	2nd Tier for IQ-1000/IQ-2000.....	<b>49.99B</b>



## SPEAKER STANDS LIGHTING TREE CROSSBARS AND EXTENSION

<b>UTS100B</b>	Air Lift Speaker Stand.....	<b>\$219.99B</b>
<b>UTS90B</b>	TeleLock Speaker Stand.....	<b>149.99B</b>
<b>UTS99B</b>	Tall TeleLock Stand.....	<b>199.99B</b>
<b>UTS99BL</b>	Tall TeleLock Stand w/Leveling Leg.....	<b>229.99B</b>
<b>UTS80B</b>	Original Speaker Stand, Black.....	<b>129.99B</b>
<b>UTS80S</b>	Original Speaker Stand, Silver.....	<b>129.99B</b>
<b>UTS88B</b>	Tall Original Stand.....	<b>169.99B</b>
<b>UTS70B</b>	Speaker Stand.....	<b>79.99B</b>
<b>UBMB200K</b>	Large Mounting Bracket.....	<b>39.99B</b>
<b>UTSM150MK</b>	Metal Socket Mounting Bracket - 1 1/2".....	<b>39.99B</b>
<b>UTSM138MK</b>	Metal Socket Mounting Bracket - 1 3/8".....	<b>39.99B</b>
<b>ULTB48B</b>	Lighting Crossbar.....	<b>79.99B</b>
<b>ULTV24B</b>	Lighting Vertical Extension.....	<b>49.99B</b>
<b>UBAG90</b>	Tote Bag - Holds one 90, 80 or 70 Stand.....	<b>45.99B</b>
<b>UBAG90D</b>	Tote Bag - Holds two 90, 80 or 70 Stands.....	<b>59.99B</b>
<b>UBAG99</b>	Tote Bag - Holds one 99 or 88 Stand.....	<b>49.99B</b>
<b>UBAG99D</b>	Tote Bag - Holds two 99 or 88 Stands.....	<b>69.99B</b>



ULIVESB



ULIVET

## MIC STANDS & BOOMS

<b>ULIVET</b>	One-hand Clutch, Tripod Base Mic Stand, Black.....	<b>\$109.99</b>
<b>ULIVESB</b>	One-hand, Die-Cast Clutch, Stackable Mic Stand, Black.....	<b>109.99</b>
<b>ULIVEST</b>	One-hand, Round Base, Mic Stand.....	<b>99.99</b>
<b>UPROSB</b>	Stackable Mic Stand, Black.....	<b>89.99B</b>
<b>UMC40B</b>	Mic Stand w/Boom Package, Black.....	<b>59.99B</b>
<b>PROTSHORTT</b>	Low-Level Mic Stand and Boom Package, Black.....	<b>109.99B</b>
<b>UTOURTALL</b>	Mic Stand & Boom Package, Black.....	<b>149.99B</b>
<b>UMC05B</b>	Round Base, Black.....	<b>44.99B</b>
<b>ULTIBOOMFB</b>	Mic Boom, Black.....	<b>49.99B</b>
<b>ULTIBOOMTB</b>	Black Boom.....	<b>62.99</b>
<b>UMC125</b>	Pro Studio Boom.....	<b>249.99B</b>

## PARTS

<b>UECP150</b>	Foot Cap, Speaker Stands (TS-80/88/90/99).....	<b>\$6.99B</b>
<b>UEPL151</b>	Endplug for Thick 1 1/2" Tubing.....	<b>2.99B</b>
<b>UZKB137</b>	Z-knob.....	<b>10.65B</b>
<b>UZKB175</b>	Z-knob.....	<b>10.65B</b>
<b>UTCRI50</b>	Telescoping Collar.....	<b>9.99*</b>
<b>UTFG150</b>	T-Fitting.....	<b>12.00B</b>

\* = CALL FOR DEALER NET

# HOHNER HARMONICAS

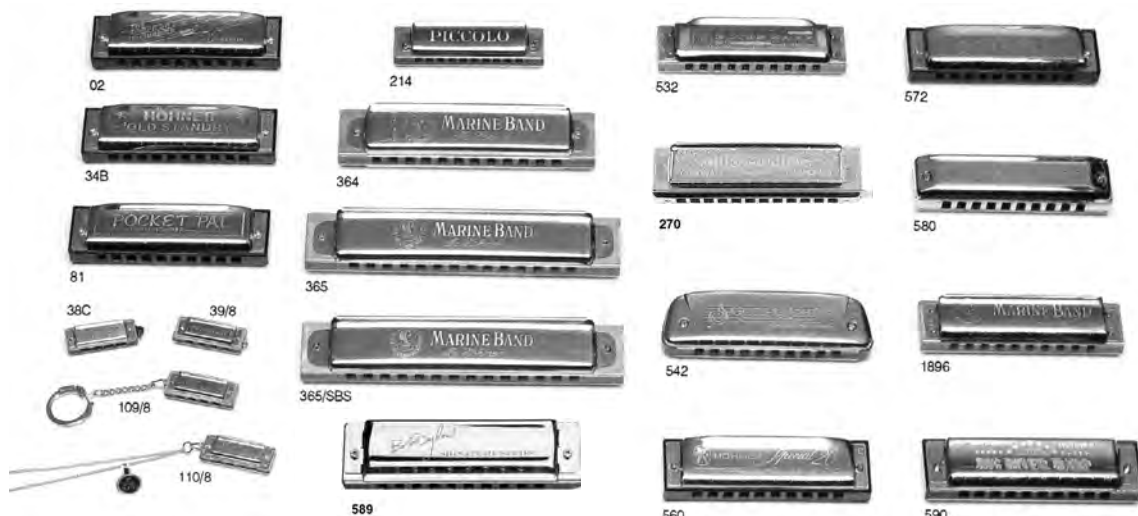

## Diatonic Harmonicas

Number	Name	Keys	Price
1510CHH	Fuego Azul	C	\$8.50B
HH02	American Ace	C, G	13.00B
HH595	Blue Midnight	(1)	42.00B
HH550	Puck	C, G	15.00B
HH553CG	Double Puck	C-G	58.00B
HH214	Piccolo	C	59.00B
HH34B	The Old Standby	(1)	16.00B
HHHK34B	Old Standby CD/Book	C	17.99B
HH38	Little Lady (China)	C	4.50B
108	Mini Harp Key Chain	C	5.50B
HH38N	Mini Harp Necklace	C	10.00B
HH39	Little Lady	C	23.00B
HH81	Pocket Pal	C	13.00B
HH109/8	Little Lady keychain	C	20.00B
HH110/8	Gold Little Lady (w/chain)	C	58.00B
HHM2005	Marine Band Deluxe	(3)	99.00B
HHM2005L	Marine Band Deluxe Low	C, F, F#	99.00B
HHM2009	Cross Over	(2)	110.00B
HHM2009L	Crossover Low	C, C#, F#	145.00B
HHM2009H	Crossover High	G	145.00B
HHM2013	Rocket	3	99.00B
HH364	Marine Band	C, G, D	81.00B
HH364S	Marine Band (Solo Tuned)	C	76.00B
HH365	Marine Band	C, G	96.00B
HH365SBS	Steve Baker Special	A, C, D, F, G	130.00B
HHST2A	Steve Tyler Artist	A	40.00B
HH588	Steve Tyler	A	133.00B
HH1501	Blues Band	C	8.50B
HH532	Blues Harp	(3)	63.00B
HH542	Golden Melody	(3)	65.00B
HH560	Special 20	(3)	62.00B
HH560CT	Special 20 (Country Tuned)	(2)	65.00B
HH572	Hot Metal	(1)	15.00B
HH580	Meisterklasse	(3)	172.00B
HHBBBL	Blues Bender	(1)	26.99B
HH590	Big River Harp	(3)	42.00B
HH592JLS	John Lennon	C	99.00B
HH595	Blue Midnight	A, Bb, C, D, E, F, G	41.00B
HH1896	Marine Band	(3)	61.00B
HH1896NM	Marine Band	A, B, C, D, E, G	65.00B
HH1896HG	Marine Band High	G	61.00B
HHM2011L	Marine Band Thunderbird	(2)	195.00B

(1) A, Bb, C, D, E, F, G  
 (2) A, B, Bb, C, D, E, Eb, F, G  
 (3) A, B, Bb, C, Db, (C#), D, E, Eb, F, F#, G, Ab, (G#)

## Tremolo Tuned Harmonicas

HH54	Echo	A-D, Bb-F, C-G	\$165.00B
HH55	Echo	A-D, C-G	200.00B
HH56	Echo	A-D, Bb-F, C-G	240.00B
HH57	Echo	C-G	310.00B
HH59	Highlander	A-D	212.00B
HH455	Echo Celeste	(3)	31.00B
HH2409	Echo	C, G	100.00B
HH2416	Golden Melody	C, G	150.00B
HH2509	Echo	C	150.00B
HH8362	Echo	C, G	30.00B
HH98-114	Weekender	C	16.00B
HH98-115	Weekender	C	25.00B

## Octave Tuned Harmonicas

HH1493	Echo	C, G	\$110.00B
HH1495	Echo	C	129.00B
HH1496	Echo	C	155.00B
HH2503	Comet	C	140.00B
HH2504	Comet	C, G	150.00B

## Blister Pack Harmonicas

81 BLPC	Pocket Pal	C	\$13.00B
1510 BLC	Fuego Azul	C	7.00B

## Chromatic Harmonicas

HHM1040	Honica Educator 10	C	\$73.00B
HH250	Chrometta 8	C	140.00B
HH253	Chrometta 10	C	180.00B
HH255	Chrometta 12	C, G	200.00B
HH257	Chrometta 14	C	225.00B
HH270	Super Chromonica	A, B, Bb, C, D, E, F, G, EF	275.00B
HH7540	Super Chromonica Deluxe	C	350.00B
HH270TC	Tenor Super Chromonica	C	275.00B
HH280	The 64 Chromonica	C	400.00B
HH7582/64	Super 64 Chromonica	C	450.00B
HH7538	Toots Mellowtone	C	440.00B
HH7539	Toots Hard Bopper	C	440.00B
HH7542	Discovery 48	C	211.00B
HH7545	CX12 Chromatic	C	330.00B
HH7545CGO	CX12 Chromatic Gold	C	490.00B
HH7545JC	CX12 Jazz C	C	600.00B
HH7584	Super 64X	C	730.00B
HH7574	Larry Adler	C	430.00B

## Accompaniment/Orchestral

HH263	Chromatica	Blow & Draw	\$760.00B
HH265	Double Bass		1723.00B
HH267	The 48 Chord		3300.00B
HH268	Double Bass-Extended	All Blow	2189.00B

## Pre Packs

HHCOB	5 Blues (532 Blues Harps) (1 ea. A, C, D, E, G w/case)	\$265.00B
HHMBC	5 Marine Bands (1896) (1 ea. A, C, D, E, G w/case)	265.00B
HHSPC	5 Special Twentys (560) (1 ea. A, C, D, E, G w/case)	265.00B
HHCOM	5 Metal (572 Hot Metal) (1 ea. A, C, D, E, G w/case)	63.00B
HH3P532	3 Pro Pack (Blues Harps) (1 ea. G, A, C)	160.00B
HH3P560	3 Pro Pack (Special 20) (1 ea. G, A, C)	158.00B
HH3P590	3 Pro Pack (Big River) (1 ea. G, A, C)	110.00B
HH3P1896	3 Pro Pack (Marine Band) (1 ea. G, A, C)	158.00B
1501/7C	7 Blues Band (A-G)	54.00B
HHHBP	Hoo Doo Blues (C, D, G)	19.00B

## IMPORTANT NOTICE

Health and Sanitary regulations prohibit the exchange or return for credit of any mouth blown instrument. If the Instrument you purchased is found to contain any defects in materials or workmanship, it must be returned, by the purchaser, to the manufacturer for adjustment.



## ASSORTMENTS



- CCH48** .....\$160.00B  
48 Clearly Colorful Harmonicas
- Piedmont Blues Harps**  
1 ea: A, Bb, C, D, E, F, G  
**HHPBH7** .....\$39.00B
- HHTMK48** .....\$170.00B  
48 Mini Harp Keychains

## AUDIX



- HARMONICA MICROPHONE.**
- FIREBALL** .....\$245.90
- FBALLV** With Volume Control .....\$212.40

## HOHNER



- HOHNER HOODOO HAND WIRELESS MIC AND AMP**
- HH1L** UHF Wireless System .....\$327.00B
- HHB5T** Class A Tube Amp .....\$440.00

## PEAVEY MICROPHONES



00563080



00597360

### H-5™ AND H-5C™ MICROPHONES

Expressive, responsive omni-directional dynamic harmonic microphone. Contoured black housing with finger placement grooves and brushed aluminum grille. Center-detent volume control. Includes detachable mini-XLR w/ 1/4" mic cable. On/off switch. Carrying case included.

- 00563080** H-5C™ Cherry Bomb™  
Red w/Black Grill .....\$179.99
- 00597360** H-5™ Harmonica Mic,  
Black w/Aluminum Grill .....\$179.99

## HOHNER HARMONICA PRE PACKS

### PRE PACKS

- HHC0B** 5 Blues (532 Blues Harps) (1 ea. A, C, D, E, G w/case) .....\$265.00B
- HHMBC** 5 Marine Bands (1896) (1 ea. A, C, D, E, G w/case) .....\$265.00B
- HHSPC** 5 Special Twentys (560) (1 ea. A, C, D, E, G w/case) .....\$265.00B
- HHCOM** 5 Metal (572 Hot Metal) (1 ea. A, C, D, E, G w/case) .....\$63.00B
- HH3P532** 3 Pro Pack (Blues Harps) (1 ea. G, A, C) .....\$160.00B
- HH3P560** 3 Pro Pack (Special 20) (1 ea. G, A, C) .....\$158.00B
- HH3P590** 3 Pro Pack (Big River) (1 ea. G, A, C) .....\$110.00B
- HH3P1896** 3 Pro Pack (Marine Band) (1 ea. G, A, C) .....\$158.00B
- 1501/7C** 7 Blues Band (A-G) .....\$54.00B
- HHHBP** Hoo Doo Blues (C, D, G) .....\$19.00B

## ACCESSORIES



### HARMONICA CASE

- HH30** Leather .....\$10.00B

### HARMONICA HOLDERS

- HH154** Hohner .....\$28.00B
- HARP** Harp Handle .....\$22.00
- HH10** KDS .....\$12.99
- IOHH** Lee Oskar .....\$27.45B
- HH01** Fits 10 Hole Models .....\$15.99B

Adjustable spring clamp that will easily fit any standard 10 hole diatonic harp

- HHM2010** Flexrack .....\$89.00B

### HOHNER HARMONICA SERVICE SET

You can: Offset the reeds to suit your playing style • Fine tune or retune your harmonica • Maintain, replace and experiment with windsavers • Adjust and lubricate the slide mechanism on chromatics.

Besides high-quality tools, it includes a set of windsavers for chromatic harmonicas and XB-40s, a tube of special "Hohner Windsaver Glue," a small bottle of slide lubricant and a detailed set of instructions. Comes in a practical nylon case.

### HARMONICA BELT

- HHB6** Holds 6 harmonicas .....\$35.00B
- HH7PHC** Gig Pouch, holds 7 .....\$40.00B

### HARMONICA CASE

ABS Plastic case with aluminum valance. Holds 12-10 hole diatonics & 1 chromatic, up to 16 hole.

- HHC12** .....\$61.99B
- HHHPN5** 5 Neoprene Pouches .....\$25.00B

### HARMONICA SERVICE SET

- HH330SS** .....\$115.00B

## HARPARM



The HarpArm™ is a magnetic harmonica holder that can be attached to all standard microphone stands and boom stands. Its innovative magnetic attachment system allows it to work with all standard harmonicas. The HarpArm™ telescopes to 16 inches.

- HA16** HarpArm™ w/HarpStrip™ .....\$29.95 ea.
- HA23** HarpArm™ 3-Pack of Strips .....\$8.95 pk.
- HA21** HarpArm™ (Individual) – Strip .....\$4.95 ea.

## DISPLAY OPTIONS/P.O.P.

- HHBHDR** Small wall display that will hold 24-30 of the new box display items .....\$900.00
- HHBHDW** Newly designed wall display unit for 90-100 of your top selling Hohner items .....\$2,900.00
- HHBHDF** Two sided floor unit display, built for 180-200 of your top selling Hohner items .....\$5,800.00
- HHMDPOP** New offering to spotlight the rapidly expanding melodica category .....Any 6

## INSTRUCTIONAL

- HHHK34B** **Old Standby Harp**  
Instructional CD, booklet and harp in key of "C" .....\$17.99B
- GLH300** **Complete Hohner Harmonica Instruction Package**  
Includes: Harmonica, 10 Hole Diatonic, Instruction/Music Book, and CD .....\$27.00B
- JWVI** Harmonica Basics, Video and Harp, J/Woods .....\$19.95B
- HOHNER106** Play and Learn, with Harmonica .....\$12.00B

## HUANG HARMONICAS



**DIATONIC, Single Reed**  
**INS102** Star Performer .....\$18.50  
**INS103** Silvertone Deluxe .....18.50  
 (C, C#, D, Eb, E, F, F#, G, Ab, A, Bb, B)  
 (Also available in Low Octave F & F#)



**CHROMATIC, Solo Tuned**  
**INS112C** Professional 124B .....\$156.25  
**INS115C** Cadet Soloist .....18.50B

One of each key, total 12 keys packaged in a deluxe carrying case.

**INS102X** Star Performer 12-Key Pack.....\$214.40B  
**INS103X** Silvertone Deluxe 12-Key Pack ..\$214.40B

## CHICAGO BLUES HARMONICA



**KHCB** C or G Key .....\$ 8.80  
**KHCB32C** Pop Display, 32 Harps, Key of C.....282.35  
**KHCB32G** Pop Display, 32 Harps, Key of G.....282.35  
**KHCB7A** 1 ea. A, B, C, D, E, F, G.....84.70B

## BLUES KING HARMONICAS



**BK520SET** 12 Harps, 12 keys, with Case (Blues King).....\$93.00

## US BLUES HARMONICAS



Diatonic 10 hold key of C  
**USBH20** .....\$7.55

## SANTA MARSALA



**3807** .....\$504.95B  
 31 treble buttons, in 3 rows 12 bass buttons, in two rows. Key Combination of GCF

## CONCERTINAS



Model		Buttons	Reeds	Folds	Key	List
<b>HHD40</b>	Hohner w/bag	20	40	9	GC	\$305.00B
<b>FI120</b>	Musiclink	20	40	9	GC	416.40
<b>SC4906</b>	Concertina bag.....					\$20.95

## LEE OSKAR HARMONICAS



### HARMONICAS

**1710** Major Tuning .....\$55.95  
**1710HM** Harmonic Minor Tuning .....55.95  
 (A, Ab, B, Bb, C, D, Db, E, Eb, F, F#, G)  
 (1710 available in low F and high G also)  
**1710NM** Natural Minor Tuning(A, C, D, E, G) .....55.95  
**1710MM** Melody Maker(A, C, D, E, G).....55.95

### REED PLATES

**1710RP** Major .....\$27.95B  
**1710NRP** Natural Minor .....27.95B  
**1710HRP** Harmonic Minor (A,C,D,E,F,G) .....27.95B

### ACCESSORIES

**10CP** Cover Plate.....\$6.90B  
**10B** Box .....6.90B  
**10HH** Harmonica Holder .....27.95B  
**LOTK** Maintenance Kit.....46.45B  
**LOHP** Harmonica Pouch .....23.20B

## ACCORDION ACCESSORIES

### INSTRUCTION BOOK

"The Art Of Playing Hohner Diatonic Accordions" .....\$6.50B

### HARDSHELL CASES

**HH10X** Fits 1622, 2815, 3000 .....95.00B  
**HH12X** Fits 1600, 3100, 3522.....105.00B

### GIG BAGS

**AGB48** 48 Bass Gig Bag.....138.00B  
**AGB72** 72 Bass Gig Bag.....180.00B  
**AGB120** 120 Bass Gig Bag.....205.00B  
**HHCGB** Corona Gig Bag.....80.00B

## HOHNER PIANO ACCORDIONS



**HA1302** 12 Bass .....\$440.00B  
**HA1304** 48 Bass.....799.00B  
**HA1305** 72 Bass.....955.00B  
 (Made in China for Hohner)  
 (With Case)

## HOHNER DIATONIC ACCORDIONS



**HA3002** Natural.....\$645.00B  
**HA3002BK** Black.....545.00B  
 Cajun tuning with reduced tremolo and lightly tempered thirds, 10 treble buttons, 2 bass buttons, 4 sets of treble reeds, 3 sets of bass reeds. Key: C. Size: 11 1/8" x 11" x 6". Weight: 5 lbs. 10 ozs. **Includes case and shoulder strap.**



**HA3100GB** Panther.....\$735.00B  
 31 Treble buttons in 3 rows. 12 bass buttons and 2 sets of treble and bass reeds. Available in key of GCF. Black matte finish.

## ACCORDION STRAPS



**AHBK** Neotech, Black Accordion Harness .....\$60.95  
**DAHJRBK** Deluxe Accordion Harness Jr. ....57.50  
**DAHBK** Neotech, Deluxe Black Accordion Harness .....65.95  
**MAHBK** Neotech, Mega Accordion Harness .....69.95  
**2300A** Padded, Leather, Small Accordion .....46.50  
**2310A** Deluxe, Leather, 1 1/2" Wide .....70.85  
**M18BLK** Levy Black, 1" leather accordion straps.....30.15

# HOHNER PLAYFUL HARMONIES RHYTHM AND WIND INSTRUMENTS

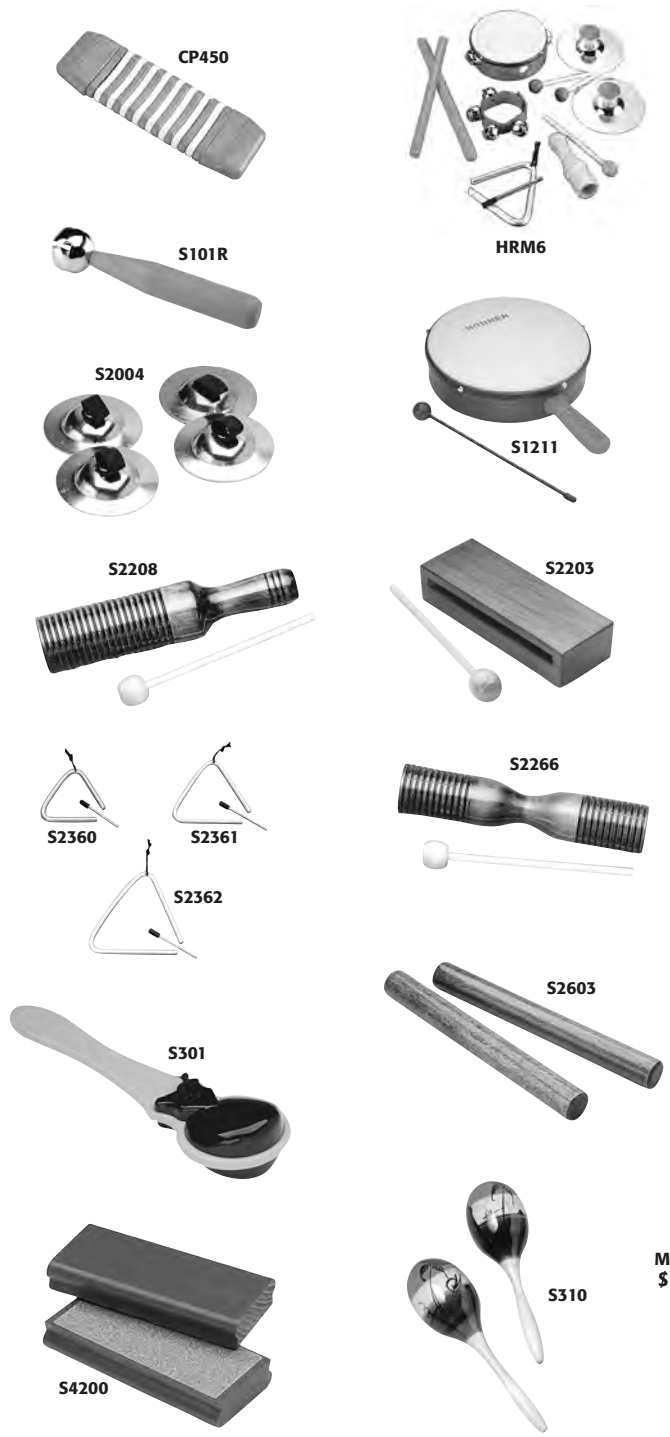

CP450	Clatterpillar .....	\$12.00
HRM6	6-Piece Set .....	45.00
PH81	Harmonica Starter Package .....	12.00
S101R	Single Bell Jingle .....	4.00
S1211	7" Hand Tom Tom .....	16.00
S2004	Finger Cymbals (set of 4) .....	12.00
S2203	Hardwood Block .....	8.00
S2207	Soprano Sounder .....	4.00
S2208	Crow Sounder .....	10.00
S2266	Two-tone Wood Block .....	9.00
S2360	4" Triangle .....	8.00
S2361	5" Triangle .....	8.00
S2362	6" Triangle .....	8.00
S2603	Hardwood Claves .....	6.00
S301	Handle Castanet .....	9.00
S310	Tri-color Wood Maracas .....	18.00
S363	Plastic Mini Maracas .....	10.00
S3800	5" Cymbals w/ Mallets .....	16.00
S4005	Three Bell Jingle .....	8.00
S4009	Wrist Bells .....	8.00
S4011	Ankle Bells .....	8.00
S4033	Handle Sleigh Bell .....	10.00
S460	Box Shakers .....	6.55
S502	Beginner Harmonica .....	11.00
S5603	Rhythm Sticks .....	5.00
S601	6" Tambourine .....	13.00
S9319	Soprano Recorder (3-piece) .....	7.00
S9636	Flutophone .....	5.00
SGC 2	8-Note Glockenspiel .....	25.00
SRM08	8" Rainmaker .....	13.00
S4200	Sand Blocks (No Handles) .....	5.00

## RHYTHM MAKERS



### PRIMARY KITS

PS12 .....	\$65.00	PS24 .....	\$116.00
(1) RB-I Instructor's Book		(1) RB-I Instructor's Book	
(1) V 4004 Tambourine Stick		(2) V 4004 Tambourine Stick	
(1) V 2603 1 pr. Claves		(2) V 26031 pr. Claves	
(2) V 4200 1 pr. Sand Blocks		(4) V 42001 pr. Sand Blocks	
(1) V 4009 Wrist Bells		(2) V 4009 Wrist Bells	
(2) V 5603 1 pr. Rhythm Sticks		(4) V 56031 pr. Rhythm Sticks	
(1) V 2207 Soprano Sounder		(3) V 2207 Soprano Sounder	
(1) V 2360 4" Triangle w/striker		(2) V 2360 4" Triangle w/striker	
(1) V 2362 8" Triangle w/striker		(1) V 2362 6" Triangle w/striker	
(1) V 2208 Large Crow Sounder		(1) V 2208 Large Crow Sounder	
		(2) V 4011 Leg Bells	

### MULTI TIMBRE KITS

MTS12 .....	\$66.95	MTS24 .....	\$133.95
(1) RB-I Instructor's Book		(1) RB-I Instructor's Book	
(1) V 2266 Two Tone Sounder		(2) V 2266 Two Tone Sounder	
(1) V 4004C Tambourine Stick		(1) V 4004C Tambourine Stick	
(1) V 2603 Claves		(2) V 2603 Claves	
(1) V 2208 Large Crow Sounder		(2) V 2208 Crow Sounder	
(1) V 4200 Sand Blocks		(3) V 4200 Sand Blocks	
(1) V 4011 Leg Bells		(2) V 4011 Leg Bells	
(1) V 5603 Rhythm Sticks		(4) V 5603 Rhythm Sticks	
(1) V 2207 Soprano Sounder		(1) V 2360 4" Triangle w/striker	
(1) V 2360 4" Triangle w/striker		(1) V 2362 8" Triangle w/striker	
(1) V 2362 6" Triangle w/striker		(1) V 3800 5" Cymbals	
(1) V 4033 Hand Bells		(3) V 4009 Wrist Bells	
		(1) V 4033 Hand Bells	

# Hohner Melodicas



## Hohner 32B Instructor Melodica

The 32B Instructor Melodica with its smooth, responsive 32-key piano keyboard is one of the most widespread and easiest ways to articulate melodies and harmonies. Rhythm and dynamics are directly controlled by your breath, naturally ebbing and flowing right through you. You get sounds like a harmonica on single notes or like an accordion when chorded. Piano keys cover the alto and soprano range from F3 to C6. With padded zippered case and mouthpiece.

**HM32B** .....\$58.00B

## 32 Ocean Melodica

32 key, Melodica features a blue trim and black keys. Ergonomic mouthpiece, smooth keyboard, and hardshell case.

**HM320 Blue** .....\$58.00B

## Fire Melodica

32 key, Melodica features a dynamic red trim and black keys. Ergonomic mouthpiece, smooth keyboard, and hardshell case.

**HM32F Red** .....\$95.00B

## Performer 37

37 key premium Melodica features responsive keyboard, and a full range musical scale. Ergonomic mouthpiece for easier playing at every level.

**HMS37** .....\$107.00B

## HM27 Melodica Piano 27

Its 27 piano keys start with F below middle C and extend up for over 2 chromatic octaves. Comfortable strap for left hand. Complete with instructions and deluxe carrying case.

**HM27** .....\$200.00B

# Melodica Accessories

<b>HMA76</b>	Mouthpiece (fits 32), 27, 26 .....	<b>\$15.00B</b>
<b>HMA25</b>	Mouthpiece (fits 900, 901) .....	<b>12.00B</b>
<b>HMA75</b>	Mouthpiece (fits 900 Series).....	<b>12.00B</b>
<b>HMA80</b>	Mouthpiece (fits 36 Series).....	<b>12.00B</b>
<b>HMA81</b>	Trumpet Style Mouthpiece (fits 36 Series) .....	<b>5.50B</b>

# Yamaha Pianicas



P25F and P32D are ideal for solo and ensemble performances, while the P37D is an outstanding soloist instrument.

<b>YP25F</b>	25 Note .....	<b>\$66.99B</b>
<b>YP32D</b>	32 Note .....	<b>73.99B</b>
<b>YP37D</b>	37 Note .....	<b>136.99B</b>

# Harris Melodicas



Black 32 keys w/airhole and canvas case.

**HM32CCBK Black** .....\$47.25

**HM32CCB Blue** .....47.25



Green 37 keys, w/airhole and canvas case.

**HM37CCG** .....\$52.00



Black 37 keys w/airhole and canvas case.

**HMA37CCBK Black**.....\$52.00



Red 37 keys, w/airhole and canvas case.

**HM37CCR Red**.....\$52.00

# Narragansett Translucent Recorders



## Soprano Recorders

Includes bag and cleaning rod. Available in: (C) Clear, (B) Blue, (G) Green, (R) Red, (PI) Pink, (PU) Purple

**NRCL** Plastic 3 piece .....\$4.10

**NRBG** Plastic 3 piece wood grain .....8.20

# Lauren Translucent Recorders



## Soprano Recorders

Classical design. Baroque fingering. Includes bag, cleaning rod and fingering chart. Full 2-octave range. Specify color: Blue (B), Clear (C), Green (G), Orange (O), Pink (PI), Red (R), Purple (PU) and Yellow (Y).

**LMREC** Plastic 3 piece .....\$5.55

## Hohner Recorders



**F-SOPRANINO**  
HH9564 Maple Baroque.....\$195.00B

**C SOPRANO**  
HH9520 Pearwood Baroque.....\$47.00B  
HH9522 Maple Baroque .....49.99B  
HH9532 Concert - Pearwood Baroque .....124.00B  
HH9508 Plastic 1 Pc. German .....16.50B  
HH9509 Plastic 1 Pc. Baroque .....16.50B  
HH9514 Studio - Pearwood Baroque .....82.00B  
HH9544 Luxury - Maple Baroque .....168.99B

**F-ALTO**  
HH9574 Concert Pearwood Baroque .....\$390.00B  
HH9577 Plastic Baroque .....128.00B

**C-TENOR**  
HH9614 Concert Pearwood Baroque .....\$740.00B

**F-BASS**  
HH9631 Concert Pearwood Concert.....\$1675.00B

## Aulos Recorders



NO.	FINGERING	COLOR	LIST
Piccolo C.....AA501S	Baroque	Brown.....	\$51.10B
Soprano.....AA507	Baroque	Dark Brown.....	25.90B
Soprano.....AA202A	German, 2 pc.	Ivory.....	12.20B
AA203A	Baroque, 2 pc.	Ivory.....	12.20B
AA102N	German, 1 pc.	Dark Brown.....	15.00B
AA103N	Baroque, 1 pc.	Brown.....	15.40B
AA303Al	Baroque, 3 pc.	Ivory.....	12.60B
AA703B	Baroque, 3 pc.	Brown.....	28.30B
AA703BW	Baroque, 3 pc.	Woodgrain.....	55.85B
AA503B	Baroque	Dark Brown.....	35.00B
Alto.....AA209B	Baroque	Dark Brown.....	37.80B
AA309A	Baroque	Dark Brown.....	55.30B
AA509B	Baroque	Dark Brown.....	67.20B
AA709B	Baroque, 3 pc.	Brown.....	63.70B
AA709BW	Baroque, 3 pc.	Woodgrain.....	88.90B
Tenor.....AA211AE	Baroque, 3 pc.	Dark Brown.....	98.55B
Fife.....AC21		Ivory.....	27.05B
Thumb Rest.....TA1		Fits AA209N, 309, 509.....	2.75B
Thumb Rest.....TS2		Fits AA202N, 203N.....	1.65B
Thumb Rest.....TT1		Fits AA311N.....	3.15B

## Cambridge Recorder



Made of duranite. Full chromatic scale. Key of C. Three piece construction.

575 Soprano, Dark Brown .....\$7.00  
577 Soprano, Ivory .....7.00  
675 Soprano, Brn. German Fingering.....6.95  
8495 Cleaning Rod, Plastic......55  
CG070RE Soprano Bag.....2.05

### HODGE SWABS

100% China silk available in **Black (BK)**, **Purple (PU)**, **Blue (B)**, **Burgundy (BU)**, **Green (G)**, **Pink (PI)**, **Silver (SI)**.

HSRS Soprano Recorder .....\$6.50  
HARS Auto Recorder .....10.00

## GIA Recorder



### RENAISSANCE MODEL

M447 Soprano, C 2 Piece.....\$5.35B

## GODDEN RECORDERS

Includes Bag & Cleaning Rod • New Head Design • Micro Design Tolerance • Resin Composite • Unique Curved Comfort • Adjustable Foot • Easy to Blow!

GNB400 Fingering Baroque Soprano-C, 3 Piece, Ivory.....\$5.95

Plastic 3 piece with leather, case, end caps, and cleaning rod. Black with ivory trim.

GNB500 Alto Recorder.....\$28.95

Plastic with leather case, end caps, cleaning rod. Features adjustable thumb rest, double bell key, baroque fingering. Black with ivory trim.

GNB600 Tenor Recorder.....\$113.00

## Tudor Recorders



TD180 Translucent Soprano 2 Piece.....\$6.55  
Available in: (B) Blue, (GO) Gold, (G) Green, (PU) Purple, (R) Red

TD175 Soprano - C - 1 piece.....\$4.00  
TD185 Soprano - C - 2 piece.....5.95  
TD200 Soprano - C - 2 piece w/T Rest.....10.00  
TD205 Soprano - C - 2 piece.....8.95  
TD206 Soprano Renaissance.....8.95  
TD186 Soprano, German, 2 piece.....5.95  
TD195 Soprano - C - 3 piece.....8.95  
TD275 Alto - F.....35.05  
TD375 Tenor - C - Single Key on bell.....109.50  
TD775 Bass - F - double key on bell, & two single keys on body.....475.00

### TROPHY RECORDER DISPLAY

2 each of 6 colors  
15512.....\$23.90

## SONGFLUTE



The standard instrument for kindergarten and grade classroom. Inspires the young to musical accomplishment.

CG981 Songflute.....\$4.15

## Angel Recorders



Angel Recorders feature ABS resin construction, and include bag, cleaning rod, and fingering chart. Recorders are brown with white mouthpieces and trim.

### SOPRANINO

A301N Baroque, 3 piece.....\$11.75

### SOPRANO

A101 Baroque, 1 piece.....4.20  
A111 Baroque, 2 piece.....5.85  
A211 Baroque, 3 piece.....8.05  
A301 Baroque, 3 piece.....11.10  
A321 Baroque, 3 piece, w/Thumb Rest.....9.25

### ALTO

A101A Baroque, 3 piece.....33.55  
A201A Baroque, 3 piece, Wood Grain.....54.25

### TENOR

A401T Baroque, 3 piece, dlx. trim.....116.60

## FLUTOPHONE



A musical instrument for classroom or home. Accurate scale.

9002W White.....\$4.30  
9002BK Black.....4.30  
303D Clear Plastic Bag.....1.95

# YAMAHA PLASTIC RECORDERS



## 20 SERIES

Yamaha 20 series recorders are constructed from ABS resin for durability. Each instrument is packaged in a bag with a fingering chart and owner's manual.

<b>YAC1015P</b>	Cream for Recorders.....	<b>\$4.99</b>
<b>YRN22B</b>	Sopranino; key of F; Baroque fingering, 3-Piece.....	<b>9.99</b>
<b>YRS24B</b>	Soprano; key of C; Baroque fingering, 3-Piece.....	<b>9.99</b>
<b>YRS23</b>	Soprano; key of C; German fingering, 3-Piece.....	<b>9.99</b>
<b>YRA28B</b>	Alto; key of F; Baroque fingering, 3-Piece.....	<b>29.99</b>
<b>YRF21</b>	Fife; key of C; German fingering, 3-Piece.....	<b>9.99</b>

## TRANSLUCENT 3 PIECE

<b>YRS20BB</b>	Cotton Candy Blue, Soprano.....	<b>\$9.99</b>
<b>YRS20BG</b>	Sour Apple Green, Soprano.....	<b>9.99</b>
<b>YRS20BP</b>	Bubble Gum Pink, Soprano.....	<b>9.99</b>

SPECIAL QUANTITY PRICING AVAILABLE

## GENERATION FLAGEOLET



The original British made Flageolet (Tin-Whistle). Display card of 12 Flageolets.

<b>F5380</b>	.....	<b>\$171.30</b>
<b>NICKEL</b>		
<b>F5371</b>	Bb.....	<b>\$18.45</b>
<b>F5372</b>	C.....	<b>15.35</b>
<b>F5373</b>	D.....	<b>14.10</b>
<b>F5374</b>	Eb.....	<b>13.75</b>
<b>F5375</b>	F.....	<b>13.50</b>
<b>F5376</b>	G.....	<b>12.85</b>
<b>BRASS</b>		
<b>F5381</b>	Bb.....	<b>\$14.45</b>
<b>F5382</b>	C.....	<b>13.50</b>
<b>F5383</b>	D.....	<b>12.10</b>
<b>F5384</b>	Eb.....	<b>11.75</b>
<b>F5385</b>	F.....	<b>11.30</b>
<b>F5386</b>	G.....	<b>10.95</b>

<b>F6600</b>	Card of 12 D, All Brass.....	<b>\$142.85</b>
<b>F6601</b>	D, Brass.....	<b>12.10</b>

## WALTONS TIN WHISTLES

Walton's tin whistles are the best-selling whistles in Ireland. Available in the keys of D and C.

### IRISH BRASS WHISTLE

<b>IBC</b>	(Key of "C").....	<b>9.95D</b>
<b>IBD</b>	(Key of "D").....	<b>8.95D</b>

### LITTLE BLACK WHISTLE WD

<b>LBWD</b>	(Key of "D") Light Aluminum.....	<b>6.95D</b>
-------------	----------------------------------	--------------

### MELLOW D IRISH WHISTLE

<b>MIWD</b>	(Key of "D") Brass/Wide Barrel.....	<b>8.95D</b>
-------------	-------------------------------------	--------------

## FEADOG TIN WHISTLE

<b>IW10</b>	Key of "D".....	<b>\$11.10</b>
<b>IW10BK</b>	Black, Key of "D".....	<b>13.85</b>
<b>FW07</b>	Key of "D", Bulk.....	<b>9.55</b>
<b>FW17A</b>	Pro Whistle Nickel D, Heavier Barrell.....	<b>23.85</b>
<b>FW20A</b>	Key of "C" Brass.....	<b>13.90</b>
<b>FW21A</b>	Key of "C" Nickel.....	<b>18.80</b>
<b>FW26A</b>	Pro Whistle Black D, Heavier Barrell.....	<b>20.65</b>
<b>FW26</b>	Key of "D".....	<b>13.85</b>

(B) Blue, (G) Green, (R) Red, (PI) Pink

Tin Whistle, instruction book, and CD.

<b>IW30</b>	.....	<b>32.80</b>
-------------	-------	--------------

## AMPLATE FIFE

<b>150CN</b>	Nickel Fife in C.....	<b>\$20.25</b>
--------------	-----------------------	----------------

## ACORN WHISTLE



Key of D. (BK) Black, (BR) Brass

<b>AP</b>	.....	<b>\$9.99B</b>
-----------	-------	----------------

## 300 SERIES

The Rottenburg style recorders utilize ABS resin for strength and feature an arched wind way and hollow construction of the fipple block. All 300 series recorders are packaged in a bag with a fingering chart, owner's manual, cleaning rod, and cream.

<b>YAC1015P</b>	Cream for Recorders.....	<b>\$4.99</b>
<b>YRN302B</b>	Sopranino; key of F; Baroque fingering;.....	<b>23.99</b>
	double holes: F-F#, G-G#; two piece construction.	
<b>YRS302B</b>	Soprano; key of C; Baroque fingering;.....	<b>27.99</b>
	double holes: C-C#, D-D#; three piece construction.	
<b>YRS301</b>	Soprano; key of C; German fingering;.....	<b>25.99</b>
	double holes: C-C#, D-D#; three piece construction.	
<b>YRA302B</b>	Alto; key of F; Baroque fingering;.....	<b>48.99</b>
	double holes: F-F#, G-G#; three piece construction.	
<b>YRT304B</b>	Tenor; key of C; Baroque fingering;.....	<b>108.99</b>
	double holes: D-D#, double C-C key; thumb rest; three piece construction.	
<b>YRB302B</b>	Bass; key of F; Baroque fingering;.....	<b>444.99</b>
	double holes: G-G#, double keys: F-F#; single keys: Bb, C; four piece construction with curved neck, free blowing system, strap included.	
<b>YRS312B</b>	Soprano; key of C; Baroque fingering;.....	<b>40.99</b>
	three piece construction; simulated rosewood finish; double holes: C-C#, D-D#.	
<b>YRS314B</b>	Soprano; key of C; Baroque fingering;.....	<b>40.99</b>
	three piece construction; simulated brown wood grain finish; double holes: C-C#, D-D#.	
<b>YRA312B</b>	Alto; key of F; Baroque fingering;.....	<b>57.99</b>
	three piece construction; simulated rosewood finish; double holes: F-F#, G-G#.	
<b>YRA314B</b>	Alto; key of F; Baroque fingering;.....	<b>57.99</b>
	three piece construction; simulated brown wood grain finish; double holes: F-F#, G-G#.	

## CLARKE TIN WHISTLE



<b>CTWOBC</b>	Black in C No Diamonds.....	<b>\$25.50</b>
<b>CTWOBD</b>	Black in D No Diamonds.....	<b>25.50</b>
<b>CTWOGC</b>	Green in C No Diamonds.....	<b>25.50</b>
<b>CTWOGD</b>	Green in D No Diamonds.....	<b>25.50</b>
<b>CTWPOUCHC</b>	Pouch for C Whistle.....	<b>6.55</b>
<b>CTWPOUCHD</b>	Pouch for D Whistle.....	<b>6.55</b>
<b>944341X</b>	(key of "C").....	<b>25.20</b>
<b>944351X</b>	(key of "D").....	<b>25.20</b>
<b>CON</b>	Natural C (Silver Painted).....	<b>25.50</b>
<b>DON</b>	Natural D (Silver Painted).....	<b>25.50</b>
<b>MEG</b>	D (Silver Painted).....	<b>9.55</b>
<b>CWD</b>	Celtic D, Boxed.....	<b>14.10</b>

Gift Set. Whistle, Book and CD.

<b>C200GD</b>	Key of D.....	<b>\$63.80</b>
<b>TUTOR</b>	Book.....	<b>28.65</b>

## INTERNATIONAL PENNYWHISTLES

### AMERICAN PENNY WHISTLE

<b>APD</b>	(Key of "D") Brass.....	<b>\$11.95D</b>
------------	-------------------------	-----------------

### ENGLISH PENNY WHISTLE

<b>EPD</b>	(Key of "D") Brass.....	<b>11.95D</b>
------------	-------------------------	---------------

### SCOTTISH PENNY WHISTLE

<b>SPD</b>	(Key of "D") Brass.....	<b>11.95D</b>
------------	-------------------------	---------------

## SWEETONE TIN WHISTLE



<b>STC</b>	Key of "C".....	<b>\$12.20</b>
<b>STD</b>	Key of "D".....	<b>12.80</b>

Available in (BK) Black, (R) Red, (B) Blue, (G) Green, (SI) Silver

<b>CSTN</b>	Natural C.....	<b>\$10.15</b>
-------------	----------------	----------------

## OAK PENNY WHISTLE



<b>OPC</b>	C.....	<b>\$12.95B</b>
<b>OPD</b>	D.....	<b>10.95B</b>

## KAZOOS



Popular always! Red and blue enamel finish.

<b>D19</b>	2 dozen .....	<b>\$122.40</b>
<b>701B</b>	Metal Kazoo, Carded .....	<b>4.30</b>
<b>701</b>	Metal Kazoo .....	<b>3.60</b>
<b>FN125</b>	Metal Kazoo, Carded .....	<b>4.30</b>
<b>201K</b>	Trombone .....	<b>22.85</b>
<b>202K</b>	Trumpet .....	<b>22.85</b>
<b>206K</b>	French Horn .....	<b>22.85</b>

### HOHNER KAZOOS

<b>KC50</b>	50 Asst. colors .....	<b>\$45.00B</b>
-------------	-----------------------	-----------------



### SCOTTY KAZOOS

<b>7700</b>	50 Asst. colors .....	<b>\$60.35</b>
-------------	-----------------------	----------------

## KAZOOBIE



WAZ1

EHK1

<b>WAZ1</b>	.....	<b>\$4.15</b>
<b>EHK1</b>	Electric Kazoo .....	<b>24.25</b>
<b>LK1</b>	Lanyard Kazoo .....	<b>2.05</b>
<b>KAZG1</b>	Kazoogie .....	<b>2.10</b>
<b>WAZG1</b>	Wazoogie .....	<b>5.50</b>
<b>KZB1</b>	Kazobo .....	<b>13.40</b>
<b>CTCK</b>	50, Individually Bagged .....	<b>60.65</b>

## FISH BOWL DISPLAYS



<b>10072</b>	Hum A Zoos (72) .....	<b>\$107.30</b>
--------------	-----------------------	-----------------



<b>12050</b>	Plastic Kazoos (50) .....	<b>\$64.50</b>
--------------	---------------------------	----------------



<b>12550</b>	Metal Kazoos (50) .....	<b>\$184.50</b>
--------------	-------------------------	-----------------

## FISH BOWL DISPLAYS



<b>24 EA:</b>	Kazoos, Nose Flutes, Humazoos	
<b>10123</b>	.....	<b>71.30</b>



<b>11072</b>	Snoot Flute (72) .....	<b>71.30</b>
--------------	------------------------	--------------



<b>13072</b>	Lip Siren Whistles (72) .....	<b>\$56.90</b>
--------------	-------------------------------	----------------



<b>12824</b>	Wrist Bells (24) .....	<b>\$108.00</b>
--------------	------------------------	-----------------



<b>BB24C</b>	Skull Shakers (24) .....	<b>\$84.00</b>
--------------	--------------------------	----------------

## SLIDE WHISTLE



<b>12</b>	assorted colors, plastic slide whistles.	
<b>30C</b>	.....	<b>\$51.00</b>

## DIXIE FIFE

Two octave range. Raised tone holes, bright colored body.

12 pieces per display card.



<b>35</b>	.....	<b>\$45.00</b>
-----------	-------	----------------

## MUSIC MAKERS



FN100



FN152

<b>8520</b>	Humanatone (Snoot Flute) .....	<b>\$11.90 dz.</b>
<b>302</b>	American Songwhistle .....	<b>24.30</b>
<b>150CN</b>	Metal Fife .....	<b>20.25</b>
<b>TH472</b>	Hudon, Slidewhistle .....	<b>56.85</b>
<b>W10</b>	Slidewhistle .....	<b>22.95</b>
<b>FN152</b>	Ocarina .....	<b>7.50</b>
<b>EHK1</b>	Electric Kazoo .....	<b>24.25</b>

Individually carded musical novelties.

<b>FN100</b>	Hum A Zoo .....	<b>\$2.05</b>
<b>FN110</b>	Snoot Flute .....	<b>1.50</b>
<b>FN120</b>	Plastic Kazoo .....	<b>2.05</b>
<b>FN130</b>	Magic Flute .....	<b>2.95</b>
<b>FN140</b>	Dixie Flute .....	<b>3.85</b>
<b>FN150</b>	Slide Whistle .....	<b>5.35</b>
<b>FN152</b>	Sweet Potato .....	<b>7.50</b>
<b>FN160</b>	Jaw Harp .....	<b>6.00</b>

## BLUE GRASS JAW HARPS



Supplied in beautiful plating, it has tremendous eye-appeal.

<b>8037</b>	.....	<b>\$6.55</b>
-------------	-------	---------------

## SNOOPY JAW HARPS



Patterned after the original American jaw harp, sturdy, deluxe chrome-plated instrument of special tempered steel.

<b>3490</b>	.....	<b>\$7.00 ea.</b>
-------------	-------	-------------------

## OZARK JAW HARPS



Display card contains 12 lacquered-steel frame, Swedish blue-steel tongue Jaw Harps with plastic ball on end of tongue. Jaw Harp is 2-1/4" long. Each display card is packaged in a cardboard box.

<b>3485</b>	.....	<b>\$95.40</b>
-------------	-------	----------------

## JAW HARPS



Austrion Jaw Harps Available in 3 different pitches. Deluxe Chrome Plating.

<b>3492</b>	Soprano .....	<b>\$10.00</b>
<b>3493</b>	Alto .....	<b>10.95</b>
<b>3494</b>	Tenor .....	<b>13.00</b>

## MOLLARD BATONS

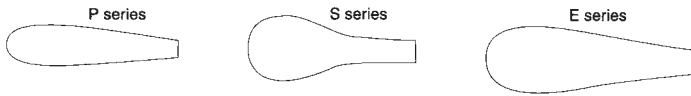

<b>P12CW</b>	12" Cocobolo.....	<b>\$31.95B</b>
<b>P14CW</b>	14" Cocobolo.....	<b>31.95B</b>
<b>P12PW</b>	12" Purpleheart.....	<b>31.95B</b>
<b>P14PW</b>	14" Purpleheart.....	<b>31.95B</b>
<b>P12WW</b>	12" Walnut .....	<b>31.95B</b>
<b>P14WW</b>	14" Walnut .....	<b>31.95B</b>
<b>P12ZW</b>	12" Zebrawood .....	<b>31.95B</b>
<b>P14ZW</b>	14" Zebrawood .....	<b>31.95B</b>
<b>P12OW</b>	12" Oak .....	<b>31.95B</b>
<b>P14OW</b>	14" Oak .....	<b>31.95B</b>
<b>E14CW</b>	14" Cocobolo.....	<b>31.95B</b>
<b>E16CW</b>	16" Cocobolo.....	<b>31.95B</b>
<b>E14ZW</b>	14" Zebrawood .....	<b>31.95B</b>
<b>E16ZW</b>	16" Zebrawood .....	<b>31.95B</b>
<b>S12OW</b>	12" Oak .....	<b>31.95B</b>
<b>S12PW</b>	12" Purpleheart.....	<b>31.95B</b>
<b>S14OW</b>	14" Oak .....	<b>31.95B</b>
<b>S14PW</b>	14" Purpleheart.....	<b>31.95B</b>

Also available in: (MW) Maple and (RW) Rose  
 P = 7 Grams E = 14 Grams S = Pearshape  
 W = White Shaft N = Natural Shaft

**DSR30** Round Display, holds 30 batons .....**\$75.00**

## MOLLARD BRITE STIX



Day Glow Colors. Coating Glows in Black Light. Lightweight and balanced. Cork Handles. Three Handle Styles: Small, Medium, Large

<b>BS12SP</b>	12" Pink, Small Handle .....	<b>\$25.95B</b>
<b>BS12SO</b>	12" Orange, Small Handle.....	<b>25.95B</b>
<b>BS12SY</b>	12" Yellow, Small Handle.....	<b>25.95B</b>
<b>BS12SG</b>	12" Green, Small Handle.....	<b>25.95B</b>
<b>BS12MP</b>	12" Pink, Medium Handle.....	<b>25.95B</b>
<b>BS12MO</b>	12" Orange, Medium Handle.....	<b>25.95B</b>
<b>BS12MY</b>	12" Yellow, Medium Handle.....	<b>25.95B</b>
<b>BS12MG</b>	12" Green, Medium Handle .....	<b>25.95B</b>
<b>BS14MP</b>	14" Pink, Medium Handle.....	<b>25.95B</b>
<b>BS14MO</b>	14" Orange, Medium Handle.....	<b>25.95B</b>
<b>BS14MY</b>	14" Yellow, Medium Handle.....	<b>25.95B</b>
<b>BS14MG</b>	14" Green, Medium Handle .....	<b>25.95B</b>
<b>BS14LP</b>	14" Pink, Large Handle.....	<b>25.95B</b>
<b>BS14LO</b>	14" Orange, Large Handle.....	<b>25.95B</b>
<b>BS14LY</b>	14" Yellow, Large Handle.....	<b>25.95B</b>
<b>BS14LG</b>	14" Green, Large Handle .....	<b>25.95B</b>

## HAMEL SPUN GLASS BATONS

They look and feel like the finest wood batons, but are guaranteed not to break! Hardwood handles.

<b>HAM98</b>	10" Petite Special .....	<b>\$7.80</b>
<b>HAM99</b>	12" Petite Special.....	<b>7.80</b>
<b>HAM100</b>	14" Petite Special.....	<b>7.80</b>
<b>HAM101</b>	16" Petite Special.....	<b>7.80</b>
<b>HAM198</b>	10" Petite Regular .....	<b>7.80</b>
<b>HAM199</b>	12" Petite Regular .....	<b>7.80</b>
<b>HAM200</b>	14" Petite Regular .....	<b>7.80</b>
<b>HAM201</b>	16" Petite Regular .....	<b>7.80</b>
<b>HAM300</b>	18" Pear Shaped .....	<b>8.25</b>
<b>HAM301</b>	20" Pear Shaped .....	<b>8.25</b>
<b>HAM302</b>	22" Pear Shaped .....	<b>8.25</b>
<b>HAM400</b>	18" Slim Taper .....	<b>8.25</b>
<b>HAM401</b>	20" Slim Taper .....	<b>8.25</b>
<b>HAM402</b>	22" Slim Taper .....	<b>8.25</b>
<b>HAM614</b>	14" Master/Large Shaft .....	<b>8.55</b>
<b>HAM616</b>	16" Master/Large Shaft .....	<b>8.55</b>
<b>HAM618</b>	18" Master/Large Shaft .....	<b>8.55</b>
<b>HAM620</b>	20" Master/Large Shaft .....	<b>8.55</b>
<b>HAM622</b>	22" Master/Large Shaft .....	<b>8.55</b>
<b>HAM1199</b>	12" Petite Special w/Cork.....	<b>9.30</b>
<b>HAM1200</b>	14" Petite Special w/Cork.....	<b>9.30</b>
<b>HAM1397</b>	12" Slim Taper w/Cork .....	<b>9.30</b>
<b>HAM1398</b>	14" Slim Taper w/Cork .....	<b>9.30</b>

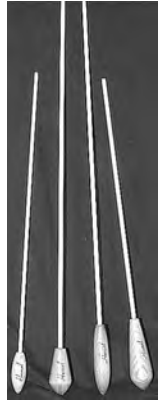

100 300 400 600

## MAESTRO LEADER BATONS



<b>TR6B •</b>	12" tapered cork handle, white Duco shaft .....	<b>\$7.80B</b>
<b>TR7B •</b>	14" tapered cork handle, white Duco shaft .....	<b>7.80B</b>
<b>TR11B •</b>	12" pear cork handle, white Duco shaft .....	<b>7.80B</b>
<b>TR12B •</b>	14" pear cork handle, white Duco shaft .....	<b>7.80B</b>
<b>TR8B •</b>	16" tapered cork handle, white Duco shaft .....	<b>7.80B</b>
<b>TR13B •</b>	16" pear cork handle, white Duco shaft .....	<b>7.80B</b>
<b>TR14B •</b>	18" pear cork handle, white Duco shaft .....	<b>7.80B</b>
<b>TR9B •</b>	18" tapered cork handle, white Duco shaft .....	<b>7.80B</b>
<b>TR10B •</b>	20" tapered cork handle, white Duco shaft .....	<b>7.80B</b>
<b>TR15B •</b>	20" pear cork handle, white Duco shaft .....	<b>7.80B</b>
<b>SS8015P</b>	14" pear rubber handle.....	<b>4.80</b>
<b>SS8015T</b>	14" tapered rubber handle.....	<b>4.80</b>
<b>TR2000</b>	12 assorted batons .....	<b>93.60B</b>
<b>TR2000W</b>	12 Assorted wood handle batons .....	<b>102.00B</b>
<b>TR7BLB</b>	Light up baton.....	<b>19.95B</b>

• = Available with wood handle. Add \$2.40 to list

## MOLLARD LANCIO BATONS



Handles of high grade anodized aircraft aluminum

<b>L12SWCF</b>	12" White Carbon Fiber Shafts, Silver Alum. Handel .....	<b>\$55.95B</b>
<b>L12BWCF</b>	12" White Carbon Fiber Shafts, Black Alum. Handle .....	<b>55.95B</b>
<b>L12GWCF</b>	12" White Carbon Fiber Shafts, Gold Alum. Handle.....	<b>55.95B</b>
<b>L14SWCF</b>	14" White Carbon Fiber Shafts, Silver Alum. Handle .....	<b>55.95B</b>
<b>L14BWCF</b>	14" White Carbon Fiber Shafts, Black Alum. Handle .....	<b>55.95B</b>
<b>L14GWCF</b>	14" White Carbon Fiber Shafts, Gold Alum. Handle.....	<b>55.95B</b>
<b>L16BWCF</b>	16" White Carbon Fiber Shafts, Black Alum. Handle .....	<b>55.95B</b>

Overall lengths (including handle): 12 inches (305mm), 14 inches (355mm)  
 Handle size: 12 inch baton: 0.75 inches x 2 inches (20mm x 50mm), 14 inch baton: 0.75 inches x 2.25 inches  
 Weight: 12 inch (.65 oz.), 14 inch (.70 oz.)

PLEASE NOTE: during the gold anodizing process, slight color variations occur and the color of each gold handle may vary slightly, even within the same order. Additionally, the color your computer monitor displays for our images gold, silver and black batons may be slightly different from the color you receive.



## KING DAVID BATONS



MODEL #	SHAFT	HANDLE	RETAIL
12CSBL	12" Clear Lacquer	Black Lacquer	5.40
12WTCK	12" Lacquer Lacquer	Taper Cork	9.50
12WPCK	12" White Lacquer	Pear Cork	9.50
14CSBL	14" Clear Lacquer	Black Lacquer	4.50
14WTCK	14" White Lacquer	Taper Cork	9.50
14WPCK	14" White Lacquer	Pear Cork	9.50
16CSBL	16" Clear Lacquer	Black Lacquer	5.40
16WTCK	16" White Lacquer	Taper Cork	9.50
16WPCK	16" White Lacquer	Pear Cork	9.50

### DISPLAY ASSORTMENT

26 assorted batons with black walnut display stand	
KDDA.....	\$465.00
KDDS Black Walnut stand Only.....	149.50

## GEMWOOD® HANDLE BATONS



Batons individually packaged in rigid clear acrylic display/carry case

MODEL	BIRCH SHAFT	HANDLE	RETAIL
12WTRS	12" White Lacquer	Taper Rosewood	\$28.20
14WTRS	14" White Lacquer	Taper Rosewood	28.20
16WTRS	16" White Lacquer	Taper Rosewood	28.20
12WSPRS	12" White Lacquer	Pear Rosewood	28.20
14WSPRS	14" White Lacquer	Pear Rosewood	28.20
16WSPRS	16" White Lacquer	Pear Rosewood	28.20

## MELODY HARP



The Melody Harp is a highly-polished, wood crafted instrument. Truly one of the world's easiest and fun musical instruments to play! Simply slide a song sheet under the strings, fold down the "tab" to hold the music in place and follow the "dots" with your pick. In minutes anyone will sound like they've taken music lessons for years.

FN600	Melody Harp .....	\$50.00B
FN6C	Soft Case .....	19.50
BWAHK	Tuning Key .....	10.95

### MUSIC PACKS

TMP05	Popular Songs.....	\$5.95
TMP10	Children Songs 1.....	5.95
TMP15	Children Songs 2.....	5.95
TMP25	Folk Songs 1 .....	5.95
TMP30	Folk Songs 2 .....	5.95
TMP35	Christmas Songs.....	5.95
TMP45	Blank Song Sheets.....	5.95

Each music pack contains 12 songs.  
MP45 lets you write your own songs.

## STAR LINE TWIRLING BATONS



SU	SUPER STAR is world's most popular twirling baton. Flued shaft.....	\$36.00
VN	VENUS with dimensional stars on the ball, and has hand-hammered look bans on shaft.....	32.00
SR	STARLET has sleek ball and tip and plain shaft.....	27.00
SUB	SUPER STAR BALL .....	7.00
SUT	SUPER STAR TIP .....	7.25
VNB	VENUS BALL .....	6.50
SRB	STARLET BALL .....	6.00
VNSRT	VENUS-STARLET TIP .....	5.25

*3/8" Diameter (Available in 16" - 30" Lengths)*

## MOLLARD BATON CASES



P69C

P69C	Cherry case, Fits P Series .....	\$91.95B
P690	Oak case, Fits P Series .....	91.95B
P69W	Walnut case, Fits P Series.....	91.95B
E69CVR	Case Cover .....	38.95B
P69CVR	Case Cover .....	38.95B

### UNIVERSAL

E69C	Cherry case .....	91.95B
E69W	Walnut case.....	91.95B
MBT	Tote bag .....	38.95B
G2008M	Maple case.....	64.95B
G2008CVR	Case cover.....	38.95B

## SYMPHONY BATONS



Symphony batons are available in exotic wood handles.

TR2000EW	(Display with 8 batons) .....	\$132.00
TR12EZ	12", Ziricote handle.....	16.50
TR14EZ	14", Ziricote handle.....	16.50
TR12EM	12", Morado handle.....	16.50
TR14EM	14", Morado handle.....	16.50
TR12EC	12", Cocobolo handle .....	16.50
TR14EC	14", Cocobolo handle .....	16.50
TR12EB	12", Bocate handle.....	16.50
TR14EB	14", Bocate handle.....	16.50
TR12ER	12", Rosewood handle .....	16.50
TR14ER	14", Rosewood handle .....	16.50

## MELODEE BELLS



Scientifically Tuned - F to F

4766.....	\$42.00B
-----------	----------

## FIRST NOTE MUSICAL INSTRUMENTS

<b>FN908</b> XYLO, 8 Note, Wooden ..... <b>\$47.40</b>	<b>FN200</b> Rhythm Sticks..... <b>3.40</b>
<b>FN915</b> XYLO, 15 Note, Wooden ..... <b>59.40</b>	<b>FN205</b> Castanets ..... <b>2.99</b>
<b>FN100</b> Hum-A-Zoo ..... <b>2.00</b>	<b>FN210</b> Finger Cymbals..... <b>8.50</b>
<b>FN110</b> Nose Flute ..... <b>1.49</b>	<b>FN215</b> Jingle Sticks ..... <b>5.30</b>
<b>FN120</b> Kazoo, plastic ..... <b>2.00</b>	<b>FN220</b> Sleigh Bells..... <b>7.00</b>
<b>FN125</b> Metal Kazoo..... <b>4.00</b>	<b>FN225</b> Sand Blocks w/Handles ..... <b>6.50</b>
<b>FN130</b> Magic Flute ..... <b>2.80</b>	<b>FN228</b> Wrist/Ankle Bells ..... <b>5.95</b>
<b>FN140</b> Fife ..... <b>3.60</b>	<b>FN230</b> Triangles ..... <b>7.69</b>
<b>FN145</b> Harmonica ..... <b>7.50</b>	<b>FN232</b> Musical Spoons ..... <b>10.00</b>
<b>FN150</b> Slide Whistle ..... <b>5.00</b>	<b>FN234</b> Tambourine ..... <b>9.50</b>
<b>FN152</b> Sweet Potato ..... <b>7.00</b>	<b>FN235</b> Castanets on Handle ..... <b>8.95</b>
<b>FN153</b> Flutophone..... <b>4.50</b>	<b>FN240</b> Cymbals ..... <b>14.00</b>
<b>FN155</b> Recorder ..... <b>5.30</b>	<b>FN242</b> Tone Block..... <b>6.00</b>
<b>FN160</b> Jaw Harp..... <b>5.99</b>	<b>FN250</b> Maracas ..... <b>9.50</b>



## WRIGHT-WAY TEACHING AIDS

### WILLIAMS RECORD BOOKS

#### WILLIAMS MUSIC TEACHER'S BOOKKEEPING BOOK

Yearly record, itemizing teaching income and expenses, includes pages for appointment schedules, memorandums, address and phone numbers, other information. Spiral bound.....**\$6.00**

#### WILLIAMS PUPIL'S RECORD BOOK

Complete yearly lesson or practice record, expanded to include blank music staves for writing exercises. Handy, 8vo size. Spiral bound.....**4.50**

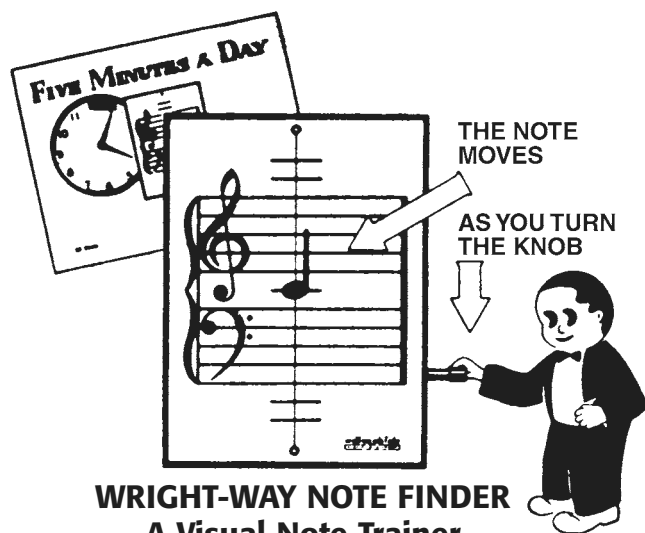
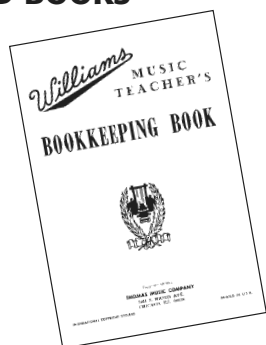

### WRIGHT-WAY NOTE FINDER A Visual Note Trainer

Many teachers consider the NOTE FINDER an indispensable training aid. Moving the note up and down and grand staff commands instant and complete attention, and demonstrates the basic note reading concepts. Size 6" x 8". .....**\$11.00**

### MANUSCRIPT BOOKS

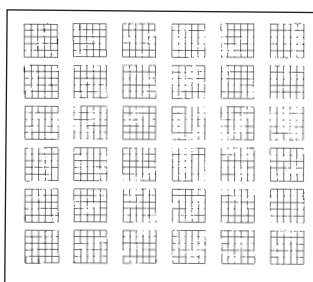

#### MUSIC WRITING, BOOK NO. 1

6 fret chord book, 24 pages, 9" x 8" .....**75¢**



#### CURTIS KEYBOARD CHART

Four octave range. Printed on heavier card stock, for use at desks or at the keyboard .....**\$2.00**

**BUCK'S COMPLETE KEYBOARD CHART**.....**2.95**

**THOMAS PIANO "NOTE-FINDER" CHART**.....**2.75**

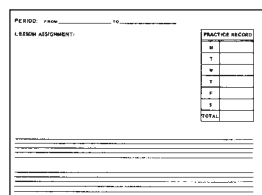

### WRIGHT-WAY PRACTICE RECORD BOOK

This inexpensive record book has a bright red color and 28 pages for LESSON ASSIGNMENTS and daily PRACTICE RECORD. Two staves are also provided for writing special exercises, note drills, scales, chords, etc. The inside back cover contains spaces for recording "MUSIC I HAVE MEMORIZED". Size 6" x 4-1/2" .....**85¢**

# iPAD & TABLET HOLDERS

## DUNLOP



Attach to the front of your guitar for mobility or when space is limited. The high-power suction cup will hold firmly to any non-porous surface -- stick it on your coffee table or computer desk.

- D36** Sturdy Stand Sheet Music Holder.....\$53.55
- D42P** iPad 2 - Pillar.....71.35
- D41MS** iPad 1 - Mic Stand.....61.15
- D42MS** iPad 2 - Mic Stand.....61.15
- D65** iPhone/iPod/iPod Touch Sturdy Stand.....53.53

## MANHASSET / HERCULES



- MANHASSET**  
Spring-loaded arms firmly grip iPad; unique 360 degree rotation features quick switching between portrait and landscape modes; tilt mechanism permits one-handed adjustment of viewing angle; shaft-base combination can be positioned from 32"-55" high.
- M3200** iPad Holder (attaches to Music Stand).....\$106.67
  - M3200M** iPad Holder (attaches to Microphone Stand).....111.67

- HERCULES**  
Versatile design fits tables from 8.9-10.1"; 360 degrees ball-joint design; fully-covered one-piece clamp fits 15.8-25.4mm (0.62-1") round tubes and 19mm (0.75") square tubes; detachable table support is included for desk top use; works in both landscape and portrait modes.
- HA300** iPad Holder.....\$59.99

## K&M



- iPAD HOLDER**  
Attaches quickly and easily to tubes up to 1.181" diameter; iPad snaps in or out effortlessly; freely rotates 90 degrees; can rapidly be switched between vertical and horizontal formats; for 2nd, 3rd or 4th generation.
- KM19722** ..... \$89.99

- TABLET PC STAND HOLDER**  
A universal tablet holder for mic stands; unique tensioning mechanism with a clamping width between 120 and 220mm means the holder can securely hold all standard tablet PC models like iPad, iPad mini, Amazon Kindle, Samsung Galaxy Tab, Google Nexus, etc.; also suitable for tablets in protective covers; freely rotates 90 degrees
- KM19742** ..... \$74.99

## ON STAGE



The mount and the leather-like case are one in the same; holds and protects full-size iPad generations 1, 2, 3, and 4 without hindering access or Wi-Fi reception; mounts to mic stands & other stage gear; aluminum mounting arm with solid steel ball-joint attachment, allowing tilt and 360 degree rotation; case can be removed and used independently; the iPad can be removed from the case while it's mounted to stand

- TCM9150** Tablet Mounting System.....\$65.99
- TS9900** Tablet Stand.....34.99
- TS9901** Tablet Stand.....39.99



- Lightweight, portable & ideal for holding laptop, CD player, EFX machine or lighting controller; 9.25"(w) x 10.8"(d), weight capacity 8 lbs; height adj.: 6.3-10.9"
- LPT5000** Computer Laptop Stand.....\$54.99
- Can stand alone on any flat surface for quick & easy set-up or clamp to virtually any table, rack case, etc., with 2 included mounting brackets; weight capacity 10 lbs; height adj.: 9.25-14.25", width adj.: 9.5-14.5", depth adj.: 12"
- LPT6000** Multi Purpose Laptop Stand w/ 2nd Tier.....\$84.99

## MIC-EZE



### Holders and Stands for all iPads and all Tablets

The EZ05/05A & EZ06/06A are designed to fit the vast majority of all available tablets mounted in either portrait or landscape mode; 360 degree rotation with 180 degree arm swing; unlimited positioning.

Model	Style	Mount	Grip Opening	Price
<b>MICEZ05</b>	8 Adj Legs	Universal Clamp	6.0"-8.25"	<b>\$62.99</b>
<b>MICEZ05A</b>	8 Adj Legs	Microphone Stand	6.0"-8.25"	<b>\$52.75</b>
<b>MICEZ06</b>	Quick Release	Universal Clamp	5.5"-8.25"	<b>\$72.45</b>
<b>MICEZ06A</b>	Quick Release	Microphone Stand	5.5"-8.25"	<b>\$62.25</b>
<b>MICEZ10</b>	10" Stand	Table Mount	5.5"-8.25"	<b>\$137.00</b>
<b>MICEZ11</b>	4" Stand	Floor Mount	5.5"-8.25"	<b>\$244.00</b>

# MANHASSET STANDS & ACCESSORIES

## SYMPHONY



Symphony Stand desk is 20" wide x 12½" high. Varies infinitely from 26" to 48" (lip to floor), with a maximum overall height of 60½ inches.

- M48 .....\$67.86
- M4801 Individually Boxed.....79.71
- M48TALL 38" - 60" .....86.28
- M8101 Harmony V-Shape Base  
26"-48" ABS Desk.....101.73
- M8106 V-Shape Base 26"-48" ABS Desk...93.78
- MAN48TP Trombonist Stand .....90.21  
(Designed to offset to either side)

## CONCERTINO



A shorter version of the Symphony Stand, with a vertical extension of 16" to 28" (lip to floor), with a maximum overall height of 40½ inches.

- M48C .....\$67.86
- M81C Harmony V-Shape Base ABS Desk ....93.78
- M81CA Harmony V-Shape Base ABS Desk ..101.73

## DIRECTOR



A must for every director. Unique, double-desk construction provides easily accessible music storage. The vertical extension and desk dimensions are identical to the Symphony Stand.

- M49 .....\$103.77

## ORCHESTRAL



Designed especially for concert orchestras. Double lip provides convenient storage for bows, rosin, pencils, reeds, valve oil, and more. The vertical extension and desk dimensions are identical to the Symphony Stand.

- M50 .....\$84.27
- M50CA Concertino .....84.27

## FOURSCORE



A one-piece desk that measures 32" wide — enough room to hold 4 pages of music. Ideal for groups, private studios, conductors, and more. The vertical extension is identical to the Symphony Stand.

- M51 .....\$85.29

## VOYAGER



Desk (20" wide x 12½" high). Varies infinitely from 26" to 48" (lip to floor), with a maximum overall height of 60½ inches. Fold up base.

- M52 .....\$94.08
- MAN1800 Tote Bag .....31.44

## VOYAGER CONCERTINO



A shorter version of the Voyager Stand, with a vertical extension of 16" to 28" (lip to floor), with a maximum overall height of 40½ inches.

- M52C .....\$94.08
- MAN1800 Tote Bag .....31.44

## REGAL CONDUCTOR



This double-shafted stand has a wide and extremely stable base. The desk (32" wide by 15¼" high) is capable of holding the larger scores. With its built-in accessory ledge and storage pocket (behind the desk), the "Regal" provides the optimum convenience and functionality.

- M54 .....\$183.06

## SYMPHONY COLOR



Add excitement to your band room or individualize music settings by infusing the brilliance of COLOR.  
In colors specify:  
(R) Red, (B) Blue,  
(G) Green, (O) Orange,  
(W) White, (Y) Yellow,  
(GR) Gray, (PU) Purple,  
(PI) Pink  
(Individually Boxed)

- M4801 Specify Color .....\$86.28

## TABLE TOP



Ideal for classroom, private studio, bellchoir, and more! Rubber foot on back support and felt pads located beneath the lip prevent any scratching of tabletop or other surface.

- M53 .....\$45.66

## WALL



Mounts on wall.

- M5601 .....\$57.15

## ACCESSORIES

- M4802 Desk for M48, complete .....\$33.09
- M4902 Desk for M49, complete .....61.11
- M5002 Desk for M50, complete .....41.91
- MAN5202 Desk for M52 .....41.91
- MBASE Base for M48, M49, M50.....25.50
- M5203 Base for M52C .....39.06
- MSHAFT Shaft for M48, M49, M50, Complete ..30.24
- M69T Tall Shaft.....31.05
- M1670 Tightening Tool; Metal .....14.82
- MAN1700 Floor Protectors (3) .....7.38
- M70 Conversion Kit, incl. M71 and M72 .....9.87
- M71 Base Cup Washer.....3.51
- M72 1¼" Cap, screw .....2.31
- M74 Desk neck swivel joint.....13.65
- M90 Accessory shelf .....12.78
- M91 Stand Outs .....12.30 ea.
- MCL Music Clip.....14.82 ea.
- MF52 Fourscore folder extends desk to 34" ..19.80
- M5216 M52 Neck Assembly.....13.80
- MAN2000 Sound Shield .....155.94
- MAN2400 Shaft Lock.....11.94
- MAN2600 Table Lock .....11.94
- MAN2800 Stand Accessory Box.....28.53
- M8102 Desk for M81C .....39.55
- M8103 Base for M81C .....28.68
- M53D Drummer Stand (see page 152) .....92.43
- M53DH Hi Hat Music Stand .....102.55

## STORAGE CART



Holds up to 25 concert-music stands, and is built to allow easy racking and removal of music stand. Rugged and durable zinc-plated, welded steel construction, 43" high, 22" wide, and 92" long.

- MAN1910 .....\$716.01
- MAN1920 Holds 13 .....501.54
- MAN1921 6" Plastic Wheel F/MAN1910.....15.33
- MAN1924 Swivel Casters F/MAN1910 .....17.33
- MAN1980 Harmony Cart Holds 15 .....501.54

DROP SHIPMENTS ARE AVAILABLE F.O.B. FOR YAKIMA, WA.

## HAMILTON STANDS

### DESK STAND

**KB70** .....\$14.99

### FOLDING STAND

Economy-priced quality folding music stand in fine chrome plate. Popular 2-section design. Fixed angle desk folds to 21½", extends to 55".

**KB400N** .....\$19.99

**KB400BK** Black .....\$17.99

**KB12** Bag for KB400 .....6.99

### FOLDING STAND

1 Section. 20½" - 52" with Bag

**KB900N** Chrome .....\$26.99

**KB900BK** Black .....\$25.99

### FOLDING STAND

Automatic Clutch Folding Stand, Black, w/Carrying Bag, 3 Section.

**KB200CB** .....\$13.99

**KB200** Same as KB200CB, No Bag .....12.99

### FOLDING STAND

For use where space is at a premium. Solid steel desk with fixed angle - 21"W x 14½"H.

**KB50** .....\$60.99

**KB14** Bag .....\$36.00

### CONDUCTOR'S STAND

Designed with the special requirements of the school and concert conductor in mind. Desk measures 31½" wide by 14½" high. Full desk angle and height adjustment.

**KB300A** .....\$166.99



KB400N

## MUSIC STANDS

### FOLDING STAND

3 section, steel construction w/bag

**SM030** Black .....\$15.80

### STAGELINE FOLDING STAND

2 section nickel plated.

**MS1050N** .....\$19.99

**MS1050BK** Black .....19.99

**W963061** Shelf Extender .....10.75

### STAGELINE TUBULAR STAND

Three Section Stand constructed of heavy duty tubing.

**MS25BKB** Black w/Bag .....\$34.20

### HAMILTON ORCHESTRA STAND

25" Desk

**KB990BK** Black .....\$61.99

**KB90** Traveler w/bag .....\$84.99

### ORCHESTRA STAND

Steel desk with cutouts, angle adjustable tubular folding tripod base.

**MS5** Black .....\$64.99

**SM051** Black .....\$39.15

**MUS439** Black .....\$63.35



MS5

## HAMILTON STANDS



KB1D

**KB1D GRIPPER.** Built to stand up years of use. 20 gauge steel desk, 16 gauge chrome-plated steel tilt plates, 1" and 1⅝" steel tubing and heavy, stamped bases .....\$75.99



KB1E

**KB1E AUTOMATIC.** Long-lasting beauty. Charcoal grey, 2 component enamel is baked on and inside tubing is chrome plated .....\$76.99



KB1F

**KB1F TRIGGER.** Durable construction. Lower tube is welded to a heavy flange which is bolted through the tripod base. Excellent stability. Base has lower center of gravity. No tipping, no side sway .....\$88.99



KB95D

**KB95E ENCORE.** Desk has rolled edges for added strength and safety. Precision clutch mechanism for quiet telescoping action. Guaranteed to hold up to 8 pound .....\$66.99  
**KB95D** Gripper .....\$61.99  
**KB95FP** Floor Protectors .....\$3.00/3  
**KB95ES1** Double Shelf .....\$71.99

## STAND BAGS



**BS10B CARRYING BAG.** Designed for use with the KB2 and KB600N stands .....\$5.50

**BS12B CARRYING BAG.** Designed for use with KB400N .....\$5.95

**MS101NY** Nylon .....\$8.90

**SMSB6500** A Durable Black Canvas Bag with Handle (On/Stage) .....\$11.99



### EXTRA SHELF STAND

This added shelf is felt lined for quiet storage of bows, pencils, etc.

**KBIFS** .....\$106.99

ASK ABOUT DROP SHIP PRICING

## HAMILTON CART



Holds up to 25 Concert Music stands. 49" high, 24" wide, 55" long.

**KB100** .....\$543.00

## K & M MUSIC STANDS



<b>KM107</b>	Special Music Stand .....	<b>\$119.99</b>
<b>KM10010*</b>	Rainbow Series Music Stand .....	<b>35.99</b>
	*Specify (B) Blue, (BK) Black, (W) White, (R) Red, (G) Green, (Y) Yellow, (PU) Purple, (PI) Pink, (RB) Rainbow	
<b>KM10062</b>	Robby, Black .....	<b>79.99</b>
<b>KM37850</b>	Ruka Folding, Black, w/bag .....	<b>47.50</b>
<b>KM12155</b>	Laptop Tri Pod Stand .....	<b>124.99</b>
<b>KM10065BK</b>	Music Stand, Black .....	<b>69.99</b>
<b>KM101</b>	Music Stand .....	<b>35.99</b>
<b>KM101BK</b>	Black Music Stand .....	<b>35.99</b>
<b>KM1181</b>	Orchestra Stand, Wood Desk .....	<b>229.99</b>
<b>KM11888BK</b>	Orchestra Music Stand .....	<b>189.99</b>
<b>KM10012</b>	Bag, Fits KM1006, KM10010RB .....	<b>10.99</b>
<b>KM10111</b>	Bag, Fits KM101 .....	<b>12.49</b>
<b>KM10711</b>	Bag, Fits KM107 .....	<b>29.99</b>
<b>KM1152</b>	Music Holder, Clamps on stand, Metal Dek .....	<b>54.99</b>
<b>KM1221</b>	Wooden Tray (Walnut) .....	<b>59.99</b>
<b>KM124</b>	Table Music Stand .....	<b>29.99</b>
<b>KM131</b>	Music Holder .....	<b>34.99</b>
<b>KM16092</b>	Pencil Holder (Fits 13-15 mm Tubes), Fits KB400N .....	<b>1.99</b>
<b>KM16094</b>	Pencil Holder (Fits 20-22 mm Tubes), Fits M48 .....	<b>1.99</b>
<b>KM16096</b>	Pencil Holder (Fits 24-26 mm Tubes) .....	<b>1.99</b>
<b>KM16060</b>	Music Clips (4) .....	<b>7.49</b>
<b>KM11580</b>	Power Magnets Page Holders .....	<b>9.49/2 pk.</b>

## ON/STAGE MUSIC ORCHESTRA STANDS



<b>SM7211B</b>	Conductor Stand with Tripod Folding Base .....	<b>\$81.99 ea.</b>
<b>SM7122BB</b>	Compact Sheet Music Stand, Black with Bag .....	<b>26.99 ea.</b>
<b>SM7122B</b>	Compact Sheet Music Stand, Black .....	<b>19.99 ea.</b>
<b>SM7122NB</b>	Compact Sheet Music Stand, Nickel with Bag .....	<b>27.99 ea.</b>
<b>SM7122N</b>	Compact Sheet Music Stand, Nickel .....	<b>19.99 ea.</b>
<b>SM7222B</b>	Tubular Tripod Base Sheet Music Stand, Black .....	<b>36.99 ea.</b>
<b>SM7222BB</b>	Tubular Tripod Base Sheet Music Stand, Black, w/Bag .....	<b>37.99 ea.</b>
<b>SM7022BB</b>	Sheet Music Stand w/Bag, Black .....	<b>19.99 ea.</b>
<b>SMSB6500</b>	Sheet Music Bag .....	<b>11.99 ea.</b>

### COLOR STANDS

<b>SM7122DBB</b>	Sheet Music Stand with Bag – Dark Blue .....	<b>\$26.99 ea.</b>
<b>SM7122GRB</b>	Sheet Music Stand with Bag – Green .....	<b>26.99 ea.</b>
<b>SM7122RDB</b>	Sheet Music Stand with Bag – Red .....	<b>26.99 ea.</b>
<b>SM7122PKB</b>	Sheet Music Stand with Bag – Pink .....	<b>26.99 ea.</b>
<b>SM7122PVB</b>	Sheet Music Stand with Bag – Purple .....	<b>26.99 ea.</b>

## PETERSEN STANDS



Lightweight, durable, adjustable angle desk. Height adjustable, components store in desk for portability.

<b>P2K</b> .....	<b>\$65.85</b>
<b>PKBAG</b> Bag .....	<b>29.95</b>

### CONDUCTOR



Black tripod stand with extra large desk.

<b>MS6</b> .....	<b>\$72.00</b>
------------------	----------------

### TUBULAR



Black tripod stand with heavy duty solid steel desk.

<b>MS4</b> .....	<b>\$64.99</b>
<b>MS3F</b> .....	<b>59.00</b>
<b>SM050</b> .....	<b>38.20</b>
<b>YAMAHA</b>	
<b>YMS5000</b> Adj. 24"-45" .....	<b>\$66.60</b>

## QUIKLOK



Heavy-duty orchestra sheet music stand with removable wood music holder. Black metal with cherry wood top.

<b>AMSMS332</b> .....	<b>\$79.99</b>
-----------------------	----------------

## STAGELINE

### COLOR



2 section folding stand.

Available in:	
(PUR) Purple, (DBL) Dark Blue	
<b>MS2</b> .....	<b>\$20.99</b>

## STRUCTURE

### COLOR



### FOLDING STAND

2 Section Stand. Available in (P) Plum, (R) Red, (B) Blue, (W) White, (BK) Black

<b>SMS1</b> .....	<b>\$15.75</b>
-------------------	----------------

# HERCULES MUSIC STANDS



BS311B



BS301B



BS500X



BS418B



BS100B

- New "EZ-Clutch" design is reliable and easy to use
- Desk: 18.9" x 13.6"
- Height: 26.7" – 45.2"
- Weight: 6.71 lbs.
- Folded size: 27.8" x 6.7"

**BS311B**.....\$125.99

- Wider height adjustment range is ideal for practice and on stage performance.

- Foldable Desk
- Quik-N-EZ Retainer
- EZ Angle Roller
- Quik-N-EZ Height Adjustment Grip

**BS408B** Solid Desk.....\$125.99

**BS418B** Holes Desk .....125.99

**The BS500X Home Series music stand** features a sturdy design for holding plenty of sheet music

- EZ-Glide height adjustment
- Tilting desk

**BS500X**.....\$202.99

- Aluminum folding desk
- Page retainer
- All new EZ Clutch
- Tilting base, angles between 90-75 degrees
- Open taps on legs to insert instrument peg stands
- Low profile height
- Desk: 18.9" x 13.6"
- Height: 26.8" – 45.3"

**BS301B**.....\$129.99

With the one-handed EZ Grip, adjusting height while holding your instrument in hand is a breeze. BS118BB also provides sturdy support in a lightweight structure. A carrying bag is included for portability. Desk size: 21 x 11.5", Height: 21.7-48.4", Weight: 3.7 lbs., Folded size: 20.5 x 4.3".

**BS118BB** 3-section.....\$64.99

- Frictioning EZ Angle Roller
- Clutchless Grip
- Height: 27.1" - 48.4"
- Desk: 21" x 11.5"

**BS100B**.....\$59.99

## Hercules Symphony Stand

Featuring a one-handed EZ Grip. Adjusting the height while holding your instrument is a breeze. Desk size: 18.9" x 13.6". Height: 27.2" x 43.3". Weight: 7.5 lbs.

**BS200B** .....\$64.95

## Hercules Carry Cart

Music Stand Cart carries up to 12 pieces of BS200B, definitely the best selling tool.

**BSC800** .....\$299.95



**Padded Music Stand Carry Bag**  
Fits 300 and 400 Series.

**BSB001** .....\$36.99

**Padded Music Stand Carry Bag**  
Fits BS100B.

**BSB002** .....\$21.99

## Music Holder

**AMSMS303** Clamp on Shelf ..\$33.32

## MUSIC CLIPS



**4075** .....\$ 7.95

**MCL** Manhasset .....14.82

**AIM9400** The Solution.....5.95

**KM11580** Power Magnets  
Page Holders.....9.49/2 pk.

## STAFF LINER



**9100** Blackboard staff liner .....\$7.00

## TELLENO OCTAVO & SHEET MUSIC COVERS



Fiber board covers with leatherette binding on all edges. Pockets are reinforced to prevent tearing. Bottom pockets.

**DR11** Black 9 x 12 .....\$4.95

**DR34** Black 12 x 14 .....6.00

Deluxe covers with metal corners. Pockets have expandable 1/2" gussets. Bottom pockets.

**DR71** Black 12 x 14.....\$18.15

**DR73** Black 12 x 14 with pen pocket .....19.80

**DR30** Black 9 x 12 .....15.00

**DR47** Metal Ring.....1.50

## MAESTRO'S MATE™

Multi-page music reader secures and protects sheet-music from the wind and rain, is great for bands and orchestras.

**MM1**.....\$22.50B

## G.I.A. CHORAL FILING BOXES



Made of tough corrugated board with a smooth white finish the boxes can be written upon to organize your library. Cut-outs permit easy removal of contents. All boxes are 11" long and 7 1/2" high.

Width	Box	Cover
1 1/4"	GIAB1 .....1.25B	GIAC1.....48B
2"	GIAB2 .....1.35B	GIAC2.....58B
3"	GIAB3 .....1.50B	GIAC3.....74B
5"	GIAB5 .....1.70B	GIAC5.....85B
12 1/2" x 9"	GIAB9 .....1.80B	GIAC9.....95B
	(GIAB9: 12 1/2 x 9 1/2 x 2 1/2)	

## TELLENO CHORAL FOLDER



Capacity for over 150 pages. Attractive vinyl stiff board cover. Pockets provided on the front and back inside covers for additional storage of music.

**450R**.....\$ 8.10

**MFCH** Manhasset .....22.47

## MARCHING BAND FLIP FOLDERS



FFI



DEG



TROPHY



CONN

## CORDER

This durable flip folder is designed for easy manipulation of the windows.

**FF1** w/five pockets .....\$5.60

**FF2** Extra Pockets ..... .67

**FF4** Extra Rings ..... .47

## DEG

**DEGHC200** Five Pockets .....\$6.25

**DEG69110** Extra Pocket ..... .55

**DEG69120** Extra Ring ..... .75

## TROPHY

**TR9400** Five Pockets .....\$5.25

**TR9401** Extra Pocket ..... .55

**TR9402** Extra Ring, Metal .... .40

## CONN

**CG5885** Five Pockets .....\$6.88

**CG588W** Extra Pocket ..... .71

**CG588R** Extra Ring Metal ..... .59

## BELMONTE

**64165** Five Pockets .....\$7.30

**6417** Extra Pocket ..... .95

**6418** Extra Ring ..... .28

# HOUSE OF TROY LAMPS



Slimline grand piano lamp. Virtually eliminates shadows. w/bulb

**GPXL2261** Brass .....\$344.00B  
**GPXL617** Black neck.....368.00B  
**15T4** Bulb (4 per pack) .....15.00B



Polished brass finish. Heights adjusts from 0" to 16". 14" shade 6 3/8" decagonal base.

**P14212** .....\$240.00B



Polished brass base and 14" Grand Piano Lamp.

**GP1461** .....\$138.00B  
**GP147** Same as above in black .....128.00B



Polished brass finish. Heights adjusts from 0" to 12". 14" shade. 6" diameter base.

**P14231** .....\$198.00B



Polished brass finish. Heights adjusts from 3 1/2" to 11". 10" shade. 5" diameter base.

**P10130** .....\$164.00B



Polished brass finish. Heights adjusts from 0" to 10 1/2". 10" shade. 5" diameter base.

**P10131** .....\$176.00B



Polished brass & black. Height 18", 14" shade. 3 1/2" x 7" Base.

**P14D01** .....\$224.00B

**10" Shade = 1 Bulb**  
**14" Shade = 2 Bulbs**  
**15" Shade = 2 Bulbs**



Polished brass.

**P14250** 14" Shade, 2 Bulb .....\$216.00B



Cordless lamps ideal for pictures. Operate on 4 AA batteries; 3 point adjustable. w/bulb

**AB761** Polished Brass .....\$48.00B  
**AB771** Antique Brass .....48.00B



Satin brass finish, height adjusts from 14" to 18", 5 1/2" round base, 15" shade.

**P158051** .....\$224.00B



Polished brass with crystal base. 10" adjustable shade.

**P1019161C** .....\$410.00B  
**P1019161M** Black Marble Base .....410.00B



Polished brass, height adjusts from 2" to 15", 6 1/4" round base, 14" shade.

**P14204** .....\$224.00B



# HOUSE OF TROY LAMPS



Polished brass and marble lamp with 10" shade. Height adjusts from 5" to 22", 5" square base.  
**P10190M .....\$374.00B**



Polished brass with marble base. 10" shade adjusts from 6" to 12", 4" square base.  
**P10101B .....\$198.00B**



Polished brass lamp with 5" octagon base. 10" shade. Adjusts 4" to 10½".  
**P1010761 .....\$188.00B**



Polished brass lamp with brass shade. Octagon base, 10" shade adjusts 0" to 14".  
**P10111 .....\$196.00B**



Polished brass lamp with 14" shade, 6" square brass base adjusts 0" to 14".  
**P14201 .....\$224.00B**  
**P14201AB Antique Brass.....\$232.00B**



Polished brass lamp with 14" shade. 5" square brass base adjusts 0" to 13".  
**P14202 .....\$224.00B**  
**P14202AB Antique brass.....\$232.00B**

**10" Shade = 1 Bulb**  
**14" Shade = 2 Bulbs**  
**15" Shade = 2 Bulbs**



Antique brass & chestnut bronze, adjusts from 0" to 16½", 5½" square base, two 40T10 or 60T10, on base switch, 14" shade, 9' brown cord.  
**P14233C71 .....\$234.00B**  
**P14233617 In Black w/Brass Polished Accents.....\$224.00B**



Polished brass.  
**P10150 10" Shade, 1 Bulb .....\$199.00B**



Polished brass lamp with 14" shade, 6: Octagon brass base adjusts 0" to 12½".  
**P14203 .....\$224.00B**  
 Antique brass, 14" shade, 6" round base, adjusts 0" to 12".  
**P1423171 .....\$206.00B**

# HOUSE OF TROY

## ADVENT PIANO LAMPS



**AP102061** Polished Brass .....\$110.00B

### GRAND PIANO LED

**ALED157** .....\$78.00B



**AP102161** Polished Brass .....\$150.00B

**AP102171** Antique Brass .....\$144.00B



**AP144071** Antique Brass .....\$140.00B

## ARIA



**AP144161** Polished Brass .....\$165.00B

**AP144171** Antique Brass .....\$156.00B



High-intensity LEDs provide brighter, more even light with 5% of the power. No bulbs to replace. Stays cool. Fits all solid desk stands. Aluminum. 14" wide. 9 ft. cord. Power supply included.

- Solo** 2 watts .....\$69.95
- Diva** 4 watts .....\$89.95
- BRIO** Rechargeable LED .....\$169.99
- ARIABT1** Brio Battery .....\$39.95B
- E1** Cord extender (6 foot) .....\$19.99



**AP1442** Polished Brass .....\$165.00B

## CLIP LIGHTS



### BANDSTAND

Fits folding stands, dance band stands.

**BLS1** w/o Bulb .....\$29.95

**A40** 40 Watt Bulb .....\$3.45B

## MANHASSET



Provides full width illumination without glare. Attaches to any Manhasset stand. Includes 40 watt bulb. Stand desk not included.

- M57** Manhasset .....\$38.04
- M1050** Manhasset LED Black Plastic .....\$65.70
- BLS2** Orch Stand Light ASB .....\$31.00

## BULBS

**A40** 40 Watt .....\$3.45B

**F25** 25 Watt .....\$7.40B

**PL13** Fluorescent .....\$11.60B

## LED LAMPS



Polished brass finish, adjustable height, 4 1/2" arm ext., 5 1/2" x 2 1/2" felt-lined clamp adjusts to 3/4", LED bulb, 26" shade.

**GPLED2661** .....\$400.00B

Black w/brass accents, 19" shade.

**GPLED197** .....\$230.00B

Upright black w/brass accents, 19" shade.

**PLED101617** .....\$258.00B

# MIGHTY BRIGHT



Two white, energy-efficient LEDs. Illuminates for improved night vision. Durable LEDs lessen eye strain and never need replacing. Precisely engineered optical grade lens spreads light evenly. Flexible gooseneck holds light in place. Folds into ultra-compact shape. Fits any standard USB port – a DJ's favorite! No batteries required. 13.75" x 0.25" x 0.5" (Length x Height x Width)  
**84312 LED USB White Light.....\$14.99**



Nine bright white energy-efficient LEDs. Each LED lasts 100,000 hours. Two brightness levels. 11.7" lamp precisely engineered optical grade lens spreads light evenly. Flexible gooseneck. Broad padded clip. Stable free-standing base. Durable travel bag. 20 hours of battery life (low setting); 14 hours (high). 3 AA batteries (included). AC adapter with 13 foot/4 meter power cord (included).  
**53510 Orchestra Light .....\$78.70**



**GEARHEAD HEADLAMP**  
 Single LED casts even white beam throughout the field of vision. Durable LED lasts 100,000 hours, no replacement necessary. Push button switch control three lighting modes (high, low, and flashing). Hold down the on/off switch to change to the flashing light mode. Precisely engineered optical grade lens spreads light evenly. Adjustable head-band holds the light in place. Lightweight – only 2.2 oz. Beam distance 50 meters. Powered by 2 AAA batteries (included). 2.5"L x 1.5"H x 1.5"W.  
**90515 Blue .....\$24.99B**  
**90516 Gray .....24.99B**



Six LEDs cast bright white light. 3.75" lamp precisely engineered optical grad lens spreads light evenly. LEDs never need replacing. Sturdy clip grips almost anything, or base can be used free standing. Adjustable gooseneck holds the light in place. Light easily folds for convenient storage. Powered by 3 AAA batteries (included) or optional AC adapter. Includes black gig bag.  
**54810 HammerHead Music Light, Black \$26.25**



Six LEDs cast bright white light. 8" lamp precisely engineered optical grad lens spreads light evenly. LEDs never need replacing. Sturdy clip grips almost anything, or base can be used free standing. Adjustable gooseneck holds the light in place. Light easily folds for convenient storage. Powered by 3 AAA batteries (included) or optional AC adapter & bag.  
**54910 Encore Music Light.....\$47.25**



An extremely flexible LED light for your music stand or low light situations.  
**XF Extra Flex (BK) (SI) .....\$15.75**



Telescoping arm for maximum adjustability. Long life LEDs never need replacing. LED lenses focus bright light evenly.  
**MBBL3 Triple LED.....\$26.40**  
**LEDAC AC Adaptor .....10.50**



Dual flexible arms provide infinite maneuverability. Two lighting heads, each containing two Super LEDs. Uses 3 AAA batteries (included).  
**XFDUET Dual XF.....\$26.90**  
**XFDUET2 w/AC Adaptor.....42.00**



Two energy-efficient LEDs cast bright white light. Durable LEDs last 100,000 hours – no replacement necessary. Use one or two LEDs by tapping button. Precisely engineered optical grade lens spreads light evenly. Sturdy clip. Adjustable gooseneck holds the light firmly in place. Base can be used free-standing. Powered by 3 AAA batteries (included) or optional AC adapter (sold separately)  
**XF2 Extra Flex 2 LED .....\$20.99**

## ASK ABOUT OUR MUSIC DEPARTMENT

**FAX & E-MAIL ORDERS FOR PRINTED MUSIC WILL GET AN EXTRA 5% DISCOUNT**

**FAX:  
 (708) 496-2130 • (888) 983-5537**

**E-MAIL:  
 sales@harristeller.com**

## MAESTRO



**9900 Maestro.....\$39.95B**  
**MBAG Maestro Bag .....20.25**

## HOUSE OF TROY



Black finish, 5 1/2" height, 4 1/2" arm ext., 4 1/2" x 3" x 1 1/4" base, LED bulb, 12 1/2" shade, battery operated 4C (not included), illuminates 48 hours.  
**CBLED127 .....\$144.00B**

## USUAL PRINT DEALER DISCOUNT ON THESE TECHNICAL AND INFORMATION FILLED BOOKS FOR THE MUSIC STORE AND MODERN MUSICIAN

### DRUMS & DRUM MACHINES

**COMPLETE PERCUSSIONIST** – R. Breithaupt – Guidebook for the music educator. Spiral bound, revised second edition. **\$29.95**

**THE CYMBAL BOOK** – H. Pinksterboer – This book takes an in-depth look at the 5000-year history, development and details of these fascinating instruments. **\$24.95**

**THE DRUM BOOK** – G. Nicholls – A history of the rock drum kit. Hard cover. **\$24.95**

**DRUM KIT HANDBOOK** – Balmer – How to buy, maintain, set up, troubleshoot & modify your drum set. HC. **\$27.00**

**DRUM HANDBOOK** – G. Nicholls – Buying, maintaining, and getting the best from your drum kit. **\$24.95**

**DRUM RECORDING HANDBOOK** – Owsinski/Moody – Secrets of great drum sounds revealed. Bk/DVD. **\$29.95**

**DRUMMER, THE** – Modern Drummer Magazine – 100 years of rhythmic power and invention. HC. **\$27.95** / Paperback Ed. **\$22.95**

**GRETSCH DRUMS** – C Falzerano – Covers the legacy of "That Great Gretsch Sound." Includes photos, interviews and history. **\$34.95**

**GUIDE TO VINTAGE DRUMS** – J. Aldridge – Essential guide for collectors-to-be that want to shop around or for current collectors. **\$24.95**

**HOW TO SET UP YOUR DRUMSET** – D. Black – Most complete reference guide available. **\$4.95**

**HOW TO TUNE YOUR DRUMS** – D. Black – Everything you need to effectively and consistently tune your drum set. **\$5.50**

**INSIDE OUT** – B. Ward – Exploring the mental aspects of drumming. **\$12.95**

**KRUPA, GENE** – Klauber – Pictorial life of a jazz legend. Bk/CD. **\$26.95**

**LUDWIG BOOK, THE** – R. Cook – A business history and dating guide. Includes CD. **\$35.00**

**MAKING OF A DRUM COMPANY** – Autobiography of William F. Ludwig II. **\$19.95**

**MIND MATTERS** – Schallehn – Overcoming common mental barriers in drumming. **\$12.95**

**MR. LEEDY & THE HOUSE OF WONDER** – Cangany – Story of the World's Finest Drums. **\$24.95**

**MUSIC ALIVE'S PERCUSSION** – Glass – Well-illustrated guide to all forms of percussion. w/DVD. **\$19.99**

**MUSICIAN'S GUIDE TO RECORDING DRUMS** – D. Beck – Learn how to get a professional sound when recording drums in the studio and on stage. Includes CD. **\$19.95**

**PRODUCING DRUM BEATS** – Hawkins – Writing & mixing killer drum grooves. Bk/CD. **\$22.99**

**RECORDING DRUMS: THE COMPLETE GUIDE** – Major – Plenty of tips and techniques to get the best sound. **\$34.99**

**ROOTS OF ROCK DRUMMING** – Glass – Interviews with the drummers who shaped rock 'n' roll music w/ DVD. **\$29.99**

**SCORING FOR PERCUSSION** – Reed – Including all the instruments of the percussion family. Bk/CD-ROM. **\$24.99**

**SLINGERLAND BOOK, THE** – R. Cook – Complete history, with detailed information. **\$29.95**

**SOUND ADVICE ON RECORDING & MIXING DRUMS** – B. Gibson – Information, diagrams and a CD. **\$14.95**

**TIPBOOK DRUMS** – H. Pinksterboer – Basic book and reference guide. **\$14.95**

**ULTIMATE GUIDE TO CYMBALS** – N. Petrella – In-depth comparison and techniques. Includes DVD. **\$24.95**

**VINTAGE SNARE DRUMS – CURETTO COLLECTION VOL. 1** – Rare American snares 1900-1940's. Hardcover. **\$29.95**

**ZILDJIAN** – Cohan – Detailed history of the legendary cymbal maker. **\$19.95**

### ART OF RECORDING & SOUND

**AUDIO EFFECTS WORKSHOP** – Francis – How to understand and use audio effects in recording and post-production. Bk/DVD. **\$34.99**

**AUDIO FUNDAMENTALS** – Learn the basic tools and technology. Bk/DVD **\$39.99**

**AUDIO MADE EASY** – I. White – Practical info on how pro audio equipment works and how to use it to its fullest. Includes CD. **\$18.99**

**AUDIO MASTERING: ESSENTIAL PRACTICES** – Wyner – Improve the sound of your recordings. w/CD. **\$29.99**

**AUDIO RECORDING BASIC TRAINING** – Owsinski – Hands-on survival manual for musicians. w/DVD. **\$29.99**

**BASICS OF LIVE SOUND** – J. Slone – Beginner's guide to the basics of live concert sound mixing and microphone techniques. **\$14.99**

**BEGINNER'S GUIDE TO COMPUTER-BASED MUSIC PRODUCTION** – Z. Price – Record tracks on your home computer, create MIDI files, and master your own CDs. **\$19.95**

**BUSINESS OF AUDIO ENGINEERING** – Hampton – Tips for working in the real world. **\$24.95**

**COMPLETE PRO-TOOLS HANDBOOK** – Valenzuela – Step by step exercises with included CD-ROM. **\$49.95**

**DESKTOP STUDIO, THE** – Menasche – Guide to computer-based audio production. **\$27.99**

**ENGINEERING & PRODUCING** – B. Gibson – Learn to put the secrets all together. Bk/DVD. **\$39.95**

**GETTING GREAT SOUNDS: THE MICROPHONE BOOK** – Lubin – Learn the skills of choosing & using different microphone types. **\$39.99**

**GUERRILLA HOME RECORDING** – K. Coryat – Make your small home studio sound huge. **\$24.99**

**GUIDE TO SOUND SYSTEMS FOR WORSHIP** – J. Eiche – Assists in their design, purchase and operation. **\$24.95**

**HOME RECORDING BASICS** – B. Purse – Perfect for anyone who wants to expand their creative choices and knowledge while having fun with home recording. **\$10.95**

**HOME RECORDING FOR BEGINNERS** – Francis – Practical instruction on recording fundamentals. Includes CD-ROM. **\$34.99**

**HOME RECORDING HANDBOOK** – Hunter – Get great results without an expensive studio. HC/Spiral w/CD. **\$29.99**

**HOME RECORDING STUDIO BASICS** – What you need to know to build a home studio. **\$19.95**

**HOME RECORDING TIPS & TRICKS** – Strategies & solutions for your home studio. **\$12.95**

**HOME STUDIO ESSENTIALS** – Touzeau – Everything is covered, including recommendations. **\$29.99**

**HOUSE OF WORSHIP – SOUND REINFORCEMENT** – Rio/Bono – How to become a sound technician in a house of worship and beyond. **\$34.99**

**HOW TO MAKE YOUR BAND SOUND GREAT** – Owsinski – Follow the techniques professional musicians use to sound their best. Bk/DVD. **\$29.95**

**INSTRUMENT & VOCAL RECORDING** – B. Gibson – Detailed guide demonstrates how to create perfect tracks. Bk/DVD. **\$39.95**

**JBL STORY** – J. Eargle – 60 years of audio innovation. **\$29.95**

**LIVE SOUND FOR MUSICIANS** – R. Trubitt – Packed with easy step-by-step instructions... and what to do when things go wrong. **\$19.95**

**LIVE SOUND MANUAL** – Getting great sound at every gig, choosing the right gear, setting up & testing, miking, mixing & EQing, maintaining your equipment and understanding acoustics. **\$29.95**

**LIVE SOUND REINFORCEMENT** – S. Stark – Comprehensive guide to P.A. systems and technology. HC Bk/CD. **\$49.95**

**MICROPHONES & MIXERS** – Explores what to get and how to use it correctly. Bk/DVD. **\$39.95**

**MIXING & MASTERING** – B. Gibson – The magical final steps in the recording process. Bk/DVD. **\$39.99**

**MIXING IN PRO TOOLS – SKILL PACK** – Smithers – Understand the art & craft of creating great sounding mixes. With CD-ROM. **\$34.99**

**MUSICIAN'S GUIDE TO HOME RECORDING** – (Revised & Updated) P. McIan/L. Wichman – How professional recording techniques can be applied at home, from cassette portastudios to digital multitrackers. **\$24.95**

**101 RECORDING TIPS** – A. St.James – Stuff all the pros know and use, with 30 demo tracks on CD. **\$14.95**

## USUAL PRINT DEALER DISCOUNT ON THESE TECHNICAL AND INFORMATION FILLED BOOKS FOR THE MUSIC STORE AND MODERN MUSICIAN

**RECORDING TIPS FOR ENGINEERS** – Crich – Over 1,000 easy-to-use tips for cleaner, brighter tracks. **\$29.95**

**ROCKIN' YOUR STAGE SOUND** – Gainey – Musician's guide to professional live audio. **\$24.99**

**SOUND CHECK** – T. Moscal – The basics of sound and sound systems. An excellent primer for musicians, students and aspiring audio engineers. **\$14.95**

**SOUND REINFORCEMENT HANDBOOK** – G. Davis/R. Jones – Covers all aspects of designing and using such systems for public address and musical performance. **\$34.95**

**STUDIO BUILDER'S HANDBOOK** – Owsinski/Moody – Improve the sound of your studio on any budget. Bk/DVD. **\$39.99**

**STUDIO ESSENTIALS** – Hapke – Results-oriented instruction on the basics of recording, mixing, mastering and more. **\$17.99**

**TEACH YOURSELF MIXING** – Terry – Everything you need to know to start digital and analog mixing now. **\$14.99**

**ULTIMATE CHURCH SOUND OPERATOR'S HANDBOOK** – B. Gibson – Bk/DVD. **\$39.95**

**ULTIMATE LIVE SOUND OPERATOR'S HANDBOOK** – B. Gibson – Covers all aspects. Bk/DVD **\$39.95**

**UNDERSTANDING AUDIO** – Thompson – Getting the most out of your project. **\$24.95**

**YOUR SOUND ONSTAGE** – Menasche – Covers a broad range of musical situations and styles. Bk/CD-ROM. **\$29.99**

---

### GUITAR/BASS AND RELATED EFFECTS

---

**ACOUSTIC GUITAR** – T. Gerken – Historical look at its composition, construction and evolution. **\$18.95**

**ACOUSTIC GUITAR HANDBOOK** – Balmer – How to buy, maintain, set up, troubleshoot and repair your guitar. HC. **\$25.00**

**ACOUSTIC GUITAR OWNER'S MANUAL** – Complete guide. **\$17.95**

**ALL ABOUT VACUUM TUBE GUITAR AMPLIFIERS** – Weber – Everything you need to know about maintaining, repairing and modifying tube amps. **\$34.95**

**AMPED** – Hunter – Illustrated history of the world's greatest amplifiers. HC. **\$35.00**

**AMPS!** – Fliegler – The other half of Rock 'N' Roll. **\$24.95**

**BASIC GUITAR ADJUSTMENTS & SETUPS** – J. Boehnlein – An essential guide to guitar maintenance. **\$5.95**

**BASS BOOK** – Bacon/Moorhouse – Complete illustrated history of bass guitars. **\$24.95**

**BEATLES GEAR** – A. Babiuk – All the Fab Four's instruments, from stage to studio. **\$29.95**

**BEAUTY OF THE BURST** – Iwanade – Pays tribute to Gibson Sunburst, Les Pauls from '58 to '60. It features full-color photos and famous players. **\$34.95**

**BIGSBY, PAUL, THE STORY OF** – A. Babiuk – Father of the modern solid body guitar. HC w/CD. **\$50.00**

**BLUE BOOK OF ACOUSTIC GUITARS – 14th Ed.** – This is the largest, most comprehensive book ever published on acoustic guitars, with over 700 pages, 500-plus trademarks, 400-plus photos and over 20,000 prices! **\$29.95**

**BLUE BOOK OF ELECTRIC GUITARS – 14th Ed.** – This is the largest, most comprehensive book ever published on electric guitars containing over 1,150 pages, 1,000-plus trademarks. **\$39.95**

**BLUE BOOK OF GUITAR AMPLIFIERS – 4th Ed.** – Only publication that provides detailed information and up-to-date values on both new and vintage guitar amps. **\$29.95**

**BLUES GUITAR HANDBOOK** – St. James – Complete course in techniques and styles. HC Spiral w/CD. **\$29.99**

**BUILD YOUR OWN ACOUSTIC GUITAR** – J. Kinkead – All aspects of construction are fully covered. Each step is clearly photographed in color, with instructions and full-sized plans. **\$29.95**

**BUILD YOUR OWN ELECTRIC GUITAR** – Balmer – Easy to use manual for assembling a custom guitar from pre-built components. HC. **\$34.95**

**CHARVEL, WAYNE/LEGEND** – Green – History of this guitar designer and manufacturer. Bk/CD. **\$24.99**

**CLASSIC ELECTRICS** – W. Carter – Visual history of great guitars. **\$14.95**

**CLASSICAL GUITAR PEDAGOGY** – A. Glise – Handbook for teachers. **\$35.00**

**The COMPLETE GUIDE TO GUITAR AND AMP MAINTENANCE** – R. Fliegler – Fully illustrated, easy-to-follow handbook, written in plain English - for guitarists who want to take things into their hands. **\$16.99**

**COMPLETE GUITAR REPAIR** – H. Kamimoto – Tells you everything you need to know about the maintenance, restoration and construction of acoustic and electric guitars. **\$27.95**

**CONSTRUCTING A SOLID BODY GUITAR** R. Siminoff – The necessary drawings, instructions, and photographs to build a solid-body electric guitar. **\$22.99**

**D'ANGELICO – MASTER GUITAR BUILDER: WHAT'S IN A NAME?** – F. Green – Illustrated history. **\$29.95**

**DESKTOP REFERENCE OF HIP VINTAGE GUITAR AMPS** – Weber. **\$39.95**

**DREAM FACTORY** – Wheeler – 600 page in-depth look at the Fender Custom Shop. HC w/slipcase. **\$75.00**

**ELECTRIC GUITAR CONSTRUCTION** – Hirst – Definitive guide for the first time builder. **\$39.95**

**ELECTRIC GUITAR SOURCEBOOK** – Hunter – How to find the sounds you like. **\$24.95**

**ELECTRIC GUITARS AND BASSES** – Gruhn/Carter – Photographic history, revised & updated. **\$24.99**

**EPIPHONE GUITAR BOOK** – Carter – Complete history of Epiphone guitars. **\$24.99**

**FAQ: ACOUSTIC GUITAR CARE & SETUP** – Answers to frequently asked questions. **\$7.95**

**FAQ: BASS GUITAR CARE & SETUP** – Answers to frequently asked questions. **\$7.95**

**FAQ: ELECTRIC GUITAR CARE & SETUP** – Answers to frequently asked questions. **\$7.95**

**FAQ: TYPES & USES OF THE CAPO** – Choosing and using a capo. **\$3.95**

**FENDER AMPS – THE FIRST 50 YEARS** – Teagle/Sprung – First book to chronicle this company's amazing contribution to the amplifier, including its history and operation. **\$34.95H**

**FENDER BASS** – Black/Molinario – An illustrated history that chronicles the instrument from 1951-2001, providing background, history and facts. **\$24.95**

**FENDER BASS HANDBOOK** – Balmer – How to buy, maintain and modify your bass. Hard Cover. **\$25.00**

**FENDER – 60 YEARS OF** – Bacon – 6 decades of the greatest electric guitars. **\$24.99**

**The FENDER STRATOCASTER** – A.R. Duchossoir – All there is to know about the Stratocaster and its detailed evolution since 1954. **\$15.95**

**FENDER STRATOCASTER HANDBOOK** – Balmer – How to buy, maintain and modify your Strat. Hard cover. **\$24.95**

**FENDER TELECASTER** – A.R. Duchossoir – This book relates the story of Telecaster guitar since 1950. **\$16.95**

**FENDER TELECASTER** – Hunter – Life & times of the electric guitar that changed the world. HC. **\$40.00**

**FENDER TELECASTER – 6 DECADES OF** – T. Bacon – Story of the world's first solid body electric guitar. **\$22.95**

**FENDER TELECASTER HANDBOOK** – Balmer – How to buy, maintain and modify your Tele. Hard cover. **\$25.00**

**FENDER – THE SOUND HEARD 'ROUND THE WORLD** – R. Smith – History of the company and the guitars. Hard cover book/DVD **\$35.00**

**FLYING V/EXPLORER/FIREBIRD** – Bacon – History of Gibson's odd-shaped electric guitars. **\$24.99**

**FRETLESS BASS** – Bass Player magazin presents interviews, lessons and guides to this instrument. **\$19.95**

**FUNK GUITAR & BASS** – P. Madsen – Know the players, play the music. Hardcover spiral, with CD. **\$24.95**

## USUAL PRINT DEALER DISCOUNT ON THESE TECHNICAL AND INFORMATION FILLED BOOKS FOR THE MUSIC STORE AND MODERN MUSICIAN

**GEAR SECRETS OF THE GUITAR LEGENDS** – P. Prown/L. Sharkey – Presents historical insights, tone and technique analyses, gear lists, signal chain diagrams and the artists' own words for 36 top players. Includes CD. **\$19.95**

**GIBSON 335** – A. Ingram – It's history and it's players. **\$29.95**

**GIBSON ELECTRIC STEEL GUITARS 1935-1967** – Duchossoir – Comprehensive view of their "Hawaiian" guitars, with detailed dating information. Hardcover. **\$40.00**

**GIBSON FLYING V** – Fjestad/Meiners – Everything you need to know about this distinctive guitar. **\$19.95**

**GIBSON LES PAUL, 50 YEARS OF THE** – Bacon – Examines the guitars and the players. **\$22.95**

**GIBSON LES PAUL HANDBOOK** – Balmer – How to buy, maintain and modify your Les Paul. Hard cover. **\$25.00**

**GIBSON, THE OTHER BRANDS OF** – Fox – Complete guide to all the other brands Gibson produced from 1929-1961. **\$29.99**

**GRETSCH – The GUITARS OF THE FRED GRETSCH COMPANY** – J. Scott – This is the comprehensive must-own collector's manual for any Gretsch fan. **\$35.00**

**GRETSCH ELECTRICS, 50 YEARS OF** – T. Bacon – Half a century of White Falcons, Gents, Jets and other great guitars. **\$24.95**

**GRUHN'S GUIDE TO VINTAGE GUITARS** – Gruhm/Carter – An identification guide for American fretted instruments: acoustic and electric guitars, plus selected basses and mandolins. 3rd Ed. Hard cover. **\$32.99**

**GRUHN'S GUIDE TO VINTAGE GUITARS** – New pocket guide version of this standard identification guide. **\$24.99**

**GUITAR AFICIONADO: THE COLLECTIONS** – Large size volume depicting the most famous, rare and valuable guitars in the world as chosen by Guitar Aficionado magazine. HC. **\$50.00**

**GUITAR AMP HANDBOOK** – D. Hunter – Understanding tube amps and getting great sounds. **\$24.99**

**GUITAR BUILDING BASICS** – Pacheco/Remus – Learn acoustic assembly at home. **\$27.95**

**GUITAR CARE AND GEAR ESSENTIALS** – Instructions on maintaining your guitar and choosing gear. **\$9.99**

**GUITAR EFFECTS PEDALS** – D. Hunter – Practical handbook on vintage and contemporary pedals. **\$29.99**

**GUITAR ELECTRONICS FOR MUSICIANS** – Brosnac – A comprehensive guide for everyone interested in electric guitars. Step-by-step explanations with over 350 photos, drawings, and schematics. **\$24.99**

**GUITAR GEAR 411** – M. Bruck – Guitar tech to the stars answers your gear questions. **\$16.95**

**GUITAR GEAR OF THE GREATS** – Rubin – The guitars, amps and effects behind the sound of 100 players. Includes CD. **\$19.99**

**GUITAR HANDBOOK (Fully Revised)** – Denyer - A complete book of instruction and advice for every guitar player and every style - rock, blues, jazz or folk. **\$32.99**

**GUITAR IDENTIFICATION** – A. Duchossoir – Reference guide to serial numbers for dating the guitars of Fender, Gibson, Gretsch and Martin – 4<sup>th</sup> Ed. **\$12.95**

**GUITAR PICKUP HANDBOOK** – D. Hunter – An exhaustive and authoritative tonal guide to the most essential component for the sound of your guitar. Includes CD. **\$24.95**

**GUITAR PLAYER BOOK** – M. Molenda – 40 years of interviews, gear and lessons from the world's most celebrated guitar magazine. **\$24.95**

**GUITAR PLAYER REPAIR GUIDE** – Erlewine – How to set up, maintain, and repair electric and acoustic guitars. BK/DVD. **\$32.99**

**GUITAR QUESTIONS** – B. Lipman – Novice's guide to guitar repairs. **\$10.95**

**GUITAR RIGS** – D. Hunter – Study of classic guitar & amp combinations. **\$24.95**

**GUITAR SETUP & MAINTENANCE** – Johnston – Learn to properly adjust your guitar for peak playability and optimum sound. 6 x 9 size. **\$14.99**

**GUITAR SETUP, MAINTENANCE & REPAIR** – Levan – For musicians & technicians of all levels. **\$24.95**

**GUITAR TONE** – Gallagher – Pursuing the ultimate guitar sound. **\$34.99**

**GUITARIST'S GUIDE TO MAINTENANCE & REPAIR** – Redler/Rubin – How to maintain your axe like a pro. **\$14.99**

**GUITARIST'S GUIDE TO SET-UP AND MAINTENANCE** – C. Chandler – Ultimate user's guide. **\$9.95**

**HISTORY OF THE AMERICAN GUITAR** – Bacon – Dating from 1833 to today, with beautiful detailed photos. **\$27.99**

**HOFNER GUITAR – THE HISTORY** – Giltrap/Marten – Photos, details and history. Hardcover. **\$24.99**

**HOW TO BUILD ELECTRIC GUITARS** – Kelly – Complete guide to building and setting up your own custom guitar. **\$29.95**

**HOW TO HOT ROD YOUR FENDER AMP** – Falla – How to get magical tone. **\$27.99**

**HOW TO MAKE YOUR ELECTRIC GUITAR PLAY GREAT** – Erlewine – Get the most from your guitar. **\$19.95**

**HOW TO WRITE SONGS IN ALTERED GUITAR TUNINGS** – Rooksby – Unique manual of techniques for songwriters who compose on guitar. BK/CD. **\$22.99**

**HOW TO WRITE SONGS ON GUITAR** – R. Rooksby – A guitar-playing and songwriting course. **\$22.99**

**IBANEZ ELECTRIC GUITAR BOOK** – Bacon – A complete history of Ibanez electric guitars. **\$24.99**

**INTRODUCTION TO GUITAR TONE & EFFECTS** – D. Brewster – Learn to get the best sounds. Includes CD with audio examples. **\$12.95**

**INVENTING THE AMERICAN GUITAR** – Shaw & Szego – Covering pre-Civil War innovations of C.F. Martin and his contemporaries. HC. **\$50.00**

**JAZZ BASS BOOK** – J. Goldsby – Technique and tradition of the string bass, includes CD. **\$24.99**

**LAP STEEL GUITAR** – A. Volk – In depth study of acoustic & electric lap and console steel guitar. **\$35.00**

**LUTHIER'S HANDBOOK** – R. Siminoff – Guide to building great tone in acoustic stringed instruments. **\$22.95**

**MARTIN, C.F. & HIS GUITARS 1796-1873** – Gura – A look at the legendary figure and the times. **\$29.99**

**MARSHALL, THE HISTORY OF** – Doyle & Bowcott – The first fifty years of this classic amp manufacturer. **\$40.00**

**MARTIN BOOK, THE** – Carter – Complete history of Martin guitars. **\$24.95**

**MARTIN GUITARS: A HISTORY** – Johnston/Boak – covers the people, stories and instruments of this fabled company. HC. **\$30.00**

**MARTIN GUITARS: A TECHNICAL REFERENCE** – Johnson/Boak – Historical facts on the production runs and manufacturing specs of virtually every Martin instrument since 1833. Hardcover. **\$35.00**

**MARTIN GUITARS: THE BOXED SET** – Johnson/Boak – Special slipcased set of **A History** and **A Technical Reference** books. **\$70.00**

**MARTIN UKULELE, THE** – Walsh & King – The history and resurgence of the Martin Uke. **\$30.00**

**MODERN GUITAR RIGS** – Kahn – The tone fanatic's guide to integrating amps and effects. With DVD. **\$24.99**

**NEPTUNE BOUND** – D. Tulloch – Ultimate Danelectro guitar guide. **\$39.95**

**NEW COMPLETE GUITARIST** – Chapman – All visual approach to mastering the guitar. **\$21.95**

**NORMAN'S RARE GUITARS** – N. Harris – Over 30 years of buying, selling and collecting. **\$39.95**

**ON PRACTICING** – R. Iznola – Manual for students of guitar performance. **\$6.95**

**OFFICIAL VINTAGE GUITAR MAGAZINE PRICE GUIDE** – Greenwood 2014 edition – This authoritative and up-to-date guide offers 1000s of market values on 100s of brands and models of guitars, amps, basses, effects pedals and more. **\$29.95**

**LES PAUL GUITAR BOOK** – T. Bacon – Complete history of Gibson Les Paul guitars. **\$24.99**

**LES PAUL – LEGACY EARLY YEARS** – R. Lawrence – Covers 1915-1963. HC. **\$40.00**

**LES PAUL LEGACY – MODERN ERA** – R. Lawrence – Covers the years 1968-2009. HC. **\$40.00**

**LES PAUL LEGACY – COMPLETE** – Slipcased set of **Early Years** and **Modern Era**. **\$89.99**

**PEAVEY REVOLUTION, THE** – K. Achard – The man, the gear and the company. **\$29.95**

**PICKUPS** – Milan – Technical history of how the electric guitar evolved. **\$29.95**

## USUAL PRINT DEALER DISCOUNT ON THESE TECHNICAL AND INFORMATION FILLED BOOKS FOR THE MUSIC STORE AND MODERN MUSICIAN

**PRS GUITAR BOOK** – D. Burrluck – Complete history of Paul Reed Smith Guitars. **\$35.00**

**REGAL MUSICAL INSTRUMENTS 1895-1955** – Carlin – History of this instrument manufacturer. **\$45.00**

**RICKENBACKER** – Smith – Complete illustrated history of this company. **\$35.00**

**RICKENBACKER ELECTRIC BASS, THE** – Boyer – Includes hundreds of photos and descriptions detailing the history and players of this instrument. **\$24.99**

**RICKENBACKER ELECTRIC 12 STRING** – Bacon – Story of the guitars, the music and the players. **\$24.99**

**RIFFS** – R. Rooksby – How to create and play great guitar riffs. **\$19.95**

**ROUGH GUIDE TO GUITAR, THE** – Hunter – Covers buying, playing, gigging and recording. **\$22.99**

**SERIOUS GUITARIST, THE: ESSENTIAL BOOK OF GEAR** – Hurwitz – Comprehensive guide to guitars, amps, and effects for the dedicated guitarist. Bk/CD. **\$19.99**

**SET UP AND MAINTENANCE** – J. Carruthers – Player's guide to guitar care. **\$6.95**

**SETUP & MAINTENANCE** – Johnson – Learn to properly adjust your guitar for peak playability and optimum sound. Includes Korg solo tuner GA-1. **\$24.99** Book only **\$12.99**

**SIX-STRING HEROES** – Zlozower – 40 years of his photos of the most influential and dynamic guitarists. HC. **\$35.00**

**SOUL OF TONE** – T. Wheeler – Celebrating 60 years of Fender amps. Hardcover w/2 CD's. **\$60.00**

**SPANN'S GUIDE TO GIBSON 1902-1941** – Spann – Detailed look at the production and serial numbers during this period. **\$39.99**

**SQUIER ELECTRICS** – Bacon – 30 years of Fender's budget guitar brand. **\$24.99**

**STRATOCASTER CHRONICLES** – T. Wheeler – Celebrating 50 years of the Fender Strat. Hardcover with CD. **\$50.00**

**TEACH YOURSELF GUITAR REPAIR & MAINTENANCE** – J. Carruthers – Everything you need to know to start working on your guitar. Bk/DVD **\$29.95** Book only **\$9.95**

**TEACHING GUITAR** – J. Fisher – Guide to making a living as a professional guitar teacher. **\$17.95**

**TELECASTER GUITAR BOOK** – Bacon – Complete history of Fender Telecaster guitars. **\$24.95**

**STONE MANUAL** – Hunter – Discovering your ultimate electric guitar sound. With CD. **\$24.99**

**THE TUBE AMP BOOK** – A. Pittman – A reference guide for countless musicians to keep their amps in top playing condition. **Deluxe Edition** – Large size hard cover spiral w/CD. **\$49.95**

**TUBE AMP TALK FOR THE GUITARIST AND TECH** – Weber – Whether you want to maintain your amp to keep the tone you love, or modify it for an exciting new sound, it is in these pages. **\$37.95**

**TUBE GUITAR AMPLIFIER ESSENTIALS** – G. Weber – Basics, tips and troubleshooting. **\$34.95**

**UKULELE, THE** – J. Beloff – A fun, photo-filled look at the ongoing story of this diminutive instrument. HC. **\$24.95**

**UKULELE, THE – A VISUAL HISTORY** – Beloff – Filled with fun photos and history about this instrument. **\$24.95**

**ULTIMATE GUITAR TONE HANDBOOK** – Owsinski/Tozzoli – Creating and recording great guitar sounds. Bk/DVD. **\$39.99**

**WASHBURN PREWAR INSTRUMENT STYLES** – Guitars, mandolins, banjos and ukuleles 1883-1940. **\$45.00**

---

### GENERAL MUSIC/MISCELLANEOUS

---

**A CAPPELLA POP** – McDonald – Complete guide to contemporary a cappella singing. **\$19.99**

**ARRANGING & COMPOSING** – D. Baker – For the small ensemble: Jazz, R&B and Jazz-Rock. **\$29.95**

**BASIC GUIDE TO HOW TO READ MUSIC** – H. Cooper – Learning the simple principles for a beginner or as a refresher course. **\$9.99**

**BASIC RHYTHMIC TRAINING** – R. Starer – Exercises to understand elementary rhythmic notation. **\$8.95**

**BASTIEN – HOW TO TEACH PIANO SUCCESSFULLY** – In-depth guidelines for piano teachers. **\$29.95**

**BEST MUSICIAN'S JOKES** – Kassel/May – Over 400 jokes. **\$9.99**

**BRIDE'S GUIDE TO MUSICIANS** – Roos – Live wedding music made easy and affordable. **\$19.99**

**EFFORTLESS MASTERY** – K. Werner – Learn to liberate the master musician within. Bk/CD. **\$20.00**

**ELEMENTARY RUDIMENTS OF MUSIC** – B. Wharram – Spiral workbook, 2nd edition. **\$34.95**

**ESSENTIALS OF MUSIC NOTATION** – Gerou/Lusk – Every aspect of notation is covered. **\$11.95**

**ESSENTIALS OF ORCHESTRATION** – Black/Gerou – Practical resource for composers, arrangers & orchestrators. **\$11.95**

**EVERYDAY VOICE CARE** – Cazden – Lifestyle guide for singers and talkers. **\$19.99**

**GOD SONGS** – Baloch/Owens – How to write & select songs for worship. **\$19.50**

**GUIDE TO JAZZ COMPOSITION & ARRANGING** – J. Coker – All the info you need. **\$18.95**

**HELP! MY KID IS TAKING MUSIC LESSONS** – A. Glise – Handbook for the confused parents of young musicians. **\$9.95**

**HEY MOM! LISTEN TO THIS!** – Schmidt – Parent's guide to music and music education. **\$19.99**

**INDEPENDENT PIANO TEACHER'S STUDIO HANDBOOK** – Klingenstein – Everything you need to know for a successful teaching studio. **\$29.99**

**INNER GAME OF MUSIC** – Green/Gallwey – Learn to experience the joy of music to the fullest. HC. **\$25.95**

**INSTRUMENTAL JAZZ ARRANGING** – Tomaro/Wilson – Systematic presentation of the essential techniques and materials of jazz arranging. With 2 CD's. **\$49.99**

**JAZZ MUSICIAN'S GUIDE TO CREATIVE PRACTICING** – D. Berkman – Notes on the difficult, humorous, endless path of becoming a better improvising musician. Bk/CD. **\$29.00**

**JUMPSTART YOUR MUSIC CAREER** – Cann – Learn the difference between success and failure, and about having a strategy and executing it. **\$29.99**

**MAJORING IN MUSIC** – R. Holly – All the stuff you need to know. **\$14.99**

**MAKING YOUR MARK IN MUSIC** – Paris – Stage performance secrets and behind the scenes of artist development. With DVD. **\$29.99**

**MUSIC MAKES YOUR CHILD SMARTER** – Sheppard – How music helps your child's development. Bk/CD. **\$19.95**

**MUSICIAN'S GUIDE TO BRIDES** – A. Roos – How to make money playing weddings. **\$24.99**

**MUSICIAN'S ULTIMATE JOKE BOOK** – Over 500 one-liners, quips, jokes and tall tales. **\$9.95**

**MUSICIAN'S YOGA** – M. Olsen – Guide to practice, performance and inspiration. **\$14.99**

**NURTURED BY LOVE** – S. Suzuki – The classic approach to talent education. **\$13.95**

**PLAYING (LESS) HURT** – Horvath – An injury prevention guide for musicians. **\$29.99**

**PRACTICE PERSONALITIES: WHAT'S YOUR TYPE?** – Cline – Identifying and understanding the practice personality type in the music student. Bk/CD. **\$24.99**

**PRACTICING THE PIANO** – Breth – How students, parents, and teachers can make practicing more effective. **\$12.99**

**REALITY CHECK** – Pres/Landsman – Priceless advice for aspiring musicians. **\$24.95**

**RHYTHMIC TRAINING** – R. Starer – Continues the study from "Basic Rhythmic Training." **\$9.99**

**STORIES OF FAITH & INSPIRATION** – Johnston – The author shares her spiritual journey of piano teaching, by presenting 25 lessons she learned from her piano students and relating them to scripture. **\$9.99**

**TIME FLIES** – M. Uszler – How to make the best use of teaching time. **\$9.50**

**WOODSTOCK VISION** – E. Landy – Classic photos that helped define the Woodstock era. **\$35.00**

# MATHIAS THOMA



## VIOLIN

Assembled overseas in our affiliate shop. Amber brown nitro lacquer. Fully carved spruce top. Fully carved maple back & sides. Highly seasoned maple bridge. Ebony fittings. Wittner Style metal tailpiece. D'Addario Prelude Strings. Student rosin included. Available in sizes: 4/4, 3/4, 1/2, 1/4, 1/8.

**MTH30** ..... \$420.00



## VIOLIN

Assembled overseas in our affiliate Romanian shop. Hand rubbed antique varnish. Fully hand carved Carpathian spruce top. Fully hand carved Carpathian maple back & sides. Highly seasoned German maple bridge. Ebony fittings. Four Wittner String adjusters. D'Addario Zyex Strings. Student rosin included soft case. Available in sizes: 4/4, 3/4, 1/2, 1/4, 1/8.

**MTH55** ..... \$765.00



## VIOLIN

Assembled in our affiliate Prague shop. Hand rubbed reddish brown spirit varnish. Fully hand carved Carpathian spruce top. Fully hand carved Carpathian maple back & sides. Highly seasoned German maple bridge. Ebony fittings. Four Wittner String adjusters. Thomastik Dominant Strings. Oblong case. Wood Brazilwood bow. Available in sizes: 4/4.

**MTH100** ..... \$1,050.00



MTH70

## CELLO

Assembled overseas in our affiliate shop. Redish brown nitro lacquer finish. Euro-style laminated spruce top. Euro-style laminated maple back & sides. Highly seasoned maple bridge. Ebony fittings. Wittner Style metal tailpiece. D'Addario Prelude Strings. Student rosin included. Codura bag. Brazilwood bow. Available in sizes: 4/4, 3/4, 1/2, 1/4.

**MTH70** ..... \$1,245.00

## CELLO

Assembled overseas in our affiliate shop. Redish brown nitro lacquer finish. Fully carved spruce top. Euro-style laminated maple back & sides. Highly seasoned maple bridge. Ebony fittings. Wittner Ultra tailpiece. D'Addario Kaplan Strings. Student rosin included. Codura bag. Brazilwood Bow. Available in sizes: 4/4, 3/4, 1/2, 1/4.

**MTH75** ..... \$1,500.00



MTH75

## CELLO

Assembled overseas in our affiliate shop. Redish brown nitro lacquer finish. Fully carved spruce top. Fully carved flamed maple back & sides. Highly seasoned maple bridge. Ebony fittings. Wittner Ultra tailpiece. D'Addario Kaplan Strings. Student Rosin included. Foam core cello case with wheels. Brazilwood bow. Available in sizes: 4/4, 3/4, 1/2, 1/4.

**MTH65** ..... \$2,500.00

## CELLO

Assembled in our affiliate Prague shop. Hand rubbed old world brown spirit varnish. Carved seasoned Carpathian spruce top. Carved flamed Italian poplar back & sides. Highly seasoned European maple bridge. Ebony fittings. Wittner A and D-string adjuster. D'Addario Kaplans. Foam core cello case with wheels. Brazilwood bow. Available in sizes: 4/4.

**MTH95** ..... \$4,500.00



MTH80

## BASS

Assembled overseas in our affiliate shop. Redish brown nitro lacquer finish. Euro-style laminated spruce top. Euro-style laminated maple back & sides. Ebony fittings. Kolstein adjustable bridge. D'Addario Prelude strings. Student rosin included. Codura bag. French Brazilwood bow. Available in sizes: 3/4, 1/2, 1/4.

**MTH80** ..... \$2,625.00

## BASS

Assembled overseas in our affiliate shop. Redish brown nitro lacquer finish. Fully carved spruce top. Euro-style laminated maple back & sides. Kolstein adjustable bridge. Ebony fittings. D'Addario Kaplan strings. Student rosin included. Codura bag. French Brazilwood bow. Available in sizes: 3/4, 1/2, 1/4.

**MTH99** ..... \$3,300.00



MTH202

## BASS

Assembled overseas in our affiliate shop. Redish brown nitro lacquer finish. Fully carved spruce top. Fully carved flamed maple back & sides. Kolstein adjustable bridge. Ebony fittings. D'Addario Kaplan strings. Student rosin included. Codura bag. French Brazilwood bow. Available in sizes: 3/4.

**MTH68** ..... \$7,500.00

## BASS

Assembled in our affiliate Prague workshop. Special edition antiqued varnish. Seasoned European spruce top. Seasoned European poplar back & sides. Moderately figured maple neck & scroll. Ebony fittings. A Kolstein adjustable tailpiece. A Kolstein adjustable bridge. Kolstein Heritage strings. Available in sizes: 3/4. **Bass only.**

**MTH202** ..... \$10,200.00

NOTE: Mathias Thoma Drop Ship from East Coast



# BOWED INSTRUMENTS



## ANTONIUS

Hand Carved Solid Spruce Top Carved Solid Maple Back & Sides  
Hand Carved Solid Maple Neck  
Golden Brown Finish  
Hardshell Case with Tolex Cover  
Mongolian Horsehair Bow  
Available in Sizes 4/4, 3/4, 1/2

**VN150** .....\$138.55



## PALATINO

A solid carved spruce top and maple back. Dyed hardwood pegs and fingerboard. Feather weight case. Wood bow, horsehair. Available in: 4/4, 3/4, 1/2, 1/4, 1/8, 1/16 sizes.

**VN350** .....\$137.75

## PALATINO

Hand carved solid spruce top. Hand carved solid maple back, sides, and neck. Inlaid purfling. Anodized fine tuner tailpiece. Golden brown finish. Ebony frog bow with Mongolian horsehair bow. Featherweight case with nylon cover.

**VN450** .....\$171.60



## PALATINO

- Tight Grained, Select Spruce Top
- Highly Flamed Maple Back & Sides
- Exquisite Oil Varnish Finish
- Ebony Fittings
- Anodized Fine Tuner Tailpiece
- Brazilwood Bow with Ebony Frog
- Dexuxe Violin Rosin
- Featherweight Suspension Case
- Sizes 4/4

**VN850** .....\$432.75

## BECKER VIOLIN/VIOLA



## BECKER VIOLIN

Hand-crafted in Romania, these attractive red-brown satin finish instruments feature graduated solid spruce top, solid maple back and sides, solid maple neck and scroll, inlaid purfling, ebony pegs, nut, fingerboard and tailpiece. Available in 4/4 - 1/8 size.

**B175** Violin .....\$359.05

**B175A** Violin Outfit .....485.00

## BECKER VIOLA

Nicely flamed reddish brown viola with 4 string adjusters. Available in 16" - 12"

**B275** Viola .....\$401.00

**B275A** Viola Outfit .....549.00



## PALATINO VIOLA OUTFITS

Outfit includes viola, wood bow, hardshell case.

**VA350** 15", 16" .....\$199.80

**VA450** 13", 14", 15", 16" .....216.30

**VA850** 16" .....517.10

## ANTON BRETON VIOLIN OUTFITS



Handcarved, properly graduated, solid spruced top. Handcarved solid maple back, sides and neck. Fine gloss finish. Better quality woods and workmanship. Delicately inlaid purfling. Polished ebony fingerboard and fittings. VP-61 black-anodized, aluminum alloy, fine-tuner tailpiece. Golden brown finish. VP-72 wood bow, better quality, with genuine unbleached white horsehair. C-3907 Featherweight® case, blue exterior and light grey interior. Available in 4/4 - 1/8 size.

**AB20** .....\$209.90

Inlaid purfling. Ebonized hardwood fingerboard and fittings. AB-100 wood stick bow, rosewood frog, unbleached white horsehair. Archtop shaped case w/black exterior and green interior. Available in 4/4 - 1/8 size.

**AB05** .....\$146.95



## PALATINO CELLO OUTFIT

Solid spruce top maple sides, back and neck, 4 string adjusters. Nylon padded bag. Wood, horsehair bow. 4/4, 3/4, 1/2, 1/4, 1/8 sizes.

**VC450** .....\$837.75

**VC850** 4/4 .....1278.70

## ANTONIUS CELLO OUTFIT

Spruce top, maple back, sides and neck. Golden brown finish. Cordura nylon bag. Horsehair. 4/4, 3/4 sizes.

**VC150** .....\$491.05



## PALATINO BASS OUTFITS

Laminated spruce top maple back, sides and neck. Nylon padded bag. Wood horsehair bow. 3/4, 1/2, sizes.

**VB004** .....\$1296.50

**VB029** 3/4 with bag .....1950.80

Solid Hand Carved Spruce Top, Flamed Maple Back and Sides, Adjustable Rock Maple Bridge, Ebony Fingerboard.

**34VB012NA** Natural Blonde .....\$1367.10

BASSES SHIP VIA FREIGHT



## ELECTRIC BASS

Solid spruce top, maple back & sides, ebony fingerboard, Piezo transducer pickup, active tone & volume, controls, headphone jack, maple bridge, sunburst finish, combination leather/plastic, bag with backpack straps.

**VE500** .....\$1374.50

**VE500BK** Black .....1374.50

**PV517** Violin Bridge for VE500 .....76.45

# ENGELHARDT

## MAESTRO BASS

A popular school model that has won wide acceptance by students and advanced players. Properly sized and aligned, it has a close grained spruce top, curly maple back. Beautiful brown finish. Attractive violin shape with rosewood trimmings. This is a durable, yet responsive instrument.

**EM1** Maestro Bass,  
Standard (3/4) Size.....**\$2,325.00**

## MAESTRO JUNIOR BASS

The perfect bass for the intermediate student. It has a close grained spruce top and maple back. Violin shaped, with a brown finish. Hard maple fingerboard.

**EM3** Maestro Bass, Junior (1/4) Size ..**\$2,100.00**

## CONCERT MODEL BASS

The perfect bass for the school student. Spruce top and curly maple back. Maple neck, fingerboard and tailpiece. Extremely durable – yet has unusual carrying power. The handsome finish is a beautiful mahogany color.

**EC1** Concert Model Bass,  
Standard (3/4) Size .....**\$2,325.00**

## SUPREME MODEL BASS

Used by professional players everywhere. This bass possesses a remarkably rich and vibrant tone through the entire range. Beautiful Cremona brown finish. Top of close grained spruce, back of curly maple. Deluxe ebony fittings. Violin shaped. Superbly crafted.

**ES1** Supreme Model Bass,  
Standard (3/4) .....**\$3,300.00**

## SWINGMASTER MODEL BASS

Here is the top professional bass in a beautiful, natural blonde finish. Same quality construction as used in the "Supreme" model (listed above). Startling to look at. Talked about wherever seen.

**ES9**.....**\$3,525.35**

ALL BASSES SHIP VIA FREIGHT



## CONCERT MODEL CELLO

A deluxe ebony trimmed model with professional features. Select spruce top and curly maple back. Beautiful rich brown finish.

**E120** Concert model Cello,  
Standard (4/4) Size .....**\$1,455.00**

## SCHOOL MODEL CELLO

Our most popular school instrument. Available in three sizes. Close grained spruce top, curly maple back, it has a rich brown finish with rosewood fittings. A beautiful instrument with fine tone and durability.

**E110** School Model Cello,  
Standard (4/4) Size .....**\$1,140.00**

**E111** School model Cello,  
Intermediate (3/4) Size .....**1,140.00**

# BOWS



AB110



2000X



12VLN



34BSS

## VIOLIN

<b>AB110</b>	Brazilwood w/horsehair round, 4/4 only, bow colored only	<b>\$20.95</b>
	(BK) Black, (BU) Burgundy, (GN) Green, (PP) Purple, (RS) Rose	
<b>AB110</b>	Wood Bow w/horsehair, available in all sizes	<b>20.95</b>
<b>AB100</b>	Wood Bow w/horsehair, available in all sizes	<b>14.65</b>
<b>AB112</b>	Brazilwood w/horsehair round, ebony frog, avail. in all sizes	<b>27.25</b>
<b>AB113</b>	Brazilwood w/horsehair octagon, 4/4-1/4 sizes	<b>31.45</b>
<b>AB114</b>	Brazilwood w/horsehair round, 4/4-1/4 sizes	<b>41.95</b>
<b>AB115</b>	Brazilwood w/horsehair octagon, 4/4-1/4 sizes	<b>47.20</b>
<b>AB116</b>	Brazilwood w/horsehair round, 4/4 only	<b>52.45</b>
<b>AB116F</b>	Fiberglass 4/4-1/4 sizes	<b>57.70</b>
<b>AB119</b>	Brazilwood w/horsehair octagon, 4/4 only	<b>73.45</b>
<b>AB120</b>	Carbon Fiber round, 4/4 only	<b>89.20</b>
<b>BV700</b>	Wood Bow w/horsehair, available in all sizes	<b>25.50</b>
<b>BV760</b>	Wood Bow w/horsehair, available in all sizes	<b>35.55</b>
<b>H201</b>	Glasser Fiberglass, w/horsehair, in all sizes 1/2 lined frog	<b>63.00</b>
<b>SH203</b>	Glasser Fiberglass w/horsehair, all sizes	<b>82.50</b>
<b>2000X</b>	Glasser, Graphite, 1/2 lined frog	<b>148.50</b>
<b>200AC</b>	Glasser Composite, full size	<b>158.40</b>
<b>2000CG</b>	Glasser, carbon graphite, all sizes	<b>297.00</b>
<b>9242</b>	Wood Bow w/Horsehair, all sizes	<b>64.99</b>
<b>BV885</b>	Pernambuco, octagonal, Horsehair 4/4 size	<b>168.95</b>
<b>B85</b>	Wood Bow, Octagon, Brazilwood	<b>86.25</b>
<b>IBCBR</b>	Bow Carrying Bag, Brown	<b>84.00B</b>

## VIOLA

<b>H301</b>	Glasser fiberglass, 1/2 lined frog	<b>\$69.00</b>
<b>SH303</b>	Glasser fiberglass w/horsehair	<b>88.50</b>
<b>3000X</b>	Glasser, Graphite, Full Size, 1/2 lined frog	<b>181.50</b>
<b>300AC</b>	Glasser Composite	<b>198.00</b>
<b>44AB110V</b>	Wood, full size Rosewood frog	<b>23.10</b>
<b>AB112V</b>	Brazilwood w/horsehair, ebony frog, full size	<b>28.30</b>

## CELLO

<b>B80C</b>	Full Lined Ebony Frog, Round Brazilwood	<b>\$92.35</b>
<b>AB110C</b>	Wood, 4/4, 3/4, 1/2	<b>28.30</b>
<b>AB112C</b>	Brazilwood w/horsehair, ebony frog, 4/4-1/4 sizes	<b>36.70</b>
<b>H401</b>	Glasser fiberglass w/horsehair	<b>108.00</b>
<b>SH403</b>	Glasser fiberglass w/horsehair	<b>127.50</b>
<b>4000X</b>	Glasser, Graphite, Full Size, 1/2 Lined Frog	<b>247.00</b>
<b>400AC</b>	Glasser Composite	<b>240.00</b>
<b>BV760C</b>	1/2 lined ebony frog, round	<b>50.80</b>
<b>BV780C</b>	Wood Bow octagonal Brazilwood, 1/2 lined frog	<b>52.10</b>

## BASS

<b>HG501</b>	Glasser fiberglass w/horsehair (German)	<b>\$144.00</b>
<b>HF501</b>	Glasser fiberglass w/horsehair(French)	<b>144.00</b>
<b>500ACF</b>	Glasser Composite (French)	<b>363.00</b>
<b>500ACG</b>	Glasser Composite (German)	<b>363.00</b>
<b>5000CGFR34</b>	Glasser, carbon graphite, full size (French)	<b>594.00</b>
<b>5000CGGR34</b>	Glasser, carbon graphite, full size (German)	<b>594.00</b>
<b>BV780BF</b>	Brazilwood, Octagonal (French) 1/2 lined	<b>173.00</b>
<b>BV780BG</b>	Brazilwood, Octagonal (German) 1/2 lined	<b>196.15</b>

## P&H FIBERGLASS BOWS YOU CAN REPAIR YOURSELF

BOWS		REPLACEMENT HAIR	
<b>12VLN</b>	1/2 Violin..... <b>\$59.70</b>	<b>12VLNBH</b>	1/2 Violin..... <b>\$12.00</b>
<b>34VLN</b>	3/4 Violin..... <b>59.70</b>	<b>34VLNBH</b>	3/4 Violin..... <b>12.00</b>
<b>44VLN</b>	4/4 Violin..... <b>59.70</b>	<b>44VLNBH</b>	4/4 Violin..... <b>12.00</b>
<b>34VLA</b>	3/4 Viola..... <b>73.85</b>	<b>34VLABH</b>	3/4 Viola..... <b>13.10</b>
<b>44VLA</b>	4/4 Viola..... <b>73.85</b>	<b>44VLABH</b>	4/4 Viola..... <b>13.10</b>
<b>34CLO</b>	3/4 Cello..... <b>86.45</b>	<b>34CLOBH</b>	3/4 Cello..... <b>13.10</b>
<b>44CLO</b>	4/4 Cello..... <b>86.45</b>	<b>44CLOBH</b>	4/4 Cello..... <b>13.10</b>
<b>34BSS</b>	3/4 Bass French..... <b>114.80</b>	<b>34BSSBH</b>	3/4 Bass..... <b>13.40</b>

## P&H CARBON FIBER BOWS

<b>CFVLN</b>	Violin Carbon Fiber 4/4, 3/4, 1/2.....	<b>\$155.90</b>
--------------	--	-----------------

## CELLO BAGS



### PADDED NYLON

<b>12KCB</b>	1/2, heavy duty, Ace.....	<b>\$153.80</b>
<b>34KCB</b>	3/4, heavy duty, Ace.....	<b>174.05</b>
<b>44KCB</b>	4/4, heavy duty, Ace.....	<b>190.20</b>
<b>B4744</b>	4/4, zipper, TKL.....	<b>113.45</b>
<b>B4734</b>	3/4, zipper, TKL.....	<b>104.85</b>
<b>B4712</b>	1/2, zipper, TKL.....	<b>94.45</b>
<b>C3918</b>	4/4, zipper, Saga.....	<b>83.95</b>
<b>34C3918</b>	3/4, zipper, Saga.....	<b>83.95</b>
<b>12C3918</b>	1/2, zipper, Saga.....	<b>83.95</b>
<b>14C3918</b>	1/4, zipper, Saga.....	<b>82.95</b>



### BLACK NYLON

<b>B4644</b>	4/4, zipper, TKL.....	<b>\$71.75</b>
<b>B4634</b>	3/4, zipper, TKL.....	<b>68.00</b>
<b>B4612</b>	1/2, zipper, TKL.....	<b>64.20</b>
<b>B4614</b>	1/4, zipper, TKL.....	<b>60.35</b>
<b>CV100C</b>	4/4, 3/4, 1/2 size.....	<b>61.00</b>
<b>44UKCB</b>	4/4 Zipper, Ace.....	<b>89.30</b>
<b>34UKCB</b>	3/4 Zipper, Ace.....	<b>81.80</b>
<b>12UKCB</b>	1/2 Zipper, Ace.....	<b>74.30</b>

## CASES

FREISTAT violin. Aluminum valance. Available in 4/4 - 1/8 sizes.

<b>FR450</b>	TKL.....	<b>\$98.20</b>
--------------	----------	----------------



FR450

Modular violin case.

<b>985V</b>	4/4 size.....	<b>\$109.05</b>
<b>986V</b>	3/4 size.....	<b>107.80</b>
<b>987V</b>	1/2 size.....	<b>106.95</b>
<b>988V</b>	1/4 size.....	<b>115.85</b>
<b>989V</b>	1/8 size.....	<b>121.10</b>

Shaped Featherweight, Palatino

<b>CV013</b>	4/4 - 1/16 Size.....	<b>\$78.35</b>
--------------	----------------------	----------------



CV015

Shaped Featherweight, Palatino

<b>CV015</b>	4/4, 3/4, 1/2, 1/4.....	<b>\$62.25</b>
--------------	-------------------------	----------------

Shaped Featherweight

<b>KBFVL14</b>	1/4 Size Polyfoam.....	<b>\$86.96</b>
<b>KBFVL12</b>	1/2 Size Polyfoam.....	<b>100.20</b>
<b>KBFVL34</b>	3/4 Size Polyfoam.....	<b>110.90</b>
<b>KBFVL44</b>	Full Size Polyfoam.....	<b>125.50</b>
<b>C3907</b>	4/4, 3/4 Size.....	<b>39.95</b>



KBFVL12

Oblong Hardshell Wood, TKL

<b>GC8388</b>	Double Violin-Arch Top.....	<b>\$341.05</b>
---------------	-----------------------------	-----------------

Oblong Hardshell, Palatino

<b>CV019</b>	Full size.....	<b>\$113.40</b>
--------------	----------------	-----------------

Black nylon cover, oblong

<b>44CV030</b>	Full Size.....	<b>\$156.85</b>
----------------	----------------	-----------------



CV019

Black nylon covered, full size, shaped violin.

<b>CV032</b>	Double Violin.....	<b>\$234.65</b>
<b>CV032M</b>	Violin/Mandolin.....	<b>239.05</b>

### VIOLA

Freistat molded plastic, shaped.

<b>992V</b>	16" to 16.5".....	<b>\$149.45</b>
<b>993V</b>	15" to 15.5".....	<b>149.45</b>



992V

### VIOLA

TKL - Zero gravity, shaped.

<b>TKL67015</b>	15" to 15.5".....	<b>\$83.15</b>
-----------------	-------------------	----------------

### VIOLIN CASE STRAPS

<b>MICS</b>	with Pad.....	<b>\$8.25</b>
<b>VCSBK</b>	Black.....	<b>6.60</b>
<b>CCS</b>	Blue Note.....	<b>9.95</b>
<b>CSL BK</b>	Black, Long, Neotech.....	<b>29.95</b>

## BASS BAGS



### PADDED NYLON

<b>34KUB</b>	3/4, heavy duty, Ace.....	<b>\$284.40</b>
<b>34C3910</b>	3/4 size, Saga.....	<b>169.95</b>
<b>B4834</b>	3/4 size, TKL.....	<b>264.85</b>
<b>B4647</b>	3/4 size, TKL.....	<b>109.60</b>
<b>B4646</b>	1/2 size, TKL.....	<b>86.90</b>
<b>B4645</b>	1/4 Size, TKL.....	<b>83.15</b>
<b>34UKUB</b>	3/4, Ace.....	<b>133.60</b>
<b>12UKUB</b>	1/2, Ace.....	<b>121.45</b>
<b>14UKUB</b>	1/4, Ace.....	<b>112.50</b>

## END PINS



<b>5885</b>	Pearwood, adj. rod, cello.....	<b>\$29.80</b>
<b>5886</b>	Ebony plug, adj. rod, cello.....	<b>49.25</b>
<b>GL3774H</b>	Hardwood, cello, glaesel.....	<b>37.00</b>
<b>GL3776H</b>	Hardwood, bass, glaesel.....	<b>39.00</b>
<b>GL3774E</b>	Ebony, cello, glaesel.....	<b>70.00</b>
<b>GL3776E</b>	Ebony, bass, glaesel.....	<b>85.00</b>
<b>EBEP</b>	Bass, rod with tip.....	<b>27.00</b>
<b>ECEP</b>	Cello, rod with tip.....	<b>27.00</b>
<b>50360</b>	Rubber endpin tips.....	<b>.70</b>
<b>WR6</b>	Wolf Super End pin, cello/bass (ball only).....	<b>37.99</b>
<b>ECEPT</b>	Cello End Pin Tip.....	<b>.90</b>
<b>EBEPT</b>	Bass End Pin Tip.....	<b>1.60</b>

## ENDPIN HOLDERS



RSC



XCA

<b>XCA</b>	Cello, Xeros.....	<b>\$25.00</b>
<b>XBA</b>	Bass, Xeros.....	<b>25.00</b>
<b>RSB</b>	Bass Rockstop.....	<b>14.00</b>
<b>RSC</b>	Cello Rockstop.....	<b>12.00</b>
<b>MSS</b>	Cello, Slip Stop, various colors.....	<b>9.15</b>
<b>SS9452</b>	Super Sensitive Stoppin.....	<b>10.10</b>
<b>SS9454</b>	Super Sensitive Stoppin, Large.....	<b>17.55</b>
<b>4084</b>	Cello, Trophy.....	<b>8.95</b>
<b>4085</b>	Bass, Trophy.....	<b>8.95</b>
<b>4090</b>	Bass/Cello, Trophy.....	<b>13.00</b>

## CASES



<b>SKB</b>		
<b>SKB444</b>	4/4 Violin, Deluxe.....	<b>\$171.99</b>
<b>SKB434</b>	3/4 Violin, Deluxe.....	<b>150.99</b>
<b>SKB244</b>	4/4 Violin (14" Viola).....	<b>129.99</b>
<b>SKB234</b>	3/4 Violin (13" Viola).....	<b>129.99</b>
<b>SKB212</b>	1/2 Violin (12" Viola).....	<b>129.19</b>
<b>SKB214</b>	1/4 Violin.....	<b>129.99</b>
<b>SKB264</b>	15"/16" Viola.....	<b>139.99</b>
<b>SKB344</b>	4/4 Cello.....	<b>373.99</b>
<b>SKBSC344</b>	4/4 Cello Soft Case.....	<b>274.99</b>
<b>SKB544</b>	4/4 Cello, Shell, w/ wheels.....	<b>544.99</b>

Shaped Featherweight

<b>44CV013C</b>	Full Size.....	<b>\$218.30</b>
-----------------	----------------	-----------------

## PITCH PIPES



SS9240	Violin Metal.....	\$11.15
SS9242	Cello Metal.....	11.15
PV013	Violin .....	4.05
KAYVP4	Violin .....	4.70
9340	Violin .....	10.50
KRATTSN3	Violin .....	20.55
2S3	Violin .....	13.95
KRATTSN6	Cello .....	20.55
CP4	Cello.....	4.70
PV013C	Cello.....	4.05

## POLISH



SS9220	Sup. Sen. 2 oz .....	\$9.99
SS9221	Sup. Sen. 1 oz.....	7.25
SS9224	Sup. Sens, 8 oz .....	16.95
GL39851	Glaesel, 2 oz .....	7.00
GL39853	Glaesel, 16 oz .....	35.00
MIC7323	Nushine .....	6.80
BL333	Blitz, 2 cloths .....	6.50
HC13	Howard Core .....	5.80
6592	Dunlop .....	4.95
5953	Rosin Remover .....	12.00

## BOW GUIDE



Encourages Proper Bow Placement  
SS9453 .....\$38.60

## VIOMETER



Measures student for correct violin size. Ideal for rental programs and group instruction.

VIOMETER .....\$32.99

## PEG DOPE/DROPS



PD12	1/2 oz. bottle, liquid Peg Dope.....	\$13.99
PD85	Hill Peg Dope.....	17.30
HC05	Core, Peg Dope.....	8.45

## BOWMASTER



A teaching aid to assist beginners in holding their violin bow correctly.

SS9480	Large .....	\$11.80
SS9482	Medium .....	11.80
SS9484	Small .....	11.80

## CARE KITS



SS9330	Violin Kit .....	\$43.85
SS9333	Cello Kit .....	41.35
GL3982	Glaesel .....	39.00

## CLOTH



Super Sensitive Polishing Cloth.

SS9447	.....	\$4.60
SS9448	w/polish.....	18.50
SS9449	w/1oz. polish.....	16.95

## GEL GLUE



Can of Ground Hide Gel Glue, 1 lb.  
SM669 .....\$44.45

## BOW HAIR

### GENUINE HORSE HAIR

BH31V	Violin, hank .....	\$9.45
XLBH	Violin, extra long, hank .....	11.90
BH51C	Cello, hank .....	10.35
BH61B	Bass, hank .....	10.05

### SYNTHETIC FIBER

HE902	Violin, coiled.....	\$4.00
MBH	Violin, Maatzaare.....	8.25



## BOW QUIVERS

1QBBK	Black Leather.....	\$58.90
PV250B	Black Leather.....	22.55

## STANDS



SA20



DS571BB



KM141BK



SA22



DS590B



DS580B

SA20	Violin/Viola, ShoAll.....	\$40.20
6200	Violin/Viola.....	25.20
DS571BB	Violin/Viola.....	64.99
KM15520	Violin, Black .....	47.99

KM141BK	Bass.....	\$149.99
KM1411B	Cello .....	149.99
HH08BK	Upright Bass Neck Support.....	18.00

SA22	Bass/Cello .....	\$88.20
DS580B	Cello Auto Grab.....	102.00
DS580X	Cello Home Series.....	131.99
DS590B	Bass.....	107.99

## STRING ADJUSTERS



<b>W905</b>	Full size Violin.....	<b>\$3.00</b>
<b>W903</b>	3/4, 1/2 size Violin.....	<b>3.30</b>
<b>W911</b>	Viola Adjuster.....	<b>4.40</b>
<b>BK911</b>	Black Version, W911.....	<b>4.45</b>
<b>W912</b>	Cello Adjuster.....	<b>14.40</b>
<b>BK913</b>	Black Version, W912.....	<b>14.55</b>
<b>W914</b>	1/2, 1/4 Cello Adjuster.....	<b>15.25</b>
<b>W901</b>	Suzuki type.....	<b>2.60</b>
<b>W906</b>	English Style.....	<b>6.00</b>
<b>W902</b>	Full size Violin.....	<b>3.35</b>
<b>BK902</b>	Black Version, W902.....	<b>3.60</b>
<b>BK904</b>	Black Version, W904.....	<b>5.40</b>
<b>W907</b>	3/4, 1/2 Violin, gut strings.....	<b>4.15</b>
<b>W904</b>	Full Size Violin, gut strings.....	<b>4.25</b>
<b>VP14</b>	4/4, 3/4 Violin.....	<b>1.70</b>
<b>VP14S</b>	1/2, 1/4 Violin.....	<b>1.65</b>
<b>VP131</b>	1/8, 1/16 violin.....	<b>1.65</b>
<b>VP14V</b>	Viola.....	<b>2.05</b>
<b>VP14CP</b>	4/4, 3/4 Cello.....	<b>4.75</b>
<b>VP14PCS</b>	1/2, 1/4 Cello.....	<b>4.75</b>
<b>PV020</b>	4/4, 3/4 Violin.....	<b>1.25</b>
<b>PV020S</b>	1/2, 1/4 Violin.....	<b>1.15</b>

## VIOLIN CHINRESTS



### WITNER

Antiallergic, anatomically designed, made of "Space Age" composite material. With a screwdriver included.

<b>W250111</b>	Full size.....	<b>\$38.65</b>
<b>W250121</b>	3/4 size.....	<b>38.65</b>

<b>2139</b>	Ebonized, fits over tailpiece.....	<b>\$14.25</b>
<b>2139A</b>	Ebonized, 1/2 and 1/4 size.....	<b>14.25</b>

### GUARNERI STYLE

<b>2134</b>	Ebony, fits over tailpiece.....	<b>\$26.25</b>
<b>2135</b>	Rosewood, over tailpiece.....	<b>24.90</b>
<b>CC1501</b>	Ebony.....	<b>22.40</b>
<b>CC1601</b>	Rosewood.....	<b>22.40</b>

### DRESDEN

<b>2141</b>	4/4, 3/4 size.....	<b>\$13.20</b>
<b>2141A</b>	1/2 size.....	<b>12.50</b>
<b>2136</b>	Dresden, Ebony.....	<b>24.90</b>
<b>2137</b>	Dresden, Rosewood.....	<b>24.95</b>
<b>14CR</b>	1/4, 1/8 size.....	<b>24.30</b>
<b>HC09</b>	Violin, Ribbed.....	<b>7.90</b>
<b>CC1522</b>	Ebony.....	<b>22.40</b>
<b>CC1610</b>	Rosewood.....	<b>22.40</b>
<b>5652</b>	Viola.....	<b>13.20</b>

### GLAESEL

<b>GL35921</b>	Matte, Low.....	<b>\$32.00</b>
<b>GL35922</b>	Matte, Medium Low.....	<b>32.00</b>
<b>GL3592E1</b>	Ebony, Low.....	<b>43.00</b>
<b>GL3592E2</b>	Ebony, Medium Low.....	<b>43.00</b>
<b>GL35124</b>	Dresden 3/4, 4/4.....	<b>15.00</b>
<b>GL35122</b>	Dresden 1/4, 1/2.....	<b>15.00</b>
<b>GL3512SE</b>	Dresden 1/16, 1/8.....	<b>15.00</b>
<b>GL3522</b>	Ribbed.....	<b>15.00</b>
<b>GL35324</b>	Over Tail Piece 3/4, 4/4.....	<b>14.00</b>
<b>GL35322</b>	Over Tail Piece 1/2.....	<b>14.00</b>
<b>GL35941</b>	Matte, Viola Low.....	<b>33.00</b>
<b>GL35942</b>	Matte, Viola Medium Low.....	<b>33.00</b>
<b>GL35943</b>	Matte, Viola Medium High.....	<b>33.00</b>
<b>GL3594E1</b>	Ebony, Viola Low.....	<b>43.00</b>
<b>GL3594E2</b>	Ebony, Viola Medium Low.....	<b>43.00</b>
<b>GL3534</b>	Over Tail Piece, Viola.....	<b>40.00</b>
<b>GL35346</b>	Over Tail Piece, Viola Junior.....	<b>16.00</b>
<b>GL3599</b>	Chin Rest Key.....	<b>7.00</b>

## MUTES

### SLIDING MUTE

<b>51115</b>	Violin.....	<b>\$8.25</b>
<b>51215</b>	Viola.....	<b>9.75</b>
<b>51315</b>	Cello.....	<b>14.25</b>
<b>TR3M</b>	Violin.....	<b>3.55</b>
<b>TR4M</b>	Viola.....	<b>4.50</b>
<b>TR5M</b>	Cello.....	<b>6.55</b>
<b>TR6M</b>	Bass.....	<b>15.00</b>



### SPECTOR

<b>SS9491</b>	.....	<b>\$8.95</b>
---------------	-------	---------------

### SAGA

<b>SVP50</b>	Metal Model.....	<b>\$15.75</b>
--------------	------------------	----------------



### TOURTE MODEL

<b>515</b>	Violin, round.....	<b>\$1.65</b>
<b>516</b>	Cello, round.....	<b>3.75</b>
<b>517</b>	Bass, round.....	<b>7.50</b>
<b>1305</b>	Violin, oval.....	<b>2.40</b>
<b>5150</b>	Violin, oval.....	<b>1.50</b>
<b>1228</b>	Bass, round.....	<b>11.90</b>



### EBONY MODELS

Best quality ebony mute.

<b>1120</b>	Violin.....	<b>\$6.95</b>
<b>GL3812</b>	Glaesel, Violin.....	<b>6.46</b>
<b>CC2051</b>	Violin.....	<b>3.15</b>
<b>CC2071</b>	Viola.....	<b>3.95</b>
<b>CC2371</b>	Cello.....	<b>7.90</b>
<b>CC2271</b>	Bass.....	<b>13.25</b>
<b>1154</b>	Viola.....	<b>8.35</b>
<b>1155</b>	Cello.....	<b>20.35</b>



### ULTRA PRACTICE MUTES

Lightweight rubber sound deadening mutes.

<b>4451116</b>	4/4 Violin.....	<b>\$4.05</b>
<b>3251116</b>	3/4, 1/2 Violin.....	<b>4.05</b>
<b>51216</b>	Viola.....	<b>6.00</b>
<b>51316</b>	Cello.....	<b>7.20</b>
<b>51416</b>	Bass.....	<b>12.00</b>



## CHIN COMFORTERS

Self Adhesive comfort cushion for chin rests.

<b>CHINSS</b>	Suzuki style.....	<b>\$4.50</b>
<b>CHINOT</b>	Over tailpiece style.....	<b>6.00</b>
<b>CHINPC</b>	Plastic Style.....	<b>4.80</b>

## SHOULDER RESTS



### SUPER SENSITIVE

<b>SS9460</b>	Thin, shoulder rest.....	<b>\$15.05</b>
<b>SS9461</b>	Thick blk, shoulder rest.....	<b>17.05</b>

### PLAYERS

<b>EVPS</b>	1/8 - 1/4 Size Violin.....	<b>\$2.85</b>
<b>EVPM</b>	1/2 - 3/4 Size Violin.....	<b>2.95</b>
<b>EVPL</b>	3/4 - 4/4 Size Violin.....	<b>3.10</b>

### SOFTIE

<b>BSVP</b>	BIGSOFTIE.....	<b>\$10.45</b>
<b>SSVP</b>	SLIMSOFTIE.....	<b>9.95</b>

### WE BAD

<b>MTDVPTK</b>	Thick.....	<b>\$10.60</b>
<b>MTDVPTN</b>	Thin.....	<b>10.10</b>

## SHOULDER RESTS



### PLAYONAIR

<b>PL1611</b>	Deluxe.....	<b>\$28.50</b>
<b>PL1613</b>	Standard.....	<b>22.50</b>
<b>PL1614</b>	Junior.....	<b>21.00</b>



### RESONANS

<b>14RESSL</b>	1/4 Low, Violin.....	
<b>14RESSM</b>	1/4 Medium, Violin.....	
<b>12RESSL</b>	1/2 Low, Violin.....	
<b>12RESSM</b>	1/2 Medium, Violin.....	
<b>34RESSL</b>	3/4, Low, Violin.....	
<b>34RESSM</b>	3/4, Medium, Violin.....	
<b>5325H</b>	High, Violin.....	
<b>5325M</b>	Medium, Violin.....	
<b>5325L</b>	Low, Violin.....	<b>\$17.25</b>
<b>50199</b>	Rubber Feet.....	<b>.20</b>
<b>5668H</b>	High, Viola.....	
<b>5668M</b>	Medium, Viola.....	
<b>5668L</b>	Low, Viola.....	<b>\$18.75</b>
<b>50199</b>	Rubber Feet.....	<b>.20</b>

### CLARK

<b>LFP</b>	Large Foam Pad.....	<b>\$5.00</b>
<b>SFP</b>	Small Foam pad.....	<b>4.00</b>

## EVEREST



<b>EZ1A</b>	1/4-1/10 Violin.....	<b>\$18.99</b>
<b>EZ2A</b>	1/2 Violin.....	<b>18.99</b>
<b>EZ3A</b>	3/4 Violin.....	<b>18.99</b>
<b>EZ4A</b>	4/4 Violin.....	<b>18.99</b>
<b>EW4</b>	4/4 Violin, Flamed Wood Style.....	<b>29.90</b>
<b>EC4</b>	Collapsible Rest 4/4-1/2, Violin.....	<b>29.89</b>
<b>EZVA</b>	Viola.....	<b>27.60B</b>
<b>EZPOUCH</b>	Pouch for Rest.....	<b>6.00</b>

### EVEREST IN COLORS

<b>ES1</b>	1/4-1/10 Violin.....	<b>\$26.78</b>
<b>ES2</b>	1/2-3/4 Violin.....	<b>26.78</b>
<b>ES4</b>	4/4 Violin.....	<b>26.78</b>
<b>ECS4</b>	Collapsible Rest 4/4-1/2.....	<b>37.80</b>
<b>ESVA</b>	Viola Rest.....	<b>39.38</b>

(W) White, (SI) Silver, (BK) Black,  
(BR) Brown, (G) Green, (B) Blue,  
(PU) Purple, (HPI) Hot Pink, (LPI) Lite Pink

### FEET

<b>FL4A</b>	Standard.....	<b>\$6.00</b>
<b>FL4X</b>	Xtra Long.....	<b>6.00</b>



### WOLF

Fully adjustable angle and width.		
<b>WR1</b>	Forte Primo 4/4, 3/4.....	<b>\$59.99</b>
<b>WR2</b>	Forte Secondo 4/4, 3/4.....	<b>59.99</b>
<b>WR3</b>	Super Flexible.....	<b>74.99</b>
<b>WR22</b>	Secondo 1/2, 1/4.....	<b>59.99</b>
<b>WR4</b>	Viola Forte Primo.....	<b>59.99</b>
<b>WR5</b>	Viola Forte Secondo.....	<b>64.99</b>
<b>WR51</b>	Rubber Feet (2).....	<b>19.99</b>
<b>WRKIT</b>	Rubber Tube Kit.....	<b>14.99</b>

## SHOULDER RESTS



<b>KUN</b>		
<b>KR1</b>	4/4 Violin.....	<b>\$52.50</b>
<b>KR2</b>	3/4 & 1/2 Violin.....	<b>50.25</b>
<b>KR3</b>	1/4 & 1/8 Violin, B, G, R, Y.....	<b>42.00</b>
<b>KR4</b>	Viola.....	<b>56.55</b>
<b>KR5</b>	Violin, Super Rest.....	<b>51.05</b>
<b>KR6</b>	Viola, Super Rest.....	<b>54.00</b>
<b>KR7</b>	KR1 w/collapsible legs.....	<b>56.25</b>
<b>KR8</b>	Violin, Super Rest, 3/4, 1/2.....	<b>49.50</b>
<b>KR9</b>	KR4 w/collapsible legs.....	<b>59.25</b>
<b>KR10</b>	KR2 w/collapsible legs.....	<b>53.25</b>
<b>KR11</b>	KR3 w/collapsible legs, B,G,R,Y.....	<b>45.75</b>
	B-Blue, G-Green, R-Red	
<b>KR12</b>	4/4 Violin, wood finish, Bravo.....	<b>132.00</b>
<b>KR13</b>	Viola, Wood, Bravo.....	<b>138.00</b>



### FORK MEMBERS

<b>KR311</b>	Fits KR1, 4, 5 & 6.....	<b>\$12.60</b>
<b>KR211</b>	Fits KR2.....	<b>12.60</b>
<b>KR111</b>	Fits KR3.....	<b>12.60</b>
<b>KR311XL</b>	Fits KR7.....	<b>14.20</b>

(Specify L-Long, S-Short Screw)



### END MEMBERS

<b>KR310</b>	Fits KR1, 2 & 4.....	<b>\$9.00</b>
<b>KR110</b>	Fits KR3.....	<b>8.35</b>
<b>KR510</b>	Fits KR5 & KR8.....	<b>11.50</b>
<b>KR610</b>	Fits KR6.....	<b>11.50</b>
<b>KR310C</b>	Fits KR7.....	<b>11.05</b>
<b>KR410C</b>	Fits KR9.....	<b>11.05</b>

(Specify H-High, L-Low)



### NUTS

<b>KR312</b>	Fits KR1 & 4.....	<b>\$1.45</b>
<b>KR512</b>	Fits KR5, 6 & 8.....	<b>2.55</b>
<b>KR312C</b>	Fits KR7.....	<b>1.45</b>



### TUBING

<b>KR213</b>	Fits KR2 & 3.....	<b>\$1.90</b>
<b>KR313</b>	Fits KR1 & 7.....	<b>1.90</b>



### INSERTS

<b>KR510A</b>	2 Hole fits KR5, 6, & 8.....	<b>\$3.45</b>
<b>KR510B</b>	1 Hole fits KR5, 6, & 8.....	<b>3.45</b>

## PILLOW PADS



<b>1323</b>	C Model, Small, Poehland.....	<b>\$10.80</b>
<b>1321</b>	C Model, Flocked, Poehland.....	<b>10.80</b>
<b>GL3612</b>	Pillow pad, Glaesel.....	<b>12.00</b>

## STRAD PAD



<b>STRADS</b>	Standard, velcro.....	<b>\$29.00</b>
<b>STRADL</b>	Large, velcro.....	<b>35.75</b>
<b>STRADSCE</b>	Standard, elastic.....	<b>45.50</b>
<b>STRADLCE</b>	Large, elastic.....	<b>52.30</b>

## VIOLIN BRIDGES

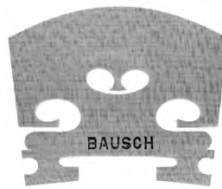

### BAUSCH

Good quality maple.

<b>5400</b>	Full size.....	<b>\$6.45</b>
<b>5401</b>	3/4 size.....	<b>6.45</b>
<b>5402</b>	1/2 size.....	<b>6.45</b>
<b>5403</b>	1/4 size.....	<b>6.45</b>
<b>5404</b>	1/8 size.....	<b>6.45</b>
<b>5399</b>	1/16 size.....	<b>6.45</b>
<b>VP201</b>	Full size.....	<b>1.60</b>
<b>14PV117</b>	1/4 size.....	<b>4.50</b>
<b>110PV117</b>	1/10 size.....	<b>4.40</b>

### FITTED AUBERT

Good quality flamed maple, notched and fitted.

<b>5405</b>	Full size.....	<b>\$9.15</b>
<b>5406</b>	3/4 size.....	<b>9.15</b>
<b>5407</b>	1/2 size.....	<b>9.15</b>



### "E" INSERT

Fine quality flamed maple. Ebony E-string insert.

<b>5408</b>	Full size.....	<b>\$10.20</b>
-------------	----------------	----------------

Fitted. Better quality flamed maple.

<b>5466</b>	Fitted, 3/4 size.....	<b>\$12.45</b>
<b>5467</b>	Fitted, 1/2 size.....	<b>12.45</b>

### AUBERT

<b>5200</b>	Full size.....	<b>\$7.45</b>
<b>5205</b>	Full size, ebony insert.....	<b>33.90</b>
	Old, very fine grain treated wood, fitted.	
<b>5215</b>	Full size.....	<b>\$6.30</b>
	Beautiful speckled wood, fitted.	



### AUBERT ADJUSTABLE

Available in full size, 3/4 size, and 1/2 size. In low, medium, and high with E insert.

<b>SA1</b>	.....	<b>\$41.00</b>
------------	-------	----------------

## VIOLA BRIDGES

<b>5650</b>	Imported, good quality maple.....	<b>\$7.65</b>
-------------	-----------------------------------	---------------

### ADJUSTABLE

Available in low, medium and high.

<b>SA4</b>	Aubert.....	<b>\$39.90</b>
------------	-------------	----------------

## CELLO BRIDGES



### FITTED

<b>5859</b>	Bausch, 4/4.....	<b>\$43.35</b>
<b>5860</b>	Bausch, 3/4.....	<b>43.35</b>
<b>5861</b>	Bausch, 1/2.....	<b>43.35</b>
<b>5870</b>	Pampi, 3/4.....	<b>49.70</b>
<b>5862</b>	4/4, Fine quality.....	<b>83.55</b>
<b>5858</b>	1/4 good quality.....	<b>30.05</b>
<b>5850</b>	Unfitted, Bausch, 3/4.....	<b>31.40</b>
<b>5849</b>	Unfitted, Bausch, 4/4.....	<b>31.40</b>

### AUBERT ADJUSTABLE

Full size. Available in high, medium and low, 3/4 size available in medium and low.

<b>SA5</b>	.....	<b>\$131.60</b>
------------	-------	-----------------

## BASS BRIDGES



<b>5946</b>	Dresden, 1/2.....	<b>\$98.30</b>
<b>5948</b>	Bausch, 3/4.....	<b>83.95</b>
<b>5949</b>	3/4, fine quality.....	<b>74.40</b>

### ADJUSTABLE

<b>GL33693</b>	Glaesel, L, M, or H w/Wheel.....	<b>\$185.00</b>
----------------	----------------------------------	-----------------

## VIOLIN PEGS



### QUALITY EBONY

<b>CC1101</b>	4/4.....	<b>\$1.95</b>
<b>CC1112</b>	3/4.....	<b>1.95</b>
<b>CC1113</b>	1/2.....	<b>1.95</b>
<b>CC1114</b>	1/4.....	<b>1.95</b>
<b>CC1115</b>	1/8.....	<b>1.95</b>
<b>CC1116</b>	1/16.....	<b>1.95</b>
<b>5446</b>	1/8 size.....	<b>3.75</b>

### FINE EBONY

<b>5451</b>	Full size.....	<b>\$1.77</b>
<b>VP140</b>	Set, specify size.....	<b>9.45</b>

### ROSEWOOD

<b>5457</b>	Full size.....	<b>\$6.40</b>
<b>CC1301</b>	Full size.....	<b>1.95</b>

### SELECT EBONY

<b>5454</b>	Full size.....	<b>\$6.30</b>
-------------	----------------	---------------

### HILL, EBONY

<b>5455</b>	4/4.....	<b>\$6.30</b>
<b>CC1104</b>	4/4.....	<b>2.40</b>

### FRICTION PEGS

<b>5B</b>	4/4 size.....	<b>\$36.95 set</b>
-----------	---------------	--------------------

## PEGS



<b>VIOLA</b>		
CC4101	Ebony .....	\$2.45
VP140V	Ebony, set .....	10.45



<b>CELLO</b>		
Imported high grade ebony.		
5877	1/2 size .....	\$24.30
VP140C	Full size .....	26.20 set
CC6201	4/4 .....	10.90
CC6204	3/4 .....	10.90
CC6205	1/2 .....	10.90

## VIOLIN END PINS



5481	Good quality ebony .....	\$1.00
VP120	Ebony, Plain .....	2.05
CC2031	Ebony, Plain .....	1.30

## VIOLIN PICK UPS



SS9200	Super Sensitive .....	\$74.60
SS9210	Super Sensitive w/vol. ....	89.70
SS9204	Adhesive .....	4.75



SH3000	Shadow w/ vol. control .....	\$149.95
SH3001	Shadow .....	99.95



FTV100	Fishman .....	\$190.75B
FTV200	Fishman .....	277.45B
FTV300VI	Fishman Concert .....	329.50B

## TAILPIECES



<b>EBONIZED</b>		
5425	Violin, full size .....	\$10.30
5426	Violin, 3/4 size .....	10.30
5427	Violin, 1/2 size .....	10.30



<b>QUALITY EBONY</b>		
5433	Violin, full size .....	\$16.05
5434	Violin, 3/4 size .....	16.05
VP66	Violin, specify size .....	10.60
CC1801	Violin, full size .....	10.90

<b>HILL</b>		
Available in full size.		
5438	Ebony .....	\$30.50
5436	Rosewood .....	27.75
CC1802	Ebony .....	10.90
CC1902	Rosewood .....	7.10

<b>HILL BOXWOOD</b>		
CC1702	Full Size .....	\$10.90

<b>VIOLA TAILPIECES</b>		
5657	Fine grade, ebony .....	\$19.30
VP66V	Ebony .....	10.45

## HOLDERS



CC08	Attaches to stand lip .....	\$15.00
CCIV	Violin with bow holder .....	14.10
MHVL	Clips on music stand lip. ....	14.82
KM155	Violin holder, attaches to stands..	45.99
CC04	Clip on Mic Stand .....	15.00
CC04V	Clip on Stand w/Holder .....	15.00
CC01V	Violin, Wall Mount .....	15.00
KM16580	Violin, Wall Mount .....	37.99
KM15580	Violin, Felt lined clip on stand .....	45.99

## TAILGUT

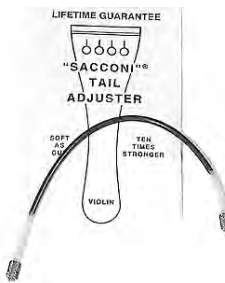

<b>SACCONI</b>		
SVG	Violin .....	\$4.50
34SVG	3/4, 1/2 Violin .....	4.20
SVV	Viola .....	4.50
SCG	Cello .....	9.00
34SCG	3/4 Cello .....	9.00
SBG	Bass .....	19.80

<b>SIEGLER</b>		
VP64	Violin .....	\$1.35
VP64V	Viola .....	1.35
VP64C	Cello .....	6.25

## TAILPIECES



<b>CELLO TAILPIECES</b>		
5891	Ebony, full size .....	\$47.30
5890	Ebony, 3/4 size .....	47.30
CC7102	Specify size .....	30.45
VP66C	Ebony, 4/4 size .....	31.45

<b>BASS TAILPIECE</b>		
5999	Fine quality ebony .....	\$196.45
CC8201	Ebony .....	100.20



<b>THOMASTIK ANODIZED (ADJUSTABLE)</b>		
DRT212	Full size violin .....	\$91.25

<b>SAGA (ADJUSTABLE)</b>		
44VP62	Full size violin .....	\$5.80
34VP62	3/4 size violin .....	5.80
12VP62	1/2 size violin .....	5.80
VP61	4/4 violin, black anodized .....	11.50

<b>PALATINO</b>		
PV120	Violin, Specify size .....	\$16.35



<b>WITNER (ADJUSTABLE) ULTRA METAL</b>		
W918111	4/4 Size Violin .....	\$28.20
W918121	3/4 Size Violin .....	28.20
W918131	1/2 Size Violin .....	28.20
W918141	1/4 Size Violin .....	28.20
W918151	1/8 Size Violin .....	28.20
W918161	1/16 Size Violin .....	28.20
W919131	16" Viola .....	33.75
W919151	15" Viola .....	33.75
W919711	4/4 Cello .....	43.95
W919731	3/4, 1/2 Cello .....	43.95
W919751	1/4, 1/8 Cello .....	43.95



<b>WITNER CLASSIC ULTRA METAL</b>		
W260111	4/4, Violin w/tailgut .....	\$16.50
W260611	4/4, Violin w/Multi Adj. ....	29.00
W918611	4/4, Violin w/Tunes .....	40.70

## BOW FROGS



### VIOLIN

#### Glasser Model

GFV44	4/4 & 3/4.....	\$22.50
GFV12	1/2 & 1/4.....	22.50

### VIOLA (Half Lined)

GVF	Glasser .....	22.50
-----	---------------	-------

### CELLO (Half Lined)

GCF	Glasser .....	22.50
-----	---------------	-------

### BASS

GFBF	Glasser, French.....	30.00
GGBF	Glasser, German .....	30.00

### WEDGES

5318	Violin .....	\$1.50
------	--------------	--------

## NUTS & SADDLES



Better quality, imported ebony

5485	Violin nut, finished .....	\$2.40
5486	Violin saddle, unfinished.....	.70
5487	Violin saddle, finished .....	1.35
CC2091	Violin saddle, finished .....	2.20
CC2391	Cello nut, finished .....	3.80
5898	Cello nut, finished .....	5.20
5892	Cello saddle, finished.....	5.55

## DAMPITS



Prevents cracking warping & shrinking due to moisture loss.

VPIT	Violin .....	\$21.70
MINIVPIT	Violin, Small .....	20.70
APIT	Viola .....	22.25
CPIT	Cello .....	23.50
BPIT	Bass .....	25.00

## HUMITRONS



DAMPV	Violin .....	\$8.55
DAMPV	Cello .....	9.00
DAMPB	Bass .....	10.20

## SOUNDPOSTS



SP930	Spruce, 7/stick, violin .....	\$7.55
SP929	Spruce, Viola, 7/stick .....	8.40
SP932	Spruce, cello, 2/stick .....	12.70
SP934	Spruce, Bass, stick.....	14.15

## SOUNDPOST SETTERS



PV002	Violin/viola setter.....	\$3.15
SV	Violin Soundpost setter .....	3.70
ST	Scissors setter.....	24.95
SS575	Scissor setter.....	10.05
VSPS	Violin setter .....	18.90

## PEG REAMERS



5063	Violin .....	\$207.75
------	--------------	----------

## FINGERBOARDS



### FINGERBOARDS

5370	Violin, 3/4 size .....	\$32.80
5371	Violin, 1/2 size.....	32.80
CC2095	Violin, Full Size .....	26.10
5660	Viola.....	46.20
5894	Cello .....	81.00
5976	Bass.....	144.00
VP115	Violin, Full Size .....	12.60

## ROSINS



### BASS

SR-3	Sherman.....	\$5.05
59822	Petz, soft.....	13.95
59823	Petz, medium .....	13.95
59824	Petz, hard.....	13.95
POPS	POPS Brand.....	14.15
SS915	Super Sensitive, Light.....	9.60
SS916	Super Sensitive, Dark .....	9.60
CSR	Carlson .....	20.25
SS9252	Hypo allergenic, Lite .....	17.50
SS9253	Hypo allergenic, Dark .....	17.50

## ROSINS



### VIOLIN

SS911	Super Sensitive, Light.....	\$4.76
SS912	Super Sensitive, Dark .....	4.76
SS914L	Super Sensitive Pro, Light.....	9.70
SS914D	Super Sensitive Pro, Light.....	9.70
SS913L	Super Sensitive Pro, Mini, Lite.....	2.60
SS913D	Super Sensitive Pro, Mini, Dark .....	2.60
SS906R	Large Amber rosin in Wood.....	3.85
SS907R	Large Symphonic (Dark), Wood.....	3.85
LVR0S	Larsen .....	34.65
KACR6	Kaplan Artcraft, Light .....	10.50
KACR7	Kaplan Artcraft, Dark .....	10.50
KRDD	Kaplan Premium Dark.....	16.00
KRDL	Kaplan Premium Lite .....	16.00
1V	Hidersine Violin, Round, Large .....	9.15
3V	Hidersine Violin, Round, Small .....	7.65
LS	"London Special" by Hidersine.....	10.70
VR200	Daddario, Lite .....	5.80
VR300	Daddario, Dark .....	5.80
PV005	Student .....	1.20
GL3913	Glaesel.....	8.00
R1100G	Motrya Gold Rosin.....	17.55
R1000PD	Wood Frame, Dark.....	2.55
R1000PL	Wood Frame, Light .....	2.55
R1100M	Mini Rosin .....	2.20
1665	Rao violin rosin wood case .....	5.00
23/15	W.E. Hill - packed in felt, Light .....	17.30
23/16	W.E. Hill - packed in felt, Dark .....	17.30
HC03D	H. Core packed in felt, Dark .....	7.00
HC03L	H. Core packed in felt, Light.....	7.00
SR1	Sherman, Light .....	4.60
SR1D	Sherman, Dark .....	4.60
G70	Paganini round rosin on cloth.....	6.20
G77	Paganini - booklet - cork case.....	4.25
5950	Petz round cake rosin on cloth.....	13.00
G95	Paganini Powdered Rosin.....	5.45
FR211	Frost Rosin .....	2.90
FR214	Frost Mini Rosin .....	2.25
KDR	Kafko Dark, wood case .....	2.80
KLR	Kafko Light, wood case .....	2.80
GL3960	Violin/Cello A/B .....	9.00
DRT203	DR. Thomastik .....	18.50
DRT200A	DR. Thomastik .....	19.90
5953	Rosin Remover.....	12.00

### HYP0 ALLERGENIC

P9001	Pirastro .....	\$25.95B
SS9250	Super Sensitive .....	17.50
SS9254	Super Sensitive Purple.....	17.50
SS9255	Super Sensitive Green .....	17.50
SS9256	Super Sensitive Blue.....	17.50
SS9257	Super Sensitive Red .....	17.50
SS9259	Super Sensitive Pink .....	17.50



### CELLO

SR-2	Sherman.....	\$4.60
5951	Petz .....	13.00
1C	Hidersine .....	9.15
GL3914	Glaesel, Lite .....	8.00
SS9251	Hypo Allergenic.....	17.50
LCROS	Larsen .....	34.65



# SUPER SENSITIVE BOW STRINGS

## RED LABEL



## RED LABEL PEARL



## SENSICORE

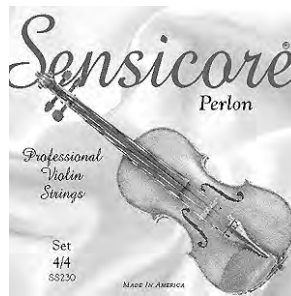

## PINNACLE

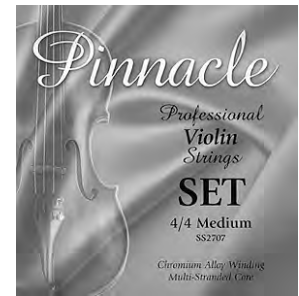

### VIOLIN

4/4 size: Soft tone, Medium tone, Orchestra tone. (3/4, 1/2, 1/4, 1/8 and 1/16 sizes. Orch. only)

SS211	E plain	\$3.90
SS211F	E flat-wound	6.95
SS231G	E, Gold	62.50
SS212	A flat-wound	8.55
SS213	D flat-wound	9.20
SS214	G flat-wound	9.50
SS210	Complete set	31.15

### VIOLA

Standard size: Orchestra tone. Intermediate (14"), Junior (13"), and mini sizes.

SS411	A flat-wound	\$8.50
SS412	D flat-wound	11.95
SS413	G flat-wound	13.10
SS414	C flat-wound	15.70
SS410	Complete set	49.20

### CELLO

4/4 size: Soft tone, Medium tone, Orchestra tone. 3/4, 1/2, 1/4 and 1/8 sizes. Orch. tone only

SS611	A flat-wound	\$19.35
SS612	D flat-wound	22.30
SS613	G flat-wound	27.30
SS614	C flat-wound	29.70
SS610	Complete set	98.65

### BASS

Regular (3/4), Extra-Long (7/8) and Junior (1/2) Sizes.

SS811	C flat-wound	\$27.90
SS812	G flat-wound	33.50
SS813	D flat-wound	37.90
SS814	A flat-wound	44.65
SS815	E flat-wound	50.20
SS816	C (Low) - Flat	59.10
SS810	Complete set (G,D,A,E)	166.20

### RED LABEL VIOLIN BULK STRINGS

Packaged in a pack of 12

SS211B	E Violin	\$33.45 pk.
SS212B	A Violin	73.30 pk.
SS213B	D Violin	78.85 pk.
SS214B	G Violin	81.45 pk.

## WOLF ELIMINATORS



SS9450	Violin/Viola, super sensitive	\$13.00
SS9451	Cello/Bass, super sensitive	19.50
WE1	Violin/Viola	18.90
WE2	Cello	27.85
WE3	Bass	36.40

### VIOLIN

Full size, synthetic core.

SS230	Complete set	\$69.95
-------	--------------	---------

### VIOLA

4/4 size only, synthetic core.

SS430	Complete set	\$113.39
-------	--------------	----------

### BASS

3/4 size only

SS830	Complete set	\$283.65
-------	--------------	----------

### OLD FIDDLER

#### VIOLIN

4/4 size: Medium tone

SS240	Complete set	\$34.60
-------	--------------	---------

### PEARL RED LABEL

#### Nylon Core

#### VIOLIN

4/4 size, Medium tone, (3/4, 1/2, 1/4, 1/8 and 1/16 sizes. Nylon core, copper eyelets, polished windings. Free bonus E string in every set.

SS221	Pearl Violin E String	\$4.25
SS222	Pearl Violin A String	10.05
SS223	Pearl Violin D String	17.25
SS224	Pearl Violin G String	19.50
SS220	Complete Set	55.30

## FIRST FRETS

Position Markers

GLDF115	1/16 Violin	\$3.55
GLDF116	1/10 Violin	3.55
GLDF117	1/8 Violin	3.55
GLDF118	1/4 Violin	3.55
GLDF119	1/2 Violin	3.55
GLDF120	3/4 Violin	3.55
GLDF121	4/4 Violin	3.55
GLDF125	3/4 Cello	7.10
GLDF126	4/4 Cello	7.10

## DON'T FRET

Vinyl Base Applique replaces tape on the fingerboard.

GLDF106	4/4 Violin	\$7.10
GLDF105	3/4 Violin	7.10
GLDF104	1/2 Violin	7.10
GLDF103	1/4 Violin	7.10
GLDF102	1/8 Violin	7.10
GLDF101	1/10 Violin	7.10
GLDF100	1/16 Violin	7.10
GLDF110	4/4 Cello	14.20
GLDF109	3/4 Cello	14.20
GLDF108	1/2 Cello	14.20
GLDF107	1/4 Cello	14.20

### ROPE CORE

VIOLIN — 4/4 Size

SS271	E	Chromium Steel	\$4.80
SS271F	E	Chromium Steel	8.80
SS274	G	Chromium Steel	21.30
SS270	Set	Chromium Steel	58.45

VIOLA — Standard Size

SS471	A	Chromium Steel	\$13.70
SS473	G	Chromium Steel	23.45
SS474	C	Chromium Steel	28.65
SS474T	C	Tungsten Steel	28.65

CELLO — 4/4 Size

SS671	A	Chromium Steel	\$26.80
SS672	D	Chromium Steel	33.25
SS673	G	Chromium Steel	69.20
SS673T	G	Tungsten Steel	69.20
SS674	C	Chromium Steel	90.45
SS674T	C	Tungsten Steel	90.45
SS670	Set	Chromium Steel	219.70

ORCHESTRA BASS — 3/4 Size Only

SS8737	D	Chromium Steel	\$56.60
SS8747	A	Chromium Steel	67.55
SS8757	E	Chromium Steel	75.95
SS8759	E(Ext.)	Chromium Steel	75.95
SS8767	C(Lo)	Chromium Steel	95.35
SS8707	Set	Chromium Steel	248.25

SOLO BASS — 3/4 Size Only

SS8721	A	Chromium Steel	\$48.15
SS8731	E	Chromium Steel	56.60
SS8741	B	Chromium Steel	67.55
SS8751	F#	Chromium Steel	95.85
SS870	Set	Chromium Steel	248.25

### TRANSITIONS ELECTRIC VIOLIN SET



#### VIOLIN

Sizes 4/4, 3/4, 1/2

SS9231	E Plain	\$4.70
SS9232	A Wound Aluminum	16.22
SS9233	D Silver Wound	25.40
SS9234	G Silver Wound	26.87
SS9230	Complete Set	73.19

# D'ADDARIO BOWED STRINGS

## Helicore

Helicore's multi-strand, twisted steel core strings have a small string diameter, providing a quick bow response. Thanks to special manufacturing techniques, the Helicore strings have a warm, clear sound with excellent pitch stability and longevity.



## Violin Strings

<b>H311</b>	E-tinned high-carbon steel .....	<b>\$8.00</b>
<b>H311W</b>	E-aluminum wound .....	<b>14.75</b>
<b>H312</b>	A-aluminum wound .....	<b>20.25</b>
<b>H313</b>	D-titanium wound .....	<b>24.50</b>
<b>H314</b>	G-silver wound .....	<b>28.75</b>
<b>H310</b>	Set coiled .....	<b>80.00</b>
<b>H310W</b>	Set coiled-(aluminum E) .....	<b>87.25</b>

Fractional sizes available

## Viola Strings

<b>H411</b>	A-aluminum wound .....	<b>\$21.75</b>
<b>H412</b>	D-titanium wound .....	<b>25.75</b>
<b>H413</b>	G-silver wound .....	<b>27.25</b>
<b>H414C</b>	C-tungsten/silver wound .....	<b>35.00</b>
<b>H410</b>	Set coiled .....	<b>110.50</b>

Long scale 16" and over, medium scale (15" - 16").  
LM or MM.

## Cello Strings

<b>H511</b>	A-titanium wound .....	<b>\$39.00</b>
<b>H512</b>	D-titanium wound .....	<b>41.25</b>
<b>H513</b>	G-tungsten/silver wound .....	<b>87.25</b>
<b>H514</b>	C-tungsten/silver wound .....	<b>108.25</b>
<b>H510</b>	Set coiled .....	<b>270.00</b>

Fractional sizes available

## Helicore Bass Strings

### Orchestral Bass Strings

Designed for the artist who plays primarily arco. Exceptional bow response.

<b>H611</b>	G-nickel wound .....	<b>\$60.75</b>
<b>H612</b>	D-nickel wound .....	<b>68.00</b>
<b>H613</b>	A-nickel wound .....	<b>77.50</b>
<b>H614</b>	E-nickel wound .....	<b>90.75</b>
<b>H615</b>	C-(extnd. E) nickel wound .....	<b>102.50</b>
<b>H610</b>	Set, Orchestral .....	<b>297.00</b>
<b>HS610</b>	Set, Solo .....	<b>297.00</b>
<b>HP610</b>	Set, Pizzicato .....	<b>297.00</b>

Available in medium tension.

Extended E & low B sold as single strings only.

Fractional sizes available

### Hybrid Bass Strings

Designed for the player who performs a mixture of arco and pizzicato. Excellent pizzicato sustain and attack. Quick, accurate bow response. A universal choice for the player required to perform a broad range of musical styles.

<b>HH611</b>	G-nickel wound .....	<b>\$60.75</b>
<b>HH612</b>	D-nickel wound .....	<b>68.00</b>
<b>HH613</b>	A-nickel wound .....	<b>77.50</b>
<b>HH614</b>	E-nickel wound .....	<b>102.50</b>
<b>HH615</b>	C-(extnd. E) nickel wound .....	<b>94.50</b>
<b>HH616</b>	low B-nickel wound .....	<b>99.00</b>
<b>HH610</b>	Set coiled .....	<b>297.00</b>

Available in 3/4 size only in medium.

Extended E & low B sold as single strings only

### Helicore Bass Strings continued Hybrid Bass Strings

<b>12HH611</b>	G Medium .....	<b>\$49.75</b>
<b>12HH612</b>	D Medium .....	<b>59.00</b>
<b>12HH613</b>	A Medium .....	<b>75.25</b>
<b>12HH614</b>	E Medium .....	<b>87.00</b>
<b>12HH610</b>	Set, Coiled .....	<b>268.25</b>

### Solo Bass Strings

Designed for the solo/orchestral player. A-E-B-F# tuning. Exceptional bow response.

<b>HS610</b>	Set coiled .....	<b>\$297.00</b>
--------------	------------------	-----------------

Available in 3/4 size only, medium tension only.

### Zyex®

Zyex is a new generation of synthetic material. Created for stability in drastic climatic conditions, it settles in faster than any other synthetic material.



### Violin Strings

<b>DZ311</b>	E-tinned high carbon steel .....	<b>\$8.50</b>
<b>DZ312</b>	A-aluminum wound .....	<b>23.50</b>
<b>DZ313A</b>	D-aluminum wound .....	<b>33.75</b>
<b>DZ314</b>	G-silver wound .....	<b>34.75</b>
<b>DZ310A</b>	Set coiled-(aluminum D) .....	<b>96.00</b>
<b>DZ310S</b>	Set coiled-(Silver D) .....	<b>102.75</b>

Available in 4/4 size only; light, medium, & heavy tensions.

### Prelude

Solid steel core string that is durable and not affected by temperature and humidity changes. Prelude strings have a clear, bright sound without the shrill sound of traditional steel strings and have a quick bow response.

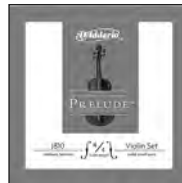

### Violin Strings

<b>J811</b>	E*-tinned high carbon steel .....	<b>\$5.75</b>
<b>J812</b>	A-aluminum wound .....	<b>9.25</b>
<b>J813</b>	D-nickel wound .....	<b>9.75</b>
<b>J814</b>	G-nickel wound .....	<b>10.25</b>
<b>J810</b>	Set coiled .....	<b>34.75</b>

Available in 4/4 3/4 1/2 1/4 1/8, (fits 1/10), & 1/16. Fractional sizes available only in medium tension.

4/4 size sets available in light, medium, & heavy tensions. Specify when ordering.

### Viola Strings

<b>J911</b>	A .....	<b>\$13.00</b>
<b>J912</b>	D .....	<b>13.25</b>
<b>J913</b>	G .....	<b>14.50</b>
<b>J914</b>	C .....	<b>15.75</b>
<b>J910S</b>	Short Set .....	<b>54.25</b>
<b>J910M</b>	Full Set .....	<b>54.25</b>
<b>J910L</b>	Long Set .....	<b>54.25</b>

Add M, i.e., SM, MM, LM

### Cello Strings

<b>J1011</b>	A - Nickel .....	<b>\$25.50</b>
<b>J1011A</b>	A - Aluminum, Wound .....	<b>28.75</b>
<b>J1012</b>	D - Nickel .....	<b>27.25</b>
<b>J1013</b>	G - Nickel .....	<b>29.75</b>
<b>J1014</b>	C - Nickel .....	<b>32.75</b>
<b>44J1010M</b>	Cello Set .....	<b>112.50</b>

### Bass Strings

<b>J610</b>	Bass set, all sizes .....	<b>\$172.00</b>
<b>J611</b>	G - Stainless Steel .....	<b>35.00</b>
<b>J612</b>	D - Stainless Steel .....	<b>38.25</b>
<b>J613</b>	A - Stainless Steel .....	<b>46.50</b>
<b>J614</b>	E - Stainless Steel .....	<b>53.25</b>

## Pro-Arté

Nylon core string that is resistant to humidity and temperature changes, with a moderate break-in period. Pro Arte strings have a warm sound and a good bow response.

### Violin Strings

<b>J5601</b>	E*-tinned high carbon steel .....	<b>\$6.50</b>
<b>J5602</b>	A-aluminum wound .....	<b>16.00</b>
<b>J5603</b>	D-aluminum wound .....	<b>16.75</b>
<b>J5604</b>	G-silver wound .....	<b>20.25</b>
<b>J56</b>	Set coiled (aluminum D) .....	<b>58.75</b>

Available in all sizes.

Fractional sizes available in medium tension only.



### Viola Strings

<b>J5801</b>	A Viola .....	<b>\$18.50</b>
<b>J5802</b>	D Viola .....	<b>19.25</b>
<b>J5803</b>	G Viola .....	<b>22.00</b>
<b>J5804</b>	C Viola .....	<b>34.00</b>
<b>J58</b>	Viola Set .....	<b>91.25</b>

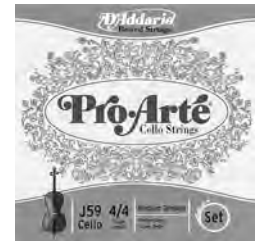

### Cello Strings

<b>J5901</b>	A Aluminum .....	<b>\$29.50</b>
<b>J5902</b>	D Silver .....	<b>37.25</b>
<b>J5903</b>	G Silver .....	<b>46.25</b>
<b>J5904</b>	C Silver .....	<b>70.25</b>
<b>J59</b>	Cello Set .....	<b>180.50</b>



## Kaplan Solutions

### Viola

<b>KS411LH</b>	KS Titanium A Long Hvy .....	<b>\$29.50</b>
<b>KS411LL</b>	KS Titanium A Long Lgt .....	<b>29.50</b>
<b>KS411LM</b>	KS Titanium A Long Med .....	<b>29.50</b>

### Violin

<b>KS311W</b>	KS Non-Whistling E .....	<b>\$17.75</b>
---------------	--------------------------	----------------

# THOMASTIK-INFIELD BOWED STRINGS

## DOMINANT (Perlon Core)

Dominant Strings are recognized as the reference standard. Perlon Core offers the sound and feel of gut with the exceptional stability of a synthetic core. The tone is soft, clear, and rich in overtones; live, full and brilliant.



### VIOLIN STRINGS

<b>DRT129SN</b>	E	Carbon steel, tin plated	\$ 6.40
<b>DRT129</b>	E	Chrome steel	10.70
<b>BE130</b>	E	Steel core, aluminum wound	17.15
<b>DRT130</b>	E	Steel core, aluminum wound	17.15
<b>DRT131</b>	A	Perlon core, aluminum wound	25.70
<b>DRT132</b>	D	Perlon core, aluminum wound	35.70
<b>DRT132A</b>	D	Perlon core, silver wound	39.00
<b>DRT133</b>	G	Perlon core, aluminum wound	39.00
<b>DRT135</b>	SET		116.40
<b>DRT135BE</b>	SET	ball end	116.40

### VIOLA STRINGS

<b>DRT136</b>	A	Perlon core, aluminum wound	\$29.95
<b>DRT137</b>	D	Perlon core, aluminum wound	34.00
<b>DRT137A</b>	D	Perlon core, silver wound	42.10
<b>DRT138</b>	G	Perlon core, silver wound	47.50
<b>DRT139</b>	C	Perlon core, silver wound	81.20
<b>DRT141</b>	SET		191.00

### CELLO STRINGS

<b>DRT142</b>	A	Perlon core, chrome wound	\$60.10
<b>DRT143</b>	D	Perlon core, chrome wound	84.40
<b>DRT144</b>	G	Perlon core, chrome wound	101.00
<b>DRT145</b>	C	Perlon core, chrome wound	112.40
<b>DRT147</b>	SET		356.50

### BASS STRINGS

<b>DRT190</b>	G	Perlon core, chrome wound	\$114.65
<b>DRT191</b>	D	Perlon core, chrome wound	108.10
<b>DRT196</b>	SET		515.00

### DOMINANT VIOLIN STRINGS

#### PACKAGED IN 12 STRING TUBES

<b>TUBE 130</b>	E	Steel core, aluminum wound	\$205.80
<b>TUBE 131</b>	A	Perlon core, aluminum wound	308.40
<b>TUBE 132</b>	D	Perlon core, aluminum wound	428.40
<b>TUBE 133</b>	G	Perlon core, aluminum wound	468.00

### GOLD E STRING

<b>DRT48MS</b>	E	Chrome steel, chrome plated	\$25.10
----------------	---	-----------------------------	---------

## VISION

(Advanced Synthetic Core)

Wound on an advanced synthetic core, these strings settle in quickly, stay in tune and are highly durable. Vision strings are clear, brilliant and focused.



### VIOLIN STRINGS

<b>DRTVI100</b>	SET-Vision	\$88.80
<b>DRTVIT100</b>	SET-Vision Titanium Solo	157.25
<b>DRTVIS100</b>	SET Solo	140.90
<b>DRTVIS101</b>	SET Solo Silver D	145.00

### VIOLA STRINGS

<b>DRTVI200</b>	SET-Vision	\$181.00
<b>DRTVIS200</b>	SET Solo	210.50

### PRECISION (Steel Core)

Solid steel core provides a brilliant tone.

### VIOLIN STRINGS

<b>DRT50</b>	E	Chrome steel	\$11.00
<b>DRT51</b>	A	Steel core, chrome wound	19.50
<b>DRT53</b>	D	Steel core, chrome wound	20.90
<b>DRT58</b>	SET		75.60

## SPIROCORE

(Steel Spiral Rope Core)

The flexible multi-wire spiral rope core provides less inertia and a longer period of musical vibration. Equally effective when playing arco or pizz; highly responsive and very durable.



### VIOLIN STRINGS

<b>DRTS10</b>	A	Steel core, chrome wound	\$24.70
<b>DRTS15</b>	SET (S9,S10,S12,S13)		120.50

### VIOLA STRINGS

<b>DRTS19</b>	D	Steel core, chrome wound	\$35.90
<b>DRTS20</b>	G	Steel core, chrome wound	43.10

### CELLO STRINGS

<b>DRTS25</b>	A	Steel core, chrome wound	\$47.20
<b>DRTS27</b>	D	Steel core, chrome wound	66.00
<b>DRTS28</b>	G	Steel core, chrome wound	77.80
<b>DRTS28A</b>	G	Steel core, silver wound	126.10
<b>DRTS29</b>	C	Steel core, chrome wound	86.95
<b>DRTS30</b>	C	Steel core, silver wound	174.25

### BASS STRINGS

<b>DRTS36</b>	G	Steel core, chrome wound	\$94.50
<b>DRTS38</b>	A	Steel core, chrome wound	99.80
<b>DRTS42</b>	SET		435.00
<b>DRTS42W</b>	SET	(Heavy Tension)	435.00

## SPIROCORE

<b>DRTSP100</b>	SPIRIT VIOLIN SET	\$ 69.99
-----------------	-------------------	----------

## BELCANTO

(Steel Rope Core)

**Cello:** Designed to provide a brilliant, clear and open tone; the modern sound.

**Bass:** A new arco set; has a unique core, a warm tone with excellent resonance and settles-in quickly.



<b>DRTBC31</b>	CELLO SET	\$498.00
----------------	-----------	----------

## SUPERFLEXIBLE (Steel Rope Core)

Dependable, durable all-purpose string with stable tuning. Steel rope core reduces stiffness and improves elasticity; excellent purity of open fifths.

### VIOLIN STRINGS

<b>DRT9</b>	E	Steel core, aluminum wound	\$15.10
<b>DRT10</b>	A	Steel core, chrome wound	19.20
<b>DRT12</b>	D	Steel core, chrome wound	20.25
<b>DRT15</b>	SET		90.90

### VIOLA STRINGS

<b>DRT18</b>	A	Steel core, chrome wound	\$24.90
--------------	---	--------------------------	---------

### CELLO STRINGS

<b>DRT31</b>	SET (25, 27, 28, 29)	\$228.00
--------------	----------------------	----------

### BASS STRINGS

<b>DRT42</b>	SET (36, 37, 38, 39)	\$335.00
--------------	----------------------	----------

### CELLO STEEL CORE

<b>DRTSP400</b>	SPIRIT CELLO SET	\$224.99
-----------------	------------------	----------

# MAKE A SOUND CHOICE

**VISION**

**RICH**  
Harmonic Content

**BRILLIANT**

**FOCUSSED**  
Harmonic Content

**WARM**

# BOW STRINGS

## PRIM

<b>VIOLIN</b>		
PR223	E Chromesteel	\$8.75
PR224	A Chromesteel/steel	20.10
PR225	D Chromesteel/steel	20.65
PR226	G Chromesteel/steel	22.50
<b>VIOLA</b>		
PR233	A Chromesteel/steel	\$20.70
PR234	D Chromesteel/steel	21.45
PR235	G Chromesteel/steel	20.85
PR236	C Chromesteel/steel	26.85
<b>CELLO</b>		
PR243	A Chromesteel/steel	\$33.95
PR244	D Chromesteel/steel	43.50
PR245	G Chromesteel/steel	47.80
PR246	C Chromesteel/steel	55.10

## JUBILAUM

<b>VIOLIN</b>		
9101	E Steel	\$1.70
9102	A Wound	3.15
9103	D Wound	3.45
9104	G Wound	5.25
<b>VIOLA</b>		
9193	A Wound	\$4.05
9194	D Wound	4.20
9195	G Wound	5.00
9196	C Wound	7.15
<b>CELLO</b>		
9241	A Wound	\$6.75
9242	D Wound	7.50
9244	C Wound	9.55
<b>BASS</b>		
349274	COMPLETE SET	\$95.25
	Specify Size and Number	

## JARGAR

<b>VIOLIN</b>		
J11	E	\$13.00B
J12	A	23.00B
J13	D	25.00B
J14	G	28.00B
<b>VIOLA</b>		
J21	A	\$25.00B
J22	D	28.00B
J23	G	28.00B
J24	C	30.00B
<b>CELLO</b>		
J31	A	\$43.00B
J32	D	48.00B
J33	G	53.00B
J33SM	G, Silver Wound	58.75B
J34	C	58.00B
J34SM	C, Silver Wound	75.00B
<b>BASS</b>		
J41M	G	\$57.80B
J42M	D	63.00B

Specify Forte (F), Medium: (M), Dolce: (D)

## ADAMAS FIDDLE

K8989		\$10.49
-------	--	---------

## LA BELLA

<b>VIOLIN</b>		
630	Complete set	\$34.75
<b>VIOLA</b>		
640	Complete set	\$57.05
<b>CELLO</b>		
650	Complete set (metal)	\$77.15
<b>BASS</b>		
G75	Gut	\$123.90
D76	Gut	135.15
A180	S/P wound on gut	145.35
E181	S/P wound on gut	168.95
980	Complete set	595.00
7710L	Rope Core, Nylon Tape	337.25 set
7720L	Rope Core flat wound	337.25 set
610	Complete set	137.50

## SUPER NIL

G1003	Nylon on nylon	\$43.05
D1004	Nylon on nylon	46.55
A623	Silver PLT on nylon	43.90
E624	Silver PLT on nylon	51.65
1006	Complete set	185.15

## BLACK DIAMOND

<b>VIOLIN</b>		
N719	Complete set	\$9.15

## PIRASTRO

<b>VIOLIN</b>	<b>EUDOXIA</b>	
P3148	E Steel	\$19.35B
P2142	A Gut/Aluminum	43.80B
P2143	D Gut/Aluminum	48.75B
P2144	G Gut/Aluminum	62.55B

<b>VIOLA</b>		
P2243	G Gut/Silver	\$60.30B
P2244	C Gut/Silver	75.90B

<b>BASS</b>		
P1441	G Gut	\$286.95B

<b>VIOLIN</b>	<b>CHROMCOR</b>	
P3191	E (Ball End)	\$8.10B
P3198	E (Loop End)	8.10B
P3192	A	16.20B
P3193	D	19.69B
P3194	G	20.93B

<b>VIOLA</b>		
P3293	G	\$31.80B
P3294	C	32.55B

<b>CELLO</b>		
P3391	A	\$46.65B
P3397	Plus A	56.25B
P3398	Plus D	58.65B
P3392	D	49.20B
<b>BASS</b>		
P3482	D	\$102.90B
P3483	A	104.70B
P3484	E	126.60B

<b>VIOLIN</b>	<b>SYNOXA</b>	
P4134	G Aluminum	\$50.40B
P4130	Complete Set	131.25B

<b>BASS</b>	<b>FLEXOCOR</b>	
P3413	A	\$164.10B
P3414	E	197.40B

<b>VIOLIN</b>	<b>PIRANITO</b>	
P6151	E	\$10.20B
P6152	A	17.25B
P6153	D	18.30B
P6154	G	20.70B
P6150	Complete Set	54.30B
P6350	Cello, Complete Set	170.40B

<b>VIOLIN</b>	<b>ARICORE</b>	
P3108	E	\$10.20B

<b>BASS</b>	<b>FLAT CHROME</b>	
P346005	Complete Set	\$660.30B

## LARSEN

<b>LMVEB</b>	Violin E, Ball End	\$12.54
<b>LMVE</b>	Violin E, Loop End	10.55
<b>LMVA</b>	Violin A	36.30
<b>LMVDAL</b>	Violin D, Aluminum	38.94
<b>LMVDSI</b>	Violin D, Silver	40.92
<b>LMVGSi</b>	Violin G, Silver	41.58
<b>LMVAAB</b>	Viola A, Ball End	47.85
<b>LSMCA</b>	Cello A, Soloist	87.45
<b>LSMCD</b>	Cello D, Soloist	99.00
<b>LMCA</b>	Cello A	75.57
<b>LMCD</b>	Cello D	99.00
<b>LMCG</b>	Cello G	141.24
<b>LMCC</b>	Cello C	174.57

<b>VIOLIN</b>	<b>WONDERTONE GOLD LABEL</b>	
P3151	E Steel (Ball End)	\$10.20B
P3158	E Steel (Loop End)	10.20B
P2162	A Gut/Aluminum	40.80B
P2163	D Gut/Aluminum	41.25B
P2164	G Gut/Silver	45.60B

<b>VIOLA</b>		
P2262	D Gut/Aluminum	\$52.65B

<b>CELLO</b>		
P2353	G Gut/Silver	\$103.65B
P2354	C Gut/Silver	131.25B

<b>VIOLIN</b>	<b>OLIV</b>	
P3118	E Loop Goldsteel	\$32.15B
P2113	D Gut/Aluminum-Silver	56.10B
P2114	G Gut/Gold-Silver	109.35B

<b>VIOLIN</b>	<b>TONICA</b>	
P4120	Complete Set	\$59.96B

<b>VIOLIN</b>	<b>OBLIGATO</b>	
P4110	Complete Set	\$178.20B

## MATHIAS THOMA

H9722	Violin, 4/4, 1/8, size	\$18.00 set
H9814	Viola	30.00 set
H9862	Cello	60.00 set
H9896	Bass	112.50 set

## BRETON

<b>VIOLIN</b>		
VNS149	3/4 - 4/4	\$14.65

PRICES MAY VARY DUE TO EURO/DOLLAR FLUCTUATION

# OBOE AND BASSOON REEDS



## EMERALD REEDS

Finest materials & top workmanship make this a truly excellent double reed.

<b>OBOE</b> .....		<b>\$13.35</b>
<b>EOS</b> .....	Soft	
<b>EOMS</b> .....	Med. Soft	
<b>EOM</b> .....	Medium	
<b>EOMH</b> .....	Med. Hard	
<b>EOH</b> .....	Hard	
<b>EAO</b> .....	Artist	<b>\$15.00</b>



<b>BASSOON</b> .....		<b>\$15.00</b>
<b>EBS</b> .....	Soft	
<b>EBMS</b> .....	Med. Soft	
<b>EBM</b> .....	Medium	
<b>EBMH</b> .....	Med. Hard	
<b>EBH</b> .....	Hard	
	(Wire Wound)	
<b>EAB</b> .....	Artist	<b>\$16.65</b>



## CHARTIER REEDS

Each and every reed is finished and adjusted by hand. Available in soft, medium soft, medium, medium hard, and hard. Wire wound.

<b>CHO</b> .....	Oboe (Traditional Scrape)	<b>\$13.50</b>
<b>CHB</b> .....	Bassoon	<b>\$13.80</b>

## LONG SCRAPE OBOE REEDS

<b>CHLONG</b> .....	Medium Soft, Medium, Medium Hard	<b>\$13.80</b>
<b>CHPRO</b> .....	Pro Oboe, Medium, Medium Hard, Medium Soft	<b>\$14.70</b>
<b>CHBLS</b> .....	Pro Bassoon, Medium, Medium Hard, Medium Soft	<b>\$13.80</b>



## MEASON REEDS

<b>OBOE</b> .....		<b>\$20.99</b>
<b>ME012</b> .....	Med. Soft	
<b>ME013</b> .....	Medium	
<b>ME014</b> .....	Med. Hard	

<b>BASSOON</b> .....		<b>\$20.99</b>
<b>MEB22</b> .....	Med. Soft	
<b>MEB23</b> .....	Medium	
<b>MEB24</b> .....	Med. Hard	
	(Wire Wound)	



## JONES REEDS

Jones Reed are carefully handcrafted from the finest French cane available. Available in medium soft, medium and medium hard.

<b>J101</b> .....	Oboe	<b>\$20.99</b>
<b>ARTO</b> .....	Artist Oboe	<b>\$24.99</b>
<b>J201</b> .....	Bassoon, wire wound	<b>\$20.99</b>
<b>ARTB</b> .....	Artist Bassoon	<b>\$24.99</b>
<b>J301</b> .....	English Horn (MS) (M) (MH)	<b>\$25.99</b>
<b>JA110</b> .....	Reed Soaker Cup	<b>\$13.99</b>

## REED CASES



### INJECTION MOLDED CASES

<b>EOP4</b> .....	Oboe, holds four reeds	<b>\$51.20</b>
<b>EOP12</b> .....	Oboe, holds twelve reeds	<b>\$79.20</b>
<b>RVCASE05</b> .....	Oboe/Bassoon (Rico)	<b>\$37.00</b>



## PLASTIC OBOE/BASSOON REEDS

<b>OBOE</b>		
<b>EOP</b> .....	Emerald, Medium, Soft, Hard	<b>\$17.85</b>
<b>CHOP</b> .....	Chartier, Medium, Med Soft, Med Hard	<b>\$15.00</b>

### BASSOON

<b>EBP</b> .....	Emerald, Soft, Medium, Hard, Wire Wound	<b>\$17.85</b>
<b>CHBP</b> .....	Chartier, Medium, Medium Soft, Medium Hard, Wire Wound	<b>\$15.00</b>

## REED MAKING SUPPLIES



<b>OBOE CANE</b>		
<b>OC</b> .....	Gouged and folded	<b>\$56.00</b>

### BASSOON CANE

<b>BCG</b> .....	Gouged only	<b>\$48.00/10</b>
<b>ORT</b> .....	Oboe Reed Tubes	<b>\$3.00</b>
<b>CPOP</b> .....	Pointed Oboe Plaque	<b>\$3.00</b>
<b>CROP</b> .....	Rounded Oboe Plaque	<b>\$3.00</b>
<b>CBP</b> .....	Bassoon Plaque	<b>\$3.00</b>
<b>ACC174A</b> .....	Oboe Wire	<b>\$23.20</b>
<b>ACC174B</b> .....	Red nylon thread	<b>\$19.40</b>

## OBOE REED TOOL KITS



Set of four Oboe Reed Tools in a fitted vinyl roll bag with pockets. Set consists of: Knife, Mandrel, Cutting-Block and Plaque.

<b>CO1000</b> .....	<b>\$160.00</b>
<b>COTK</b> .....	<b>\$108.00</b>

## BASSOON REED TOOL KIT

Set of five Bassoon Reed tools in a fitted vinyl roll bag with pockets. Set consists of Knife, Mandrel, Plaque and Cutting-Block.

<b>CF2000</b> .....	<b>\$198.00</b>
<b>CBTK</b> .....	<b>\$108.00</b>



## REED MAKING TOOLS



<b>OMAN</b> .....	Oboe Mandrel	<b>\$52.00</b>
<b>BMAN</b> .....	Bassoon Mandrel	<b>\$53.20</b>
<b>CPCB</b> .....	Cutting Block	<b>\$6.75</b>
<b>ACC180</b> .....	Reed Knife, Wood Handle	<b>\$78.00</b>
<b>ACC167</b> .....	Reed Knife, Straight	<b>\$60.00</b>
<b>CRHRK</b> .....	Reed Knife, Right Hand	<b>\$48.00</b>
<b>CLHRK</b> .....	Reed Knife, Left Hand	<b>\$48.00</b>
<b>CBFP</b> .....	Bassoon Forming Pliers	<b>\$66.00</b>

# SELMER



## OBOE REED CANE

(10 pieces cane per pack)

**S587** Gouged and folded.....**\$60.00B**

## SUPPLIES

**S516** Gold beaters "Fish" skin.....**\$29.35**

**S689** Wire (spool).....**\$1.45**



## DOUBLE REED REPLACEMENT PARTS

**S781** Bassoon hand rest (crutch) assembly.....**\$56.00**

**S782** Bassoon hand rest only.....**\$15.00**



## REED KNIFE

Precision-honed steel edge and balanced handle allow controlled adjustment of reed surface.

**S515** Reed knife.....**\$67.00**

## DOUBLE REED TOOL KITS

(includes: knife, mandrel, arrow shaped plaque, cutting block, tool pouch).

**S621** Bassoon (includes reamer).....**\$236.20**



## REED CASES

Wood shell construction, vinyl covered reed case. Beveled glass inside offers the optimal protection against reed warping and tip damage. Available for clarinet/alto saxophone, bass clarinet/tenor saxophone, and baritone saxophone.

**S7705** Clarinet/Alto Saxophone (holds 5 reeds).....**\$67.00**

**S7710** Clarinet/Alto Saxophone (holds 10 reeds).....**\$83.00**

**S8805** Bass Clarinet/Tenor Saxophone (holds 5 reeds).....**\$72.00**

**S8810** Bass Clarinet/Tenor Saxophone (holds 10 reeds).....**\$89.00**

**S9905** Baritone Saxophone (holds 5 reeds).....**\$83.00**

## REED KNIFE

Precision-honed steel edge and balanced handle allow controlled adjustment of reed surface.

**S515** Reed Knife.....**\$67.00**



## DOUBLE REED CASES

Plush lined, molded plastic case. Oboe case holds six reeds, bassoon case holds four.

**S513DR** Oboe reed case.....**\$47.20**

**S713** Bassoon reed case.....**\$2.45**



## BRILHART REED TRIMMER

An economy-priced reed trimmer with many of the features required by both amateur and professional musicians.

**SA227** Bb Clarinet.....**\$72.00**

**SA427A** Alto Saxophone.....**\$73.00**

**SA427T** Tenor Saxophone.....**\$80.00**

**SA427B** Baritone Saxophone.....**\$75.00**



## SELMER (USA) and SOLOIST REEDS

Selmer (USA) and Soloist reeds are made from the finest available imported cane. Fibercane oboe reeds are made from Dacron polyester resin filaments, eliminating many of the moisture and consistency problems commonly found in cane. Brillhart bassoon reeds are made of molded plastic to ensure consistency, reed after reed.

## OBOE REED

**S510MH**.....**\$22.00**

## ENGLISH HORN REEDS

**S603DR** Selmer Medium.....**\$27.00**

## BASSOON REEDS

**S705** Selmer (USA) - Medium.....**\$19.00**

**S707MH** Selmer (USA) - Medium Hard.....**\$16.95**

## REED SURFACER



Easily restore the table of any reed

**2431** Reed Rush 8 pc.....**\$6.00 pk.**

**R14** Runyon.....**\$14.55**

## VANDOREN



### ACCESSORIES

#### REED CASES

An elegantly designed reed case provides maximum protection and moisture control for your reeds.

**VRC810** ..... \$54.99  
Holds 8 of any Ab, Eb, Bb clarinet, soprano or soprano sax reeds.

**VRC620** ..... \$54.99  
Holds 6 alto sax reeds.

**VRCK** ..... \$12.99  
3 replacement desiccants and a sponge insert for the reed case.

#### HYGRO REED CASES

This reed case is designed to maintain your reeds in optimal humidity conditions to avoid any deterioration. It is based on: a regulated humidification by air circulation, a hygrometry level controlled by a humidity indicator disc.

**HRC10** ..... \$58.99  
Holds 6 of any Bb, Eb or alto clarinet and soprano or alto sax reeds.

**HRC20** ..... \$58.99  
Holds 6 of any bass clarinet and tenor or baritone sax reeds.

**HRCK** ..... \$10.99  
Contains two replacement humidity indicator discs and a sponge.

#### REED RESURFACER

**RR100** ..... \$5.50  
Mild abrasive returns reed table to flat surface, prolonging reed life.

**RR200** Kit ..... \$111.99

## RICO



Simply place your reeds inside the case. Reed Vitalizer will regulate the humidity inside the case keeping your reeds flat and preventing cracking. **Fits all reeds from Eb Clarinet to Baritone Sax.**

**RVCASE04** ..... \$37.00

#### DOUBLE REED CASE

The newest member of the reed case family, Rico's double reed case is designed to hold 5 oboe or 5 bassoon reeds in any combination. Specially designed pegs securely hold Oboe, Oboe D'Amour, English Horn, and Bassoon reeds. The case is designed to work with Rico's Reed Vitalizer 2-way Humidity control system.

**RVCASE05** Oboe/Bassoon Reed Case w/RV0173 ..... \$37.00

#### REED VITALIZER

Rico's Reed Vitalizer has made life a lot easier for woodwind players. The special Reed Vitalizer bag and Humidity Control Pack self-regulate the humidity level, keeping reeds in shape and consistent. Reed Vitalizer is available in three humidity levels (58%, 73%, 84%).

**RVKIT58** 58% Humidity ..... \$16.50

**RVKIT73** 73% Humidity ..... 16.50

**RVKIT84** 84% Humidity ..... 16.50

**RV0158, 73, or 84** 1 Pack Refill ..... 9.25

## REED CARDS

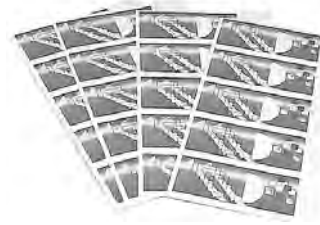

Card is made of heavy duty board, lacquered to resist moisture, and to hold its shape. It is die cut to the contour of reeds on the inside, and glued 1/32" in strips. Each card holds 6 reeds. Insert for reed is printed in red as a guideline. Reed tip will not split on the top of card.

**1566** Card holds 6 reeds ..... \$20.00/50

## RICO REED GUARDS

Holds 2 reeds

**RG2CLAS** Clarinet/Alto Sax ..... \$5.75/2 pk.

**RG2TSBS** Tenor/Bari Sax ..... 6.75/2 pk.

**RG20B** Oboe ..... 8.75/2 pk.

Holds 4 reeds

**RG4CLAS** Clarinet/Alto Sax ..... \$7.50

**RG4TSBS** Tenor/Bari Sax ..... 7.50

## REED CASES



#### HODGE

**HORC3** Oboe, Holds 3 ..... \$14.00

**HBRC3** Bassoon, Holds 3 ..... 14.00

**HASCRC** A Sax, Clarinet Holds 6 ..... 19.50

Silk & Leather, and Maplewood cases are available.

#### VITO REED GUARDS

**2434** Clarinet ..... \$3.68

**2438** Alto Sax, Alto Clarinet ..... 3.68

**2439** Tenor Sax, Bass Clarinet ..... 3.68

#### PLAYERS

**REEDGR2** Clarinet/Alto Sax (2) ..... \$2.25

**REEDGR4** Clarinet/Alto Sax (4) ..... 3.25

## REED TRIMMERS



The reed trimmer is adjustable to adapt to all brands of reeds on the market. Innovative design and extremely close manufacturing tolerances make it possible to trim as little as 2 or 3 thousandths of an inch off even a wet reed.

#### CORDIER

**7276** Clarinet ..... \$88.75

**7277** Soprano Sax ..... 88.75

**7278** Alto Sax ..... 95.95

**7279** Tenor Sax ..... 95.95

**7280** Bari Sax ..... 103.15

#### RIGOTTI

**TA111** Clarinet ..... \$72.00

**TA112** Alto Sax ..... 84.00

**TA113** Tenor Sax ..... 84.00

## BARI REEDS

### BARI ORIGINAL SYNTHETIC REEDS

Brilliant and vibrant sound. Great projection and focus. Immediate response. Graded in soft, medium and hard for Bb and bass clarinet, soprano, alto, tenor and baritone saxophone. Strengths: Soft (2.0-2.5), Medium Soft (2.5-3.0), Medium (3.0-3.5), Medium Hard (3.5-4.0), Hard (4.0-4.5)

<b>CLBARI</b>	Clarinet.....	<b>\$18.00</b>
<b>ASBARI</b>	Alto Sax.....	<b>18.00</b>
<b>TSBARI</b>	Tenor Sax.....	<b>18.00</b>
<b>BCBARI</b>	Bass Clarinet.....	<b>18.00</b>
<b>SSBARI</b>	Soprano Sax.....	<b>18.00</b>
<b>BSBARI</b>	Baritone Sax.....	<b>18.00</b>



### BARI STAR SERIES

Warmer, darker sound. Rounded tone. Consistent response. Graded in soft, medium and hard for Bb and bass clarinet, soprano, alto, tenor and baritone saxophone. Strengths: Soft (2.0-2.5), Medium Soft (2.5-3.0), Medium (3.0-3.5), Medium Hard (3.5-4.0), Hard (4.0-4.5)

<b>CLSTAR</b>	Clarinet.....	<b>\$18.00</b>
<b>ASSTAR</b>	Alto Sax.....	<b>18.00</b>
<b>TSSTAR</b>	Tenor Sax.....	<b>18.00</b>
<b>BCSTAR</b>	Bass Clarinet.....	<b>18.00</b>
<b>SSSTAR</b>	Soprano Sax.....	<b>18.00</b>
<b>BSSTAR</b>	Baritone Sax.....	<b>18.00</b>

## AVANT REEDS



Synthetic Reed. Available in soft, medium and hard strengths.

<b>AVC</b>	Clarinet.....	<b>\$12.75</b>
<b>AVAS</b>	Alto Sax.....	<b>12.75</b>
<b>AVSS</b>	Soprano Sax.....	<b>12.75</b>
<b>AVTS</b>	Tenor Sax.....	<b>12.75</b>

Specify Strength & Instrument, i.e. AVMAS = Medium Alto Sax

## EMERALD REEDS

Synthetic Reed. Available in soft, medium and hard strengths.

<b>EMC</b>	Clarinet.....	<b>\$13.35</b>
<b>EMAS</b>	Alto Sax.....	<b>13.35</b>
<b>EMTS</b>	Tenor Sax.....	<b>13.35</b>

Specify Strength & Instrument, i.e. EMMC = Medium Clarinet

## PREMIER FIBRACELL REEDS



Fibracell offers a cross-sectional fiber and cell structure patterned after natural cane. (i.e., to order CLMIRI #2, specify CLMIRI2)

<b>CLMIRI</b>	Premier Clarinet.....	<b>\$20.00</b>
<b>ASMIRI</b>	Premier Alto Sax.....	<b>21.25</b>
<b>TSMIRI</b>	Premier Tenor Sax.....	<b>22.25</b>
<b>SSMIRI</b>	Premier Soprano Sax.....	<b>20.00</b>
<b>BCMIRI</b>	Premier Bass Clarinet.....	<b>22.25</b>
<b>BSMIRI</b>	Premier Bari Sax.....	<b>25.75</b>

## LEGERE REEDS



Synthetic Reed. Specify Strength

<b>LECL</b>	Clarinet.....	<b>\$27.77B</b>
<b>LEEC</b>	Eb Clarinet.....	<b>27.77B</b>
<b>LECLQC</b>	Clarinet, Quebec Cut.....	<b>27.77B</b>
<b>LECLOC</b>	Clarinet, Ontario Cut.....	<b>27.77B</b>
<b>LEBCL</b>	Bass Clarinet.....	<b>27.77B</b>
<b>LECBCL</b>	Contra Bass Clarinet.....	<b>27.77B</b>
<b>LEBBS</b>	Bass Sax.....	<b>27.77B</b>
<b>LEASSC</b>	Alto Sax, Studio Cut.....	<b>27.77B</b>
<b>LETSSC</b>	Tenor Sax, Studio Cut.....	<b>27.77B</b>
<b>LEAS</b>	Alto Sax.....	<b>27.77B</b>
<b>LETS</b>	Tenor Sax.....	<b>27.77B</b>
<b>LESS</b>	Soprano Sax.....	<b>27.77B</b>
<b>LEBS</b>	Baritone Sax.....	<b>27.77B</b>
<b>LECLS</b>	Clarinet, Signature.....	<b>37.39B</b>
<b>LEBCS</b>	Bass Clarinet, Signature.....	<b>37.39B</b>
<b>LEASS</b>	Alto Sax, Signature.....	<b>37.39B</b>
<b>LETSS</b>	Tenor Sax, Signature.....	<b>37.39B</b>
<b>LESSS</b>	Soprano Sax, Signature.....	<b>37.39B</b>

## RICO REEDS



### 25 Reed to a Box Instrument

<b>RIEC</b>	Eb Clarinet.....	<b>\$82.50</b>
<b>RICL</b>	Bb Clarinet.....	<b>71.00</b>
<b>RIBC</b>	Bass Clarinet.....	<b>133.25</b>
<b>RISS</b>	Soprano Saxophone.....	<b>101.00</b>
<b>RIAS</b>	Alto Saxophone.....	<b>107.50</b>
<b>RITS</b>	Tenor Saxophone.....	<b>142.50</b>
<b>RIBS</b>	Baritone Saxophone.....	<b>179.25</b>
<b>RDA5025</b>	Display Rack.....	<b>22.50</b>

To Order RICO ALTO SAX 2, Specify RIAS2

### 10 Reed to a Box Instrument

<b>10RICL</b>	Bb Clarinet.....	<b>\$30.50</b>
<b>10RIBC</b>	Bass Clarinet.....	<b>53.50</b>
<b>10RISS</b>	Soprano Saxophone.....	<b>40.50</b>
<b>10RIAS</b>	Alto Saxophone.....	<b>43.25</b>
<b>10RITS</b>	Tenor Saxophone.....	<b>57.75</b>
<b>10RIBS</b>	Bari Saxophone.....	<b>74.25</b>
<b>10RICB</b>	Contra Alto/Contra Bass Clarinet/Bass Sax.....	<b>88.75</b>
<b>RDA10S</b>	Display Rack.....	<b>22.50</b>

### 3 Pack Instrument

<b>3RICL</b>	Clarinet.....	<b>\$10.00</b>
<b>3RISS</b>	Soprano Sax.....	<b>12.75</b>
<b>3RIAS</b>	Alto Sax.....	<b>13.75</b>
<b>3RIAC</b>	Alto Clarinet.....	<b>13.75</b>
<b>3RIBC</b>	Bass Clarinet.....	<b>16.25</b>
<b>3RITS</b>	Tenor Sax.....	<b>17.77</b>
<b>3RIBS</b>	Bari Sax.....	<b>22.50</b>

### Reserve 5 per Box Instrument

<b>RESCL</b>	Bb Clarinet, 10 per box.....	<b>\$45.25</b>
<b>RESTS</b>	Tenor Sax.....	<b>36.50</b>
<b>RESSS</b>	Soprano Sax.....	<b>27.50</b>
<b>RESBC</b>	Bass Clarinet.....	<b>42.50</b>
<b>RESBS</b>	Bari Sax.....	<b>58.25</b>

## RICO ROYAL REEDS



### Instrument - 10 per box

<b>ROAC</b>	Alto Clarinet.....	<b>\$46.75</b>
<b>ROCL</b>	Bb Clarinet.....	<b>32.50</b>
<b>ROEC</b>	Eb Clarinet.....	<b>33.75</b>
<b>ROBC</b>	Bass Clarinet.....	<b>60.50</b>
<b>ROAS</b>	Alto Saxophone.....	<b>46.75</b>
<b>ROTS</b>	Tenor Saxophone.....	<b>64.50</b>
<b>ROBS</b>	Baritone Saxophone.....	<b>83.00</b>
<b>ROSS</b>	Soprano Saxophone.....	<b>42.25</b>

i.e. To order Royal Clarinet #2, Specify ROCL2

### 3 PACK

<b>3ROCL</b>	Clarinet.....	<b>\$10.50</b>
<b>3ROAS</b>	Alto Sax.....	<b>15.00</b>
<b>3ROTS</b>	Tenor Sax.....	<b>20.25</b>

## RICO PLASTICOVER



### Instrument - 5 per box

<b>PLCL</b>	Bb Clarinet.....	<b>\$29.00</b>
<b>PLSS</b>	Soprano Saxophone.....	<b>33.00</b>
<b>PLAS</b>	Alto Saxophone.....	<b>35.75</b>
<b>PLTS</b>	Tenor Saxophone.....	<b>45.75</b>
<b>PLBS</b>	Baritone Saxophone.....	<b>53.25</b>

Specify Strength

[www.ricoreeds.com](http://www.ricoreeds.com)

PRICES SUBJECT TO CHANGE WITHOUT NOTICE



## FREDERICK L. HEMKE REEDS



<b>Premium Reed</b>	<b>5 per box</b>
<b>FHAS</b> Alto Saxophone.....	<b>\$23.50</b>
<b>FHTS</b> Tenor Saxophone.....	<b>33.75</b>
<b>FHBS</b> Baritone Saxophone.....	<b>60.00</b>
<b>FHSS</b> Soprano Saxophone.....	<b>21.50</b>

## MITCHELL LURIE REEDS



<b>Premium Reed</b>	<b>5 per box</b>
<b>MLPCL</b> Bb Clarinet.....	<b>\$18.50</b>

<b>Original Cut Reed</b>	<b>10 per box</b>
<b>MLOCL</b> Bb Clarinet.....	<b>\$33.75</b>

## FLAVOR REEDS

Available in: (BG) Bubblegum, (OR) Orange, (BR) Raspberry, (CM) Cinamon, (CR) Cherry, (GR) Grape, (MG) Mint, (PC) Pina Colada, (SB) Strawberry, (WM) Watermelon.

<b>CL</b> Clarinet.....	<b>\$3.95B/2</b>
<b>AS</b> Alto Sax.....	<b>5.50B/2</b>
<b>TS</b> Tenor Sax.....	<b>11.50B/2</b>

(IE: CLCR2.0 = Cherry Clarinet #2)

## NARRAGANSETT REEDS



Quality cane reeds, pack of 5 per box.

<b>NCR</b> Clarinet.....	<b>\$9.45B/2</b>
<b>NAS</b> Alto Sax.....	<b>12.30B/2</b>

1 1/2 Thru 3 Strengths

## RICO RESERVE CLASSIC REEDS



<b>CLACL</b> Bb Clarinet.....	<b>10 per box</b>
<b>RCAS</b> Alto Sax.....	<b>\$53.00</b>

## TASTEE REED



Liquid flavoring for reeds. Simply dip reed in jar.

<b>TTRS</b> Spearmint.....	<b>\$9.95</b>
<b>TTRBG</b> Bubble Gum.....	<b>9.95</b>

## GRAND CONCERT REEDS



The Grand Concert Select family of reeds features more material in the heart for a pure, warm, transparent tone quality, stable and consistent from pianissimo to fortissimo, in all registers.

<b>GCRCL</b> Bb Clarinet Regular.....	<b>\$41.50</b>
<b>GCTCL</b> Bb Clarinet Thick Blank.....	<b>48.50</b>
<b>GCBC</b> Bass Clarinet (5 per box).....	<b>32.25</b>
<b>GCECL</b> Evolution Clarinet.....	<b>48.50</b>
<b>GCAS</b> Alto Sax.....	<b>49.50</b>
<b>GCTS</b> Tenor Sax (5 per box).....	<b>34.00</b>
<b>GCSS</b> Soprano Sax.....	<b>40.00</b>

## LA VOZ REEDS



Crafted from premium cane for consistent response and playability, La Voz is the choice of professional saxophone and clarinet players. Unfiled for a deep, powerful tone, La Voz is the reed of choice for many of the world's top jazz musicians. Specify: Soft, Medium Soft, Medium, Medium Hard, Hard.

	<b>10 per box</b>
<b>LCL</b> Bb Clarinet.....	<b>\$32.50</b>
<b>LAS</b> Alto Saxophone.....	<b>46.75</b>
<b>LTS</b> Tenor Saxophone.....	<b>61.25</b>
<b>LBS</b> Baritone Saxophone.....	<b>83.00</b>
<b>LBC</b> Bass Clarinet.....	<b>58.25</b>
<b>LSS</b> Soprano Saxophone.....	<b>42.25</b>

## ZONDA REEDS



Premium quality cane reeds. Packed 5 reeds per box.

<b>ZC</b> Supreme Bb Clarinet.....	<b>\$20.95</b>
i.e., to order ZC10(20) = #2, (25 = 2 1/2), (30 = 3) Strength	
<b>ZC</b> Classico Bb Clarinet (10 per box).....	<b>26.95</b>
i.e., to order ZC30(20) = #2, (25 = 2 1/2), (30 = 3) Strength	
<b>ZC</b> Supreme Bass Clarinet.....	<b>31.95</b>
i.e., to order ZC12(20) = #2, (25 = 2 1/2), (30 = 3) Strength	
<b>ZS</b> Supreme Soprano Sax.....	<b>20.95</b>
i.e., to order ZS20(20) = #2, (25 = 2 1/2), (30 = 3) Strength	
<b>ZS</b> Supreme Alto Sax.....	<b>23.95</b>
i.e., to order ZS21(20) = #2, (25 = 2 1/2), (30 = 3) Strength	
<b>ZS</b> Supreme Tenor Sax.....	<b>28.95</b>
i.e., to order ZS22(20) = #2, (25 = 2 1/2), (30 = 3) Strength	
<b>ZS</b> Supreme Baritone Sax.....	<b>50.95</b>
i.e., to order ZS24(20) = #2, (25 = 2 1/2), (30 = 3) Strength	

**Note: All reeds come in 20, 25, 30, 35 strengths. Also only Clarinet, Classico Clarinet and Alto Sax come in 4 strengths.**

## RICO JAZZ SELECT REEDS



The Rico Jazz reed is for professional players, featuring elite raw materials, precise response and consistency, and with an all new strength grading system, specifically designed to meet topnotch players' definitions of ideal playability. The reeds are available filed and unfiled, 2 through 4 in soft, medium and hard substrengths with an additional single strength in 5. N/A in 1/2 strengths.

<b>RUAS</b> Alto Sax, unfiled (10).....	<b>\$49.50</b>
<b>RUTS</b> Tenor Sax, unfiled (5).....	<b>35.25</b>
<b>RUBS</b> Bari Sax, unfiled (5).....	<b>63.50</b>
<b>RUSS</b> Soprano Sax, unfiled (10).....	<b>45.00</b>
<b>RFAS</b> Alto Sax, filed (10).....	<b>49.50</b>
<b>RFTS</b> Tenor Sax, filed (5).....	<b>35.25</b>
<b>RFBS</b> Bari Sax, filed (5).....	<b>63.25</b>
<b>RFSS</b> Soprano Sax, filed (10).....	<b>45.00</b>

# VANDOREN REEDS



## CLARINET REEDS

	Boxes of 10						Boxes of 5			
	TRADITIONAL	TRADITIONAL	V*12	German	Black Master	56 Rue Lepic	TRADITIONAL	TRADITIONAL	V*12	Vandoren
	EB	Bb					ALTO	BASS	BASS CLARINET	1 pk Reeds
1		VCL1								
1 1/2	VEC1 1/2	VCL1 1/2					VAC1 1/2	VBC1 1/2		
2	VEC2	VCL2		VGC2			VAC2	VBC2		ONEVAS2
2 1/2	VEC2 1/2	VCL2 1/2	CR1925	VGC2 1/2	CR1825	CR5025	VAC2 1/2	VBC2 1/2	CR6225	ONEVAS2 1/2
3	VEC3	VCL3	CR193	VGC3	CR183	CR503	VAC3	VBC3	CR623	ONEVAS3
3 1/2	VEC3 1/2	VCL3 1/2	CR1935	VGC3 1/2	CR1835	CR5035 CR5035+	VAC3 1/2	VBC3 1/2	CR6235	
4	VEC4	VCL4	CR194	VGC4	CR184	CR504	VAC4	VBC4	CR624	
4 1/2			CR1945						CR6245	
5		VCL5	CR195	VGC5		CR505				Vandoren 1 pk Reeds \$4.44
5+			CR196				Contra BASS \$94.95			
							VCBC2 2			ONEVCL2
							VCBC3 3			ONEVCL2 1/2
							VCBC4 4			ONEVCL3

## SAXOPHONE REEDS

	Boxes of 10								Boxes of 5									
	Soprano				Alto				Tenor				Baritone					
	V16	ZZ	Traditional	V12	JAVA RED	JAVA	V16	ZZ	JAVA RED	Traditional	V12	JAVA	V16	ZZ	Traditional	ZZ	JAVA	JAVA RED
1																		
1 1/2																		
2	SR712	SR402																
2 1/2	SR7125	SR4025																
3	SR713	SR403																
3 1/2	SR7135	SR4035																
4	SR714	SR404																
5																		

(Bass Sax, VBBS2, 3, 4.....\$92.99)

### Boxes of 10

	Soprano			
	TRADITIONAL	TRADITIONAL	JAVA	V12
1				
1 1/2				
2	VNS2	VSS2	JSS2	
2 1/2		VSS2 1/2	JSS2 1/2	SR6025
3	VNS3	VSS3	JSS3	SR603
3 1/2		VSS3 1/2	JSS3 1/2	SR6035
4	VNS4	VSS4	JSS4	SR604
5				SR605

**SOPRANO JAVA RED**  
SR30#R.....\$42.99

### JAZZ REED MIX PACKS

SRMIXA2	Alto Sax Reed Mix #2	\$22.99
SRMIXA25	Alto Sax Reed Mix #2.5	\$22.99
SRMIXA3	Alto Sax Reed Mix #3	\$22.99
SRMIXA35	Alto Sax Reed Mix #3.5	\$22.99
SRMIXT2	Tenor Sax Reed Mix #2	\$31.99
SRMIXT25	Tenor Sax Reed Mix #2.5	\$31.99
SRMIXT3	Tenor Sax Reed Mix #3	\$31.99
SRMIXT35	Tenor Sax Reed Mix #3.5	\$31.99
SRMIXS25	Jazz Reed Mix - Sop Sax #2.5	\$18.99
SRMIXS3	Jazz Reed Mix - Sop Sax #3	\$18.99
SRMIXS35	Jazz Reed Mix - Sop Sax #3.5	\$18.99
SRMIXB25	Jazz Reed Mix - Bari Sax #2.5	\$59.99
SRMIXB3	Jazz Reed Mix - Bari Sax #3	\$59.99
SRMIXB35	Jazz Reed Mix - Bari Sax #3.5	\$59.99

Each card contains one each of a V16, Java Red, Java (Green), and ZZ

### Bulk Packs (50/box)

#### CLARINET

CR102/50	Bb Clarinet Traditional #2	\$216.99
CR1025/50	Bb Clarinet Traditional #2.5	\$216.99
CR103/50	Bb Clarinet Traditional #3	\$216.99
CR1035/50	Bb Clarinet Traditional #3.5	\$216.99

#### V12

CR1925/50	Bb Clarinet V12 #2.5	\$281.99
CR193/50	Bb Clarinet V12 #3	\$281.99
CR1935/50	Bb Clarinet V12 #3.5	\$281.99

#### 56 RUE LEPIC BULK

CR5025/50	Bb Clarinet 56 Rue Lepic #2.5	\$281.99
CR503/50	Bb Clarinet 56 Rue Lepic #3	\$281.99

#### ALTO SAX

SR212/50	Alto Sax Traditional #2	\$272.99
SR2125/50	Alto Sax Traditional #2.5	\$272.99
SR213/50	Alto Sax Traditional #3	\$272.99
SR2135/50	Alto Sax Traditional #3.5	\$272.99

#### V12

SR6125/50	Alto Sax V12 Reed #2.5	\$314.99
SR613/50	Alto Sax V12 Reed #3	\$314.99

#### JAVA

SR262/50	Alto Sax Java #2	\$272.99
SR2625/50	Alto Sax Java #2.5	\$272.99
SR263/50	Alto Sax Java #3	\$272.99
SR2635/50	Alto Sax Java #3.5	\$272.99

#### JAVA RED

SR262R/50	Alto Sax Java Red Cut #2	\$272.99
SR2625R/50	Alto Sax Java Red Cut #2.5	\$272.99
SR263R/50	Alto Sax Java Red Cut #3	\$272.99

#### V16

SR702/50	Alto Sax V16 #2	\$272.99
SR7025/50	Alto Sax V16 #2.5	\$272.99
SR703/50	Alto Sax V16 #3	\$272.99

#### ZZ

SR412/50	Alto Sax ZZ #2	\$272.99
SR4125/50	Alto Sax ZZ #2.5	\$272.99
SR413/50	Alto Sax ZZ #3	\$272.99



# VANDOREN MOUTHPIECES

## Saxophone Mouthpieces

### V5 SERIES

<b>SOPRANO</b> .....	<b>\$214.99</b>
S15.....	SM401
■ S25.....	SM402
S27.....	SM404
■ S35.....	SM403

<b>ALTO</b> .....	<b>\$232.99</b>
A15.....	SM411
A17.....	SM418
A20.....	SM412
■ A25.....	SM413
A27.....	SM414
■ A28.....	SM419
A35.....	SM415
A45.....	SM416
A55.....	SM417

<b>TENOR</b> .....	<b>\$259.99</b>
■ T15.....	SM421
T20.....	SM422
T25.....	SM423
T75.....	SM613
T95.....	SM614
T97.....	SM615
T35.....	SM424

### ● Optimum Mouthpieces

<b>ALTO</b> .....	<b>\$232.99</b>
AL3.....	SM711
AL4.....	SM712
AL5.....	SM713

<b>TENOR</b> .....	<b>\$259.99</b>
TL3.....	SM721
TL4.....	SM722

### JAVA SERIES

<b>ALTO</b> .....	<b>\$232.99</b>
A35.....	SM501
■ A45.....	SM502
A55.....	SM503
A75.....	SM504
A95.....	SM505

<b>TENOR</b> .....	<b>\$259.99</b>
T45.....	SM511
T55.....	SM512
T75.....	SM513
T95.....	SM514
T97.....	SM515

### JUMBO JAVA SERIES

<b>ALTO</b> .....	<b>\$232.99</b>
■ A45.....	SM602
A55.....	SM603
A75.....	SM604
A95.....	SM605

<b>TENOR</b> .....	<b>\$259.99</b>
■ T45.....	SM611
T55.....	SM612
T75.....	SM613
T95.....	SM614
T97.....	SM615



<b>BARITONE</b> .....	<b>\$467.99</b>
■ B25.....	SM431
B27.....	SM435
B35.....	SM432
B75.....	SM433
B95.....	SM434



## V Ebonite 16 Mouthpieces

<b>ALTO</b> .....	<b>\$232.99</b>
	<b>Small Medium</b>
A5.....	SM811S SM811M
A6.....	SM812S SM812M
A7.....	SM813MC SM813M

## V Ebonite 16 Mouthpieces

<b>TENOR</b> .....	<b>\$259.99</b>
T7.....	SM823E
T8.....	SM824E
T9.....	SM825E
T10.....	SM826E

## V Metal 16 Mouthpiece

<b>TENOR</b> .....	<b>\$674.99</b>
T45.....	SM821
T55.....	SM822
■ T75.....	SM823
T77.....	SM824
T95.....	SM825



## Clarinet Mouthpieces

	<b>Bb</b>	<b>Profile 88</b>
	<b>\$172.99</b>	<b>\$172.99</b>
■ 5RV.....	CM301	CM3018
■ 5RV#.....	CM302	CM3028
11•6.....	CM305	CM3058
B46.....	CM306	CM3068
B40.....	CM307	CM3078
M30.....		CM3188
■ B45.....	CM308	CM3088
B45•.....	CM309	CM3098
5JB.....	CM310	CM3108
2RV.....	CM311	CM3118
B40#.....	CM319	CM3198
M15.....	CM317	CM3178
M30.....	CM318	
M30#.....	CM3001	CM30018



### ● 13 Series Bb

<b>PROFILE 88</b> .....	<b>\$184.99</b>	<b>Profile 88</b> .....	<b>\$184.99</b>
M13.....	CM4138	M30.....	CM40018
B40#.....	CM4198	M13#.....	CM4158
M13#.....	CM4158	■ M15.....	CM4178
■ M15.....	CM4178	■ M3013.....	CM4188
■ M3013.....	CM4188	M30#.....	CM40018
M30#.....	CM40018		

<b>Eb</b> .....	<b>\$172.99</b>
5RV.....	CM321
B44.....	CM322

<b>Bass</b> .....	<b>\$299.99</b>
■ B44.....	CM342
■ B45.....	CM344
■ B46.....	CM345

# MOUTHPIECES

## PORTNOY



- PNC** Clarinet, BP1, BP02, BP3 .....\$124.00  
**PNAC** Alto Clarinet, BP2 .....162.00  
**PNBC** Bass Clarinet, BP2 .....162.00

## MOUTHPIECE KITS



Kits include mouthpiece, cap and ligature.

- Y44** Clarinet.....\$17.35  
**Y46** Alto Sax.....19.60  
**Y48** Tenor Sax.....20.65  
**Y50** Baritone Sax.....57.75  
**Y52** Soprano Sax.....41.55  
**Y54** Bass Clarinet.....57.75

### MOUTHPIECES ONLY

- Y24** Clarinet.....\$9.50  
**Y26** Alto Sax.....9.90  
**Y28** Tenor Sax.....10.95  
**Y30** Baritone Sax.....46.50  
**Y32** Soprano Sax.....37.95  
**Y34** Bass Clarinet.....46.50  
**B11** C Melody Sax.....30.30

## DAVID HITE



### PREMIERE

- DH111** Bb clarinet (1.09 mm) .....\$33.50  
**DH117** Alto saxophone (1.78 mm) .....39.00  
**DH118** Tenor saxophone (2.41 mm) .....46.35  
**DH711** Clarinet ligature .....20.00  
**DH121D** Bb clarinet (1.04 mm) .....123.60  
**DH121J** Bb clarinet (1.14 mm) .....123.60  
**DH121M41** Bb clarinet (1.02 mm) .....123.60  
**DH120** Eb clarinet (1.04 mm).....128.75

### J & D HITE (with ligature and cap)

- DH123** Alto clarinet (1.45 mm) .....\$128.75  
**DH124** Bass clarinet (1.78 mm).....133.90  
**DH126** Soprano sax (1.19 mm) .....128.75  
**DH127** Alto sax, streamlined (1.83 mm)..129.75  
**DH128** Tenor sax, streamlined (2.41 mm) 133.90  
**DH129** Baritone sax, streamlined (2.54 mm)139.00  
**DH137M68** Alto sax, streamlined (1.68 mm)..129.75  
**DH717** Alto sax ligature (1.68 mm) .....20.00

## VITO II MOUTHPIECES



- 2533P2V** Bass Clarinet.....\$52.00  
**2533P2VK** Bass Clarinet Kit.....64.00  
**2540P** Bb Clarinet.....29.00  
**2540PK** Bb Clarinet Kit .....35.00  
**2544P** Alto Sax.....33.00  
**2544PK** Alto Sax Kit .....44.00  
**2545P** Tenor Sax .....41.00  
**2545PK** Tenor Sax Kit.....45.10

## AMPLATE



MADE IN USA  
 Mouthpiece, Cap & Ligature

- 2331K** Soprano Sax .....\$36.60  
**2332K** Clarinet .....20.10  
**2334K** Alto Sax .....21.30  
**2336K** Tenor Sax .....23.25  
**2337K** Bari Sax .....59.55  
**2531K** Bass Clarinet .....59.55
- Mouthpieces  
**2332M** Clarinet.....\$13.50  
**2334M** Alto Sax .....13.85  
**2336M** Tenor Sax .....14.70  
**2337M** Bari Sax .....50.60

## BELMONTE



- 5670** Bb clarinet.....\$16.75  
**5671** Eb alto sax.....18.90  
**5672** Bb tenor sax .....21.15

## RUNYON



### SYNTHETIC MOUTHPIECES

#### CUSTOM

(Available in black or red)

- CUAS** Alto Sax - Jazz .....\$108.35  
**CUTS** Tenor Sax .....117.15  
**CUBS** Bari Sax .....131.80

#### 88 SERIES WITH CAP AND LIGATURE

- RUCL** Bb Clarinet .....\$71.80  
**RUAS** Eb Alto Sax.....87.85  
**RUTS** Bb Tenor Sax.....98.10  
**RUBS** Baritone Sax .....94.50  
**RCBCL** Contra Bass .....76.25

#### SPOILER SERIES

- SPAS** Eb Alto Sax (Jazz) .....\$136.20  
**SPTS** Bb Tenor Sax .....143.50  
**SPSS** Bb Soprano Sax.....131.80  
**SPBS** Eb Baritone Sax .....153.75

#### BIONIX JAZZ SAX

- 6BIONIXAS** Alto .....\$145.00

#### METAL MOUTHPIECES

- CUMAS** Alto Sax, Custom .....\$212.95  
**CUMTS** Tenor Sax, Custom .....215.25  
**SPMAS** Alto Sax Spoiler.....234.25  
**SPMTS** Tenor Sax, Spoiler .....257.65

#### PLASTIC LIGATURES

- RASL** Alto Sax.....\$6.10  
**RTSL** Tenor Sax .....6.10  
**RBSL** Bari Sax .....6.10

#### FREEDOM ADJUSTABLE CLARINET BARREL

Manufactured in the heart of the United States. Is ideal for both large and medium bore clarinets. Made from aluminium alloy, it has an infinite adjustable range below 60mm – above 70mm.

- FACB01** .....\$95.00B

## ROVNER™

#### RECTANGULAR BORE CLARINET BARREL

Available in Sizes 64, 65 and 66 for assisting in achieving the best possible tuning.

- SRB**.....\$99.96

MOUTHPIECES ARE AVAILABLE IN ALL POPULAR FACINGS

## BOBBY DUKOFF



**"D" CHAMBER** The baffle in the chamber is built high enough for a bright "edgy" sound. **"M" SUPER CHAMBER** is slightly darker. **"X" Chamber** **"S" SUPER POWER CHAMBER** is a smaller chamber. **"LD" SUPER POWER CHAMBER** (original large chamber). **"S"** and **"LD"**, Tenor Sax only.

#### SILVERITE METAL

- MSS** Soprano Sax .....\$239.40B  
**MAS** Alto Sax.....256.85B  
**MTS** Tenor Sax .....256.85B  
**HWMTS** Hollywood Tenor Sax .....256.85B  
**MBS** Bari Sax .....313.60B

#### PERSONAL

- PMAS** Alto Sax .....\$398.95B  
**PMTS** Tenor Sax .....398.95B

#### LIGATURES/CAP

- VFLIG** Vibra Free Ligature.....\$33.75B  
**DLIG** Tenor Sax, metal mpc .....13.20B  
**DTCAP** Tenor Sax Cap .....8.25B  
**SSLIG** Soprano Sax Lig .....11.15B

## GUY HAWKINS



#### METAL:

- HMAS** Alto Sax.....\$218.00B  
**HMTS** Tenor Sax .....231.00B

#### HARD RUBBER:

- HRAS** Alto Sax .....\$98.00B

## RICO RESERVE MOUTHPIECES

- MCRX0** 1.0 .....\$190.00  
**MCRX5** 1.05 .....190.00  
**MCRX10** 1.10 .....190.00

## RICO ROYAL



#### GRAFTONITE

- RSS** Soprano Sax.....\$30.00  
**RCL** Clarinet .....33.00  
**RAS** Alto Sax.....33.00  
**RTS** Tenor Sax .....34.00  
**RBS** Baritone Sax .....36.00

(B3, B5, B7)



#### METALITE

- MJM** Alto Sax.....\$45.00  
**MIM** Soprano Sax.....45.00  
**MKM** Tenor Sax .....45.00  
**MLM** Bari Sax .....47.00

(M5, M7, M9)

(i.e., to order M5 Specify MIM5)

# MOUTHPIECES

## BERG LARSEN



### STAINLESS STEEL\*

MAS	Alto Sax.....	\$305.05B
MTS	Tenor Sax.....	\$327.80B
MBS	Bari Sax.....	\$438.90B

### EBONITE

RAS	Alto Sax.....	\$266.70B
RTS	Tenor Sax.....	\$283.35B
RBS	Bari Sax.....	\$388.90B
RSS	Soprano Sax.....	\$238.90B

Odd facings carry higher prices

### LIGATURES

#### Ebonite Mouthpieces

RSLIG	Soprano Sax.....	\$38.90B
RATLIG	Clar. Alto, Tenor Sax.....	\$38.90B
RBLIG	Bari Sax.....	\$38.90B

### LIGATURES

#### Metal Mouthpieces

MALIG	Alto Sax.....	\$38.90B
SLIG	Tenor (0 & 1 Chamber).....	\$38.90B
MTLIG	Tenor (2 & 3 Chamber).....	\$38.90B
MBLIG	Bari Sax.....	\$38.90B

### CAPS

#### Metal Mouthpieces

MATCAP	Alto, Tenor Sax.....	\$38.90B
--------	----------------------	----------

### Mouthpiece Inserts

BLS404S	Tenor Slim.....	\$10.00B
BLS404T	Tenor Wide.....	\$10.00B

## MEYER



### ALTO SAX (METAL)

JMMAS	Jazz.....	\$247.00B
-------	-----------	-----------

### TENOR SAX (METAL)

MMMMS	.....	\$290.00B
JMMMS	Jazz.....	\$290.00B
MCAP	Tenor Sax Cap.....	\$8.90B
MLIG	Tenor Sax Ligature.....	\$10.75B

### (RUBBER)

MMRAS	5, 6, 7, Alto.....	\$137.00D
MMRTS	5, 6, 7, Tenor.....	\$155.00D
MG18	5, 6, 7 Alto Sax.....	\$137.00D
RC5M	Richie Cole, Alto.....	\$168.00D
MMRBS	5, 6, 7, 8 Bari.....	\$217.00D
MMRSS	5, 6, 7, Soprano.....	\$137.00D

## LA VOZ



### SMART PACK

Includes: Mouthpiece, Cap, Lig, 2 Reeds, Reed Gard II, Cork Grease, Mouthpiece Saver

LVCLSP	Clarinet.....	\$54.00
LVASSP	Alto Sax.....	\$60.75
LVASMP	A Sax MPC only.....	\$45.00

## BARI



### ESPRIT KITS

45SCLKIT	Clarinet.....	\$26.65
72SASKIT	Alto Sax.....	\$29.05
85STSKIT	Tenor Sax.....	\$32.85

### CLARINET

45SCLBARI	(Synthetic).....	\$16.33
FCLBARI	(Buddy De Franco) 53, 58.....	\$108.44

### SOPRANO SAX

RSSBARI	(Rubber).....	\$119.79
---------	---------------	----------

### ALTO SAX

72SASBARI	(Synthetic).....	\$20.15
RASBARI	(Rubber).....	\$114.26
7CASBARI	(Richie Cole).....	\$111.15
MTSBARI	(Gold), .075, .080.....	\$279.75

### TENOR SAX

85 STSBARI	(Synthetic).....	\$21.15
RTSBARI	(Rubber).....	\$122.77
MTSBARI	(Gold), .110.....	\$291.30

### PLASTIC

BCLMP	Clarinet.....	\$11.85
BASMP	Alto Sax.....	\$10.65
BTSMP	Tenor Sax.....	\$10.75
75BCMPK	Bass Clarinet Kit.....	\$71.53
78BSMPK	Bari Sax Kit.....	\$120.00

## GIGLIOTTI



Hard Rubber Clarinet Mouthpieces

G	.....	\$120.00B
---	-------	-----------

(G2, G3, G4, GP, GP34)

## FAXX HARD RUBBER

B45FCLA	Clarinet.....	\$77.65
MFAS	Alto Sax 5, 6, 7.....	\$84.30
F402C*	Alto Sax.....	\$116.80
5*FTS	Tenor Sax.....	\$94.30

## JEWEL



### PERFORMANCE

JPCL	Clarinet.....	\$30.95
JPAS	Alto Sax.....	\$37.15
JPTS	Tenor Sax.....	\$43.35

### CONCERT

JB45CL	Clarinet.....	\$65.10
JCCL	Clarinet.....	\$81.30
JCBCL	Bass Clarinet.....	\$118.25
5JCAS	Alto Sax.....	\$88.40
5ICTS	Tenor Sax.....	\$90.60
5ICSS	Soprano Sax.....	\$88.25
5ICBS	Bari Sax.....	\$118.25

## BELMONTE



58455	Alto Silver #5.....	\$174.90
58457	Alto Silver #7.....	\$174.90
58475	Tenor Silver #5.....	\$200.50
58477	Tenor Silver #7.....	\$200.50

## OTTO LINK



### LCAP

Tenor, Alto mouthpiece cap.....\$9.75B  
Metal Mouthpieces

LLIG	Alto, Tenor Sax, Ligature.....	\$21.15B
BSCL	Bari Sax cap & Lig.....	\$31.50B
SSCL	Sop Sax cap & Lig.....	\$29.50B

### STONE EDGE (HARD RUBBER)

LRCL	Bb Clarinet.....	\$117.00B
LRAS	Eb Alto Sax.....	\$127.00B
LRTS	Bb Tenor Sax.....	\$146.00B
LRBS	Eb Bari Sax.....	\$214.00B
LRSS	Bb Soprano Sax.....	\$127.00B
RGRTS	Tenor, 108.....	\$146.00B
VRTS	Vintage Tenor Sax.....	\$209.00B

### SUPER TONE MASTER (BELL METAL)

LMSS	Bb Soprano Sax.....	\$256.00B
LMAS	Eb Alto Sax.....	\$297.00B
LMTS	Bb Tenor Sax.....	\$319.00B
LMBS	Eb Bari Sax.....	\$368.00B
RGMTS	Tenor, 118.....	\$319.00B
VMTS	Vintage Tenor Sax.....	\$389.00B

### REGLEIN MODEL, METAL, JAZZ

#### (J5, J6, J7, J8 Facings)

AS	Alto Sax.....	\$243.00B
TS	Tenor Sax.....	\$270.00B
BS	Bari Sax.....	\$285.00B

### NEW YORK METAL

NYMTS	Tenor Sax.....	\$319.00B
3MLNY	Rovner Ligature.....	\$36.95

## WOLFE TAYNE



### TENOR SAX LIGATURE

TLIG Metal	.....	\$8.40B
------------	-------	---------

### METAL

TMAS	Alto Sax.....	\$233.00B
TMTS	Tenor Sax.....	\$233.00B

## WOODWIND



### EDUCATOR (BLACK PLASTIC)

G82610	Clarinet, G8.....	\$35.00
B52615	Tenor Sax, B5.....	\$50.00

### LARRY COMBS—CLARINET

LC32571	Personal Model - LC3.....	\$156.00B
LC12571	Closer Facing - LC1.....	\$156.00B

### ROBERT MARCELLUS

RM132591	Clarinet (Personal).....	\$156.00B
----------	--------------------------	-----------

# SELMER MOUTHPIECES



## PARIS CLARINET, RUBBER

<b>S200</b>	Eb Soprano Clarinet .....	<b>\$219.00</b>
<b>S202</b>	Alto Clarinet .....	<b>360.00</b>
<b>SS203FC</b>	Bass Clarinet (Focus) .....	<b>440.00</b>
<b>SS203CN</b>	Bass Clarinet (Concept) .....	<b>440.00</b>
<b>S204</b>	EEb Contra-alto Clarinet .....	<b>562.00</b>
<b>S205</b>	BBb Contrabass Clarinet .....	<b>786.00</b>

FACINGS: HS\*,B,B\*,C,C\*,C\*\*,S,E,F,G,H, HS\*\*  
Focus closer opening, Concept larger opening



## PARIS SAXOPHONE S80 HARD RUBBER

<b>SS401</b>	Soprano Saxophone .....	<b>\$225.00</b>
<b>SE401</b>	Sopranino Saxophone .....	<b>315.00</b>
<b>SS402</b>	Alto Saxophone .....	<b>281.00</b>
<b>SS404</b>	Tenor Saxophone .....	<b>326.05</b>
<b>SS405</b>	Baritone Saxophone .....	<b>461.00</b>
<b>SS406</b>	Bass Saxophone .....	<b>631.90</b>

FACINGS: B\*,C,C\*C\*\*,D,E,F,G,H,I,J,K

## S90 HARD RUBBER

<b>SS412</b>	Alto Saxophone .....	<b>\$270.00</b>
<b>SS414</b>	Tenor Saxophone .....	<b>371.00</b>

FACINGS: 170,180,190,200

## LARRY TEAL

<b>SLT402</b>	Alto Saxophone .....	<b>\$450.00</b>
---------------	----------------------	-----------------



## CLASSIC METAL

<b>SM401</b>	Soprano Saxophone .....	<b>\$646.00</b>
<b>SM402</b>	Alto Saxophone .....	<b>666.00</b>
<b>SM404</b>	Tenor Saxophone .....	<b>719.00</b>

FACINGS: C\*C\*\*,D,E,F,

## JAZZ METAL

<b>SMJ402</b>	Alto Saxophone .....	<b>\$726.00</b>
<b>SMJ404</b>	Tenor Saxophone .....	<b>817.45</b>

FACINGS: C,C\*C\*\*,D,E,F,G,H



## BRILLHART EBOLIN

<b>SBE201</b>	Clarinet .....	<b>\$49.00</b>
<b>SBE402</b>	Alto Saxophone .....	<b>62.00</b>
<b>SBE404</b>	Tenor Saxophone .....	<b>79.00</b>

FACINGS: 2\*,3\*,4\*,5\*,2,3,4,5



## RIDENOUR CLARINET

<b>SE201</b>	Encore Clarinet .....	<b>\$44.00</b>
<b>SE203</b>	Encore Bass Clarinet .....	<b>66.00</b>



## BRILLHART LEVEL AIR

<b>SM2002</b>	Alto Saxophone .....	<b>\$228.00</b>
<b>SM2004</b>	Tenor Saxophone .....	<b>241.00</b>
<b>SM2005</b>	Baritone Saxophone .....	<b>291.00</b>

FACINGS: 3, 4, 5, 6, 7, 8, 9

## BRILLHART LEVEL-AIR CAPS, LIGATURES & BUFFLES.

<b>SMC2002</b>	Alto Saxophone Cap .....	<b>\$7.00</b>
<b>SML2002</b>	Alto Saxophone Ligature .....	<b>18.00</b>
<b>SMC2004</b>	Tenor Saxophone Cap .....	<b>7.00</b>
<b>SML2004</b>	Tenor Saxophone Ligature .....	<b>18.00</b>
<b>SML2005</b>	Baritone Saxophone Ligature .....	<b>18.00</b>



## BUNDY SIGNATURE HARD RUBBER

Available for all members of the clarinet and saxophone family, these mouthpieces fill the need for a student mouthpiece with professional features, such as hand-adjusted baffles for rich, centered tone quality and balanced rails for even response. Available in three facings: No. 2, medium close; No. 3, medium; No. 4, medium open.

<b>SB200</b>	Eb Soprano Clarinet .....	<b>\$80.00</b>
<b>SBR201</b>	Bb Clarinet .....	<b>75.00</b>
<b>SB202</b>	Alto Clarinet .....	<b>87.00</b>
<b>SB203</b>	Bass Clarinet .....	<b>100.00</b>
<b>SB204</b>	Contra-alto Clarinet .....	<b>112.00</b>
<b>SB401</b>	Soprano Saxophone .....	<b>78.00</b>
<b>SBR402</b>	Alto Saxophone .....	<b>78.00</b>
<b>SBR404</b>	Tenor Saxophone .....	<b>94.00</b>
<b>SBX405</b>	Baritone Saxophone streamlined model .....	<b>137.20</b>

# SELMER EZ TONE



Includes mouthpiece, cap, and ligature.

<b>S241CK</b>	Clarinet.....	<b>\$30.00</b>
<b>S241AK</b>	Alto Sax.....	<b>37.00</b>
<b>S241TK</b>	Tenor Sax.....	<b>43.00</b>



## GOLDENTONE

<b>S7711</b>	Clarinet .....	<b>\$25.00</b>
<b>S7712</b>	Alto Saxophone .....	<b>28.00</b>
<b>S7713</b>	Tenor Saxophone .....	<b>33.00</b>

FACINGS: 2,3,4 Clarinet, 3 Alto/Tenor Sax



## BRILLHART SPECIAL MOUTHPIECES

Designed and priced for the student, these mouthpieces measure up to the Brillhart reputation for value and quality. The medium facing plays equally well using either a hard or soft reed. Made of injection-molded plastic. Available in medium facing only.

<b>SBS201</b>	Clarinet .....	<b>\$43.00</b>
<b>SBS203</b>	Bass Clarinet .....	<b>56.00</b>
<b>SBS402</b>	Alto Saxophone .....	<b>48.00</b>
<b>SBS404</b>	Tenor Saxophone .....	<b>52.00</b>
<b>SBS405</b>	Baritone Saxophone .....	<b>104.00</b>



## BUNDY ORIGINAL

Original equipment on Models 1400 & 1401 clarinets and Bundy II saxophones. They are acoustically matched to the instrument for optimum response and intonation. Molded from durable plastic material.

<b>SBP201</b>	Bundy Clarinet .....	<b>\$30.00</b>
<b>SBP402</b>	Bundy Alto Saxophone .....	<b>33.00</b>
<b>SBP404</b>	Bundy Tenor Saxophone .....	<b>43.00</b>

FACINGS: Medium only

# ACCESSORIES

## CLARINET TUNING RINGS.

Precision made of hard rubber. Set consists of one each, .5mm, 1mm, 2mm.

<b>SS265</b>	.....	<b>\$36.70</b>
--------------	-------	----------------

(PRICES SUBJECT TO CHANGE WITHOUT NOTICE)

[www.conn-selmer.com](http://www.conn-selmer.com)

# MOUTHPIECES

## YAMAHA



### Bb CLARINET

YAC 1266	4C	\$55.99
YAC 1267	5C	\$55.99

### Bb SOPRANO SAXOPHONE

YAC 1281	4C	\$46.99
----------	----	---------

### Eb ALTO SAXOPHONE

YAC 1286	4C	\$46.99
YAC 1287	5C	\$46.99

### Bb TENOR SAXOPHONE

YAC 1290	3C	\$48.99
YAC 1291	4C	\$48.99
YAC 1292	5C	\$48.99
YAC 1293	6C	\$48.99

### Eb BARITONE SAXOPHONE

YAC 1295	5C	\$77.99
----------	----	---------

### Eb SOP CLARINET

YAC 1261	4C	\$55.99
----------	----	---------

### Eb ALTO CLARINET

YAC 1270	4C	\$55.99
----------	----	---------

### Bb BASS CLARINET

YAC 1276	4C	\$61.99
YAC 1275	3C	\$61.99

## YANAGISAWA



### SILVER PLATED BRASS

Y2704	Alto Sax	\$314.15
Y2705	Tenor Sax	\$372.00
Y2706	Baritone Sax	\$457.00
Y2707	Soprano Sax	\$266.00
Y2708	Sopranino Sax	\$202.00

(Facings: 3,5,7,9)

### HARD RUBBER

Y3704	Alto Sax	\$213.00
Y3705	Tenor Sax	\$229.00
Y3706	Baritone Sax	\$346.00
Y3707	Soprano Sax	\$213.00
Y3708	Sopranino Sax	\$202.00

(Facings: 5,6,7,8,9)

## CLAUDE LAKEY



<b>CLARINET</b>	CLOC5*, CLOC6*, CLOC7*, CLOC8*	\$104.95B
<b>ALTO SAX</b>	CLOA4*3, CLOA5*3, CLOA6*3, CLOA7*3, CLOA8*3,	104.95B
<b>TENOR SAX</b>	CLOT4*3, CLOT5*3, CLOT6*3, CLOT7*3, CLOT8*3, CLOT9*3	104.95B
<b>SOPRANO SAX</b>	CLOS5*, CLOS6*, CLOS7*, CLOS8*	104.95B

Note: All mouthpieces come w/compass cap and ligature

<b>CLAUDE LAKEY COMPASS LIGATURE</b>		
CL3		\$39.95B

Comes with 3 caps Alto/Tenor/Soprano

<b>APOLLO BRASS MOUTHPIECE</b>		
<b>ALTO SAX</b>	CLAAB6*, CLAAB7*, CLAAB8*	\$249.95B
<b>TENOR SAX</b>	CLATB6*, CLATB7*, CLATB8*	249.95B

Note: All mouthpieces come w/compass cap and ligature

<b>APOLLO EBOINITE MOUTHPIECE</b>		
<b>ALTO SAX</b>	CLAAE6*, CLAAE7*, CLAAE8*	\$249.95B
<b>TENOR SAX</b>	CLATE6*, CLATE7*, CLATE8*	249.95B

Note: All mouthpieces come w/compass cap and ligature

## CHOP SAVER



### For Musicians With Lips

ChopSaver combines the goodness of herbs, aloe and Vitamin E in a rich shea and mango butter base kissed with the essential oils of citrus fruits.

<b>CHOP</b>		\$4.95
<b>CSGOLD</b>	w/Sunblock	4.95
<b>CHPR24</b>	24 Pak Chopsaver	118.80
<b>CHPS24</b>	24 Pak Chopsaver Gold	118.80

## BERP



Allows you to buzz mouthpiece while on your instrument.

<b>BERPTR</b>	Trumpet (3)	\$21.95B
<b>BERPCO</b>	Cornet (2)	21.95B
<b>BERPFH</b>	French Horn (1)	21.95B
<b>BERPST</b>	Trombone, small shank (4)	21.95B
<b>BERPSTL</b>	Trombone, large shank (5)	21.95B
<b>BERPTU</b>	Tuba (6)	21.95B
<b>BERPBH</b>	Baritone, small shank (4)	21.95B
<b>BERPWIM</b>	Euphonium (4)	21.95B
<b>BERPBB</b>	Instructional audio CD	19.95*
<b>BBG</b>	Bio Grease	5.95B
<b>BBO</b>	Bio Oil	7.49

## YAMAHA



### TRUMPET

YAC TR11B4	11B4	\$61.99
YAC TR11C4	11C4-7C	61.99
YAC TR14A4A	14A4-A	61.99
YAC TR14B4	14B4	61.99
YAC TR14C4	14C4	61.99
YAC TR16C4	16C4	61.99
YAC TR17C4	17C4	61.99
YAC TR6A4A	6A4A	61.99
YAC SHEWL	Bobby Shew	74.99B
YAC SHEWJ	Bobby Shew	74.99B

### CORNET

YAC CR9E	9E	\$61.99
YAC CR11C4	11C4-7C	61.99
YAC* CR11C4	11C4	61.99
YAC* CR14B4	14B4 (Long Shank)	61.99
YAC* CR15C4	15C4 (Long Shank)	61.99
YAC* CR17C4	17C4 (Long Shank)	61.99
YACCRL11A4	11A4 (Long Shank)	61.99
YACCRL11B4	11B4 (Long Shank)	61.99
YACCRL14A4A	4A4A (Long Shank)	61.99

### FLUGELHORN

YAC FH11F4	11F4	\$61.99
YAC FH13F4	13F4	61.99
YAC FH14F4	14F4	61.99

### ALTO HORN

YAC AH37C4	37C4	\$61.99
------------	------	---------

### TROMBONE

NUMBER	MODEL	PRICE
YAC SL45C2	45C2-12C	\$74.99
YAC SL46C2	46C2	74.99
YAC SL47	47	74.99
YAC SL48	48	74.99
YAC SL48A	48A	74.99
YAC SL51	51	74.99
YAC SL51B	51B	74.99
YAC SL51C4	51C4	74.99
YAC SL51D	51D	74.99
YAC* SL48	48 (Large Shank)	74.99
YAC* SL51D	51D (Large Shank)	74.99
YAC* SL52	52 (Large Shank)	74.99

### BASS TROMBONE

YAC BL59	BL59	\$84.99
----------	------	---------

### TUBA

YAC BB66	BB66	\$105.99
YAC BB66D4	BB66D4	105.99
YAC BB67	BB67	105.99
YAC BB67C4	BB67C4	105.99

### FRENCH HORN

YAC HR29C4	29C4	\$61.99
YAC HR30B	30B	61.99
YAC HR30C4	30C4	61.99
YAC HR30D4	30D4	61.99
YAC HR32C4	32C4	61.99

### REPLICA SERIES

YAC VIZZ-REP	Allen Vizzutti; Trumpet	\$74.99B
--------------	----------------------------	----------

# MOUTHPIECES

## BACH



### STANDARD

S351	Trumpet	\$84.00
S349	Cornet	84.00
S342	Fluegelhorn	84.00
S336	Frenchhorn	77.00
SA337	Alto Horn	91.00
SM337	Mellophone	75.62
S350	Trombone/Baritone	106.00
S341	Bass Trombone	109.00
S335	Tuba/Sousaphone	135.00
S340	Contra Bass Trombone	111.25

Gold plating available. Call for price information.

### MEGATONE

SK351	Trumpet	\$150.00
SK349	Cornet	150.00
SK342	Fluegelhorn	150.00
SK350	Trombone	178.00
SK341	Bass Trombone	181.00
SK335	Tuba/Sousaphone	212.00

Available in all popular cup sizes

## MARCINKIEWICZ



MT112C	1-1/2 C Trumpet	\$91.00D
MT7	7 Trumpet	91.00D
MTE8	Rick Baptist Trumpet	91.00D
MTE13	Chuck Finley Trumpet	91.00D
MTE5	E2 Shew Trumpet	91.00D
MTE16	Candoli Trumpet	91.00D
MTE12	Vizzuti Trumpet	91.00D
MTE103	Shew 1-1/4 Trumpet	91.00D
MTE9	Kline Trumpet	91.00D
MTE91	E1.5 Shew Trumpet	91.00D
MTE14	E1 Shew Trumpet	91.00D
MTE124	E12.4 Roger Ingram Trumpet	91.00D
MT47C	4/7C Trumpet	91.00D
MTE33C	E3/3C Trumpet	91.00D
MT35C	3/5C Trumpet	91.00D
MT35	35 Trumpet	91.00D
MT55	55 Trumpet	91.00D
MTE122	E12.2 Trumpet Mike VAX1	91.00D
MTE141	Cacia E14.1 Trumpet	91.00D
MC3C	3C Cornet	91.00D
MC5	#5 Cornet	91.00D
MF3FLB	3 FLB Fluegelhorn	91.00D
MF5FLB	5 FLB Fluegelhorn	91.00D
MF7FLB	7 FLB Fluegelhorn	91.00D
MFBSFL	BSFL Shew Fluegelhorn	91.00D
MTT12C	T-Bone	102.00D
MTTE7	T-Bone	102.00D
MTT612AL	6-1/2 AL T-Bone	102.00D
MTT5GW	5GW T-Bone	102.00D
MTT9B	9B T-Bone	102.00D
MTTET17	ET 1.7 Whigham T-Bone	102.00D
MTTET2	Ian McDougal, T-Bone	102.00D
MTTET3	Charlie Loper, T-Bone	102.00D
MBT5GWBS	5GW-BS Bass T-Bone	102.00D
MBTEBT2	EBT2 Phil Teels Bass T-Bone	102.00D
MTUN4	N4 Tommy Johnson Tuba	165.00D
MTUH1	H1 Tuba	165.00D
MTU24AW	24AW Tuba	165.00D
MTUW2	W2 Tuba	165.00D

(Additional Sizes Available)

## FARKAS



### FRENCH HORN MOUTHPIECES

H2850DC	Deep Cup	\$83.00
H2850MC	Medium Cup	83.00
H2850MDC	Medium Deep Cup	83.00
H2850SC	Shallow Cup	83.00
H2850VDC	Very Deep Cup	83.00
H2850XDC	Extra Deep Cup	83.00
H2850GMC	Gold Medium Cup	173.00
H2850GMDC	Gold Medium Deep Cup	173.00
H2850GSC	Gold Shallow Cup	173.00
H2850GXDC	Gold Extra Deep Cup	173.00
H2850DIS	Holds 6 Mouthpieces Mouthpiece Display	117.00

## PARDUBA

### DOUBLE CUP

PARTP2	Trumpet	\$102.00
PARTP25	Trumpet	102.00
PARTP3	Trumpet	102.00
PARTP35	Trumpet	102.00
PARTP4	Trumpet	102.00
PARTP45	Trumpet	102.00
PARTP5	Trumpet	102.00
PARTP55	Trumpet	102.00
PARTP6	Trumpet	102.00
PARTP65	Trumpet	102.00
PARTP7	Trumpet	102.00
PARTP75	Trumpet	102.00
PARTP8	Trumpet	102.00
PARTP45HJ	Harry James	102.00
PARTP5HJ	Harry James	102.00
PARTP55HJ	Harry James	102.00
PARTB2	Trombone	126.00
PARTB25	Trombone	126.00
PARTB3	Trombone	126.00
PARTB3*	Trombone	126.00
PARTB35	Trombone	126.00
PARTB4	Trombone	126.00
PARTB45	Trombone	126.00
PARTB5	Trombone	126.00
PARTU73	Tuba	199.00
PARC3	Cornet	102.00
PARC4	Cornet	102.00
PARC45	Cornet	102.00
PARC5	Cornet	102.00
PARC55	Cornet	102.00
PARC6	Cornet	102.00
PARC65	Cornet	102.00
PARC45HJ	Cornet James	102.00
PARC55HJ	Cornet James	102.00
PARC55HJ	Cornet James	102.00
PARF35	Fluegelhorn	102.00
PARF4	Fluegelhorn	102.00
PARF45	Fluegelhorn	102.00
PARF5	Fluegelhorn	102.00
PARF55	Fluegelhorn	102.00
PARF6	Fluegelhorn	102.00
PARF65	Fluegelhorn	102.00
PARF7	Fluegelhorn	102.00
PARF8	Fluegelhorn	102.00

## HELLEBERG



S1705E	Euphonium Standard	\$77.00
S1205	Tuba Standard	120.00
S1207B	Tuba 7B	120.00

## STORK



VT2B	Trumpet 2B	\$78.50B
VT2C	Trumpet 2C	78.50B
VT2D	Trumpet 2D	78.50B
VT3B	Trumpet 3B	78.50B
VT3C	Trumpet 3C	78.50B
VT3D	Trumpet 3D	78.50B
VT4C	Trumpet 4C	78.50B
VT4D	Trumpet 4D	78.50B
VT5B	Trumpet 5B	78.50B
VT5C	Trumpet 5C	78.50B
VT7C	Trumpet 7C	78.50B
VT15C	Trumpet 1.5C	78.50B
VSM1	Trumpet 1	78.50B
SMTLX6	Trumpet LX7	78.50B
SMTVM6	Trumpet VM6	78.50B
SMTXV6	Trumpet XV6	78.50B
SMTLT10	Trumpet LT10	78.50B
SMTLX10	Trumpet LX10	78.50B
SMTVM10	Trumpet VM10	78.50B
SMTXM10	Trumpet XM10	78.50B
SMTXV10	Trumpet XV10	78.50B
VPC3P	Picc Corn 3P	78.50B
VPC5P	Picc Corn 5P	78.50B
VPT2P	Picc Trum 2P	78.50B
VPT5P	Picc Trum 5P	78.50B
VF2FL	Fluegelhorn 2FL	78.50B
VF15FL	Fluegelhorn 1.5FL	78.50B
VF2FLS	Fluegelhorn 2FLS	78.50B
VF3FLS	Fluegelhorn 3FLS	78.50B
VF15FLS	Fluegelhorn 1.5FLS	78.50B
SMFFL6	Fluegelhorn FL6	78.50B
SMFFLS6	Fluegelhorn FLS6	78.50B
CST1	Bass Trombone 1	84.00B
CST3	Bass Trombone	84.00B
CST4	Bass Trombone 4	84.00B
CST15	Bass Trombone 1.5	84.00B
CSTT1	Trombone T1	84.00B
CSFHC1	French Horn C1	78.50B
CSFHC8	French Horn C8	78.50B
CSFHC10	French Horn C10	78.50B
CSFHC12	French Horn C12	78.50B
OSFH04	French Horn 04	95.00B
OSFH05	French Horn 05	95.00B
MFHM8	French Horn Myers M8	95.00B

## RUDY MUCK



### CUSHION RIM

RMTP13C	Trumpet	\$110.00
RMTP17C	Trumpet	110.00
RMTP19C	Trumpet	110.00
RMTRB21	Trombone	138.00
RMTRB23	Trombone	138.00
RMTRB25	Trombone	138.00
RMTRB26	Trombone	138.00



# MOUTHPIECES

## SCHILKE



SC9	9 Trumpet.....	\$78.00B
SC11	11 Trumpet.....	78.00B
SC14	14 Trumpet.....	78.00B
SC15	15 Trumpet.....	78.00B
SC17	17 Trumpet.....	78.00B
SC15B	15B Trumpet.....	78.00B
SC13C4	13C4 Trumpet.....	78.00B
SC14A4	14A4 Trumpet.....	78.00B
SC6A4A	6A4A Trumpet.....	78.00B
SC12A4A	12A4A Trumpet.....	78.00B
SC13A4A	13A4A Trumpet.....	78.00B
SC14A4A	14A4A Trumpet.....	78.00B
SC15A4A	15A4A Trumpet.....	78.00B
SC11C2	11C2 Trumpet.....	78.00B
SC12	12 Trumpet.....	78.00B
SC12A4	12A4 Trumpet.....	78.00B
SC12B4	12B4 Trumpet.....	78.00B
SC13	13 Trumpet.....	78.00B
SC13A4	13A4 Trumpet.....	78.00B
SC14C2	14C2 Trumpet.....	78.00B
SC15A4	15A4 Trumpet.....	78.00B
SC15	15 Trumpet.....	78.00B
SC15C4	15C4 Trumpet.....	78.00B
SC16	16 Trumpet.....	78.00B
SC16C4	16C4 Trumpet.....	78.00B
SC17D4	17D4 Trumpet.....	78.00B
SC17D4D	17D4D Trumpet.....	78.00B
SC18	18 Trumpet.....	78.00B
SC18C3D	18C3D Trumpet.....	78.00B
SC19	19 Trumpet.....	78.00B
SC20	20 Trumpet.....	78.00B
SC20D2D	20D2D Trumpet.....	78.00B
SC22	22 Trumpet.....	78.00B
SC5A4	5A4 Trumpet.....	78.00B
SC13	13 Trumpet.....	78.00B
SC13D4	13DA Trumpet.....	78.00B
SC17B4	17B4 Trumpet.....	78.00B
SC18B4	18B4 Trumpet.....	78.00B
SC16B4	16B4 Trumpet.....	78.00B

### HEAVYWEIGHT

SC6A4AHVY	64AA Trumpet.....	\$132.50B
SC13A4AHVY	13A4A Trumpet.....	132.50B
SC14A4AHVY	14A4A Trumpet.....	132.50B
SC15A4AHVY	15A4A Trumpet.....	132.50B
SC15HVY	15 Trumpet.....	132.50B



SCC7B4	7 B4 Cornet.....	\$78.00B
SCC11AX	11AX Cornet.....	78.00B
SCC13A4A	13A4A Cornet.....	78.00B
SCC14A4	14A4 Cornet.....	78.00B
SCC14A4A	14A4A Cornet.....	78.00B
SCC14A4X	14A4X Cornet.....	78.00B
SCC15C4	15C4 Cornet.....	78.00B

www.schilke.com

## SOUND SLEEVE



Make your horn more vibration free at the front end.  
SS .....\$19.20B



SC27	27 French Horn.....	\$78.00B
SC29	29 French Horn.....	78.00B
SC30	30 French Horn.....	78.00B
SC31	31 French Horn.....	78.00B
SC30B	30B French Horn.....	78.00B
SC30C2	30C French Horn.....	78.00B
SC31B	31B French Horn.....	78.00B
SC31C2	31C2 French Horn.....	78.00B
SC32	32 French Horn.....	78.00B



SC42TTB	42 Trombone.....	\$100.00B
SC46TTB	46 Trombone.....	100.00B
SC47TTB	47 Trombone.....	100.00B
SC50TTB	50 Trombone.....	100.00B
SC51TTB	51 Trombone.....	100.00B
SC51BTTB	51B Trombone.....	100.00B
SC51DTTB	51D Trombone.....	100.00B
SC51C4TTB	51C4 Trombone.....	100.00B



SC50C4BTB	50C4 Bass Trombone.....	\$100.00B
SC50BTB	50 Bass Trombone.....	100.00B
SC51BTB	51 Bass Trombone.....	100.00B
SC51C4BTB	51C4 Bass Trombone.....	100.00B
SC59BTB	59 Bass Trombone.....	100.00B
SC60BTB	60 Bass Trombone.....	100.00B
SC51DBTBE	51D Bass Tromb Euro Shank.....	141.00B
SC51BTBE	51 Bass Tromb Euro Shank.....	141.00B
SC51BBTB	51B Bass Trombone.....	100.00B
SC51DBTB	51D Bass Trombone.....	100.00B
SC52BTB	52 Bass Trombone.....	100.00B
SC52DBTB	52D Bass Trombone.....	100.00B
SC52E2BTB	52E2 Bass Trombone.....	100.00B



SC62	62 Tuba.....	\$148.00B
SC66	66 Tuba.....	148.00B
SC67	67 Tuba.....	148.00B
SCSH	SH Tuba.....	148.00B

## FAXX BRASS MOUTHPIECES

All in Clamshell Package

FTRPT	Trumpet 1.25C, 1.5C, 5B, 5C, 7C, 10.5C.....	\$36.45
FCORN	Cornet 3C, 5C, 7C.....	36.45
FFLUG	Flugelhorn 3C, 5C.....	36.45
FTBN	Tenor Trombone 6.5AL, 7C, 12C.....	52.95
FBTBN	Bass Trombone - Large Shank 1.5G, 4G, 5G, 6.5AL.....	54.90
FTUSOU	Tuba/Sousa 18, 24AW, 25.....	88.95
FHB	Tuba 120, 7B.....	91.05
FHORN	French Horn 2, 11.....	36.45
FHORN	French Horn MC, MDC.....	36.45
FHORN	French Horn C6, C8, C10, C12.....	36.45

## DEG DYNASTY



DEG13	Cornet 7C.....	\$32.00B
DEG11	Trumpet 3C, 5C, 7C.....	32.00B
DEG14	Flugelhorn 7C.....	32.00B
DEG16	French Horn 11, 12.....	32.00B
DEG15	Mellophone/Marching 6V.....	32.00B
DEG12	Trombone/Baritone 6 1/2AL, 12C.....	48.00B
DEG18	Bass Trombone 6 1/2AL, 1 1/2G.....	48.00B
DEG17	BBb Tuba 24AW.....	85.00B

## BLESSING



BMP11	Trumpet, 7C, 10 1/2C, 5C, 3C, 1 1/2C.....	\$42.00
BMP13	Cornet, 7C, 10 1/2C, 5C.....	42.00
BMP14	Flugelhorn, 3.....	42.00
BMP12	Trombone/Baritone, 12C, 6 1/2AL, 7C, 11C.....	60.50
BMP16	French Horn, 11, 7.....	42.00
BMP17	Tuba, 18, 24AW.....	105.60
BMP15	Mellophone, 5, 6.....	55.60
BMP18	Bass Trombone, 4G, 6 1/2AL.....	62.20

## STUDENT



YT1	Trumpet 7C.....	\$13.20
YT5	Cornet 7C.....	12.60
YT3	French Horn 11.....	16.20
YT2	Trombone 12C.....	21.15
YT4	Tuba 18.....	45.00

## AMPLATE

APTRP3C	Trumpet.....	\$32.70
APTRP5C	Trumpet.....	32.70
APTRP7C	Trumpet.....	31.75
APTRB612AL	Trombone 6 1/2AL Mouthpiece.....	45.60
APTRB12C	Trombone 12C Mouthpiece.....	45.60
APTU18	Tuba 18 Mouthpiece.....	81.00
APTU24AW	Tuba 24AW Mouthpiece.....	81.00
APFH11	French Horn.....	35.95

## MUTEC MOUTHPIECES

SILVER PLATED BRASS

MTC	Trumpet.....	\$50.00
	3A, 3C, 3E, 5A, 5C, 5E, 7A, 7C, 7E	

POLYMER

MTC	Trumpet 3C, 5C, 7C.....	\$15.00
	(BK) Black, (CL) Clear	
	(i.e., MTC3CBK or MTC3CCL)	

## HEAVY VALVE CAPS



Twice the weight of standard bottom valve caps.

S1810	Lacquer finish.....	\$39.00
S1810S	Silver plate finish.....	45.00
S1810G	Gold plate finish.....	72.00
GOLD PLATED TRIM KITS		
S1811G	Standard Bottom Caps.....	\$276.00
S1812G	Heavy Bottom Caps.....	276.00

# DENIS WICK



## MOUTHPIECES

<b>W4882</b>	Trumpet, Gold.....	<b>\$147.99</b>
<b>W5882</b>	Trumpet, Silver.....	<b>103.99</b>
<b>W4881</b>	Cornet, Gold.....	<b>132.99</b>
<b>W5881</b>	Cornet, Silver.....	<b>89.99</b>
<b>W4884</b>	Flugelhorn, Gold.....	<b>132.99</b>
<b>W5884</b>	Flugelhorn, Silver.....	<b>89.99</b>
<b>W4885</b>	French Horn, Gold.....	<b>147.99</b>
<b>W5885</b>	French Horn, Silver.....	<b>103.99</b>
<b>W4883</b>	Tenor Horn, Gold.....	<b>147.99</b>
<b>W5883</b>	Tenor Horn, Silver.....	<b>103.99</b>
<b>W4880</b>	Trombone, Gold.....	<b>182.99</b>
<b>W5880</b>	Trombone, Silver.....	<b>118.99</b>
<b>W4880E</b>	Euphonium, Gold.....	<b>211.99</b>
<b>W5880E</b>	Euphonium, Silver.....	<b>150.99</b>
<b>W4880B</b>	Baritone, Gold.....	<b>211.99</b>
<b>W5880B</b>	Baritone, Silver.....	<b>150.99</b>
<b>W4286</b>	Tuba, Gold.....	<b>260.99</b>
<b>W5886</b>	Tuba, Silver.....	<b>160.99</b>

## CUP SIZES

<b>Trumpet:</b>	1X, 1W, 1CW, 1-1/2C, 2W, 3, 3C, 3E,4, 4B, 4C, 4E, 4X, 5, 5E, 5X
<b>Cornet:</b>	2, 2B, 2BW, 3, 3B, 4, 4B, 4W, 4BW, 4.5, 5, 5B, S, RW3, RW3B, RW3B RW4, RW4B
<b>Flugelhorn:</b>	2F, 2FL, 4F, 4FL, 2BFL, 3BFL, 4BFL, 5BFL, SBFL
<b>French Horn:</b>	4, 4N, 5, 5N, 6N, 7, 7N
<b>Tenor Horn:</b>	2,3,5
<b>Trombone:</b>	3AL, 4AL, 4BL, 4BS, 4-1/2AL, 5AL, 5ABL, 5BL, 5BS, 6BL, 6BS, 7CS, 9BL, 9BS, 10CS, 12CS
<b>Euphonium:</b>	OAL, 1AL, 2AL, 2NAL, 4AM, 4AY, 6BM, 6BY, SM2, SM3, SM5, 5, SM4
<b>Baritone:</b>	SM4, SM6, SM9
<b>Tuba:</b>	1, 1L, 2, 2L, 3, 3L, 2SL, 3SL4AL, 5, 5L, 1XL, 2XL, 3XL



## BOOSTERS

Converts any Mouthpiece to a Heavytop

<b>W6180</b>	Cornet.....	<b>\$71.99</b>
<b>W6181</b>	Trumpet.....	<b>71.99</b>
<b>W6183</b>	French Horn.....	<b>71.99</b>
<b>W6182S</b>	Trombone.....	<b>87.99</b>
<b>W6182L</b>	Bass Trombone.....	<b>83.99</b>
<b>W6182LB</b>	Large Bore Amer. Fit.....	<b>83.99</b>



## HEAVYTOPS

Sound Enhanced Mouthpieces

<b>TRUMPET</b>		
<b>W68821</b>	17.25mm.....	<b>\$119.99</b>
<b>W68821C</b>	17.25mm.....	<b>119.99</b>
<b>W68822</b>	17.00mm.....	<b>119.99</b>
<b>W68823</b>	16.75mm.....	<b>119.99</b>
<b>W68823C</b>	16.75mm.....	<b>119.99</b>
<b>W68824X</b>	16.50mm.....	<b>119.99</b>
<b>CORNET</b>		
<b>3BW6881</b>	16.75mm.....	<b>\$117.99B</b>
<b>FRENCH HORN</b>		
<b>W68855N</b>	17.50mm.....	<b>\$119.99</b>
<b>TROMBONE</b>		
<b>W68806BS</b>	25.40mm.....	<b>\$140.99</b>
<b>W68806BL</b>	25.40mm.....	<b>140.99</b>
<b>W68805BL</b>	25.73mm.....	<b>140.99</b>
<b>W68805AL</b>	25.73mm.....	<b>140.99</b>
<b>W68804 1/2 AL</b>	25.85mm.....	<b>140.99</b>

## TROMBONE/ EUPHONIUM

<b>W68804AL</b>	26.00mm.....	<b>\$140.99</b>
-----------------	--------------	-----------------

## BASS

<b>TROMBONE</b>		
<b>W68800AL</b>	27.42mm.....	<b>\$140.99</b>
<b>W68801AL</b>	27.11mm.....	<b>140.99</b>

## HERITAGE

<b>DW318000AL</b>	Bass Trombone.....	<b>\$253.99</b>
<b>DW31800AL</b>	Bass Trombone.....	<b>253.99</b>
<b>DW31801AL</b>	Bass Trombone.....	<b>253.99</b>
<b>DW31802AL</b>	Bass Trombone.....	<b>253.99</b>
<b>DW31802NAL</b>	Bass Trombone.....	<b>253.99</b>
<b>DW31803AL</b>	Trombone.....	<b>253.99</b>
<b>DW31804.5AL</b>	Trombone.....	<b>253.99</b>
<b>DW31804AL</b>	Trombone.....	<b>253.99</b>
<b>DW31804BL</b>	Trombone.....	<b>253.99</b>
<b>DW31804BS</b>	Trombone.....	<b>253.99</b>
<b>DW31805ABL</b>	Trombone.....	<b>253.99</b>
<b>DW31805AL</b>	Trombone.....	<b>253.99</b>
<b>DW31805BL</b>	Trombone.....	<b>253.99</b>
<b>DW31805BS</b>	Trombone.....	<b>253.99</b>
<b>DW31806AL</b>	Trombone.....	<b>253.99</b>
<b>DW31806BL</b>	Trombone.....	<b>253.99</b>
<b>DW31806BS</b>	Trombone.....	<b>253.99</b>
<b>DW31807CS</b>	Trombone.....	<b>253.99</b>
<b>DW31809BL</b>	Trombone.....	<b>253.99</b>
<b>DW31809BS</b>	Trombone.....	<b>253.99</b>
<b>DW318010CS</b>	Trombone.....	<b>253.99</b>
<b>DW318012CS</b>	Trombone.....	<b>253.99</b>

**DUE TO DOLLAR FLUCTUATION  
PRICES SUBJECT TO CHANGE**

**CALL YOUR REP FOR  
CURRENT PRICING**

# HOLTON



<b>7CHT351</b>	7C Trumpet.....	<b>\$58.00</b>
<b>7CHTT350</b>	7C AL Trombone.....	<b>70.00</b>
<b>12CHTT350</b>	12C AL Trombone.....	<b>70.00</b>
<b>18HTU355</b>	18 Tuba.....	<b>100.18</b>

## JET TONE MOUTHPIECES



## CLASSIC RE-ISSUE

<b>JETMF</b>	MF Classic Re-Issue Trumpet.....	<b>\$119.99B</b>
<b>JETT2B</b>	T2B Classic Re-Issue Trumpet.....	<b>119.99B</b>
<b>JETBM</b>	BM Classic Re-Issue Trombone.....	<b>119.99B</b>
<b>JETAH</b>	AH Classic Re-Issue Trumpet.....	<b>119.99B</b>
<b>JETSTB</b>	Studio B Classic Re-Issue Trumpet.....	<b>119.99B</b>
<b>JETSYMC</b>	Symphony C Classic Re-Issue Trumpet.....	<b>119.99B</b>
<b>JETDS</b>	DS Classic Re-Issue Trumpet.....	<b>119.99B</b>
<b>JETBC</b>	BC Classic Re-Issue Trumpet.....	<b>119.99B</b>

## MOUTHPIECE ADAPTERS



## DEG

<b>DEG34B</b>	Trombone – Bass T Bone.....	<b>\$20.00B</b>
<b>DEG36E</b>	Trombone – Euphonium.....	<b>20.00B</b>
<b>DEG38F</b>	Fr. Horn – Trumpet.....	<b>20.00B</b>
<b>DEG40C</b>	Cornet – Trumpet.....	<b>20.00B</b>

## SELMER

<b>S380TB</b>	Small Shank Tenor Trombone mouthpiece on Large Shank Bass Trombone. Silver Plated.....	<b>\$29.00</b>
<b>S385</b>	Single/Double Horn mouthpiece on Bach Marching Mellophone. Silver Plated.....	<b>32.00</b>
<b>S631</b>	Cornet mouthpiece on Trumpet. Silver Plated.....	<b>31.00</b>

## MOUTHPIECE EXTENSIONS

<b>S346</b>	For Trumpet mouthpiece.....	<b>\$37.00</b>
-------------	-----------------------------	----------------

## VISUALIZERS



<b>S1824</b>	For Trumpet, Cornet, Single/Double Horn mouthpiece.....	<b>\$30.00</b>
<b>S1825</b>	Trombone mouthpiece.....	<b>34.00</b>
<b>S1826</b>	Double for both Trumpet and Trombone Rims.....	<b>42.00</b>

## BRACE GUARD



Brace and lip protection for musicians. Quick, dependable, and reusable orthodontic shield.

**BG3** .....\$23.95

## MOUTHPIECE PATCHES



Helps prevent teeth marks.

- R1** Black (soft) Runyon .....\$5.70/2pk.
- R2** Clear (hard) .....5.45/2pk.
- MPGRC** Clear, Players .....3.75/2pk.
- MPGRS** Black, Players .....3.75/2pk.
- VMC6** Van Doren, 6 Pack .....17.00
- VMCX6** Van Doren, Thick, 6 Pack .....17.00
- YAC1090P** Small, Yamaha .....10.99/4
- YAC1093P** Med/Thin Yamaha .....10.99/4
- HMC153BO** Hollywood Mouthpiece Cushion  
0.3 mm black oval shape.....3.20/2pk.
- HMC153CO** Hollywood Mouthpiece Cushion  
0.3 mm clear oval shape .....3.20/2pk.
- HMC158BO** Hollywood Mouthpiece Cushion  
0.8 mm black oval shape.....3.20/2pk.
- HMC158CO** Hollywood Mouthpiece Cushion  
0.8 mm clear oval shape .....3.20/2pk.
- RMP01B** Black, Rico Reserve .....10.25/5pk.
- RMP01C** Clear, Rico Reserve.....10.25/5pk.

### SELMER CLARINET AND SAXOPHONE MOUTHPIECE PATCHES

- S1729** Asst. Patches .....\$5.35
- S1729B** Black Mouthpiece Patches .....5.35
- S1729C** Clear Mouthpiece Patches .....5.35

## DISPLAY CASES



- BACH**
- SDPMPC41** Holds 41 mouthpieces .....\$104.00
- SDPMPC19** Holds 19 mouthpieces .....77.00
- SDPIN56** Trombone insert (holds 6) .....12.00

## MORGAN BUMPER



Soft, pliable brace protecting material. Fluorescent colors.

- MBB** Blue.....\$28.95
- MBPU** Purple.....28.95
- MBCL** Clear.....28.95
- MBG** Green.....\$28.95
- MBPI** Pink.....28.95

## MOUTHPIECE POUCHES



- SS1828** Trumpet .....\$6.35
- SS1830** Trombone .....7.60
- SS1831** Tuba.....8.90

### BACH MOUTHPIECE POUCHES.

Flexible, rubber-like plastic.

- S1802** Trumpet .....\$8.50
- S1801** Cornet, Alto Horn.....8.50
- S1803** Tenor and Bass Trombone.....8.95
- S1804** Tuba and Sousaphone.....9.95
- SHLBL36** Large, Leather.....11.00

### BACH NYLON MOUTHPIECE POUCHES.

- S1891** Trumpet, Cornet, Horn.....\$10.00
- S1892** Trombone, Baritone.....11.00
- S1893** Tuba, Sousaphone.....12.00
- S1894** Quad Trumpet (holds four).....18.00

### NEOTECH PUCKER POUCH (Holds 2)

- PPS** Small .....\$8.25
- PPM** Medium.....9.50
- PPL** Large .....9.75

### BLACK LEATHER

- IA5** Trumpet .....\$5.40
- IA6** Trombone.....6.00
- IA7** Tuba .....7.50

## CHOP SAVER

### For Musicians With Lips

ChopSaver combines the goodness of herbs, aloe and Vitamin E in a rich shea and mango butter base kissed with the essential oils of citrus fruits. 100% natural, ChopSaver feels good from the moment you put it on.



- CHOP** .....\$4.95
- CHPR24** Display .....118.80
- CSGOLD** w/Sunblock.....4.95
- CHPS24** Sunblock Display .....118.80

## MOUTHPIECE PULLERS



### BOBCAT

Sturdy, portable mouthpiece puller with uniquely designed, adjustable jaws.

- BP105** .....\$70.20

### VALENTINO

- VJMP** .....\$98.45

## LIP SAVERS



Guaranteed protection for your lips during cold weather.

- S2428** Lip Ease, 30" Strip.....\$10.65

## POUCHES



### KIWI NECK PAK\*

- KINALB** Alto Sax.....\$21.99B
  - KINBRIB** Bari Sax .....21.99B
  - KINTENB** Tenor Sax .....21.99B
  - KINNYALB** New York Alto Sax .....19.99B
  - KINNYTENB** New York Tenor Sax .....19.99B
- (\*Add A for Blue Color)

Padded Mouthpiece Pouches with Velcro Closure.

- KIMPL** Tenor Sax, Bass Clarinet.....\$8.45B
- KIMPM** Clarinet, Alto Sax, Tuba.....8.45B
- KIMPS** Sop Sax, Trombone.....8.45B
- KIMPXL** Bari Sax.....8.45B
- KIMPXS** Trumpet, Fhorn.....8.45B

Neotech stores sax components. Fits in Bell. Red, Green, Gray, Royal Blue and Black.

- SAXPAC**.....\$17.95

Rovner Suedecloth Drawstring Bag.

- RMR** .....\$10.96

## AIR MAX BREATHER



Breathe your way to better performance

- AMB** .....\$12.95B

## DENIS WICK MUTES



### FIBER STRAIGHT

W5571 Trumpet.....	\$17.99
W5572 Trombone.....	23.99

### STRAIGHT

W5504 Trumpet.....	\$61.99
W5514 Cornet.....	61.99
W5520 D Trumpet/Eb Cornet.....	61.99
W5521 Piccolo Trumpet.....	61.99
W5522 Alto Trombone.....	72.99
W5505 Trombone.....	87.99
W5509 Bass Trombone.....	96.99
W5524 French Horn, Non Transposing.....	94.99
W5523 Baritone.....	146.99
W5513 Euphonium.....	222.99B
W5518 Tuba.....	398.99B



### CUP

W5531 Trumpet/Cornet.....	\$93.99
W5529 Trombone.....	124.99
W5533 Bass Trombone.....	141.99



### EXTENDING TUBE

W5506 Trumpet.....	\$77.99
W5507 Trombone.....	107.99
W5508 Bass Trombone.....	120.99

### PLUNGER

W5510 Trumpet.....	\$51.99
--------------------	---------



### PRACTICE

W5526 Trumpet/Cornet.....	\$67.99
W5534 D Trumpet/Eb Cornet.....	54.99B
W5532 Piccolo Trumpet.....	60.99
W5527 Trombone.....	87.99
W5528 Bass Trombone.....	96.99
W5512 Euphonium.....	214.99
W5530 French Horn.....	96.99

### STOPPING

W5525 French Horn.....	\$94.99
------------------------	---------

### WOODEN

W5551 Trumpet/Cornet.....	\$114.99
---------------------------	----------

PRICES SUBJECT TO CHANGE  
DUE TO DOLLAR FLUCTUATION

### BACH MUTE BAGS

Light and easy to carry mute bag has plenty of room for necessary mutes and stands.

S2012 Trombone mute bag.....	\$35.00
------------------------------	---------

### NEOTECH MUTE CASES

MCTBK Trumpet.....	\$18.95
MCTBBK Trombone.....	23.05

## SELMER MUTES



### BACH MUTES

Designed with Bach attention to quality, superior performance and precise acoustic detail. Made of rugged, high-impact polyethylene.

S1860 Trumpet/Cornet, straight.....	\$35.00
S1861 Trumpet/Cornet, cup.....	42.00
S1857 Trumpet/Practice.....	42.00
S1862 Trombone, straight.....	39.00
S1863 Trombone, cup.....	49.00

### STRADIVARIUS ULTRA

Stainless Steel flat bottom.

S2001 Trumpet straight.....	\$73.00
-----------------------------	---------

### STRADIVARIUS ELITE

Stainless steel bottom with patented tone intensifier.

SEL2004 Trombone straight.....	\$96.85
--------------------------------	---------



### SOFTONE MUTES

Whether you're practicing or performing, Softone™ mutes improve sound quality and create a variety of tones for trumpet, tenor trombone, and bass trombone. Made of soft, non-toxic neoprene, Softone™ mutes are lightweight and easy to use.

CG187 Trumpet.....	\$51.00
CG188S Small Bell Tenor Trombone.....	59.00
CG188L Large Bell Tenor Trombone.....	59.00
CG189S Small Bell Bass Trombone.....	65.00
CG189L Large Bell Bass Trombone.....	68.00

## ALESSI-VACCHIANO



### ALUMINUM MUTES

L3000 Straight, Trumpet/Cornet.....	\$43.00
L3002 Straight, Trombone.....	61.00

## HERCULES MUTE HOLDER

Ideal for most Cornet, Trumpet, Trombone and French Horn mutes, as well as many others keeping up to 4 mutes. Soft rubber covering on all rings for very quiet mute changes. Each ring swivels through 270 degrees to help provide the ideal personal set up. Attaches easily to the main shaft of most music stands and microphone stands with a (0.31"-1.18") tubing. A useful, general accessory tray is included.

HA100.....	\$36.00
------------	---------

## MUTE HOLDER



KM159.....	\$29.99
------------	---------

## JO RAL MUTES



### ALUMINUM STRAIGHT

S35101A Trumpet.....	\$48.60B
S35001A Trombone.....	71.90B
S34104A Bass Trombone.....	93.35B

### BRASS BOTTOM STRAIGHT

S35101B Trumpet.....	\$61.35B
S35105B Piccolo Trumpet.....	52.25B
S35001B Trombone.....	101.15B
S34104B Bass Trombone.....	121.45B

### COPPER BOTTOM STRAIGHT

S35101C Trumpet.....	\$56.70B
S35001C Trombone.....	102.45B

### ALUMINUM BUBBLE, WAH WAH

S35102A Trumpet.....	\$72.75B
S35003 Trombone.....	116.90B

### ALL COPPER BUBBLE, WAH WAH

S35102C Trumpet.....	\$121.45B
----------------------	-----------

### COPPER BOTTOM BUBBLE, WAH WAH

S342010C Flugelhorn.....	\$132.05B
--------------------------	-----------

### ALUMINUM BUCKET

S35104A Trumpet.....	\$78.85B
S35008S Small Tenor Trombone.....	119.15B
S35008L Large Tenor Trombone.....	127.90B
S34109 Bass Trombone.....	153.60B

### BRASS BOTTOM BUCKET

S35104B Trumpet.....	\$103.80B
----------------------	-----------

### COPPER BOTTOM BUCKET

S35104C Trumpet.....	\$96.65B
----------------------	----------

### TRI-TONE, CUP

S35103 Trumpet.....	\$59.05B
---------------------	----------

### PLUNGER

S35106 Trumpet.....	\$26.20
---------------------	---------

### ALUMINUM ADJUSTABLE CUP

S35006S Small Tenor Trombone.....	\$115.00B
S35006L Large Tenor Trombone.....	116.70B
S3410B7 Bass Trombone.....	145.35B

### PRACTICE

S35101P Trumpet.....	\$50.55B
S35105P Piccolo Trumpet.....	48.50B
S35001P Tenor Trombone.....	74.55B
S3360P Horn.....	86.70B

### HORN NON-TRANSPOSING

S33601A Aluminum.....	\$103.20B
S3360C All Copper.....	130.80B

## MUTE HOLDERS

MHTPM Trumpet Manhasset.....	\$14.86
MHTBM Trombone Manhasset.....	21.60

# MUTES

## TOM CROWN



### TRUMPET MUTES

<b>TC1</b>	All Aluminum .....	<b>\$62.00</b>
<b>TC2</b>	Aluminum with Brass End .....	<b>67.00</b>
<b>TC3</b>	Aluminum with Copper End .....	<b>67.00</b>
<b>TC3C</b>	All Copper Straight Mute .....	<b>72.00</b>
<b>TC11</b>	A Model, Straight Mute .....	<b>62.00</b>
<b>TC15</b>	Cup Mute For Trumpet .....	<b>67.00</b>
<b>TC17</b>	Brass Straight Mute .....	<b>70.00</b>
<b>TC18</b>	Copper Cup Mute .....	<b>80.00</b>
<b>TC19</b>	Copper Piccolo, Straight Mute .....	<b>68.00</b>
<b>TC21</b>	All Copper for C Trumpet .....	<b>70.00</b>
<b>TC22</b>	All Aluminum for C Trumpet .....	<b>60.00</b>
<b>TC25</b>	All Aluminum Cup Mute for Eb/D Trumpet .....	<b>66.00</b>
<b>TC26</b>	All Aluminum Cup Straight Mute for D Trumpet .....	<b>62.00</b>
<b>TC29</b>	All Aluminum for C Trumpet .....	<b>67.00</b>
<b>TC31</b>	Trumpet Practice Mute .....	<b>61.00</b>
<b>TCGEMA</b>	Gemini All Aluminum Straight .....	<b>66.00</b>
<b>TCGEMC</b>	Gemini Aluminum Straight/Copper End .....	<b>71.00</b>



<b>TC5</b>	Wah-Wah Type Mute for Bb-C Trumpet .....	<b>\$74.00</b>
<b>TC5C</b>	All Copper Wah-Wah Trumpet .....	<b>98.00</b>
<b>TC6</b>	Wah-Wah Type Mute for Piccolo Trumpet .....	<b>58.00</b>



<b>TC4</b>	Piccolo Trumpet Straight Mute .....	<b>\$50.00</b>
<b>TC6C</b>	Piccolo Trumpet, Straight Mute, Copper End .....	<b>59.00</b>



### TROMBONE MUTES

<b>TC7</b>	Tenor Trombone - All Aluminum .....	<b>\$78.00</b>
<b>TC8</b>	Tenor Trombone - Aluminum with Copper End .....	<b>98.00</b>
<b>TC9</b>	Bass Trombone - All Aluminum .....	<b>83.00</b>
<b>TC9C</b>	Bass Trombone - Aluminum with Copper End .....	<b>100.00</b>
<b>TC16</b>	Cup Mute For Trombone .....	<b>86.00</b>

### FRENCH HORN

#### Lacquered Brass with Leather Holding Loop:

<b>TC10</b>	Transposing French Horn Mute .....	<b>\$103.00</b>
-------------	------------------------------------	-----------------

## HARMON



### WOW WOW

Harmon "Wow Wow" for Trumpets and Cornets. (With sliding tube and cup).

<b>BMUTE</b>	.....	<b>\$57.00</b>
<b>LMUTE</b>	Copper .....	<b>92.00</b>
<b>AMUTE</b>	B Mute without Cup .....	<b>47.00</b>
<b>CAMUTE</b>	Trumpet - Aluminum Wow Wow - Symphonic .....	<b>61.00</b>
<b>CCMUTE</b>	Trumpet - Copper - Wow Wow - Symphonic .....	<b>77.00</b>
<b>DAMUTE</b>	Trumpet - Alum/Alum - Wow Wow - Bubble .....	<b>61.00</b>
<b>DCMUTE</b>	Trumpet - Copper - Wow Wow - Bubble .....	<b>77.00</b>

Harmon "Wow Wow" for Trombones.

<b>EMUTE</b>	.....	<b>\$90.00</b>
--------------	-------	----------------

### TRIPL PLAY TRUMPET

<b>JIMUTE</b>	.....	<b>\$64.00</b>
<b>GIMUTE</b>	Barrel Shaped Straight Mute .....	<b>39.00</b>
<b>HIMUTE</b>	Hat Mute .....	<b>29.00</b>
<b>J2AMUTE</b>	Trumpet - Aluminum - Adjustable Cup .....	<b>71.00</b>
<b>J2CMUTE</b>	Trumpet - Alum/Copper - Adjustable Cup .....	<b>92.00</b>

### TRIPL PLAY TENOR TROMBONE

<b>J3MUTE</b>	.....	<b>\$78.00</b>
---------------	-------	----------------

(Combination of Styles, G3 Mute & H3 Mute)

<b>G3MUTE</b>	Barrel Shaped Straight .....	<b>\$57.00</b>
<b>H3MUTE</b>	Hat Mute .....	<b>36.00</b>

### FRENCH LINE STRAIGHT MUTES

<b>X1MUTE</b>	Barrel Shape for Trumpet or Cornet .....	<b>\$39.00</b>
<b>X2MUTE</b>	Streamliner for Trumpet or Cornet .....	<b>39.00</b>
<b>G2AMUTE</b>	Trumpet - Alum/Alum - Straight - French Style .....	<b>51.00</b>
<b>G2CMUTE</b>	Trumpet - Alum/Copper - Straight - French Style .....	<b>61.00</b>

## WINDY CITY



### TROMBONE

<b>AATTSM</b>	All Aluminum Tenor Trombone Straight .....	<b>\$64.00</b>
<b>BBTSM</b>	Brass Bottom Tenor Trombone Straight .....	<b>74.00</b>
<b>CBTSM</b>	Copper Bottom Tenor Trombone Straight .....	<b>74.00</b>
<b>AABTSM</b>	All Aluminum Bass Trombone Straight .....	<b>76.00</b>
<b>BBBTSM</b>	Brass Bottom Bass Trombone Straight .....	<b>82.00</b>
<b>CBBTSM</b>	Copper Bottom Bass Trombone Straight .....	<b>82.00</b>
<b>PTTSM</b>	Practice Tenor Trombone Straight .....	<b>70.00</b>
<b>PBTSM</b>	Practice Bass Trombone Straight .....	<b>80.00</b>
<b>TTACM</b>	Tenor Trombone Adjustable Cup .....	<b>78.00</b>
<b>BTACM</b>	Bass Trombone Adjustable Cup .....	<b>99.00</b>
<b>TTWW</b>	Tenor Trombone Wah-Wah .....	<b>81.00</b>
<b>BTWW</b>	Bass Trombone Wah-Wah .....	<b>84.00</b>

## SAX



### Original Swab Sax Mutes Black

<b>OSSAXMBK</b>	Alto Sax .....	<b>\$15.95</b>
<b>OSSAXMTBK</b>	Tenor Sax .....	<b>17.95</b>

### NEOTECH

<b>STFA</b>	Alto Sax .....	<b>\$9.95</b>
<b>STFT</b>	Tenor Sax .....	<b>10.95</b>
<b>STFC</b>	Combo Pack .....	<b>19.95</b>

# WINDY CITY MUTES



## All Aluminum Straight Trumpet Mute

Provides a brilliant, muted sound that professional musicians love. Easy-blowing with outstanding intonation and response, making it suitable for any venue.

AASTM .....\$49.95



## All Aluminum Three In One Trumpet Mute

Use it as a straight mute, a cup mute, or a plunger. It performs superbly in each function.

AATIO .....\$59.95



## Brass-Bottom Straight Trumpet Mute

Expect a warm, cozy sound that lends itself to small settings.

BBSTM .....\$54.95



## Practice Straight Trumpet Mute

All-aluminum but with a polymer finish that drastically reduces volume while maintaining tone quality and response. For practice sessions or discreet warm-up.

PSTM .....\$59.95



## Trumpet All-Aluminum Ball Mute

Metal thickness is held to a very close tolerance. This mute produces a very generous BUZZ. Jazz musicians love it.

AABM .....\$69.95



## Aluminum Wah Wah

AASWW .....\$59.95



## All-Aluminum Piccolo Trumpet Straight Mute

Elegant design and superior tone quality throughout the range of sound make this Windy City puppy a must buy. It is available with all the different bottoms allowing for different sound characteristics, and thus freedom of artistic expression.

AAPSTM .....\$39.95



## Piccolo Straight Mute Practice

All-aluminum with a polymer finish that drastically reduces volume while maintaining tone quality and response. For practice sessions or discreet warm-up.

PSMP .....\$49.95

## Trumpet All-Copper Ball Mute

Richer, more bite, a shade darker in tone than its aluminum counterpart, it produces the same generous BUZZ.

CBM .....\$84.95



## Student Trumpet Mute Practice

This Windy City practice mute is affordable to all. Expertly-made it is free-blowing and plays in tune in all registers. Aluminum but with a polymer finish that greatly reduces volume.

STMP .....\$39.95



## Student Trumpet Mute Brass Bottom

This expertly-made mute is affordable to all. It is free-blowing and plays in tune in all registers. Has a very large market.

STMBB .....\$34.95



## Student Trumpet Mute All-Aluminum

This expertly-made mute is affordable to all. It is free-blowing and plays in tune in all registers.

STMAA .....\$29.95



## Student Trumpet Mute Copper-Bottom

This expertly-made mute is affordable to all. It is free-blowing and plays in tune in all registers.

STMCB .....\$34.95



## Plunger Trumpet Mute

Easy-grip plunger mute is all-Aluminum, has superb sound and is easier to hold than the typical plunger mute. Lined with a neoprene rubber rim to prevent vibration, it comes in a sparkling brushed-silver finish. Has excellent GROWL!

PTM .....\$38.95



## Trumpet Stationary Cup Mute All-Aluminum

This professionally-designed mute is tuned to be free-blowing in all registers. Has good range. Sound quality is best described as rich, abundant, fuzzy. Suitable for a variety of playing styles.

SCTMAA .....\$69.95



## Trumpet Stationary Cup Mute Copper Cup

Free-blowing in all registers with a darker richness in sound than the all-Aluminum.

SCTMCC .....\$79.50



## Trumpet Adjustable Cup Mute

By moving the beehive designed cup to different positions, new dimensions in sounds and tonal flexibility are achieved. Cup won't drop off. A specially formulated rubber lines the rim of the cup, preventing vibration. A pleasure to use and hear.

ACTM .....\$69.95

# MUTEC MUTES



## TRUMPET STRAIGHT

<b>MHT107</b>	Round – Aluminum Bottom Stock.....	<b>\$52.00</b>
<b>MHT108</b>	Round – Copper Bottom Stock.....	<b>62.00</b>
<b>MHT109</b>	Round – All Copper Stock.....	<b>69.00</b>
<b>MHT110</b>	Round – Black Polymer Stock.....	<b>24.00</b>
<b>MHT111</b>	Round – Brass Bottom Stock.....	<b>69.00</b>
<b>MHT115</b>	Fiber – White Oak Bottom Stock.....	<b>44.00</b>
<b>MHT116</b>	Fiber – Walnut Bottom Stock.....	<b>44.00</b>

## TRUMPET WAH-WAH

<b>MHT120</b>	Traditional – Aluminum Stock.....	<b>\$58.00</b>
<b>MHT121</b>	Traditional – Copper Stock.....	<b>73.00</b>
<b>MHT123</b>	Large – Aluminum Stock.....	<b>58.00</b>
<b>MHT124</b>	Large – Copper Stock.....	<b>73.00</b>
<b>MHT130</b>	Bubble – Aluminum Stock.....	<b>60.00</b>
<b>MHT131</b>	Bubble – Copper Stock.....	<b>75.00</b>

## TRUMPET CUP

<b>MHT145</b>	Round – Adjustable Aluminum Stock.....	<b>\$72.00</b>
<b>MHT146</b>	Round – Adjustable Copper Stock.....	<b>92.00</b>
<b>MHT147</b>	Round – Adjustable Brass Stock.....	<b>103.00</b>
<b>MHT148</b>	Round – Adjustable Black Polymer.....	<b>42.00</b>

## TRUETONE TRUMPET

<b>MHT113</b>	Straight – Blue Polymer Stock.....	<b>\$18.00</b>
<b>MHT114</b>	Straight – Red Polymer Stock.....	<b>18.00</b>
<b>MHT149</b>	Cup – Scalloped – Snap Adj. Polymer.....	<b>30.00</b>
<b>MHT162</b>	Practice – Black Polymer Stock.....	<b>30.00</b>

## TRUETONE TROMBONE

<b>MHT213</b>	Straight – Blue Polymer Stock.....	<b>\$25.00</b>
<b>MHT214</b>	Straight – Red Polymer Stock.....	<b>25.00</b>

## METAL PRACTICE

<b>MHT161</b>	Trumpet – Practice – Aluminum Stock.....	<b>\$42.50</b>
<b>MHT164</b>	Trumpet – Warmup – Round Aluminum.....	<b>47.50</b>
<b>MHT264</b>	Trombone – Warmup – Tenor Round Aluminum.....	<b>55.00</b>

## OTHER

<b>MHT160</b>	Trumpet – Plunger – Black Rubber Stock.....	<b>\$30.00</b>
<b>MHT260</b>	Trombone – Plunger – Black Rubber Stock.....	<b>37.50</b>

## TROMBONE STRAIGHT

<b>MHT207</b>	Round – Aluminum Bottom Stock.....	<b>\$77.00</b>
<b>MHT208</b>	Round – Copper Bottom Stock.....	<b>97.00</b>
<b>MHT210</b>	Round – Black Polymer Stock.....	<b>35.00</b>



## EUPHONIUM

<b>MHT302</b>	Straight – Round – Aluminum Bottom Stock.....	<b>\$135.00</b>
---------------	---	-----------------

## TUBA

<b>MHT402</b>	Straight – Round – Aluminum Bottom Stock.....	<b>\$325.00</b>
---------------	---	-----------------

# YAMAHA



<b>MUTR105</b>	Trumpet; straight; aluminum.....	<b>\$62.99</b>
<b>MUTR125</b>	Trumpet; straight; alum. w/copper base.....	<b>69.99</b>
<b>MUTR13C</b>	Trumpet; cup; aluminum.....	<b>93.99</b>
<b>MUSL165</b>	Trombone; straight; alum. w/copper base.....	<b>119.99</b>

# BELMONTE



<b>TPM1</b>	Trumpet Straight.....	<b>\$34.25</b>
<b>TPM2</b>	Straight (Black).....	<b>42.25</b>
<b>TPM3</b>	Trumpet wow-wow.....	<b>42.25</b>
<b>TPM5</b>	Trumpet cup.....	<b>42.20</b>
<b>TBM1</b>	Straight (Trombone).....	<b>47.50</b>

# YAMAHA SILENT BRASS



<b>SB7XC</b>	Silent Brass System for Trumpet: consists of PM7X and STX; includes MP3 Cable.....	<b>\$229.99*</b>
<b>SB6XC</b>	Silent Brass System for Flugelhorn: consists of PM6X and STX; includes MP3 Cable.....	<b>239.99*</b>
<b>SB5XC</b>	Silent Brass System for Trombone: consists of PM5X and STX; includes MP3 Cable.....	<b>249.99*</b>
<b>SB3XC</b>	Silent Brass System for French Horn: consists of PM3X and STX; includes MP3 Cable.....	<b>259.99*</b>
<b>PM7X</b>	Trumpet: Silent Brass, Mute only with cord.....	<b>139.99*</b>
<b>PM6X</b>	Flugelhorn: Silent Brass, Mute only with cord.....	<b>149.99*</b>
<b>PM5X</b>	Trombone: Silent Brass, Mute only with cord.....	<b>159.99*</b>
<b>PM3X</b>	Horn: Silent Brass, Mute only with cord.....	<b>169.99*</b>

\* = CALL FOR DEALER COST

# BLESSING

SINCE 1906



Great Grandpa Emil came from Germany and started it all in 1906. Three generations of the family followed, making Blessing a household name in the world of brass instruments.

Based in Elkhart, Indiana and operated by folks obsessed with quality, Blessing is flourishing!

## Trumpets

### BTR-1277 (student)

There's nothing student about the BTR-1277 except the price! An improved bell, leadpipe, and tuning slide offer the color and response of a professional horn with built-in reliability.

Model	List	Description
BTR-1277	\$1,050	Bb Trumpet, .460" bore, 1st valve hook, stainless steel pistons, 3rd valve stop, lacquered brass, 7C mouth piece, C-125 plastic case.
BTR-1277S	\$1,150	Same as BTR-1277 with silver plating.

### BTR-1460 (intermediate) *(BTR-1460S pictured above)*

The BTR-1460 features the newly designed #24 bell for players who want a more open, broad sound. The excellent feel and responsiveness of the hand-lapped Monel pistons allow flexibility while maintaining a sturdy foundation.

Model	List	Description
BTR-1460	\$1,610	Bb Trumpet, .460" bore, 1st valve hook, Monel pistons, red brass lead pipe, nickel mouthpiece receiver, 7C mouthpiece, C-135 wood case.
BTR-1460S	\$1,760	Same as BTR-1460 with silver plating
BTR-1460G	\$1,810	Same as BTR-1460 with silver plating and gold plated trim.

## Cornets

### BCR-1230

When the BCR-1230 was taken to the 2010 TMEA conference in San Antonio it was met with good ole' Texas scrutiny from the heart of cornet country. It stood tall to the test and was proclaimed by band directors, dealers and private teachers as the best playing cornet in its class. The combination of stainless steel pistons, a two-piece hand-hammered bell, and new bell style make this an instrument that impresses even the most serious cornet aficionado.

Model	List	Description
BCR-1230	\$1,180	Cornet, .460" bore, 1st valve hook, stainless steel pistons, double wing valve guide, lacquered brass, 7C mouthpiece, C-121 case.
BCR-1230S	\$1,290	Same as BCR-1230 with silver plating.





## Flugelhorns

### BFH-1541T *(BFH-1541RT pictured above)*

The BFH-1541T Flugelhorn is another classic Blessing design that, based on the recommendations of Cliff Blackburn, we have updated for today's players. A reduction in the diameter of the first branch has dramatically improved intonation and we upgraded the profile of the valve block for an aesthetically more attractive look. It is an instrument that provides players with the dark, mellow qualities of sound that are expected from a flugelhorn. The additional versatility offered by the optional seamless stress-free, one-piece copper bell creates an instrument that will cater to a musician's needs.

Model	List	Description
BFH-1541T	\$2,580	Flugelhorn, .460" bore, 6" bell, 3rd valve slide trigger, Monel pistons, lacquered brass, 3FL mouthpiece, C-154 case.
BFH-1541RT	\$2,500	Flugelhorn, .460" bore, 6" one-piece red copper bell, 3rd valve slide trigger, Monel pistons, lacquered brass, 3FL mouthpiece, C-154 case.
BFH-1541TS	\$2,730	Same as BFH-1541T with silver plating.

## Trombones

### BTB-1280

The BTB-1280 is a straight tenor trombone designed for ease of play and built to endure the inevitable bumps and bruises of a busy student lifestyle. The smooth action of the hand slide and the 8" two-piece yellow brass bell provide the student player with a big, bold sound.

Model	List	Description
BTB-1280	\$1,130	Trombone, .500" bore, 8" Bell, lacquered brass, 12C mouthpiece, C-128 plastic case.
BTB-1280S	\$1,340	Same as BTB-1280 with silver plating.

### BTB-88-O

The BTB-88O is the Blessing classic that stands among the most prominent and popular intermediate rotor trombones in the world. The .547" bore and 8½" bell flair (available in either two-piece yellow brass or seamless copper), coupled with the F rotor attachment, make this horn a strong partner for the advanced player.

Model	List	Description
BTB-88-O	\$2,560	Trombone, .547" large bore, F rotor, open wrap, 8 1/2" bell, lacquered brass, 6.5-AL large shank mouthpiece, C-88 case.
BTB-88-OS	\$2,770	Same as BTB-88-O with silver plating.
BTB-88-OR	\$2,690	Trombone, .547" large bore, F rotor, open wrap, 8 1/2" red copper bell, lacquered brass, 6.5-AL large shank mouthpiece, C-88 case.

## PALATINO BAND INSTRUMENTS



**WI806FS** Flute .....\$338.55



**WI801C** Clarinet .....\$286.90



**WI815TP** Trumpet .....\$352.75



**WI816TB** Trombone .....\$418.55



**WI819A** Alto Sax .....\$799.35

**WI818S** Soprano Sax .....799.15

## BUGLES



U.S. regulation bugle. Made of highly polished brass.

**BU14** U.S. G/F.....\$190.00B

**BU14NS** U.S. G/F Nickel Silver.....197.50B

**4500** Regiment, G/F .....109.95

**BU1440** Mouthpiece .....23.50B

**BUBAG** Padded Bag .....25.85B

## EMPEROR BAND INSTRUMENTS



Educator series, high F# key, brass body, hard lacquered finish, forged brass keys, ABS plush lined case.

**EAS403** Alto Sax .....\$825.00

Brass body, high F# key, forged brass keys, hard lacquered finish, ABS plush lined case.

**ETS303** Tenor Sax .....\$1025.00

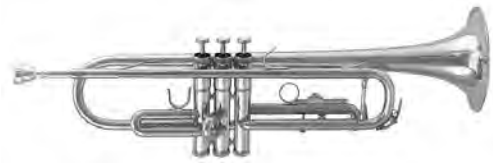

ML bore, adjustable finger ring at 3<sup>rd</sup> valve, silver plated brass mouthpiece, 2 water valves, golden brass mouth pipe with silver plated trim, thumb rest at 1<sup>st</sup> valve, brass body, hard lacquered body, stainless steel valves for durability, ABS case.

**ETR303** Trumpet, Signature Model.....\$350.00



Silver plated head joint, body and keys, cleaning rod and cloth, alloy springs, plush lined French style wood case, E key.

**EFL302E** Flute .....\$335.00



Ebonite body, silver plated keys and mechanics, ligature, ABS Plush lined molded case, cork grease, mouthpiece, cleaning swab, cap.

**ECB428** Clarinet .....\$360.00



12.7mm bore, nickel silver trim, 8.5" brass bell, hard lacquered finish, brass body, lightweight case with backpack straps.

**ETT238** Trombone .....\$460.00

# BAND INSTRUMENT CASES



Molded plastic cases combining durability and quality at affordable prices.

<b>D15808E</b>	B Foot Flute & Piccolo .....	<b>\$118.60</b>
<b>D10809E</b>	Flute .....	<b>58.80</b>
<b>D27910V</b>	Clarinet .....	<b>69.15</b>
<b>TKL8690</b>	Flute .....	<b>57.15</b>
<b>TKL8691</b>	Clarinet .....	<b>76.15</b>
<b>TKL8692</b>	Trumpet .....	<b>133.35</b>
<b>TKL8693</b>	Alto Sax .....	<b>133.35</b>
<b>TKL8694</b>	Tenor Sax .....	<b>152.45</b>
<b>D651210V</b>	Trumpet .....	<b>121.10</b>
<b>D681213V</b>	Alto Sax .....	<b>167.85</b>
<b>D671212V</b>	Cornet .....	<b>121.10</b>
<b>D70818V</b>	Trombone(8" bell) .....	<b>194.45</b>
<b>D28911E</b>	Oboe .....	<b>69.15</b>
<b>D72926V</b>	French Horn .....	<b>351.95</b>
<b>D16646E</b>	Piccolo .....	<b>41.50</b>
<b>1215V</b>	Bari Sax .....	<b>630.00</b>

**PALATINO FEATHERWEIGHT THERMOPLASTIC**

<b>CW041FL</b>	Flute .....	<b>\$51.25</b>
<b>CW041CL</b>	Clarinet .....	<b>67.45</b>
<b>CW041TP</b>	Trumpet .....	<b>87.64</b>
<b>CW041SA</b>	Alto Sax (Shaped) .....	<b>105.80</b>
<b>CW041ST</b>	Tenor Sax .....	<b>134.80</b>
<b>CW041FH</b>	French Horn .....	<b>139.85</b>

**ACCESSORIES**

<b>HE62</b>	Case ID Tacs, Package of 48 .....	<b>\$76.25</b>
<b>CSLBK</b>	Neotech, Case Sling, Black .....	<b>29.95</b>
<b>SOSBK</b>	Neotech, Case Strap, Black .....	<b>38.30</b>

## SKB CASES



These cases offer the best in instrument protection.

<b>SKB130</b>	Contoured Trumpet .....	<b>\$139.99</b>
<b>SKB140</b>	Alto Sax Shaped .....	<b>160.99</b>
<b>SKB150</b>	Tenor Sax Shaped .....	<b>197.99</b>
<b>SKB440</b>	Alto Sax Shaped, Pro Model .....	<b>212.99</b>
<b>SKB450</b>	Tenor Sax Shaped, Pro Model .....	<b>249.99</b>
<b>SKB340</b>	Alto Sax, Rectangular .....	<b>155.99</b>
<b>SKB350</b>	Tenor Sax, Rectangular .....	<b>186.99</b>
<b>SKB310</b>	Flute B Foot Joint .....	<b>77.99</b>
<b>SKB312</b>	Flute C Foot Joint .....	<b>77.99</b>
<b>SKB320</b>	Clarinet Rectangular .....	<b>93.99</b>
<b>SKB330</b>	Trumpet Rectangular .....	<b>139.99</b>
<b>SKB360</b>	Trombone .....	<b>186.99</b>
<b>SKB315</b>	Oboe .....	<b>93.99</b>
<b>SKB325</b>	Cornet .....	<b>139.99</b>
<b>SKB462</b>	Universal Tenor Trombone .....	<b>264.99</b>
<b>SKB370</b>	French Horn .....	<b>228.99</b>
<b>SKB375</b>	Euphonium .....	<b>332.99</b>
<b>SKB380</b>	Sousaphone .....	<b>764.99</b>
<b>SKB385W</b>	Tuba, Mid Size, w/wheels .....	<b>873.99</b>
<b>SKB390W</b>	Tuba, Large, w/wheels .....	<b>909.99</b>
<b>SKB455W</b>	Bari Sax w/wheels .....	<b>545.99</b>



Streamlined hard shell case covered in heavy vinyl, plushlined. Made in USA.

<b>7158W</b>	Clarinet .....	<b>\$106.80</b>
<b>7159W</b>	Clarinet, Carry All .....	<b>137.70</b>
<b>7160W</b>	Cornet .....	<b>145.40</b>
<b>7161W</b>	Trumpet, will hold mute .....	<b>157.30</b>
<b>7162W</b>	Alto Sax .....	<b>213.70</b>
<b>7163W</b>	Tenor Sax .....	<b>277.70</b>

### BACK GROUND BRASS

<b>1200V</b>	Bell Front Baritone Case .....	<b>\$454.20</b>
<b>1201V</b>	Student Euphonium Case .....	<b>502.60</b>
<b>1203V</b>	Reverse Top Action Tuba Case .....	<b>1225.00</b>
<b>1204V</b>	Med. F Tuba Case w/wheels .....	<b>1170.95</b>
<b>1205V</b>	Small Tuba Case w/wheels .....	<b>949.75</b>
<b>1207V</b>	Medium Tuba Case w/wheels .....	<b>1127.00</b>
<b>1209V</b>	Large Tuba Case w/wheels .....	<b>1225.00</b>
<b>1199V</b>	Sousaphone Case w/wheels .....	<b>855.75</b>
<b>1197V</b>	Rotational Tuba Vault .....	<b>1225.00</b>

### Factory Drop Ship



### TKL ZERO GRAVITY

With Shoulder Straps

<b>TKL6190</b>	Flute .....	<b>\$37.75</b>
<b>TKL6191</b>	Clarinet .....	<b>67.10</b>
<b>TKL6192</b>	Trumpet .....	<b>92.10</b>
<b>TKL6193</b>	Alto Sax .....	<b>102.05</b>
<b>TKL6194</b>	Tenor Sax .....	<b>128.55</b>
<b>TKL6195</b>	Trombone .....	<b>163.00</b>



KBFA51

### KACES WEIGHTLESS

With Shoulder Straps

<b>KBFFL1</b>	Flute .....	<b>\$52.70</b>
<b>KBFCL1</b>	Clarinet .....	<b>63.85</b>
<b>KBFTP1</b>	Trumpet .....	<b>91.55</b>
<b>KBFA51</b>	Alto Sax .....	<b>121.00</b>
<b>KBFTS1</b>	Tenor Sax .....	<b>141.30</b>
<b>KBFTM1</b>	Trombone .....	<b>149.85</b>
<b>KBFTMF2</b>	Trombone, F Attachment .....	<b>162.30</b>

### KACES POLYFOAM

With Shoulder Straps

<b>KBFBAS2</b>	Alto Sax Case, Dark Blue .....	<b>\$121.00</b>
<b>KBFRAS4</b>	Alto Sax Case, Dark Red .....	<b>121.00</b>
<b>KBFBCL2</b>	Clarinet Case, Dark Blue .....	<b>63.85</b>
<b>KBFPCL3</b>	Clarinet Case, Purple .....	<b>63.85</b>
<b>KBFRCL4</b>	Clarinet Case, Dark Red .....	<b>63.85</b>
<b>KBFBTP2</b>	Trumpet Case, Dark Blue .....	<b>91.55</b>
<b>KBFRTP4</b>	Trumpet Case, Dark Red .....	<b>91.55</b>
<b>KBFBFL2</b>	Flute Case, Dark Blue .....	<b>52.70</b>
<b>KBFPFL3</b>	Flute Case, Purple .....	<b>52.70</b>
<b>KBFRFL4</b>	Flute Case, Dark Red .....	<b>52.70</b>

## INSTRUMENT BAGS



### TKL

Padded Nylon Bags

<b>B4792</b>	Trumpet .....	<b>\$45.25</b>
<b>B4793</b>	Alto Sax .....	<b>49.10</b>
<b>B4794</b>	Tenor Sax .....	<b>52.80</b>
<b>B4795</b>	Trombone .....	<b>90.65</b>
<b>TKL98247</b>	Dlx. Flute .....	<b>41.50</b>
<b>TKL98248</b>	Dlx. TPT .....	<b>83.15</b>
<b>TKL98249</b>	Dlx. Sop Sax .....	<b>162.65</b>
<b>TKL98250</b>	Dlx. Sop Sax .....	<b>83.15</b>
<b>TKL98251</b>	Dlx. Alto .....	<b>94.45</b>
<b>TKL98252</b>	Dlx. Tenor .....	<b>132.30</b>
<b>TKL98253</b>	Dlx. T-Bone .....	<b>151.55</b>
<b>TKL98254</b>	Dlx. F Horn .....	<b>132.30</b>



### SKB SOFT CASES

<b>SKBSC325</b>	Cornet Rectangular .....	<b>\$103.99</b>
<b>SKBSC330</b>	Trumpet Rectangular .....	<b>103.99</b>
<b>SKBSC340</b>	Alto Sax Rectangular .....	<b>120.99</b>
<b>SKBSC350</b>	Tenor Sax Rectangular .....	<b>120.99</b>



### KACES CASE COVERS

<b>KCCL4B</b>	Clarinet, Blue .....	<b>\$59.60</b>
<b>KCCL2PI</b>	Clarinet, Pink .....	<b>59.60</b>
<b>KCFL3B</b>	Flute, Blue .....	<b>46.70</b>
<b>KCFL1PI</b>	Flute, Pink .....	<b>46.70</b>



### PALATINO Cordura Nylon

<b>CW600SA</b>	Alto Sax .....	<b>\$65.15</b>
<b>CW600ST</b>	Tenor Sax .....	<b>90.80</b>
<b>CW600TB</b>	Trombone .....	<b>105.30</b>
<b>CW600TP</b>	Trumpet .....	<b>56.80</b>

## SELMER GIG BAGS

All bags are constructed from quality black leather and very generously padded and plush lined for maximum instrument protection.

<b>SHLBL1</b>	Trumpet .....	<b>\$199.50</b>
<b>SHLBL9</b>	Triple Trumpet .....	<b>420.00</b>
<b>S788</b>	Student Case Strap .....	<b>8.30</b>

## MANHASSET STANDS



Convert the base of any folding or concert music stand into a stand for trumpet, flute, piccolo, oboe, clarinet, recorder.

<b>MAN1400</b>	Stand Adaptor .....	<b>\$38.88</b>
<b>MAN1420</b>	Dual Peg Adaptor .....	<b>15.69</b>
<b>MAN1430</b>	Piccolo Peg .....	<b>13.65</b>
<b>MAN1440</b>	Flute Peg.....	<b>13.65</b>
<b>MAN1450</b>	Clarinet Peg.....	<b>14.67</b>
<b>MAN1470</b>	Oboe Peg.....	<b>14.67</b>
<b>MAN1480</b>	Trumpet/Cornet Peg.....	<b>14.67</b>

## K&M STANDS



Create your own stand with these K & M Bases and Pegs.

### BASES & PEGS

<b>KM1777</b>	Single Peg Base .....	<b>\$16.99</b>
<b>KM1771</b>	Four Peg Base .....	<b>27.99</b>
<b>KM17738</b>	Oboe Peg.....	<b>20.99</b>
<b>KM17786</b>	Flute Peg, Plastic .....	<b>15.95</b>
<b>KM17741</b>	Eb Clarinet Peg.....	<b>19.95</b>
<b>KM15294</b>	Soprano Sax Peg.....	<b>19.99</b>
<b>KM17782</b>	Flute/Piccolo Peg.....	<b>15.95</b>
<b>KM17788</b>	Flute Peg, 18mm.....	<b>15.95</b>
<b>KM17731</b>	English Horn Peg.....	<b>20.95</b>
<b>KM15224</b>	A or Bb Clarinet Peg.....	<b>19.95</b>
	Holder for instrument pegs. Includes 3 adaptors (for tubes).	
<b>KM14301</b>	Peg Holder.....	<b>\$14.99</b>

## HAMILTON STANDS



KB5PB

Custom Design Your Stands

<b>KB1PB</b>	Single Peg Base.....	<b>\$13.00</b>
<b>KB5PB</b>	Five Peg Base.....	<b>21.00</b>
<b>KBFSF</b>	Flute Peg, Small.....	<b>14.00</b>
<b>KBCP</b>	Clarinet Peg.....	<b>11.00</b>
<b>KBOP</b>	Oboe Peg.....	<b>17.00</b>
<b>KBSP</b>	Soprano Sax Peg.....	<b>22.00</b>
<b>KBTP</b>	Trumpet Peg.....	<b>21.00</b>
<b>KBEHP</b>	English Horn Peg.....	<b>17.00</b>
<b>KBPSF</b>	Piccolo Peg, Small.....	<b>16.00</b>



### SYSTEM X

System X is the most versatile and customizable instrument stand ever created. Adjustable belt rests, body rests, bore sizes make sure any instrument will fit each stand to perfection.

<b>KB7000</b>	Trumpet/Cornet/Flugelhorn/Soprano Sax .....	<b>\$39.99</b>
<b>KB7010</b>	Trombone.....	<b>58.99</b>
<b>KB7020</b>	Alto/Tenor Sax.....	<b>49.99</b>
<b>KB7022</b>	Alto/Tenor Sax Double.....	<b>85.99</b>
<b>KB7030</b>	Baritone Sax Stand.....	<b>69.99</b>
<b>KB7090</b>	Peg Base w/One Peg.....	<b>19.99</b>
<b>KB7901</b>	Trumpet/Cornet/Flugelhorn/Soprano Sax (Peg only).....	<b>35.99</b>
<b>KB7921</b>	Connector Piece.....	<b>9.99</b>

## DEG TUBA REST



Handy Tuba Rest

<b>A18MC100</b> .....	<b>\$115.00</b>
-----------------------	-----------------

## HERCULES STANDS

### NON-TRAVLITE



The deluxe version features a velvet telescopic peg. Fits flutes and both French and German clarinets more securely. Peg detaches for compact packing with bag.

<b>DS640BB</b>	Flute Clarinet.....	<b>\$41.99</b>
	Velvet peg for flutes and French/German clarinets.	
<b>DS602B</b> .....	<b>\$22.99</b>	
	AGS design, portable with bag.	
<b>DS630BB</b>	Alto/Tenor Sax .....	<b>\$61.99</b>
	AGS design, tall stand for easier access.	
<b>DS730B</b>	Alto/Tenor Tall Sax .....	<b>\$85.99</b>

### TRAVLITE



<b>DS410B</b>	Trumpet, In Bell .....	<b>\$39.99</b>
<b>DS420B</b>	Trombone, In Bell .....	<b>83.99</b>
<b>DS431B</b>	Alto Sax, In Bell.....	<b>67.99</b>
<b>DS432B</b>	Tenor Sax, In Bell .....	<b>69.99</b>
<b>DS440B</b>	Clarinet, In Bell.....	<b>40.99</b>
<b>DS460B</b>	Flute .....	<b>36.99</b>
<b>DS461B</b>	Low B Flute .....	<b>42.99</b>

# HERCULES INSTRUMENT STANDS



### Trumpet/Cornet Stand

Features adjustable SFF-coated Trumpet and Cornet combo peg and swivel legs.

**DS510BB** with bag .....\$48.99



### Trumpet, Cornet and Flugelhorn Stand

Features two pegs for Trumpets or Cornets, one peg for Flugelhorn and swivel legs.

**DS513BB** with bag .....\$65.99



### Trombone Stand

Designed exclusively to support trombones more securely than any other stand available, the DS520B features the EZ Top Bracket

**DS520B** .....\$67.99



### Alto/Tenor Saxophone Stand

This solid lightweight stand features a folding yoke, adjustable bracket and swivel legs.

**DS530BB** with bag.....\$59.99



### Soprano Saxophone Stand

Features an adjustable Soprano Saxophone peg with SFF rubber and swivel legs.

**DS531BB** with bag .....\$62.99



### Alto/Tenor Saxophone and Flute/Clarinet Stand

Features a folding yoke, adjustable backrest and swivel legs.

**DS532BB** with bag .....\$62.99



### Alto/Tenor and Soprano Saxophone Stand

All the features found on the DS530B with an SFF-coated, height adjustable Soprano Saxophone peg.

**DS533BB** with bag .....\$62.99



### Baritone Saxophone Stand Bassoon Stand

Features a folding yoke, adjustable height backrest and swivel legs. Folds compactly for easy portability.

**DS535B**.....\$76.99  
**DS561B** Bassoon/Bass Clar .....\$11.99



### Baritone and Alto/Tenor Saxophone Stand

Same features as the DS535B with an additional Alto/Tenor Saxophone peg.

**DS536B** .....\$102.99



### Flute/Clarinet Stand Alto Flute Stand

Features a flute and clarinet combo peg with SFF rubber and swivel legs.

**DS640BB** with bag.....\$41.99  
**DS562BB** Alto Flute w/bag.....\$46.99



### Flute, Clarinet and Piccolo Combo Stand

Features two flute and clarinet combo pegs and one Piccolo peg.

**DS543BB** with bag .....\$58.99



### French Horn Stand

Features a yoke and backrest coated with SFF rubber that provides a safe resting place for your French Horn.

**DS550BB** with bag.....\$55.99



### Sousaphone Stand

Features: Folding upper yoke with SFF rubber. Locking pins located on the support housing for quick set-up

**DS551B** .....\$133.99



### Alto/Tenor/Soprano Sax Stand

Features: Swivel legs. Weight: 2.2 lbs. Folded size: 12.6" x 7.5".

**DS538B** .....\$124.99



### Alto/Tenor Sax Stand

Features: One stand for Alto and one stand for Tenor Sax and swivel legs. Weight: 1.8 lbs. Folded size: 12.6" x 7.5".

**DS537B** .....\$100.99



### Tuba/Euphonium/Baritone Horn/Alto Horn Stand

Features extended supports to accommodate various sized instruments, a locking pin and lever for quick set-up, and an all-in-one compact design.

**DS552B** .....\$126.99

# K&M INSTRUMENT STANDS



KM15232

Flute Stand: 4 Collapsible Legs

**KM15232** 18mm Peg\* .....\$20.99  
**KM15252** 9.5mm Peg .....24.99  
**KM15262** Sop/Piccolo .....24.99  
 \* = Stores In Flute



KM1494

**KM1494** Tuba .....\$164.99  
**KM14945B** Large Tuba.....299.99  
**KM14941B** Barihorn .....164.99  
**KM1495** Tuba, Playing .....149.99



KM1499BK

Trombone stand, two section.

**KM1499BK** .....\$89.99  
**KM1491B** Bass Trombone ....159.99  
**KM14985B** Tenor Tbone .....49.99



KM1501

Bass clarinet or bassoon stand. Nickel plated.

**KM1501** .....\$159.99



Soprano sax stand. Feet store in base.  
**KM15290** 5 Leg.....\$49.99



Clarinet stand. Folds for easy transport.

**KM15222** 4 Leg.....\$22.99  
**KM1522** 3 Leg.....19.99  
 Oboe stand, stores in bell  
**KM18020** 4 Leg .....\$37.99



KM1521

Trumpet stand. Stores in instrument bell.

**KM1521** .....\$24.99



Flugelhorn stand. Stores in instrument bell.

**KM15240** 5 Leg.....\$49.99



KM14300B

Alto or tenor sax stand.  
**KM14300B** Black, Saxxy .....\$47.99



Alto and tenor sax stand with peg.  
**KM14320** Double .....\$89.99



Trumpet stand. Stores in instrument bell.  
**KM15213B** 5 Legs .....\$31.99



KM1523

Flute stand. Feet store in peg bass.  
**KM1523** 18mm Peg .....\$19.99  
**KM1525** 9.5mm Peg .....24.99  
**KM1526** Piccolo .....24.99



KM14350B

**KM14350B** Tenor .....\$89.99  
**KM14340** Alto.....79.99



Bari sax stand.  
**KM14410B** .....\$109.99



Trombone stand. Stores in instrument bell.  
**KM1527** .....\$129.99



Midget Sax Stand stores in bell.  
**KM14360** Alto .....\$45.99  
**KM14365** Tenor .....49.99

# INSTRUMENT STANDS



Black stand holds either an alto or tenor sax. With peg.

**SAX30**.....\$27.30  
**SAX32** 2 Pegs.....33.00



Combination alto/tenor with two screw in pegs (5") for flutes. Black finish.

**SAX33** .....\$49.50



The baritone sax stand has a tripod base with tubular legs. There are two adjustment knobs. Black finish.

**SAX50**.....\$49.50  
**KB570** Baritone Sax, Chrome ..94.99



This trombone stand has soft, plastic umbrella shaped spring loaded below supports instrument and is adjustable on upper shaft. Black finish.

**TRO22**.....\$31.50  
**TS7101B** Trombone, On/Stage.29.99



**SW100S** Alto/Tenor Sax.....\$32.10  
**SW100SCL** Sax/Clarinet .....37.75  
**SAX34** Alto/Tenor, Standing.....49.50  
**SXS7101B** Alto/Tenor Sax w/Flute Peg, On/Stage.....31.99  
**SXS7401B** Tall Alto/Tenor Sax, On/Stage .....54.99



**KM18020** Oboe Stand Stores in Bell .....\$37.99  
**DSC7600** Desktop Clarinet/Flute, On/Stage.18.99



**HAMILTON**  
**KB960** Alto/Tenor, Black.....\$30.99  
**KB560** Alto/Tenor Sax, Chrome .....39.99



**HAMILTON**  
**KB952** Trombone, Black .....\$27.99  
**KB510** Trombone, Chrome .....30.99  
**KB511** Sock .....4.00



**TRU11** Trumpet.....\$22.50  
**TRS7301B** Trumpet, On/Stage .....21.99  
**KB950** Trumpet, Black, Hamilton .....19.99  
**KB500** Trumpet, Chrome, Hamilton.....23.95  
**KB501** Sock .....4.00



Collapsible stands.  
**SW100TP** Trumpet.....\$12.40  
**DST7600** Desktop Trumpet, On/Stage.....18.99

## MANHASSET STANDS



**MSTP** Stand In, Trumpet .....\$59.19



**MSFH** Stand In, Flugelhorn.....\$63.09

## PACK A STANDS



Stores inside bell.  
**6400** Clarinet .....\$15.30  
**7200** Trumpet.....25.65

# SELMER



## SELMER (PARIS) MOUTHPIECE CAPS

Nickel silver, silver plated.

<b>S238</b>	Bb Clarinet.....	<b>\$46.00</b>
<b>S338E</b>	Alto Clarinet.....	<b>52.00</b>
<b>S236</b>	BBb Contrabass Clarinet.....	<b>103.00</b>

Brass, gold lacquered.

<b>S437S</b>	Soprano Saxophone.....	<b>\$42.00</b>
<b>S437T</b>	Tenor Saxophone .....	<b>42.00</b>
<b>S437A</b>	Alto Saxophone .....	<b>44.00</b>

(For metal mouthpieces)

Brass, silver plated.

<b>SM404CAP</b>	Tenor (for M404 & MJ404) .....	<b>\$103.95</b>
-----------------	--------------------------------	-----------------

## CLARINET MOUTHPIECE CAPS

<b>S1740N</b>	Eb Soprano/Soprano Sax, nickel plated.....	<b>\$13.00</b>
<b>CG282C</b>	Bb, nickel plated.....	<b>9.45</b>
<b>S1720</b>	Bb, black plastic.....	<b>5.00</b>
<b>S1712N</b>	Alto Clarinet/Tenor Sax, nickel plated.....	<b>10.00</b>
<b>S282BC</b>	Bass, nickel plated.....	<b>24.00</b>
<b>S1699N</b>	EEb Contra-alto/Bari Sax, nickel plated.....	<b>27.00</b>

## SAXOPHONE MOUTHPIECE CAPS

<b>S1740N</b>	Soprano, nickel plated .....	<b>\$11.55</b>
<b>S282A</b>	Alto, nickel plated.....	<b>8.40</b>
<b>S1721</b>	Alto, black plastic.....	<b>4.00</b>
<b>S1712</b>	Tenor, gold lacquered.....	<b>10.00</b>
<b>S1712N</b>	Tenor, nickel plated.....	<b>9.00</b>
<b>S1699N</b>	Baritone, nickel plated .....	<b>24.50</b>
<b>S1716</b>	Baritone, gold lacquered, streamlined model .....	<b>12.50</b>

## BACH VALVE CASING BRUSH

<b>S817</b>	Bach valve casing brush .....	<b>\$5.00</b>
-------------	-------------------------------	---------------

## MOUTHPIECE BRUSHES

<b>S814</b>	Woodwind mouthpiece brush.....	<b>\$4.00</b>
<b>S815</b>	Brass instrument mouthpiece brush .....	<b>4.00</b>

## CLEANING BRUSH/DUSTER

<b>S816</b>	Cleaning brush/duster .....	<b>\$3.00</b>
-------------	-----------------------------	---------------

## ALUMINUM CLEANING RODS

<b>S370F</b>	Flute cleaning rod.....	<b>\$5.00</b>
<b>S370P</b>	Piccolo cleaning rod.....	<b>3.65</b>
<b>S370T</b>	Trumpet/Cornet cleaning rod.....	<b>5.00</b>
<b>S370B</b>	Trombone cleaning rod .....	<b>6.00</b>

## BACH GRIME GUTTERS

<b>S627TP</b>	Trumpet, Cornet, and Fluegelhorn .....	<b>\$8.00</b>
<b>S628</b>	Tuba, Baritone, and Euphonium .....	<b>10.00</b>



## TRUMPET/CORNET LYRES

<b>S1815</b>	Bach Trumpet/Cornet, clamp on, gold lacquered.....	<b>\$24.00</b>
<b>S1815S</b>	Same as above, silver plated .....	<b>28.00</b>
<b>S1815LS</b>	Lyre part for 1815S.....	<b>9.40</b>
<b>S1815C</b>	Clamp part only for 1815.....	<b>15.70</b>
<b>S1815CS</b>	Clamp part for 1815S .....	<b>15.70</b>
<b>S1691L</b>	Selmer Trumpet/Cornet, bent, large stem, gold lacquered. Fits Bach trumpets & standard Cornets.....	<b>10.00</b>
<b>S1691LS</b>	Same as above, nickel plated.....	<b>10.00</b>
<b>S1691</b>	Selmer Trumpet/Cornet, bent, small stem, gold lacquered.....	<b>10.00</b>
<b>S1691S</b>	Same as above, nickel plated.....	<b>10.00</b>
<b>S1700</b>	Selmer Trumpet/Cornet, straight stem, gold lacquered.....	<b>8.35</b>

## TROMBONE LYRES

<b>S1816</b>	Bach Tenor Trombone, adjustable, gold lacquered. Fits student model & Stradivarius models 6-36 .....	<b>\$17.00</b>
<b>S1816S</b>	Same as above, silver plated.....	<b>17.80</b>
<b>S1816L</b>	Bach Large Tenor/Bass Trombone, adjustable, gold lacquered. Fits Stradivarius models 42 & 50 .....	<b>16.00</b>
<b>S1817</b>	Bach Tenor Trombone, hinged lyre, designed for use on TB200 & TB200B models, is fully adjustable and gold lacquered .....	<b>25.15</b>

## CLARINET LYRES

<b>S1708</b>	Selmer Bb Clarinet, with ring, nickel plated .....	<b>\$11.00</b>
<b>S1692</b>	Selmer Alto Clarinet, nickel plated .....	<b>8.45</b>
<b>S1693</b>	Selmer Bass Clarinet, nickel plated .....	<b>10.00</b>

## SAXOPHONE LYRES

<b>S1702SX</b>	Selmer Alto and Tenor Saxophone, gold lacquered. Fits all Bundy & Selmer models except AS110.....	<b>\$10.00</b>
----------------	---	----------------

## FLUTE LYRE

<b>S1759</b>	Flute, wristband model, nickel plated .....	<b>\$25.00</b>
--------------	---	----------------



## BORE CLEANERS

Designed to keep bores clean and free from buildup.

<b>S392T</b>	Trumpet/Cornet/Horn bore cleaner.....	<b>\$8.00</b>
<b>S393T</b>	Trumpet/Cornet bore cleaner – plastic coated.....	<b>12.00</b>
<b>S392B</b>	Trombone bore cleaner .....	<b>10.00</b>
<b>S393B</b>	Trombone bore cleaner – plastic coated.....	<b>13.00</b>
<b>S631P</b>	French Horn bore cleaner – plastic coated.....	<b>10.00</b>
<b>S871</b>	Saxophone neck cleaner.....	<b>7.00</b>
<b>S871P</b>	Saxophone neck cleaner – plastic coated.....	<b>9.00</b>

## LIGATURES

Nickel silver, silver plated.

<b>S230E</b>	Eb Soprano Clarinet.....	<b>\$68.00</b>
<b>S234</b>	Alto Clarinet .....	<b>68.00</b>
<b>S235</b>	Bass Clarinet .....	<b>52.00</b>
<b>S240</b>	BBb Contrabass Clarinet.....	<b>68.00</b>

Brass, gold lacquered.

<b>S434S</b>	Soprano Saxophone.....	<b>\$42.00</b>
<b>S434A</b>	Alto Saxophone .....	<b>48.00</b>
<b>S434T</b>	Tenor Saxophone .....	<b>46.00</b>
<b>S434B</b>	Baritone Saxophone.....	<b>59.85</b>

(For metal mouthpieces)

Brass, silver plated.

<b>SM401LIG</b>	Soprano (for M401).....	<b>\$54.00</b>
<b>SM402LIG</b>	Alto (for M402 & MJ402) .....	<b>52.50</b>
<b>SM404LIG</b>	Tenor (for M404 & MJ404).....	<b>54.10</b>

## CLARINET LIGATURES

<b>S1739N</b>	Eb Soprano, nickel plated .....	<b>\$10.00</b>
<b>S1719</b>	Bb, nickel plated .....	<b>9.00</b>
<b>S1694</b>	Alto, nickel plated .....	<b>10.00</b>
<b>S1696</b>	Bass, nickel plated .....	<b>10.00</b>
<b>S1698N</b>	EEb Contra-alto/Bari Sax25 nickel plated .....	<b>20.00</b>

## SAXOPHONE LIGATURES

<b>S1739</b>	Soprano, gold lacquered.....	<b>\$10.00</b>
<b>S1739N</b>	Soprano, nickel plated.....	<b>10.00</b>
<b>S1714</b>	Alto, gold lacquered .....	<b>9.00</b>
<b>S1714N</b>	Alto, nickel plated .....	<b>9.00</b>
<b>S1715</b>	Tenor, gold lacquered.....	<b>10.00</b>
<b>S1715N</b>	Tenor, nickel plated .....	<b>9.00</b>
<b>S1698</b>	Baritone, gold lacquered.....	<b>14.00</b>
<b>S1698N</b>	Baritone, nickel plated.....	<b>20.00</b>

## SAXOPHONE END PLUGS

Molded high-impact plastic.

<b>S1723</b>	Alto Saxophone .....	<b>\$5.00</b>
<b>S1724</b>	Tenor Saxophone .....	<b>6.00</b>

## SAXOPHONE END PLUGS

Molded, high-impact plastic, Selmer Size

<b>S417A</b>	Alto Saxophone .....	<b>\$17.00</b>
<b>S417T</b>	Tenor Saxophone.....	<b>19.00</b>
<b>S417S</b>	Soprano Saxophone .....	<b>19.00</b>



## YAMAHA LIGATURES & CAPS



### LIGATURES

YAC1601	Bb Clarinet, nickel.....	\$13.99
YAC1604	Bb Bass Clarinet, silver.....	39.99
YAC1621	Bb Soprano Sax.....	29.99
YAC1607	Eb Alto Sax, gold.....	14.99
YAC1611	Bb Tenor Sax, gold.....	16.99
YAC1617	Eb Baritone Sax, gold.....	40.99

### CAPS

YAC1640	Bb Clarinet, plastic.....	\$6.99
YAC1645	Eb Alto Sax, plastic.....	7.99
YAC1650	Bb Tenor Sax, plastic.....	7.99
YAC1656	EB Baritone Sax.....	39.99

## LUYBEN LIGATURE



### CAP AND LIGATURE COMBO

LL	.....	\$14.00
----	-------	---------

Specify: Black, Clear, Red Purple, Blue, Green, Silver or Yellow.

## GIGLIOTTI LIGATURES AND CAPS

GLIGCL	.....	\$25.00B
GLIGAS	.....	30.00B
GIGSCREW	.....	\$1.35
GLIGTS	.....	32.00B

## H & B LIGATURES & CAPS



### LIGATURES

HB100C	Clarinet.....	\$16.35
HB100EC	Eb Clarinet.....	\$16.55
HB100AS	Alto Sax.....	17.95
HB100TS	Tenor Sax.....	18.40
HB100BC	Bass Clarinet.....	19.70
HB100BSS	Bari Sax (Slim).....	24.95
HB100BSR	Bari Sax (Reg.).....	24.95
HB100SS	Soprano Sax.....	17.70

### CAPS

70BC	Bass Clarinet.....	\$21.80
70BSS	Bari Sax (Slim) 1 1/4".....	43.25

### LEATHER LIGATURE

HBLCLL	Clarinet.....	\$48.60
HBLASL	Alto Sax.....	48.85

## ROVNER LIGATURES

### ROVNER



1R

### VERSA



V1R

### VERSA X



VX1R

### STAR



SS1R

### LEGACY



LG1R

### MKIII



C1R

### PLATINUM



P1R

### VAN GOGH



VG1R

Mouthpiece	"Dark"	"Light"	MKII	Star Series	Legacy	Verse-X	Versa	Platinum	Van Gogh
Small plastic soprano sax	1RXS	-	-	-	-	-	V1RXS	-	-
Standard soprano sax	1RVS	L3	C1RVS	SS1RVS	LG1RVS	VX1RVS	V1RVS	P1RVS	VG1RVS
Eb clarinet	1E	L4	-	-	-	-	-	-	-
Slim alto sax	1RR	-	-	-	-	-	-	-	-
Bb clarinet/Euro string	1E	-	-	SS1E	LG1E	VX1E	V1E	-	VG1E
Standard Bb clarinet	1R	L5	C1R	SS1R	LG1R	VX1R	V1R	P1R	VG1R
Standard alto sax	1RL	L6	C1RL	SS1RL	LG1RL	VX1RL	V1RL	P1RL	VG1RL
Alto clarinet	2RS	L7	-	-	-	-	-	-	-
Slim baritone sax	2RBL	L7.5	-	-	-	-	-	-	-
Standard tenor sax	2R	L8	C2R	SS2R	LG2R	VX2R	V2R	P2R	VG2R
Standard baritone sax	3R	L9	C3R	SS3R	LG3R	VX3R	V3R	P3R	VG3R
Bass clarinet, baritone sax	3RL	L10	C3RL	SS3RL	LG3RL	VX3RL	V3RL	P3RL	VG3RL
Eb contra-alto clarinet	4RS	-	-	-	-	-	-	-	-
Bass sax	4R	-	-	-	-	-	-	-	-
BBb contrabass clarinet	4RL	-	-	-	-	-	-	-	-
<b>Metal MPC</b>									
Soprano (small)	1MD	-	-	-	-	-	-	-	VG1MD
Soprano (standard)	1MS	L2	-	-	-	-	-	-	-
Alto sax, small	-	-	-	-	-	-	V1MA	-	-
Alto sax, small tenor sax	1M	L11	-	SS1M	LG1M	VX1M	V1MT	P1M	VG1M
Large alto	-	-	-	-	-	-	V3MLA	-	-
Medium tenor sax	2M	L12	C2M	SS2M	LG2M	VX2M	V2MT	P2M	VG2M
Large tenor sax, small bari	3ML	L13	C3ML	SS3ML	LG3ML	VX3ML	V3MLT	P3ML	VG3ML
Large baritone sax	3MVL	L14	-	-	-	-	-	-	-

MOST MODELS	.....	\$34.95
MARK III	.....	43.95
LEGACY LG	.....	49.95
3R, 3RL, 4R, 4RL, 4RS, L9, L10	.....	36.95
C3R, C3RL, C1R, C2R, C2M, C2ML	.....	43.95
PLATINUM P	.....	96.95
VAN GOGHA	.....	69.95
VAN GOGH METAL	.....	81.95
VERSA	.....	81.95
VERSA X	.....	64.95
STAR SERIES SS	.....	23.95
ROVN Nut (B) Brass, (N) Nickel	.....	5.35
ROVS Screw (B) Brass, (N) Nickel	.....	5.35

CAPS	Specify Instrument.....	5.75
RC8	Soprano Sax	RC4 Bari Sax
RC7	Alto Sax	RC5 Tenor Sax (M)
RC3	Tenor Sax	RC7 Clarinet
RC3	Alto Clarinet	

### I.E. RC7 = Clarinet Cap

The Turbo-Charger Kit is a revolutionary option for any Star Series of Legacy player seeking to amp up their sound.

TCKLN	Nickel, Long.....	\$44.95
TCKSN	Nickel, Short.....	29.95
TCKLGO	Gold, Long.....	49.95
TCKSGO	Gold, Short.....	37.95

L: TSax, BSax, BClar S: Clar, SSax, ASax

## ROBERT VINSON



Equal-tone ligatures enhance sound.

RVECLC	Clarinet Lig & Cap.....	\$17.95
RVEASC	Alto Sax Lig & Cap.....	19.95
RVETSC	Tenor Sax Lig & Cap.....	21.95

## JEWEL LIGATURES



JHTSCL	Clarinet.....	\$20.00
JHTSAL	Alto Sax.....	20.00
JHTSTL	Tenor Sax.....	20.00

# LIGATURES & CAPS



## AMPLATE LIGATURES

332N	Bb Clarinet.....	\$4.95
332RSN	Bb Clarinet Inverted...	9.00
333G	Soprano Sax.....	8.05
334G	Alto Sax.....	5.75
336G	Tenor Sax.....	6.30
337N	Bari Sax Full Sized.....	8.90
337G	Bari Sax.....	9.75
337SN	Bari Sax Slim.....	6.30
H337N	Bari Sax Mid Sized.....	9.75
531N	Bass Clarinet.....	9.35
530N	Alto Clarinet.....	9.35
HACLGO	Clarinet/Alto.....	31.20

## TROPHY LIGATURES

TR9331N	Soprano Sax.....	\$5.55
TR9331G	Soprano Sax.....	6.00
TR9332N	Bb Clarinet.....	4.25
TR9334G	Eb Alto Sax.....	4.75
TR9334N	Alto Sax.....	4.25
TR9336G	Bb Tenor Sax.....	5.25
TR9336N	Tenor Sax.....	4.75
TR9337G	Bari Sax.....	7.00



## CAPS/PLUGS

<b>METAL</b>		
324N	Bb Clarinet.....	\$6.80
325G	Soprano Sax.....	9.35
326G	Alto Sax.....	8.15
328G	Tenor Sax.....	9.00
330G	Bari Sax.....	15.25
TR9324N	Bb Clarinet.....	5.75
TR9326N	Eb Alto Sax.....	6.00
TR9328N	Bb Tenor Sax.....	6.25
ACC	Alto Clarinet.....	30.00
EFCC	Eb Clarinet.....	26.80

## PLASTIC

ASC1	Alto Sax Cap.....	\$1.70
TNC1	Tenor Sax Cap.....	1.80
CLC1	Clarinet Cap.....	1.55
521P	Bass Clar Cap.....	5.05
3271	Clarinet Cap.....	1.05
3272	Alto Sax Cap.....	1.20
3273	Tenor Sax Cap.....	1.30
SSC1	Soprano Sax Cap.....	2.60
AEP1	Alto Sax Plug.....	2.55
TEP1	Tenor Sax Plug.....	2.70
YAC1073P	Alto Sax Plug.....	3.99
YAC1074P	Tenor Sax Plug.....	4.99

## LIGATURE SCREWS

596N	Nickel.....	\$2.00
596G	Gold.....	2.00
585G	Gold, Sax Neck.....	2.95
585B	Brass, Sax Neck.....	2.95



## RICO

<b>CAPS (PLASTIC)</b>		
RCL1C	Bb Clarinet.....	\$12.75
REC1C	Eb Clarinet.....	15.50
RSS1C	Soprano Sax.....	20.75
RAS1C	Alto Sax.....	14.75
RTS1C	Tenor Sax (Rubber).....	20.75
RTS2C	Tenor Sax (Metal).....	20.75
RBS1C	Baritone Sax.....	23.25

## LIGATURES (NICKEL)

REC1LN	Eb Clarinet.....	\$21.00
RCL1LN	Bb Clarinet.....	15.00
RSS1LN	Soprano Sax.....	21.00
RAS1LN	Alto Sax.....	19.00
RTS2LN	Tenor Sax (Metal).....	21.00

## LIG & CAP SETS

REC1N	Eb Clarinet.....	\$37.00
RCL1N	Bb Clarinet.....	25.00
RSS1N	Soprano Sax.....	36.50
RAS1N	Alto Sax.....	30.75
RTS1N	Tenor Sax (Rubber).....	35.00
RTS2N	Tenor Sax (Metal).....	36.50
RBS1N	Baritone Sax.....	41.75



## RICO

### H-LIGATURES AND CAPS SETS

Four-point "H"-system applies equal pressure to the reed.

HEC1S	Eb Clarinet Silver.....	\$50.00
HCL1S	Bb Clarinet Silver.....	38.00
HCL1G	Bb Clarinet Gold.....	51.50
HBC1S	Bass Clarinet Silver (Selmer™ Style Mouthpiece).....	72.75
HSS1G	Soprano Sax Gold.....	55.75
HAS1S	Alto Sax Silver.....	44.00
HAS1G	Alto Sax Gold.....	55.75
HTS1G	Tenor Sax Hard Rubber Gold.....	60.25
HTS2G	Tenor Sax Otto Link (Metal Link) Gold.....	60.25
HBS1G	Baritone Sax Gold (Graftonite).....	72.50
HBS2G	Baritone Sax Gold (Selmer™ Style Mouthpiece).....	72.50

# SELMER LIGATURES



## SAXOPHONE LIGATURES

S1739	Soprano, gold.....	\$10.00
S1739N	Soprano, nickel.....	10.00
S1714	Alto, gold.....	9.00
S1714N	Alto, nickel.....	9.00
S1715	Tenor, gold.....	10.00
S1715N	Tenor, nickel.....	9.00
S1698	Baritone, gold.....	14.00
S1698N	Baritone, nickel.....	20.00



## CLARINET LIGATURES

S1739N	Eb Soprano, nickel...	\$10.00
S1719	Bb, nickel.....	9.00
S1694	Alto, nickel.....	10.00
S1696	Bass, nickel.....	10.00
S1698N	EEb Contra, nickel.....	20.00



## SAXOPHONE MOUTHPIECE CAPS

S1740N	Soprano, nickel plated.....	\$13.00
S282A	Alto, nickel plated.....	10.00
S1721	Alto, black plastic.....	4.00
S1712	Tenor, gold lacquered.....	10.00
S1712N	Tenor, nickel plated.....	10.00
S1699N	Baritone, nickel plated.....	27.00
S1716	Baritone, gold lacquered, streamlined model.....	14.00



## STERISOL GERMICIDE

1885	Pump.....	\$5.80
1874	2 oz. (makes one quart).....	4.50
1875	8 oz. (makes one gallon).....	8.95

# BONADE



## BONADE CAPS

B2250C	Bb Clarinet.....	\$31.00
B2250UC	BB Clarinet, Inverted.....	31.00
B2251UC	Eb Clarinet, Inverted.....	36.00
B2254C	Alto Sax.....	33.00
B2254GC	Alto Sax, Gold.....	33.00
B2254UGC	Alto Sax, Inverted, Gold.....	33.00
B2255C	Tenor Sax.....	33.00
B2255GC	Tenor Sax, Gold.....	35.00
B2255UGC	Tenor Sax, Inverted, Gold.....	35.00
B2257GC	Soprano Sax, Gold.....	29.00
B2257UGC	Soprano Sax, Inverted, Gold.....	29.00

## BONADE LIGATURES

B2250	Bb Clarinet.....	\$35.00
B2250U	Bb Clarinet, Inverted.....	35.00
B2251	Eb Clarinet.....	33.00
B2251U	Eb Clarinet, Inverted.....	33.00
B2253	Bass Clarinet.....	45.00
B2253U	Bass Clarinet, Inverted.....	45.00
B2254	Alto Sax.....	38.00
B2254G	Alto Sax, Gold.....	37.00
B2254U	Alto Sax, Inverted.....	38.00
B2254UG	Alto Sax, Inverted, Gold.....	37.00
B2255	Tenor Sax.....	39.00
B2255G	Tenor Sax, Gold.....	43.00
B2255U	Tenor Sax, Inverted.....	39.00
B2255UG	Tenor Sax, Inverted, Gold.....	43.00
B2257	Soprano Sax.....	36.00
B2257G	Soprano Sax, Gold.....	37.00
B2257U	Soprano Sax, Inverted.....	36.00
B2257UG	Soprano Sax, Inverted, Gold.....	37.00



## MI-T-MIST

Roche-Thomas pump mist cleaner.

RT15	2 Oz.....	\$ 4.95
RT55	8 Oz.....	10.75
RT125	32 Oz.....	20.75

# Ligatures



The new M/O ligature combines the lightweight construction of the legendary Masters ligature with the highly efficient tightening of the OPTIMUM ligature.

- Lightweight
- Easy to set up
- Quick and symmetrical tightening with a unique double-track screw mechanism
- Two small contact points only on the reed with an inverted tightening

Thus, the M/O ligature allows an optimum vibration of the reed and a crisp articulation.



Clarinet	Ligature and Plastic Cap			
	Black	Pewter Finish	Silver Plated	Gold Plated
Bb	LC51BP.....\$71.99	LC51PP.....\$71.99	LC51SP.....\$88.99	LC51GP.....\$139.99
Bb MASTERS	LC61BP.....\$71.99	LC61PP.....\$71.99	LC61SP.....\$88.99	LC61GP.....\$139.99
Eb	LC52BP.....\$71.99	LC52PP.....\$71.99	LC52SP.....\$88.99	
Alto	LC53BP.....\$71.99	LC53PP.....\$71.99	LC53SP.....\$88.99	
Bass	LC54BP.....\$86.99	LC54PP.....\$86.99	LC54SP.....\$108.99	

These series M/O ligatures are designed to fit the specific shape of the MASTERS mouthpieces. Both ligatures and caps are differentiated by the logo.



Saxophone	NEW	Ligature and Plastic Cap		
		Gold Finish	Aged Gold Finish	Gold Plated
Soprano		LC56DP.....\$87.99	LC56AP.....\$87.99	LC56GP.....\$139.99
Alto		LC57DP.....\$80.99	LC57AP.....\$80.99	LC57GP.....\$139.99
(except V16 metal) Tenor		LC58DP.....\$87.99	LC58AP.....\$87.99	LC58GP.....\$152.99
Baritone		LC59DP.....\$97.99	LC59AP.....\$97.99	
V16 ebonite Baritone		LC590DP.....\$97.99	LC590AP.....\$97.99	



## M/O LITE Ligatures



Made of synthetic material, the M/O LITE ligature is flexible, very light, impact-resistant and non-deformable. It has the same characteristics as the M/O ligature: easy to set up, quick and symmetrical tightening with a unique double-track screw mechanism, and inverted tightening with only two small contact points on the reed.

Clarinet	NEW	Ligature and Plastic Cap
Bb		LC71BP.....\$49.99

## MORE VANDOREN LIGATURES & CAPS



### Leather Ligatures

Clarinet	
LC21P w/ Plastic Cap.....	\$105.99
LC21L w/ Leather Cap.....	134.00
C21L Leather Cap.....	57.00

Alto Sax	
LC27P w/ Plastic Cap.....	\$105.99
LC27L w/ Leather Cap.....	134.00
C27L Leather Cap.....	60.99

### Optimum Ligatures & Caps

Clarinet (Silver Plated)	
LC01P Bb.....	\$139.99
LC04P Bass.....	136.00

Saxophone (Gold Plated)	
LC07P Alto.....	\$139.99
LC08P Tenor.....	139.99
LC09P Baritone.....	139.99



## BOIS LIGATURES



### Classical Ligature

#### Made of Delrin

<b>BLBFCL</b>	Bb Clarinet.....	<b>\$24.75</b>
<b>BLEFCL</b>	Eb Clarinet.....	<b>24.75</b>
<b>BLBCCL</b>	Bass Clarinet.....	<b>28.75</b>
<b>BLSSCL</b>	Soprano Sax.....	<b>28.75</b>
<b>BLASCL</b>	Alto Sax.....	<b>28.75</b>
<b>BLTSCCL</b>	Tenor Sax.....	<b>28.75</b>
<b>BLBCL</b>	Bari Sax.....	<b>28.75</b>
<b>BLASM</b>	Alto/Metal Sax.....	<b>28.75</b>
<b>BLTSM</b>	Tenor/Metal Sax.....	<b>28.75</b>

Allows for optimal reed vibration. Made of indestructible Delrin® material or metal silver. Won't dampen natural mouthpiece vibrations. No screws. Interior ring grabs hold to prevent slipping. Soft contact points with the reed. Very free-blowing feel. Does not slip or stretch. Each Bois Ligature comes in a case with a mouthpiece cap.

### Excellente Ligature

#### Made of Metal Silver

<b>BLBFEX</b>	Bb Clarinet.....	<b>\$43.95</b>
<b>BLEFEX</b>	Eb Clarinet.....	<b>43.95</b>
<b>BLNCEX</b>	Bass Clarinet.....	<b>47.95</b>
<b>BLSSEX</b>	Soprano Sax.....	<b>47.95</b>
<b>BLAEX</b>	Alto Sax.....	<b>47.95</b>
<b>BLTSEX</b>	Tenor Sax.....	<b>47.95</b>
<b>BLBSEX</b>	Bari Sax.....	<b>47.95</b>
<b>BLASMEX</b>	Alto/Metal Sax.....	<b>47.95</b>
<b>BLTSMEX</b>	Tenor/Metal Sax.....	<b>47.95</b>

## AMPLATE LYRES



<b>511G</b>	Trombone Lyre (1 pc.) 9/16.....	<b>\$8.25</b>
<b>511AN</b>	Trombone, Nickel, Fits all.....	<b>11.00</b>
<b>511AG</b>	Trombone, Brass, Fits all.....	<b>11.60</b>
<b>514AN</b>	Trombone, Nickel, Fits all, Sliding Head.....	<b>13.65</b>
<b>514AG</b>	Trombone, Brass, Fits all, Sliding Head.....	<b>14.10</b>
<b>514BG</b>	Bass T/Bone (2 pc), Gold.....	<b>12.00</b>
<b>514G</b>	Trombone Lyres (2 pc.) 9/16.....	<b>9.45</b>
<b>515G</b>	Trumpet Lyre, Brass (2 pc), fits all sliding head.....	<b>18.45</b>
<b>515N</b>	Trumpet Lyre, Nickel (2 pc), fits all sliding head.....	<b>18.45</b>
<b>517G</b>	Sax Gold Lacquer.....	<b>4.85</b>
<b>517N</b>	Sax Nickel.....	<b>4.40</b>
<b>506N</b>	Middle Joint Clar. Nickel.....	<b>7.00</b>
<b>506NR</b>	Ring Only.....	<b>4.50</b>
<b>513N</b>	Clamp on Flute Lyre.....	<b>12.65</b>
<b>510N</b>	Wrist Flute Lyre.....	<b>14.25</b>
<b>500LG</b>	Sousaphone Lyre, 6" Stem.....	<b>4.75</b>
<b>500LN</b>	Sousaphone Lyre, Nickel.....	<b>4.25</b>
<b>502N</b>	Clamp on Trumpet Lyre.....	<b>10.30</b>
<b>501G</b>	Bent Shank Trumpet.....	<b>4.60</b>
<b>501N</b>	Bent Shank Trumpet, Nickel.....	<b>4.05</b>
<b>500G</b>	Trumpet Sq Shank Gold.....	<b>4.35</b>
<b>500 XLG</b>	Extra Long Shank, 8" Stem.....	<b>5.05</b>
<b>502513</b>	Screw for Clamp on Lyres.....	<b>2.70</b>
<b>507N</b>	Bass Clarinet Lyre, Nickel.....	<b>5.50</b>

## TROPHY LYRES

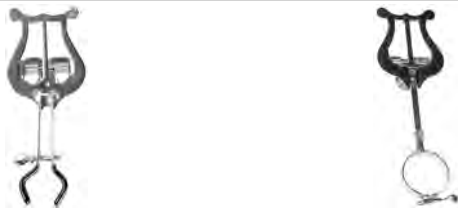

<b>TR9506N</b>	Clarinet Lyre with ring, nickel-plated.....	<b>\$7.50</b>
<b>TR9501G</b>	Trumpet Lyre, bent stem, gold-lacquered.....	<b>4.00</b>
<b>TR9502N</b>	Universal Trumpet Lyre clamp-on nick-plated.....	<b>8.95</b>
<b>TR9500G</b>	Straight Trumpet Lyre, gold-lacquered.....	<b>3.75</b>
<b>TR9510N</b>	Wrist Lyre, Piccolo/Flute, nickel-plated.....	<b>13.00</b>
<b>TR9511G</b>	One-piece Trombone Lyre, 9/16" gold-lac.....	<b>7.00</b>
<b>TR9514G</b>	Two-piece Trombone Lyre, 9/16" gold-lac.....	<b>7.95</b>
<b>TR9517G</b>	Saxophone Lyre, gold-lacquered.....	<b>4.30</b>
<b>TR9500LG</b>	Straight Sousaphone Lyre, gold-lacquered.....	<b>4.05</b>
<b>TR9513N</b>	Flute Lyre, clamp-on, nickel-plated.....	<b>11.95</b>

## CONN PLASTI LYRES



<b>CG575</b>	Clarinet.....	<b>\$12.00</b>
<b>CG576</b>	Alto/Bass Clarinet.....	<b>11.00</b>
<b>CG572</b>	Alto/Tenor Saxophone.....	<b>11.00</b>
<b>CG573</b>	Baritone Saxophone.....	<b>12.00</b>
<b>CG5704</b>	4" stem, 1" bend.....	<b>10.00</b>
<b>CG5706</b>	6" stem, 2" bend.....	<b>10.00</b>
<b>CG577</b>	Tenor Trombone.....	<b>16.00</b>
<b>CG577L</b>	Tenor Trombone, large bore.....	<b>16.00</b>
<b>CG578</b>	Tenor Trombone, 2 piece.....	<b>15.00</b>
<b>CG579</b>	Bass Trombone.....	<b>12.55</b>
<b>CG5714</b>	4" Trumpet.....	<b>10.00</b>
<b>CG5716</b>	6".....	<b>10.00</b>
<b>CG5748</b>	8" Bendable.....	<b>10.00</b>
<b>CG5806</b>	6" Bendable.....	<b>11.00</b>
<b>CG5809</b>	9" Bendable.....	<b>11.00</b>

## DEG LYRES

<b>DEGHC225</b>	Flutist Friend.....	<b>\$15.00</b>
<b>DEGHC240</b>	Drum Delight.....	<b>13.50</b>
<b>DEGHC245</b>	Bass Drum.....	<b>16.50</b>
<b>DEGHC250</b>	Trombone Clamps on Bell.....	<b>15.00</b>
<b>DEGHC260</b>	Trumpet, Clamps on Bell.....	<b>15.00</b>
<b>WCK</b>	Wind Clip Kit.....	<b>5.00B</b>



## YAMAHA LYRES

<b>YAC1520N</b>	Bb clarinet w/ring; nickel.....	<b>\$11.99</b>
<b>YAC1515G</b>	Saxophone; gold.....	<b>11.99</b>
<b>YAC1500G</b>	Trumpet/cornet; gold.....	<b>9.99</b>
<b>YAC1500N</b>	Trumpet/cornet; nickel.....	<b>9.99</b>
<b>YAC1505G</b>	Trombone; gold.....	<b>14.99</b>
<b>YAC1505N</b>	Trombone; nickel.....	<b>14.99</b>
<b>YAC1508G</b>	Marching mellophone; gold.....	<b>19.99</b>
<b>YAC1508N</b>	Marching mellophone; nickel.....	<b>19.99</b>
<b>YAC1509G</b>	Marching baritone; gold.....	<b>17.99</b>
<b>YAC1509N</b>	Marching baritone; nickel.....	<b>17.99</b>
<b>YAC1510G</b>	Baritone/French horn; gold.....	<b>10.99</b>
<b>YAC1510N</b>	Baritone/French horn; nickel.....	<b>10.99</b>
<b>YAC1512</b>	Marching tuba; gold.....	<b>19.99</b>
<b>YAC1522</b>	Marching drum lyre.....	<b>22.95</b>



## BO-PEP



- BOPEP1** Finger Rest.....\$13.15  
**BOPEP3** Finger Saddle (for smaller hands).....13.15  
**BOPEP5** Thumb Guide.....13.15

## RUNYON FLUTE CUSHIONS

**R15**.....\$5.45/2 pk.  
 One non-slip cushion, cushions the left hand index finger, "saddle." The other cushion is for the right hand thumb.

## FLUTE PLUGS



- R13** French Flute Plugs (5) Rubber.....\$7.45  
**YAC1071P10** French Flute Plugs.....7.99/10 pk.

## THUM EEZ



- Cushions the thumb rest.  
**TR2203** Clarinet.....\$1.50  
**TR2204** Saxophone.....1.50  
**YAC1075** Yamaha Bk, Br, Pi, B, G, O.....11.99

## THUMB CUSHIONS



- HE73** Herco Clarinet (2).....\$2.30  
**OSTHMI** Original (4).....3.00  
**A13MW100** Clarinet/Thumbulz.....2.00B

## THUMB SAVERS



- R3** Clarinet, Runyon.....\$3.30  
**R5** Saxophone, Runyon.....9.05  
**S1726** Clarinet, Selmer.....3.35  
**S1727** Saxophone, Selmer.....7.80

## ROBERT VINSON



- RVCTRR** Clarinet, Regular.....\$4.50  
**RVCTRT** Clarinet, Thin.....4.50

## RISERS



- R7** Pack of 3, Palm Key, Runyon.....\$8.60  
**R6** Pack of 4, Side Key, Runyon.....8.60

## POLISHING CLOTHS



- HE96** All Purpose, Herco.....\$4.87  
**HE97** Herco Miracle Cloth.....6.06  
**MIC7301** Dry shine polishing puff (Micro).....5.90  
**MIC7302** Dry shine polishing cloth(Micro).....8.40  
**HE90** Lacquer, Herco.....4.08  
**HE92** Silver, Herco.....4.08  
**BAPC** Plain Cloth, Players.....4.40  
**BASLV** Silver, Players.....6.20  
**BALQ** Lacquer, Players.....4.40  
**YAC1111P** Large Polish Cloth.....25.99  
**YAC1099P** Untreated, Yamaha.....8.99  
**YAC1100** Chamois Like, Yamaha.....39.99  
**BASP2** 2NI Silver, Plain.....6.85  
**BAPMITP** Polishing Mitt.....8.30  
**3589** Laquer.....3.45  
**3591** Wood.....3.45  
**3590** Silver.....3.45

## BLITZ CLOTHS



- BL302**.....\$4.50  
 Gloss care—maintenance of the finish on lacquered metal, plastic, and painted surfaces.  
**BL303**.....5.95  
 Metal care—contains two cloths. (1) cleaning and polishing, (2) buffing cloths.  
**BL304**.....3.75  
 Slide & Valve Care—cloth treated with cleaning and polishing agents to remove dirt, tarnish and old oil.  
**BL306**.....3.90  
 Gloss Care with Silicone for band instruments.  
**BL310**.....3.90  
 Nickel/Chrome  
**BL502**.....14.97/pr.  
 Silver Care Mitt  
**BL7808**  
 Micro Fiber.....4.95

## LOVE GLOVES



- Polishing gloves with "I love my ..." imprint.  
**AWB** Trombone.....\$11.95  
**AWF** Flute.....11.95  
**AWS** Saxophone.....11.95  
**AWT** Trumpet.....11.95  
**BAPMITP** Plain Mitt.....8.30

## POLISH



- 3431** Shine N Seal (LeBlanc) ....\$4.40  
**BP03511** Flitz, 6.3 oz.....13.20B  
**MIC7323** Nushine.....6.80  
**S2977** Lacquer Polish, Selmer.....5.00  
**YAC1060P** Yamaha Lacquer Polish....14.99  
**YAC1061P** Yamaha Silver Polish.....14.99  
**BL609** Blitz Brass, 8 oz.....4.95  
**BL620** Blitz Metal, 8 oz.....4.95

## SCREWDRIVERS



- MOODY**  
**580101** Screwdriver & awl set (Moody)....\$14.30  
**MIC6051** Sax Screwdriver – Micro.....8.25  
**MIC6053** Clarinet Screwdriver – Micro.....8.25

## PAD/CORK CEMENT



- MIC6060**.....\$10.15

## SHEET CORK

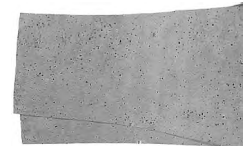

- "A-A quality". 12 x 4 inch sheet.  
**MIC6164** 1/64" thick.....\$26.30  
**MIC6132** 1/32" thick.....27.65  
**MIC6116** 1/16" thick.....33.60  
**MIC6332** 3/32" thick.....41.05  
**MIC6108** 1/8" thick.....48.45  
**MIC6010A** Alto Neck Corks.....7.15  
**MIC6010T** Tenor Neck Corks.....7.30  
**2738** Flute Head Corks.....2.55  
**FHC** Flute Head Corks.....6.00

## MICRO VALVE SPRINGS



- CORNET/TRUMPET**  
**MIC7000** Barrel Shape.....\$5.85/set  
**MIC7001** Small.....5.40/set  
**MIC7002** Medium.....5.85/set  
**MIC7002-1/2** Large.....5.85/set  
**SAXOPHONE SPRINGS**  
**MIC6025** Round, Assorted sizes.....\$81.00/100  
**CLARINET SPRINGS**  
**MIC5008** Round, Assorted sizes.....\$81.00/100  
**MIC5004** Complete set.....49.80/set

## YAMAHA ACCESSORIES



<b>YAC1660P</b>	Piccolo cleaning rod.....	<b>\$7.99</b>
<b>YAC1661P</b>	Flute cleaning rod, plastic.....	<b>7.99</b>
<b>YAC1662P</b>	Flute cleaning rod, wood.....	<b>17.99</b>
<b>YAC1663P</b>	Recorder cleaning rod.....	<b>5.99</b>
<b>YAC1665P</b>	Trombone cleaning rod.....	<b>10.99</b>



<b>YAC1050P</b>	Clarinet swab .....	<b>\$4.99</b>
<b>YAC1052P</b>	Clarinet cotton swab.....	<b>6.99</b>
<b>YAC1056P</b>	Saxophone swab/brush .....	<b>7.99</b>
<b>YAC1058P</b>	Saxophone neck cleaner .....	<b>6.99</b>
<b>YAC1062P</b>	Brass soap.....	<b>14.99</b>
<b>YAC1063P</b>	Flute cotton swab .....	<b>6.99</b>



<b>YAC1112P</b>	Powdered pad paper .....	<b>\$15.99</b>
<b>YAC1095P</b>	Cleaning papers .....	<b>10.99</b>
<b>YAC1059P</b>	Polishing Gauze .....	<b>8.99</b>
<b>YAC080000</b>	FrHorn valve string.....	<b>5.99</b>
<b>YAC1072P</b>	Flute key ring patches .....	<b>11.99</b>
<b>YAC1075BK</b>	Black thumb rest cushion .....	<b>11.99</b>
<b>YAC1075BR</b>	Brown thumb rest cushion.....	<b>11.99</b>

Also: (B) Blue, (G) Green, (O) Orange, (PI) Pink

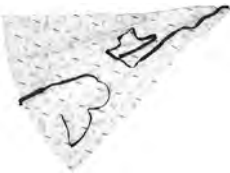

<b>YAC2050P</b>	Small cleaning swab, polyester.....	<b>\$16.99</b>
<b>YAC2051P</b>	Med. cleaning swab, polyester.....	<b>17.99</b>
<b>YAC2052P</b>	Large cleaning swab, polyester.....	<b>21.99</b>
<b>YAC2053P</b>	Saxophone swab, polyester .....	<b>32.99</b>
<b>YAC2054P</b>	Oboe swab, polyester .....	<b>32.99</b>
<b>YAC2055P</b>	Bassoon swab, one piece, polyester.....	<b>40.00</b>
<b>YAC2056P</b>	Bassoon swab, two piece, polyester .....	<b>55.99</b>



<b>YAC1077P</b>	Vinyl coat trumpet cleaner .....	<b>\$10.00</b>
<b>YAC1078P</b>	Vinyl coat trombone cleaner.....	<b>10.00</b>
<b>YAC1083P</b>	Nylon valve casing brush.....	<b>4.00</b>
<b>YAC1084P</b>	Brass mouthpiece brush.....	<b>3.00</b>
<b>YAC1085P</b>	Reed mouthpiece brush.....	<b>4.00</b>
<b>YAC1090P</b>	Mouthpiece Patch, Small.....	<b>10.99/4</b>
<b>YAC1093P</b>	Mouthpiece patch, med. thin.....	<b>10.99/4</b>

## GEM SILK SWABS



100% silk pull through swabs. Available in: (R) Red, (B) Blue, (PU) Purple, (SI) Silver, (G) Green, (BK) Black.

<b>GOS</b>	Oboe .....	<b>\$10.00</b>
<b>GBBS</b>	Bassoon Bocal.....	<b>7.00</b>
<b>GEHS</b>	English Horn .....	<b>11.00</b>
<b>GFS</b>	Flute.....	<b>12.00</b>
<b>GCLS</b>	Clarinet.....	<b>13.00</b>
<b>GBCLS</b>	Bass Clarinet.....	<b>22.00</b>
<b>GBS</b>	Bassoon.....	<b>16.00</b>
<b>GATSS</b>	Alto/Tenor Sax.....	<b>14.00</b>
<b>GDASS</b>	Deluxe Alto Sax.....	<b>19.00</b>
<b>GDSS</b>	Deluxe Tenor Sax.....	<b>22.00</b>
<b>GBSS</b>	Deluxe Bari Sax.....	<b>22.00</b>

## ORIGINAL SWABS



<b>OSFS1</b>	Flute.....	<b>\$6.50</b>
<b>OSFS2</b>	Flute*.....	<b>8.50</b>
<b>OSAFS1</b>	Alto Flute.....	<b>16.50</b>
<b>OSSC1</b>	Soprano Clarinet.....	<b>12.00</b>
<b>OSSC2</b>	Soprano Clarinet*.....	<b>12.50</b>
<b>OSAC1</b>	Alto Clar*.....	<b>12.50</b>
<b>OSBC1</b>	Bass Clar*.....	<b>14.00</b>
<b>OSAS1</b>	Alto Sax*.....	<b>20.00</b>
<b>OSTS1</b>	Tenor Sax*.....	<b>22.00</b>
<b>OSSS1</b>	Sop Sax*.....	<b>21.25</b>
<b>OSOBO1</b>	Oboe (2 Part)*.....	<b>24.00</b>
<b>OSENG1</b>	English Horn (2 Part)*.....	<b>24.50</b>
<b>OSBSN1</b>	Bassoon (2 Part)*.....	<b>25.00</b>
<b>OSBOC1</b>	Bocal*.....	<b>6.75</b>
<b>OSTPT1</b>	Trumpet Lead Pipe*.....	<b>8.75</b>
<b>OSFRN1</b>	French Horn*.....	<b>7.50</b>
<b>OSTB1</b>	Trombone Slide (2 Part).....	<b>11.50</b>
<b>OSPLSH1</b>	Polish Cloth Flann & Cotton.....	<b>10.50</b>

\* = w/cord & weight

## HODGE SILK SWABS



100% China silk available in Black (BK), Purple (PU), Blue (B), Burgundy (BU), Green (G).

<b>HPS</b>	Piccolo.....	<b>\$6.50</b>
<b>HFS</b>	Flute.....	<b>10.00</b>
<b>HCFS</b>	Flute, Curved.....	<b>11.00</b>
<b>HOS</b>	Oboe.....	<b>10.50</b>
<b>HLOS</b>	Oboe Long.....	<b>12.00</b>
<b>HEHS</b>	English Horn .....	<b>12.00</b>
<b>HCLS</b>	Clarinet .....	<b>15.50</b>
<b>HBCLS</b>	Bass Clarinet .....	<b>18.50</b>
<b>HASS</b>	Alto Sax.....	<b>17.50</b>
<b>HTSS</b>	Tenor Sax.....	<b>18.50</b>
<b>HSSS</b>	Soprano Sax.....	<b>15.50</b>
<b>HBS</b>	Bassoon.....	<b>12.50</b>
<b>HBBS</b>	Bassoon Bocal.....	<b>7.50</b>
<b>HOSC</b>	Oboe, Cotton, White.....	<b>6.50</b>
<b>HEHSC</b>	English Horn, Cotton, White .....	<b>12.00</b>
<b>HACS</b>	Alto Clarinet.....	<b>17.00</b>
<b>HBXSX</b>	Bari Sax.....	<b>30.00</b>
<b>HSRS</b>	Soprano Recorder.....	<b>6.50</b>
<b>HARS</b>	Alto Recorder.....	<b>10.00</b>
<b>HTRS</b>	Trumpet.....	<b>8.50</b>
<b>HFHS</b>	French Horn.....	<b>8.00</b>

## JEWEL SWABS



100% silk. Tye dye color

<b>JCLSTD</b>	Clarinet.....	<b>\$12.25</b>
<b>JBCLSTD</b>	Bass Clarinet .....	<b>14.70</b>
<b>JFSTD</b>	Flute .....	<b>9.80</b>
<b>JPSTD</b>	Piccolo.....	<b>9.30</b>
<b>JASSTD</b>	Alto Sax.....	<b>14.70</b>
<b>JTSSTD</b>	Tenor Sax.....	<b>15.00</b>
<b>JSSSTD</b>	Soprano Sax .....	<b>12.20</b>
<b>JSNSTD</b>	Sax Neck.....	<b>10.55</b>
<b>JOSTD</b>	Oboe.....	<b>10.55</b>
<b>JBSTD</b>	Bassoon.....	<b>15.00</b>
<b>JBBSTD</b>	Bassoon Bocal .....	<b>9.55</b>
<b>JTSTD</b>	Trumpet.....	<b>12.20</b>
<b>JTBSTD</b>	Trombone.....	<b>15.00</b>

## DEMAND SWABS



Black silk.

<b>OSPIC1</b>	Piccolo .....	<b>\$10.50</b>
<b>OSOBO2</b>	Oboe.....	<b>12.50</b>
<b>OSENG2</b>	English Horn.....	<b>13.50</b>
<b>OSBSN2</b>	Bassoon.....	<b>16.50</b>
<b>OSSAX1</b>	Sax.....	<b>25.00</b>
<b>OSSC2</b>	Clarinet .....	<b>12.00</b>
<b>OSBC2</b>	Bass Clarinet .....	<b>23.50</b>

## CLEAN SWEEP



Washable lint free system. Inserts in instrument.

<b>CSCL</b>	Clarinet .....	<b>\$11.55</b>
<b>CSFL</b>	Flute .....	<b>11.10</b>
<b>CSAS</b>	Alto Sax .....	<b>18.75</b>
<b>CSSS</b>	Soprano Sax .....	<b>18.10</b>
<b>CSTS</b>	Tenor Sax .....	<b>19.25</b>
<b>CSFLRC</b>	Flute Cloth.....	<b>3.20</b>

## SNAKES



<b>CFFS</b>	Flute.....	<b>\$12.95</b>
<b>CFS</b>	Clarinet .....	<b>12.95</b>
<b>PFS</b>	Piccolo.....	<b>12.95</b>

## SWABS



V1000	Clarinet, Wool	\$2.40
V1004	Flute	2.40
MIC5001	Clarinet Swab - Plain Wire	4.40
MIC5002	Same - Rubber Coated Wire	4.75
MIC5015	Flute Swab - Plain Wire	4.50
MIC5016	Piccolo or Recorder, Plain	4.00
RB01	Oboe Swab	7.85
RB02	Oboe Swab Set	15.80
MIC5017	Oboe Swab - 2 in 1	5.60
MIC5018	Oboe Swab Set	6.90
BABAS	Bassoon, Cotton	15.00
MIC5019	Bassoon Swab Set	26.10
YAC1054	Bassoon	26.99
TRRCS	Trumpet Lead Pipe, Chamois	5.05

## SAXOPHONE SWABS

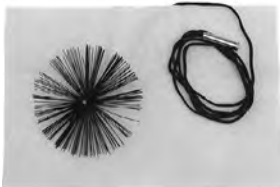

MIC6009	LePactole	\$6.85
HE56P	Herco	6.68
CSS	Chamois	5.40
TRS	Sham Chamois	4.05
RBHSS	Linen	7.50
SXRCAS	Alto Sax, Chamois	7.65
SXRCTS	Tenor Sax, Chamois	9.15
SHSWAB	Hanky	5.65

## CLARINET SWABS



MIC5005	LePactole	\$5.40
MIC5006	Cloth	3.60
RBHSC	Linen	5.20
HE53	Handkerchief Swab	9.52
MIC5009	Super Swab	4.35
TRC	Like Sham Chamois	29.90/dz.
HANKY	Handkerchief	4.75
SSBCS2	Bass Clarinet	2.75
CLRCS	Chamois	5.40
HE50P	Chamois	6.05
SW200	Vandoren, Micro Fiber	29.99
SW300	Vandoren, Bass Clarinet	48.99
CS1	Chamois	4.50

## SPITBALLS



HE185	Small	\$6.19
HE186	Large	5.88

## NECK CLEANERS

HE57P	Herco	\$6.18
HE58P	Vinyl coated, Herco	7.05
RBSNC	Players	3.60
MIC6015	Micro	7.10
MIC5020	Bassoon Bocal Vinyl	6.70
V1042	Venture, Vinyl	3.60
MSXNS	Players	4.75
SS2	Swab, Sham Chamois	3.40



## BRUSHES/CLEANERS



VALVE CASING		
HE83	Herco	\$3.38
MIC7313	Micro	3.50
V1023	Venture	1.80
RBTR3	Players	3.15
RBTR3W	Players, Wire Handle	2.95

BRASS MOUTHPIECE		
HE84	Herco	\$3.22
MIC7312	Micro	3.30
V1022	Venture	1.80
RBBR2	Players	3.15
RBBR2W	Players, Wire Handle	2.95
RBTSL	Large Two Step	3.75
RBTS	Small Two Step	3.60

REED MOUTHPIECE		
HE85	Herco	\$3.41
MIC7311	Micro	3.50
V1021	Venture	1.80
RBWW1	Players	3.15
RBWW1W	Players, Wire Handle	2.95

DUSTER BRUSH		
HE825	Herco	\$2.76
RBWW2	Players	2.45
YAC1048P	Yamaha	3.99

## CLEANING RODS/CLOTHS



359	Trumpet	\$4.89
360	Trombone	6.95
361	Flute (steel)	3.80
362	Piccolo	5.60
2720	Flute (aluminum)	4.50
8495	Recorder, Plastic	.55
HE54	Cleaning Rod Cloth	9.51
RBFL	Flute Cloth	4.10
SSFS1	Flute Rod Patch	1.80
FLRCS	Flute Chamois, 3 pack	6.20
TBRCS	Trombone, Chamois, 3 pack	6.50

Synthetic Rods		
CRFL	Flute	\$2.60
CRPIC	Piccolo	2.30
CRTB	Trombone	4.10

## LA VOZ PAD GARDS



LPGPI	Piccolo	\$11.00
LPGFL	Flute	14.00
LPGL	Clarinet	16.00
LPGAS	Alto Sax	24.25
LPGTS	Tenor Sax	25.75
LPGSS	Soprano Sax	20.50

NECK SAVER		
LABSNS	Alto/Bari Sax	\$10.25
LTSNS	Tenor Sax	10.25

MOUTHPIECE SAVER		
LCLASMP	Clar/Alto Sax	\$2.35
LTSMP	Tenor Sax	2.65

## BORE CLEANERS



MICTF30	Trumpet, Thermo Flex	\$8.05
MICTF42	Trombone, Thermo Flex	8.80
RBTR5P	Trumpet (Players) Synth	7.00
RBTR6P	Trombone (Players) Synth	7.65
MTBS	Trombone	6.85
MTRS	Trumpet	6.50
MIC7315	Cornet or Trumpet (Micro)	7.70
HE77P	Trumpet, Vinyl (Herco)	8.95
V1040	Trumpet, Vinyl (Venture)	4.80
MIC7316	Trombone (Micro)	8.35
MIC7317	Trombone, X Long (Micro)	10.05
HE78P	Trombone, Vinyl (Herco)	9.25
V1041	F. Horn Vinyl (Venture)	5.25
MIC7319	French Horn (Micro)	9.45
MIC7318	Baritone Horn (Micro)	10.05
V1043	F. Horn Vinyl (Venture)	5.25
PPTR2	Trumpet Brush Kit	13.20
Contains: bore cleaner, valve casing and mouthpiece brush.		
PPTB2	Trombone Brush Kit	10.75
Contains: bore cleaner and mouthpiece brush.		
RBMC6P	Low Brass	11.75
RBMC5P	5' French Horn	10.45

## PLAYERS SWABS



Thick, absorbent cloth swabs available in a variety of attractive colors.

RBCL	Clarinet	\$3.75
RBFL	Flute	4.10
RBTB	Trombone	4.75
RBSX	Saxophone	5.40
RBCL12	Clarinet 12/Jar	43.40
RBSX12	Saxophone 12/Jar	61.55

## HW PAD SAVERS



HWSS	Soprano Sax	\$21.00
HWCL	Clarinet	15.25
HWCLM	Clarinet, Multi-color	15.25
HWFL	Flute	13.65
HWFLM	Flute, Multi-color, 2 piece	15.50
HWPI	Piccolo	10.85
HWAS	Alto Sax	23.50
HWTS	Tenor Sax	25.00
HWBST	Trumpet Brass Saver	24.00
HWBSTB	T-Bone Brass Saver	15.00
HWBSBA	Bari Brass Saver	25.00
HWBSTU	Tuba Brass Saver	26.10
HWHBSB	Bari Bow	10.65
HWHBSF	French Horn Brass Saver	26.00

NECK SAVERS		
HWABN	Alto/Bari Sax	\$8.65
HWTGN	Tenor Sax	9.00

MOUTHPIECE SAVERS		
HWUMPA	Clarinet/Alto Sax	\$2.45

CLEANING SWABS		
HWABB	Alto Sax Bell Brush	\$23.50
HWTBB	Tenor Sax Bell Brush	25.00

## MICRO PADS



### CLARINET

<b>9M5311</b>	Bladder, Woven Felt, Bevelled .....	<b>\$19.50 dz.</b>
<b>10M5311</b>	Bladder, Woven Felt, Bevelled.....	<b>19.50 dz.</b>
<b>12.5M5311</b>	Bladder, Woven Felt, Bevelled.....	<b>19.50 dz.</b>
<b>15.5M5311</b>	Bladder, Woven Felt, Bevelled.....	<b>19.50 dz.</b>
<b>17M5311</b>	Bladder, Woven Felt, Bevelled.....	<b>19.50 dz.</b>
<b>FLUTE</b>		
<b>11.5M5307</b>	Bladder, Woven Felt .....	<b>\$20.55 dz.</b>
<b>18M5307</b>	Bladder, Woven Felt.....	<b>20.55 dz.</b>

## MICRO PAD SETS

<b>MIC5325</b>	Piccolo, Bladder, Thick .....	<b>\$27.55</b>
<b>MIC5340</b>	Oboe, Bladder .....	<b>25.95</b>
<b>MIC5318</b>	Clarinet, Bladder, Thick.....	<b>21.45</b>
<b>MIC5303</b>	Clarinet, Bladder.....	<b>21.45</b>
<b>MIC5328</b>	Clarinet, Tan Kid.....	<b>28.50</b>
<b>MIC5305</b>	Clarinet, White Kid.....	<b>25.65</b>
<b>MIC5335</b>	Alto Clarinet, Tan Kid.....	<b>45.00</b>
<b>MIC5304</b>	Flute, Boehm Sys.....	<b>22.65</b>
<b>MIC5342</b>	Bassoon, Tan Kid.....	<b>57.50</b>
<b>MIC550A</b>	Alto, Tan Stitch, Plain.....	<b>78.20</b>
<b>MIC550T</b>	Tenor, Tan Stitch, Plain.....	<b>88.35</b>
<b>MIC560A</b>	Alto, Plain, Full Back.....	<b>78.60</b>
<b>MIC570A</b>	Alto, Rivet, Tan Stitch.....	<b>84.35</b>
<b>MIC580A</b>	Alto, Rivet, Full Back.....	<b>84.35</b>
<b>MIC590A</b>	Alto, Plastic Resonator.....	<b>93.30</b>
<b>MIC590T</b>	Tenor, Plastic Resonator.....	<b>110.40</b>

## HERMES PAD SETS



<b>PMI3252</b>	Clarinet, Dbl, Bladder, Woven Felt.....	<b>\$ 46.80</b>
<b>PMI3255</b>	Clarinet, Dbl, Bladder, Pressed Felt .....	<b>46.80</b>
<b>PMI4252</b>	Flute, Dbl. Bladder, Transparent.....	<b>54.80</b>
<b>PMI4302</b>	Flute, Dbl. Bladder, Yellow.....	<b>54.80</b>
<b>PMI4256</b>	Flute, Open Hole.....	<b>54.80</b>
<b>PMI215A</b>	Alto Sax, Full Back, Plain.....	<b>128.00</b>
<b>PMI215T</b>	Tenor Sax, Full Back, Plain.....	<b>152.00</b>
<b>PMI290A</b>	Alto Sax, Full Back, Rivet.....	<b>131.00</b>
<b>PMI290T</b>	Tenor Sax, Full Back, Rivet.....	<b>155.20</b>
<b>PMI275A</b>	Alto Sax, Full Back, Plastic .....	<b>159.40</b>
<b>PMI275T</b>	Tenor Sax, Full Back, Plastic .....	<b>183.40</b>
<b>DOPE</b>	Pad Dope.....	<b>12.45</b>
<b>MIC6060</b>	Pad Cement.....	<b>10.15</b>

## MICRO UTILITY KITS



Contains pads, springs, neck cork, sheet cork, cement, cork grease, bumpers and sand paper.

<b>MIC5170</b>	Clarinet .....	<b>\$18.15</b>
<b>MIC6170</b>	Saxophone .....	<b>\$18.85</b>

## HERCO MAINTENANCE KITS



### TRUMPET- CORNET

Contains: Wilwerk Valve Oil, Brass Mouthpiece Brush, Valve Casing Brush, Valve Protector, Flexible Cleaner, "Spitballs" Cleaning Discs, Polishing Cloth and Tuning Slide Grease.

**HE81** Complete Kit.....**\$27.30**

### WOOD CLARINET

Contains: Cork Grease, 2 Thumb Rest Cushions, Swab, Reed Mouthpiece Brush Key Oil, Polishing Cloth, Bore Oil, Cotton Brush Swab.

**HE105** Complete Kit.....**\$24.12**

## SUPERSLICK MAINTENANCE KITS



### TRUMPET CARE KIT (LACQUER OR SILVER)

A great assortment of high quality products to care for your Trumpet, including: Polish Cloth (lacquer or silver) Superslick Valve Oil 1.25 oz., Superslick Tuning Slide Grease Vinyl Cleaning Snake Mouthpiece Brush Valve Casing Brush Care.

**SSBRCK**.....**\$17.10**

**Add L for Lacquer, or S for Silver**

### ALTO/TENOR SAXOPHONE CARE KIT

Lacquer Polish Cloth Superslick Cork Grease Tiger Rag Body Swab Reedguard 2 Double End Duster Brush Muthpiece Brush Tiger Rag Neck Swab Care Instructions.

**SSASCK**.....**\$18.00**

### TROMBONE CARE KIT

A great assortment of high quality products to care for your Trombone including: Lacquer Polish Cloth Superslick Slide Oil 1.25 oz. Superslick Tuning Slide Grease Vinyl Cleaning Snake Mouthpiece Brush Care Instructions.

**SSTK**.....**\$16.20**

### FRENCH HORN CARE KIT

A great assortment of high quality products to care for your French Horn including: Lacquer Polish Superslick Key and Rotor Oiler Vinyl Cleaning Snake Mouthpiece Brush Care Instructions.

**SSFHCK**.....**\$18.00**

### BASSOON CARE KIT

Wood Polish Cloth Superslick Cork Grease Thumb Cushion Double End Duster Brush Care Instructions.

**SSBSNCK**.....**\$20.70**

### SOPRANO SAX CARE KIT

Lacquer Polish Cloth Superslick Cork Grease Reedguard 2 Double End Duster Brush Mouthpiece Brush Care Instructions.

**SSSSCK**.....**\$20.70**

### TUBA CARE KIT

A great assortment of high quality components to care for your Tuba including: Polish Cloth (lacquer or silver), Superslick Valve Oil 1.25 oz. Superslick Tuning Slide Grease Mouthpiece Brush Large Valve Casing Brush Care Instructions.

**SSTHCK**.....**\$18.90**

### STRING CARE KIT

Wood Polish Cloth White Hanky, No String American Way Instrument Polish Dark Rosin Care Instructions.

**SSVCK**.....**\$14.40**

### COMPOSITION CLARINET

Contains: Cork Grease, 2 Thumb Rest Cushions, Swab, Reed Mouthpiece Brush, Key Oil, Polishing Cloth.

**HE106** Complete Kit.....**\$19.41**

### SAXOPHONE

Contains: Cork Grease, Neck Cleaner, Sawb, Key Oil, Reed Mouthpiece Brush, Polishing Cloth.

**HE108** Complete Kit.....**\$21.76**

### TROMBONE

Contains: Wilwerk Slide Oil, Brass Mouthpiece Brush, Flexible Cleaner, "Spitballs" Cleaning Discs, Polishing Cloth.

**HE110** Complete Kit.....**\$22.47**

### FLUTE

Contains: 2 Flute Cleaning Rod Cloths, Flannel Cleaning Cloth, Cork Grease, Slide Grease, Wilwerk Key Oil, Cleaning Brush and Duster and Polishing Cloth.

**HE107** Complete Kit.....**\$18.45**



### BASS CLARINET CARE KIT

Wood Polish Cloth Tiger Rag Body Swab Superslick Cork Grease Superslick Key & Rotor Oiler Tiger Rag Neck Swab Mouthpiece Brush Double End Duster Brush Care Instructions.

**SSBCKK**.....**\$18.00**

### WOOD CLARINET CARE KIT

Wood Polish Cloth Hanky Swab Superslick Cork Grease Thumb Cushion Reedguard 2 Superslick Bore Oil Mouthpiece Brush Double End Duster Brush Care Instructions.

**SSWCCK**.....**\$20.70**

### COMPOSITION CLARINET CARE KIT

Untreated Polish Cloth, Clarinet/Flute Hanky Swab, Cork Grease, Reed Guard 2 cl/alto sax, FAXX Pad Dryer - 1 pc., Thumb Cushion, Woodwind Mpc Brush, Double End Duster Brush, Instructions.

**SSCCPK**.....**\$18.90**

### FLUTE CARE KIT

Untreated Polishing Cloth, Flute Thumb Positioner, FAXX Pad Dryer - 1 pc., Double End Snake/Swab, Double End Duster Brush, Instructions.

**SSFCK3**.....**\$14.40**

### PICCOLO CARE KIT

Treated Polish Cloth, Silk Body Swab, FAXX Pad Dryer - 1 pc., Key & Rotor Oiler, Double End Duster Brush, Instructions.

**SSPCK**.....**\$16.20**

### OBOE CARE KIT

Untreated Polish Cloth, Oboe Swab Set (2 pc.), Cork Grease, FAXX Reedguard 2 oboe, FAXX Pad Dryer - 1 pc., Thumb Cushion, Double End Duster Brush, Instructions.

**SSOCKP**.....**\$18.90**

### BARITONE SAX CARE KIT

Untreated Polish Cloth, Cork Grease, Rico Reedgard 2 T/Bsx, FAXX Pad Dryer - 1 pc., Double End Duster Brush, Mouthpiece Brush, Flexible Crook Swab, Instructions.

**SSBSCK2**.....**\$24.30**

### LOW BRASS CARE KIT

Untreated Polish Cloth, Valve Oil 1.25 oz., Tuning Slide Grease, Vinyl Cleaning Snake, Brass Mpc Brush, Lg. Valve Casing Brush, Instructions.

**SSBHCKL**.....**\$18.90**

### CELLO CARE KIT

Untreated Polish Cloth, Dark Rosin, Luthier's Choice Peg Compound, Endpin Rubber Stopper Tip, Instructions.

**SSCECK2**.....**\$14.40**



# PLAYERS CARE KITS



## PICCOLO - FLUTE

Contains: Cork Grease; Rod Cleaning Cloths; Polishing Cloth; Cleaning Brush; Fingering Chart; Use & Care Pamphlet; Decal & Case Lid; Tuning & Instruction Tape.

<b>MKHFL</b> Ziplock bag.....	<b>\$17.75</b>
<b>MKBFL</b> Clamshell box.....	<b>18.75</b>
<b>MKHFSS</b> Super Saver.....	<b>13.85</b>

## TRUMPET

Contains: Valve Oil; Lacquer Polishing Cloth; Trumpet Snake; Mouthpiece Brush; Spit Corks; Tuning Slide Grease; Valve Brush; Fingering Chart; Use & Care Pamphlet; Decal & Case ID; Tuning & Instruction Tape.

<b>MKHTR</b> Ziplock bag.....	<b>\$21.75</b>
<b>MKBTR</b> Clamshell box.....	<b>22.75</b>
<b>MKHTRSS</b> Super Saver.....	<b>15.45</b>

## FRENCH HORN

Contains: Rotor Oil; Lacquer Polishing Cloth; French Horn Snake; Mouthpiece Brush; Tuning Slide Grease; Replacement Rotor Strings; Duster Brush; Use & Care Pamphlet; Decal & Case ID.

<b>MKHFH</b> Ziplock bag.....	<b>\$21.75</b>
<b>MKHFHSS</b> Super Saver.....	<b>19.75</b>

## COMP. CLARINET

Contains: Rainbow Clarinet Swab; Cork Grease; Duster Brush; Mouthpiece Brush; Polishing Cloth; Thumb Rest Cushions; Fingering Chart; Use & Care Pamphlet; Decal & Case ID; Tuning & Instruction Tape.

<b>MKHCC</b> Ziplock bag.....	<b>\$18.75</b>
<b>MKBCC</b> Clamshell box.....	<b>19.75</b>
<b>MKHCCSS</b> Super Saver.....	<b>15.45</b>

## SILVER TRUMPET

<b>MKHST</b> Ziplock bag.....	<b>\$22.75</b>
-------------------------------	----------------

## SILVER LOW BRASS

<b>MKHSB</b> Ziplock bag.....	<b>\$23.75</b>
<b>MKBSB</b> Clamshell box.....	<b>24.75</b>
<b>MKHSBSS</b> Super Saver.....	<b>20.75</b>

## BANDSTAND KITS

<b>BSK2</b> Flute.....	<b>\$11.00</b>
<b>BSK4</b> Comp Clarinet.....	<b>14.00</b>
<b>BSK8</b> Trumpet.....	<b>18.50</b>
<b>BSK12</b> Saxophone.....	<b>18.50</b>

## DAMPITS



Moisture added devices for woodwinds.

<b>PITRC</b> Reed Case.....	<b>\$16.00</b>
<b>PITCL1</b> Oboe/Clar., 1st joint.....	<b>17.00</b>
<b>PITCL2</b> Alto Clar., Eng. Horn, Clar. 2nd joint.....	<b>17.00</b>
<b>PITBJ</b> Bassoon Bell Joint.....	<b>20.00</b>
<b>PITWJ</b> Bassoon Wing Joint.....	<b>19.00</b>
<b>PITBC</b> Bass Clarinet.....	<b>19.00</b>

## WOOD CLARINET

Contains: Rainbow Clarinet Swab; Cork Grease; Duster Brush; Mouthpiece Brush; Polishing Cloth; Thumb Rest Cushions; Bore Oil; Cotton Brush Swab; Fingering Chart; Use & Care Pamphlet; Decal & Case ID; Tuning & Instruction Tape.

<b>MKHWC</b> Ziplock bag.....	<b>\$20.75</b>
<b>MKHWCSS</b> Super Saver.....	<b>18.75</b>

## TROMBONE

Contains: Slide Oil; Polishing Cloth; Trombone Snake; Mouthpiece Brush; Spit Corks; Tuning Slide Grease; Fingering Chart; Use & Care Pamphlet; Decal & Case ID; Tuning & Instruction Tape.

<b>MKHTB</b> Ziplock bag.....	<b>\$19.75</b>
<b>MKBTB</b> Clamshell box.....	<b>20.75</b>
<b>MKHTBSS</b> Super Saver.....	<b>15.45</b>

## MARCHING HORNS

(MELOPHONE/FLUGEL/F-HORN/T-BONE)

Contains: Valve Oil; Polishing Cloth; Marching Horn Snake; Mouthpiece Brush; Tuning Slide Grease; Valve Brush; Spit Corks; Use & Care Pamphlet; Decal & Case ID.

<b>MKMHM</b> Ziplock bag.....	<b>\$22.75</b>
-------------------------------	----------------

## VIOLIN

Contains: Shoulder Rest; Rosin; Polishing Cloth; Fingering Markers; MagicTouch Violin Polish; Fingering Chart; Use & Care Pamphlet; Decal & Case ID; Tuning & Instruction Tape.

<b>MKHVI</b> Ziplock bag.....	<b>\$22.75</b>
<b>MKBVI</b> Clamshell box.....	<b>23.75</b>

## DRUM

Contains: Drum Key; MagicTouch Cymbal Polish; Polishing Cloth; Multi-Purpose Grease; Deadbeat Impact Pad; Deadbeat 24" Felt Strip; Cymbal Felts; Snare Strings; Tension Washers; Vinyl Replacement Tips; Cymbal Sleeves; Rudimental Chart; Use & Care Pamphlet; Decal & Case ID; Tuning & Instruction Tape.

<b>MKHDR</b> Ziplock bag.....	<b>\$24.50</b>
-------------------------------	----------------

## SAXOPHONE

Contains: Rainbow Sax Swab; Cork Grease; Rainbow Sax Neck Cleaner; Polishing Cloth; Mouthpiece Brush; Duster Brush; Fingering Chart; Use & Care Pamphlet; Decal & Case ID; Tuning & Instruction Tape.

<b>MKHSX</b> Ziplock bag.....	<b>\$20.75</b>
<b>MKBSX</b> Clamshell box.....	<b>21.75</b>
<b>MKHSXSS</b> Super Saver.....	<b>15.45</b>

## LOW BRASS

<b>MKHLB</b> .....	<b>\$22.75</b>
--------------------	----------------

## MICROFIBER SWABS

<b>MFZSX</b> Alto-Tenor (Zigzag).....	<b>\$9.45</b>
<b>MFSSX</b> Alto-Tenor (Stitched).....	<b>10.25</b>
<b>MFSCS</b> Clarinet Swab (Stitched).....	<b>7.85</b>

## MICROFIBER CLOTHS

<b>MFZL</b> 12" x 12" Zigzag Edge.....	<b>\$6.50</b>
<b>MFSS</b> 7" x 11" Stitched Edge.....	<b>5.85</b>
<b>MFCSL</b> 12" x 12" Stitched Edge.....	<b>7.85</b>

## MASTER SERIES

### FLUTE

Contains: Silver Cloth; Cork Grease - Stick; Duster Brush; Rod Cloths; Key Oil; Deluxe Cordura Case.

<b>PMSFL</b> .....	<b>\$30.00</b>
--------------------	----------------

### TRUMPET

Contains: Snake; Valve Oil; Two-Step Brush - Small; Tuning Slide Grease; Lacquer Polishing Cloth; Valve Brush; Deluxe Cordura Case.

<b>PMSTR</b> .....	<b>\$30.00</b>
--------------------	----------------

### SAXOPHONE

Contains: Swab; Cork Grease; Woodwind MP Brush; Double Ended Neck Cleaner; Duster Brush; Polishing Cloth; Key Oil; Deluxe Cordura Case.

<b>PMSX</b> .....	<b>\$30.00</b>
-------------------	----------------

### FRENCH HORN

Contains: 5' Snake; Two-Step Brush - Small; Tuning Slide Grease; Rotor Oil; Lacquer Polishing Cloth; Extra Rotor String; Deluxe Cordura Case.

<b>PMSFH</b> .....	<b>\$30.00</b>
--------------------	----------------

### VIOLIN A

Contains: Rosin; Polishing Cloth; MagicTouch Polish; Chin Rest Tool; Foam App. Pad; Peg Dope; Duster Brush; Deluxe Cordura Case.

<b>PMSVI</b> .....	<b>\$30.00</b>
--------------------	----------------

### VIOLIN B

Contains: Rosin; Polishing Cloth; MagicTouch Polish; Chin Rest Tool; Foam App. Pad; Peg Dope; Duster Brush; String Cleaners; Deluxe Cordura Case.

<b>PMSOVI</b> .....	<b>\$23.50</b>
---------------------	----------------

## YAMAHA CARE KITS

**YACFLKIT** Flute/Piccolo.....**\$21.99B**  
Consisting of one each: Polishing Cloth; Pad Papers; Owner's Manual, Tone Hole Cleaner.

**YACLKIT** Resin Clarinet.....**\$24.99B**  
Consisting of one each: Cork Grease, soft; Tone Hole Cleaner; Pad papers, Cleaning; Clarinet Swab; Woodwind Mouthpiece Brush; Untreated Polishing Cloth.

**YACOBKIT** Oboe.....**\$27.99B**

**YACLBPKIT** Low Brass, Piston.....**27.99B**  
Consisting of one each: Premium Rotor Oil; Lever Oil; Tuning Slide Grease; Flexible Cleaning Brush; Brass Mouthpiece Brush; Untreated Polishing Cloth.

**YACSAXKIT** Saxophone.....**\$27.99B**  
Consisting of one each: Swab; Mouthpiece Brush; Cork Grease; Polishing Cloth; Pad Papers; Owner's Manual, Tone Hole Cleaner.

**YACTRKIT** Trumpet/Cornet.....**\$27.99B**  
Consisting of one each: cleaner; Mouthpiece Brush; Valve Casing Brush; Polishing Cloth; Valve Oil; tuning Slide Grease; Owner's Manual.

**YACSLKIT** Trombone.....**\$25.99B**  
Consisting of one each: Cleaner; Mouthpiece Brush, Slide Cream, Spray Bottle; Slide Grease; Polishing Cloth.

**YACHRKIT** French Horn.....**\$31.99B**  
Consisting of one each: Mouthpiece Brush; Vinyl Coated Cleaner; Rotor Oil; Rotor Spindle Oil; Lever Oil; Slide Grease; Yellow Rotor String; Polishing Cloth; Owner's Manual.

# SELMER



## CARE KITS

### TRUMPET/CORNET CARE KIT.

Bore cleaner coil, mouthpiece brush, cleaning rod, cleaning cloth, valve oil, tuning slide/cork grease and polishing cloth.

**S366T** .....\$27.00  
**S2960P** Plated .....28.85

### SINGLE/DOUBLE HORN CARE KIT.

Bore coil, mouthpiece brush, cleaning cloth, rotary valve oil, tuning slide/cork grease and polishing cloth.

**S366H** .....\$31.00

### TROMBONE CARE KIT.

Slide cleaner coil, mouthpiece brush, liquid slide cream, tuning slide/cork grease and polishing cloth.

**S366B** .....\$30.00

### SAXOPHONE CARE KIT.

Swab, mouthpiece brush, neck cleaner, cleaning brush/duster, cork grease, key oil and polishing cloth.

**S366S** .....\$27.00

### WOOD CLARINET CARE KIT.

Mouthpiece brush, cleaning brush/duster, Dri-Bore swab, bore oil, cork grease, key oil and polishing cloth.

**S366W** .....\$26.00

### FLUTE/PICCOLO CARE KIT.

Cleaning brush/duster, two cleaning cloths, key oil and polishing cloth.

**S366F** .....\$30.00

### RESONITE®/PLASTIC CLARINET CARE KIT.

Swab, mouthpiece brush, cleaning brush/duster, cork grease, key oil and polishing cloth.

**S366C** .....\$22.70

### TUBA/SOUSA CARE KIT.

Mouthpiece brush, mouthpiece pouch, cleaning cloth, valve oil and tuning slide/cork grease.

**S366L** .....\$31.00

### MAINTENANCE KIT.

Bach Stradivarius trumpet maintenance kit contains the most common trumpet repair parts such as valve springs, valve felts, stem felts, etc.

**S1877** .....\$45.00

### POLISHING GLOVES.

**S1889** Bach polishing gloves for lacquered instruments .....\$15.00

## LUBRICANTS

### SELMER

**S2922SG** Trombone Slide Cream, Liquid .....\$5.00  
**S2936SG** No-stick Powder .....5.00  
**S2942BSG** Tuning Slide .....5.20



### BACH

**S1885SG** Valve oil .....\$5.00  
**S1887SG** Tuning slide grease .....6.00  
**S1881SG** Slide cream additive .....5.00  
**S1880SG** Trombone slide cream .....5.00  
**S1886SG** Rotary oil .....8.00  
**S1883** Trombone slide kit contains:  
 1 ea., S1880, S1881 and S1882....15.05



## ACCESSORIES

### BACH DELUXE POLISHING CLOTHS.

**S1878** .....\$10.00

### CLEANING CLOTHS.

Bleached cotton, lint free.  
**S2975** 17½" x 18" .....\$6.00  
**S2976** 10" x 17½" .....5.00

### SILVER POLISHING GLOVES.

**S1888** Bach .....\$15.00  
**S2950** Selmer .....15.00

### SELMER METAL POLISH.

**S2979** .....\$5.00

### SELMER CREAM LACQUER POLISH.

**S2977** .....\$5.00

### SELMER POLISHING CLOTHS.

**S2952** for lacquer finishes.....\$6.00  
**S2955** for plated finishes .....6.00



### CLARINET SWABS.

**S2944** (Dri-Bore) .....\$4.00  
**SZ2944** (Dri-Bore) .....47.00/dz  
**S2947** Alto, bass, or contrabass.....5.00  
**S375** Selmer cloth swab .....8.00

### SAXOPHONE SWABS.

**S465** Le Pactole swab .....\$7.00  
**S465S** With a sponge center .....7.00

### OBOE SWABS.

**S5573** Set of two (large and small).....\$10.00

### BASSOON SWAB

**S779** Selmer cloth swab .....\$10.00

## SLIDE O MIX



CG337

Advanced lubrication system for trombone slides.

**CG337** Slide-O-Mix .....\$19.00  
**CG337SBR** Regular, 10 ml .....10.00  
**CG337LBR** Regular, 50 ml .....10.00  
**CG337L** Slide-O-Mix Light .....19.00  
**CG337SBL** Light, 10 ml .....10.00  
**CG337LBL** Light, 50 ml .....10.00  
**CG337RC** Rapid Comfort, 30 ml .....10.00



## VENTURE

### TRUMPET

Premium valve oil, slide grease, brass mouthpiece brush, valve casing brush, vinyl trumpet cleaner, polishing cloth, ID tag, instructions.

**V350** .....\$12.00

### TROMBONE

Premium slide oil, slide grease, brass mouthpiece brush, vinyl T-bone cleaner, polishing cloth, ID tag, instructions.

**V355** .....\$12.00

### COMPOSITION CLARINET

Clarinet swab, reed mouthpiece brush, duster brush, premium cork grease, polishing cloth, reed holder, ID tag, instructions.

**V360** .....\$12.00

### SAXOPHONE

Premium cork grease, duster brush, polishing cloth, reed holder, reed mouthpiece brush, sax neck cleaner, ID tag, instructions.

**V375** .....\$12.00

### LOW BRASS

Premium valve oil, slide grease, brass mouthpiece brush, vinyl T-bone cleaner, polishing cloth, ID tag, instructions.

**V381** .....\$12.00

### FLUTE

Flute swab, duster brush, flute lube, polishing cloth, ID tag, instructions.

**V380** .....\$12.00

## HETMAN

### PISTON VALVE – WITH DROPPER TIP

**A14MW10** Light Piston Valve #1 .....\$7.00B  
**A14MW20** Piston Valve #2 .....7.00B  
**A14MW30** Classic Piston Valve #3 .....7.00B

### TUNING SLIDE – WITH NOZZLE TIP

**A14MW40** Tuning Slide #5 .....\$6.00B  
**A14MW41** Light Tuning Slide #4 .....6.00B  
**A14MW42** Heavy Tuning Slide #6 .....6.00B

### TUNING SLIDE – GREASE

**A14MW50** Tuning Slide Gel #7 .....\$7.00B  
**A14MW55** Slide Gel Plus #7P .....7.00B  
**A14MW60** Tuning Slide Grease #8 .....6.00B

### MULTI-PURPOSE GREASE

**A14MW65** 10cc in a tub #10 .....\$7.00B

### ROTARY VALVE

**A14MW70** Rotor #12 .....\$7.00B  
**A14MW71** Light Rotor #11 .....7.00B  
**A14MW72** Med. Rotor #11.5 .....7.00B  
**A14MW80** Light Bearing #13 .....7.00B  
**A14MW85** Medium Bearing #13.5 .....7.00B  
**A14MW90** Bearing and Linkage #14 .....7.00B  
**A14MW100** Ball Joint #15 .....7.00B

### TROMBONE SLIDE

**A14MW180** Hydro Spray Concentrate #20 .....\$6.00B  
**A14MW181** Hydro Spray Bottle .....4.00B

### WOODWIND

**A14MW110** Light Key #16 .....\$7.00B  
**A14MW120** Medium Key #17 .....7.00B  
**A14MW125** Heavy Key #18 .....7.00B  
**A14MW130** Cork Lubricant #19 .....7.00B

## ULTRA PURE OILS/ CARE KITS

<b>UPOV</b>	Prof. Valve Oil, 2oz./59ml.....	<b>\$6.95</b>
<b>UPOULV</b>	Ultra-Light Valve Oil, 2oz./59ml.....	<b>7.99</b>
<b>UPORFL</b>	Prof. Valve Oil, 8oz. Refill.....	<b>20.00</b>
<b>UPOREG</b>	Regular Tuning Slide Lube, 9 ml.....	<b>3.50</b>
<b>UPOLITE</b>	Light Tuning Slide Lube, 9ml.....	<b>3.50</b>
<b>UPOHVV</b>	Heavy Tuning Slide Lube, 9ml.....	<b>3.95</b>
<b>UPOTSCG</b>	Tuning Slide/Cork Grease, 4.25g.....	<b>3.50</b>
<b>UPOTROM</b>	Trombone Slide Lube, 1oz./30ml.....	<b>6.50</b>
<b>UPOMIST</b>	Trombone Mini Mist.....	<b>3.98</b>
<b>UPOLBO</b>	Light Bearing Oil, 20ml.....	<b>5.95</b>
<b>UPOLLK</b>	Linkage, Lever and Key Oil, 20ml.....	<b>5.95</b>
<b>UPOTPTKIT</b>	Deluxe Trumpet Care Kit.....	<b>23.95</b>
<b>UPOTROMKIT</b>	Deluxe Trombone Care Kit.....	<b>23.95</b>
<b>UPOHORNKIT</b>	Deluxe French Horn Care Kit.....	<b>29.95</b>
<b>UPOLOWBKIT</b>	Deluxe Low Brass Care Kit.....	<b>23.95</b>
<b>UPOCB</b>	Extra Large Microfiber Polishing Cloth, Blue.....	<b>7.95</b>
<b>UPOCG</b>	Extra Large Microfiber Polishing Cloth, Grey.....	<b>7.95</b>

## HOLTON



<b>VOH3250</b>	Valve Oil, 1.6 oz.....	<b>\$4.50</b>
<b>SOH3255</b>	Slide Oil, 1.6 oz.....	<b>4.00</b>
<b>ROH3261</b>	Rotary Oil, 1.4 oz.....	<b>4.85</b>
<b>3288</b>	LeBlanc Slid-Eze.....	<b>2.45</b>

## TUBE CORK GREASE



<b>YACCGS</b>	Yamaha, Synthetic.....	<b>\$11.99</b>
<b>YAC1010P</b>	Yamaha, Carded.....	<b>3.99</b>
<b>SS4020</b>	Super Slick.....	<b>1.70</b>
<b>CG100</b>	(Vandoren).....	<b>3.05</b>
<b>HE72</b>	Herco.....	<b>2.13</b>
<b>MIC6065</b>	Micro.....	<b>7.20</b>
<b>V265</b>	Venture.....	<b>1.05</b>
<b>CG4107</b>	Conn.....	<b>4.00</b>
<b>LTCC</b>	Rico.....	<b>2.41</b>
<b>3286</b>	Vito.....	<b>2.05</b>
<b>S2929SG</b>	Selmer.....	<b>3.00</b>

## ROCHE-THOMAS



<b>RT12</b>	Valve Oil, 16 oz.....	<b>\$11.25</b>
<b>RT18</b>	Premium Valve/Slide Oil 2 oz.....	<b>4.95</b>
<b>RT34</b>	Slide Cream, 1 oz.....	<b>4.00</b>
<b>RT47</b>	Tuning Slide Grease, 4 grams.....	<b>3.25</b>
<b>RT62</b>	Key Oil.....	<b>4.95</b>

## MISC. WOODWIND

<b>VOS</b>	Valve Oil.....	<b>\$3.55</b>
<b>MIC7203</b>	Bore Oil.....	<b>5.00</b>
<b>HE451</b>	Herco Key Oil.....	<b>4.25</b>
<b>S3280</b>	Ke-Bor Clarinet Oiling Kit.....	<b>19.00</b>
<b>DW4930</b>	Wick Valve Oil.....	<b>12.99</b>
<b>BBO</b>	Berp Bio Oil.....	<b>7.50</b>
<b>BSL</b>	Bell's Super Lube.....	<b>6.00</b>
<b>BBG</b>	Berd Bio Grease.....	<b>5.95</b>

## BLUE JUICE



<b>BJ 2</b>	2 oz.....	<b>\$5.36B</b>
<b>BJ 8</b>	8 oz.....	<b>14.96B</b>

## WOODWIND ALL



<b>WW345</b>	Pad and Bore Formula.....	<b>\$12.85</b>
--------------	---------------------------	----------------

## SPRAY BOTTLES



<b>SS4236</b>	Super Slick.....	<b>\$2.25</b>
<b>RT41</b>	Bone Bottle.....	<b>3.00</b>

## SUPER SLICK



<b>SS4001</b>	Valve Oil, 2 oz.....	<b>\$3.00</b>
<b>SS4125</b>	Valve Oil, 1.25 oz.....	<b>2.35</b>
<b>TSO</b>	Slide Oil, 2 oz.....	<b>3.95</b>
<b>TSOQ</b>	Slide Oil, 1.25 oz.....	<b>2.25</b>
<b>SSKOQ</b>	Key Oil, 1.25 oz. w/dropper tip, spout cap.....	<b>3.00</b>
<b>SS4020</b>	Cork Grease, 1/4 oz.....	<b>1.70</b>
<b>SS4234</b>	Tuning Slide Grease, 1/2 oz.....	<b>2.25</b>
<b>SS4230</b>	Trombone Cream, 2/3 oz.....	<b>3.00</b>
<b>SS4050</b>	Key/Rotor w/Pin Oiler.....	<b>6.00</b>
<b>SS4060</b>	Bore Oil.....	<b>2.55</b>
<b>SS4233</b>	Plus Slide Treatment.....	<b>3.85</b>
<b>SS4240</b>	Slickits.....	<b>8.10</b>

## SHOP SIZE OILS & GREASE

<b>SSVO216</b>	Valve Oil - in 16oz bottle w/dropper tip, spout cap and VO2.....	<b>\$23.40</b>
<b>SSTSO16</b>	Slide Oil - in 16 oz. bottle w/dropper tip, spout cap & TSO.....	<b>24.30</b>
<b>SSTSG16</b>	Tuning Slide Grease - in 16 oz. container.....	<b>25.20</b>

## SPACEFILLER



<b>OILB</b>	Ultimate I (Blue) viscosity works best on most valves.....	<b>\$5.45</b>
<b>OILR</b>	Ultimate II (Red) thinner viscosity maximizes "tight" valves.....	<b>5.80</b>
<b>OILG</b>	Spacefiller TS (Green) (tuning slide).....	<b>5.45</b>

## CONN



<b>CG338</b>	Trombotine.....	<b>\$9.00</b>
<b>VO4101</b>	Valve Oil.....	<b>5.00</b>
<b>SO4102</b>	Slide Oil.....	<b>5.00</b>
<b>RO4103</b>	Rotor Oil.....	<b>5.00</b>
<b>KO4104</b>	Key Oil.....	<b>5.00</b>
<b>BO4105</b>	Bore Oil.....	<b>5.00</b>

## BELMONTE

<b>5145</b>	Valve Oil, 2 oz.....	<b>\$2.95</b>
<b>5146</b>	Slide Oil, 2 oz.....	<b>2.95</b>
<b>6123</b>	Bore Oil, 2 oz.....	<b>2.95</b>
<b>6124</b>	Key Oil, 2 oz.....	<b>2.95</b>
<b>5186</b>	Slide Grease.....	<b>2.30</b>

## AL CASS



<b>2740</b>	2 oz. Al Cass Oil.....	<b>\$6.55</b>
-------------	------------------------	---------------

## SLIDE GREASE

<b>BSG</b>	Bell's Super Grease.....	<b>\$5.35</b>
<b>MPGS</b>	Players.....	<b>2.45</b>
<b>MIC7352</b>	Micro Slide Glide.....	<b>6.00</b>
<b>VTS</b>	Venture Slide Grease.....	<b>1.05</b>
<b>S2942BSG</b>	Selmer, Tuning Slide.....	<b>6.00</b>
<b>USSG</b>	Dr. Dan's Ultra Smooth.....	<b>6.95</b>
<b>SCSSG</b>	Schilke Slide Grease.....	<b>5.75B</b>
<b>YAC1011P</b>	Yamaha.....	<b>3.99</b>
<b>YACSGS</b>	Yamaha Synthetic Stick.....	<b>11.99</b>
<b>YACSGRC</b>	Yamaha Synthetic Tube.....	<b>11.99</b>
<b>HE91</b>	Herco Slide Grease.....	<b>2.67</b>

## CORK GREASE



<b>MIC6063</b>	(Micro) Box.....	<b>\$2.55</b>
<b>YAC1007P</b>	Yamaha, Round.....	<b>4.99</b>

## ALISYN



<b>PN2190</b>	Cork-Tuning Slide Grease.....	<b>\$4.95</b>
<b>PN2090</b>	Valve, Slide, Key Oil.....	<b>3.95</b>
<b>PN2290</b>	Bore Oil.....	<b>3.95</b>
<b>PN2390</b>	Solvent.....	<b>4.95</b>
<b>PN2490</b>	Key Oil, Heavy Duty.....	<b>3.95</b>

## YAMAHA



<b>YAC1006P</b>	Bore oil, 40 ml.....	<b>\$12.99</b>
<b>YAC100412</b>	Bore oil, 1.5 oz.....	<b>3.95</b>
<b>YACLVO</b>	Light valve oil, 38 ml.....	<b>11.99</b>
<b>YACRVO</b>	Regular valve oil, 38 ml.....	<b>11.99</b>
<b>YACVVO</b>	Vintage Valve oil, 38 ml.....	<b>11.99</b>
<b>YACRO</b>	Rotor oil, 20 ml.....	<b>14.99</b>
<b>YACLKO</b>	Synthetic key oil light.....	<b>14.99</b>
<b>YACMKO</b>	Synthetic key oil medium.....	<b>14.99</b>
<b>YACHKO</b>	Synthetic key oil heavy.....	<b>14.99</b>
<b>YACRO</b>	Synthetic rotor oil.....	<b>14.99</b>
<b>YAC1013P</b>	Rotor Spindel Oil.....	<b>13.99</b>
<b>YAC1015P</b>	Recorder cream.....	<b>3.99</b>
<b>YAC1021P</b>	Slide oil.....	<b>10.99</b>
<b>YACTSO</b>	Synthetic tune slide oil.....	<b>14.99</b>
<b>YAC1020P</b>	Slide cream.....	<b>11.99</b>
<b>YAC101410</b>	Lever Oil.....	<b>13.99</b>

## VENTURE

<b>V101</b>	Slide Oil, 1 1/4 oz.....	<b>\$1.50</b>
<b>V102</b>	Valve, 1 1/4 oz.....	<b>1.35</b>
<b>VTS</b>	Tuning Slide Grease.....	<b>1.05</b>

## SELMER STRAPS



**RAY HYMAN SUPER SLING SAXOPHONE STRAPS**  
Nylon web, hook and slide. Wide band for extra comfort.

**S7942B** Alto/Tenor Saxophone, black.....**\$20.00**  
**S7943B** Baritone Saxophone, black.....**20.00**

**RAY HYMAN SLIMLINE SAX STRAP**  
**S7946B** .....**\$17.00**

**SELMER PADDED SAXOPHONE NECK STRAP**  
Comfortable 1" wide nylon webbing strap with soft velour neck pad. Scratch resistant swivel snap hook and adjusting slide. Black.

**S477** Alto/Tenor padded saxophone neck strap.....**\$15.00**  
**S480** Coated Metal Hook.....**22.00**



**SELMER HARMONY CLARINET NECK STRAPS**  
Black neck band with matching nylon cord. Will not twist.

**S7928** Alto Clarinet two nickel plated hooks.....**\$27.00**  
**S7929** Bass Clarinet two nickel plated hooks .....**27.00**

**BASSOON NECK AND SEAT STRAPS**  
**S563B** Neck strap.....**\$16.00**  
**S786** Seat strap.....**32.00**

**SELMER WEB SAXOPHONE NECK STRAP**  
**S564** Alto/Tenor.....**\$8.00**

**SELMER CORD SAXOPHONE NECK STRAP**  
**S479** Alto/Tenor saxophone, Black.....**\$8.00**

**SELMER OEM PADDED SAXOPHONE NECK STRAP**  
**S7950** Alto/Tenor padded .....**\$25.00**

## CLARICORD STRAP



**DEG CLARINET STRAP**  
**A12CL100** .....**\$24.00**  
LM Clarinet Strap  
**IA41BK** .....**6.00**

## LM STRAPS



**IA19** Sax Black, Padded.....**\$12.75**  
**IA41BK** Clarinet.....**6.00**  
**IA24** Bass Clarinet .....**9.00**

## REPAIR TOOL



Removes dents from mouthpiece shank.  
**DEGTT995** .....**\$27.00B**  
**700051**.....**42.75**

## SLIDE SAVER



Prevents dents & nicks in Trombone outside slide tubes. A must for rental horns.  
**DEGSS1** .....**\$8.00**  
**DEGSS2** Collar Protector.....**3.00**  
**TBGBK** Neotech TBone Grip .....**32.95**  
**DEGSE495** Slide Extension .....**17.00B**  
**A08TSP** Trombone Slide Bow Projector.....**6.00**  
**(W) (PU) (BK)**

## VALVE PROTECTORS



**TRUMPET**  
**B3485** Black.....**\$11.85**  
**3324BK** Black .....**11.60**  
**2110T** Trumpet, Black, Lace.....**10.10**  
**2100T** Trumpet, Black, Velcro .....**8.70**  
**IAIBK** Trumpet, Leather, Velcro .....**9.00**  
**HE80** Trumpet, Clear Vinyl.....**5.59**  
**TRO1800** Trumpet, Leather.....**12.50**  
**805LV** Trumpet, Leather Velcro.....**16.35**  
**HE82** Trumpet, Leather, Velcro .....**8.58**  
**MIC4000** Trumpet, Leather, Velcro .....**6.25**  
**IA13BK** Trumpet, Black, Leather, Lace .....**9.00**  
**BWT** Trumpet, Wrap .....**7.50**

**FRENCH HORN**  
**BWFH** French Horn.....**7.50**  
**3486** Black, French Horn.....**23.20**  
**IA12** French Horn, Lace.....**9.00**  
**IA22** French Horn, Velcro.....**9.00**  
**2500F** French Horn, Black.....**14.50**  
**BWLFH** French Horn, Wrap.....**9.95**

**BACH VALVE GUARDS**  
**S8311T** Trumpet, Tan Leather.....**\$11.00**  
**S8311B** Trumpet, Black Leather.....**11.00**  
**S8311TV** Trumpet, Tan Leather Velcro .....**11.00**  
**S8311BV** Trumpet, Black Leather Velcro .....**11.00**

**TROMBONE GRIP™**  
Supports the weight of a trombone while maintaining the proper playing position. It's designed to be adjusted to fit both the instrument and the musician's hand.  
**TBGBK**.....**\$32.95**

## MARCHING GLOVES



White cotton glove with triple ribbed back. Plain palm and finished tip without snaps. Available in small, medium and large sizes. Packed one dozen per box and sold only in dozens.

**1001 (S) (M) (L)**.....**\$42.00**

White cotton glove with triple ribbed back. Palms are beaded with PVC to facilitate grip. Finished top without snaps. Available in small, medium and large. Packed one dozen per box and sold in dozens only.

**1002 (S) (M) (L)**.....**\$45.00**

White nylon glove with plain palm. Nylon provides the advantage of one size fits all. Triple ribbed back with finished tip without snaps. Packed one dozen per box and sold in dozens only.

**1003 (one size fits all)**.....**\$48.00**

## BASSOON SEAT STRAPS



**NBSS** Neotech, Black Neoprene.....**\$32.95**  
**6562** Black, Leather cup/Nylon Strap.....**21.90**  
**2700B** Ft. Bryan, cup, Leather .....**40.20**  
**GBSS** Gem, Nylon .....**14.00**  
**3346** White; Bassoon Seat, Leather.....**50.25**  
**3499** Black; Bassoon Seat, Leather.....**44.85**  
**S786** Selmer, Brown w/hook.....**32.00**

## BELMONTE STRAPS



**LEATHER STRAPS**  
**3476** Black; Alto/Tenor.....**\$15.50**  
**3475** Black; Tenor/Bari.....**29.65**  
**3488** Black; Bass/Clarinet.....**13.10**  
**3489** Black; Bassoon.....**13.85**

# NEOTECH WOODWIND/BRASS STRAPS & HARNESSSES

Learn more at [www.neotechstraps.com](http://www.neotechstraps.com)

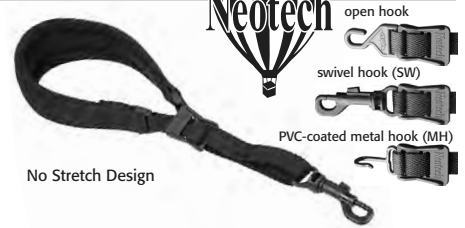
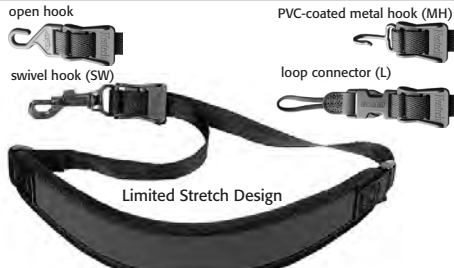
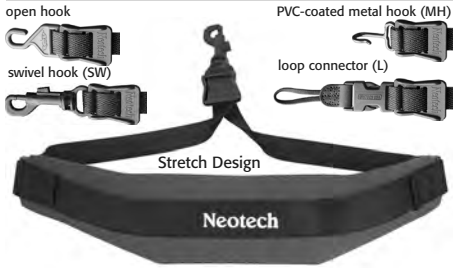

**SOFT SAX STRAP®** Neoprene pad with Comfort Stretch. Available in (\*BK) black, (\*R) red, (\*NB) navy blue, (\*RB) royal blue, (\*G) green, (\*W) wine with open hook, swivel hook, or PVC-coated metal hook.

<b>SSR *</b>	Regular, Open Hook.....	<b>\$20.95</b>
<b>SSR * SW</b>	Regular, Swivel Hook.....	<b>23.15</b>
<b>SSR * MH</b>	Regular, Metal Hook.....	<b>22.00</b>
<b>SSJR * SW</b>	Junior, Swivel Hook.....	<b>23.25</b>
<b>SSXLBL</b>	XL, Open Hook.....	<b>22.00</b>
<b>SSXLBKSW</b>	XL, Swivel Hook.....	<b>24.25</b>
<b>SSXLBKMK</b>	XL, Metal Hook.....	<b>23.25</b>

(insert color at \*)

**CLASSIC STRAP™** Neoprene pad with Control Stretch binding. Available in (\*BK) black, (\*R) red, (\*RB) royal blue, (\*G) green, with open hook, swivel hook, PVC-coated metal hook or loop connector.

<b>CS *</b>	Regular, Open Hook.....	<b>\$22.00</b>
<b>CS * SW</b>	Regular, Swivel Hook.....	<b>24.25</b>
<b>CS * MH</b>	Regular, Metal Hook.....	<b>23.25</b>
<b>CSBKL</b>	Regular, Loop Connector.....	<b>24.25</b>
<b>CSJR * SW</b>	Junior, Swivel Hook.....	<b>24.25</b>
<b>CSXLBK</b>	XL, Open Hook.....	<b>24.25</b>
<b>CSXLBKSW</b>	XL, Swivel Hook.....	<b>25.25</b>
<b>CSXLBKMH</b>	XL, Metal Hook.....	<b>24.25</b>
<b>CSXLBKL</b>	XL, Loop Connector.....	<b>24.25</b>
<b>CS2HBK</b>	2 Metal Hooks.....	<b>26.00</b>

(insert color at \*)

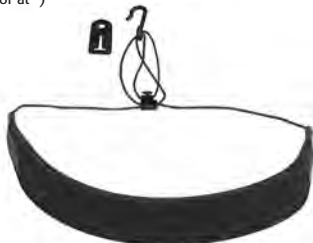

**C.E.O. (Clarinet, English horn, Oboe) COMFORT STRAP™** Slim neoprene pad with PVC-coated metal hook and polyurethane thumb tab. Available in (\*BK) black, (\*R) red, (\*NB) navy blue, (\*W) wine, or (\*G) green.

<b>CEO *</b>	Regular, Metal Hook.....	<b>\$17.95</b>
<b>CEOJR *</b>	Junior, Metal Hook.....	<b>\$17.95</b>
<b>CEOXLBK</b>	XL, Metal Hook.....	<b>\$18.95</b>

(insert color at \*)

**PAD-IT STRAP™** 2.5" wide non-stretch memory foam pad.

**WICK-IT SAX STRAP™** 1.5" wide non-stretch memory foam pad.

Available in black with open hook, swivel hook or PVC-coated metal hook.

<b>Pad-It Strap</b>		
<b>PITRBKSW</b>	Regular, Swivel Hook.....	<b>\$23.25</b>
<b>Wick-It Sax Strap</b>		
<b>WSRBKSW</b>	Regular, Open Hook.....	<b>18.95</b>
<b>WSRBKSW</b>	Regular, Swivel Hook.....	<b>20.95</b>
<b>WSRBKMH</b>	Regular, Metal Hook.....	<b>19.95</b>
<b>WSJRBKSW</b>	Junior, Swivel Hook.....	<b>20.95</b>
<b>WSXLBKSW</b>	XL, Swivel Hook.....	<b>22.00</b>
<b>WSXLBKMH</b>	XL, Metal Hook.....	<b>20.95</b>

## NEO SLING™



**NEO SLING™** over-the-shoulder sling with neoprene pad and control stretch. Black with swivel hook.

<b>NSRBKSW</b>	Regular, Swivel Hook.....	<b>\$24.25</b>
<b>NSXLBKSW</b>	XL, Swivel Hook.....	<b>\$25.25</b>

## UNIVERSAL STRAP & NEO-HOOK SYSTEM



**UNIVERSAL STRAP™** Neoprene pad compatible with **NEO HOOKS** interchangeable hooks.

<b>UNIVERSAL STRAP</b>			<b>NHRSW</b>	Reg, Swivel Hook.....	<b>\$9.95</b>
<b>USRSW</b>	Reg, Swivel Hook.....	<b>\$24.95</b>	<b>NHXLSMH</b>	XL Sling, Metal Hook.....	<b>10.95</b>
<b>NEO HOOKS</b>			<b>NHXLSSW</b>	XL Sling, Swivel Hook.....	<b>10.95</b>
<b>NHBS</b>	Bag Strap.....	<b>9.95</b>	<b>NHXLCMH</b>	XL, Cord, Metal Hook.....	<b>8.95</b>
<b>NHRCMH</b>	Reg, Cord, Metal Hook.....	<b>7.95</b>	<b>NHXLMH</b>	XL, Metal Hook.....	<b>8.95</b>
<b>NHRMH</b>	Reg, Metal Hook.....	<b>7.95</b>	<b>NHXLSSW</b>	XL, Swivel Hook.....	<b>10.95</b>
<b>NHRSMH</b>	Reg, Sling, Metal Hook.....	<b>9.95</b>	<b>NHRL</b>	Reg, Loop Connector.....	<b>9.95</b>
<b>NHRSSW</b>	Reg, Sling, Swivel Hook.....	<b>9.95</b>	<b>NHXLL</b>	XL, Loop Connector.....	<b>10.95</b>

## NEOTECH WOODWIND HARNESSSES

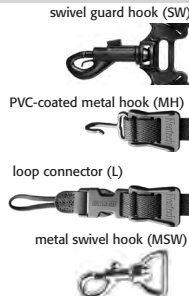

**SUPER HARNESS™** Neoprene yoke moves weight from neck to shoulders. Self-adjusting side-to-side positioning.

<b>SUHRBKSW</b>	Reg., Swivel Guard Hook.....	<b>\$45.25</b>
<b>SUHRBKMH</b>	Reg., Metal Hook.....	<b>45.25</b>
<b>SUHRBKL</b>	Reg., Loop Connector.....	<b>45.25</b>
<b>SUHRJRBKSW</b>	Junior, Swivel Guard Hook.....	<b>45.25</b>
<b>SUHRJRBKMH</b>	Junior, Metal Hook.....	<b>45.25</b>
<b>SUHRJRBKL</b>	Junior, Loop Connector.....	<b>45.25</b>
<b>SUHRXLBKSW</b>	XL, Swivel Guard Hook.....	<b>46.25</b>
<b>SUHRXLBKMH</b>	XL, Metal Hook.....	<b>46.25</b>
<b>SUHRXLBKL</b>	XL, Loop Connector.....	<b>46.25</b>

**SOFT HARNESS™** with neoprene shoulder pads.

<b>SHSBKSW</b>	Regular, Swivel Guard Hook.....	<b>\$38.50</b>
<b>SHSBKL</b>	Regular, Loop Connector.....	<b>38.50</b>
<b>SHSJRBKSW</b>	Junior, Swivel Guard Hook.....	<b>38.50</b>
<b>SHSXLBKSW</b>	XL, Swivel Guard Hook.....	<b>39.50</b>

**SIMPLICITY HARNESS™** Nylon webbing.

<b>SHJRPSW</b>	Jr./Reg., Plastic Swivel Hook.....	<b>\$32.95</b>
<b>SHJRMH</b>	Jr./Reg., Metal Hook.....	<b>31.95</b>
<b>SHJRMMSW</b>	Jr./Reg., Metal Swivel Hook.....	<b>32.95</b>
<b>SHXLPWSW</b>	XL, Plastic Swivel Hook.....	<b>33.95</b>
<b>SHXLMH</b>	XL, Metal Hook.....	<b>32.95</b>
<b>SHXLMMSW</b>	XL, Metal Swivel Hook.....	<b>33.95</b>

## NEOTECH BASSOON SEAT STRAP



**BASSOON SEAT STRAP™** with seat pad featuring non-skid surface backing & chair leg connectors.

<b>NBSS</b>	.....	<b>\$32.95</b>
-------------	-------	----------------

## NEOTECH BRASS STRAPS



**BRASS SLING™** with neoprene shoulder pad.

<b>BSLING</b>	Regular, Swivel Guard Hook.....	<b>\$24.95</b>
---------------	---------------------------------	----------------

**TUBA HARNESS™** with neoprene yoke. Multiple configurations to fit most tubas.

<b>THRBK</b>	Regular.....	<b>\$75.95</b>
<b>THJRBK</b>	Junior.....	<b>72.95</b>
<b>THXLBK</b>	XL.....	<b>75.95</b>

## SAX PRACTICE HARNESS

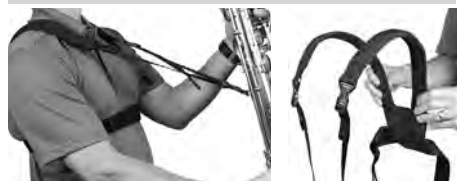

**SAX PRACTICE HARNESS™** features memory foam shoulder pads with internal aluminum supports and fully adjustable torso strap. Fully adjustable length and self-adjusting side-to-side positioning.

<b>SPHBKSW</b>	One Size, Swivel Hook.....	<b>\$89.95</b>
----------------	----------------------------	----------------

## ACE STRAPS



1315BK

Soft vinyl neck band. Coated hook, fully adjustable. Black.

**1202BK** Saxophone Strap .....\$7.70

Soft padded neck band with strong nylon string, adjustable slide and plastic hook. Black.

**1302BK** Alto Tenor Sax .....\$10.85

Strong nylon web with adjustable nylon slide and sturdy coated hook. Black.

**1315BK** Alto/Tenor Sax .....\$8.70



Ultra comfortable sax strap. Fully padded neckpiece, wide nylon, adjustable strap, sturdy hook. Black only.

**1605BK** .....\$8.85

**2400S** Black, Ft. Bryan .....\$13.15

## HW STRAPS



**HWSNSE** Ergo Sax .....\$19.95

**HWSNSEX** XL Ergo Sax .....\$19.95

## YAMAHA



**YAC1415P** Black, Sax .....\$8.00

**YAC1530P** Marching Tuba .....\$41.99

**YAC1435P** Aircell Bari Sax .....\$26.99

**YAC1425P** Aircell Sax .....\$21.99

## MICRO CORDS

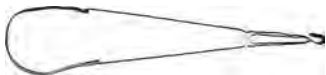

**ALTO/TENOR**

**MIC6500** Black .....\$7.70

**MIC6510** White .....\$7.70

## BOPEP STRAPS



Available in blue, red, black, green and gray.

**BOPEP6BK** W/O Neck Pad .....\$9.85

Black Only

**BOPEP7BK** W/Neck Pad .....\$13.15

**BOPEP9BK** Cushioned Pad .....\$16.45

## HOLLYWOOD WINDS SAX STRAPS



**SNSE** Ergonomic, Swivel Hook .....\$25.00

**SNSEM** Ergonomic, Metal Hook .....\$25.00

**SNSEX** Ergonomic, Swivel Hook XL .....\$25.00

**SNSEM** Ergonomic, Metal Hook XL .....\$25.00

## LM SAX STRAPS



**IAHP** Hootenany, Pink .....\$15.00

**IAHO** Hootenany, Orange .....\$15.00

**IAHB** Hootenany, Blue .....\$15.00

**IAHL** Hootenany, Lavender .....\$15.00

**IA3N** Black Poly w/Vinyl Pad .....\$6.20

**IA3** 1" Black Poly .....\$3.00

## FT. BRYAN STRAPS



Woven Fabric Straps, available in black.

**ATS16 BK** .....\$3.50

**ATS17PAD** Black, Padded .....\$10.10

**ATS18BK** W/Leather Pad .....\$7.40

**ATS19BK** W/Neo Pad .....\$14.75

## SOUSAPHONE PADS



**WHITE LEATHER**

**6547** Shoulder\* .....\$43.95

**6548** Bottom\* .....\$58.20

**3544** Shoulder .....\$83.15

**3545** Set .....\$157.80

**6549** Econo, Shoulder\* .....\$15.00

**B3344** Shoulder .....\$25.40

**2810P** Shoulder .....\$70.85

\* Available in Black

**SOUSP** Shoulder Pad Neotech .....\$43.95

**SOUCP** Cradle Pad Neotech .....\$36.95

Note: Not leather

## RICO STRAPS

**SJA01** Soprano/Alto Sax Jazz Wave .....\$15.75

**SLA10** Tenor/Bari Sax Jazz Wave .....\$15.75

**SJA02** Soprano/Alto Sax Industrial .....\$15.75

**SLA09** Tenor/Bari Sax Industrial .....\$15.75

**SJA03** Soprano/Alto Sax Jazz Stripe 2 .....\$15.75

**SLA08** Tenor/Bari Sax Jazz Stripe 2 .....\$15.75

**SJA04** Soprano/Alto Sax Jazz Stripe .....\$15.75

**SLA07** Tenor/Bari Sax Jazz Stripe .....\$15.75

**SJA05** Soprano/Alto Sax Gray Scales .....\$15.75

**SLA06** Tenor/Bari Sax Gray Scales .....\$15.75

**SJA11** Soprano/Alto Sax Black .....\$15.75

**SLA11** Tenor/Bari Sax Black .....\$15.75

**SJA14** Soprano/Alto Sax **Black Leather** .....\$38.00

**SLA14** Tenor/Bari Sax **Black Leather** .....\$38.00

### SWIVEL HOOKS

**SJA13** Soprano/Alto Sax, Black .....\$18.00

**SLA13** Tenor/Bari Sax, Black .....\$18.00

### PADDED

**SJA12** Soprano/Alto Sax padded sax strap ...\$36.00

**SLA12** Tenor/Bari Sax padded sax strap .....\$36.00

### BLUE NOTE SAX STRAPS

**SLA15** Tenor/Bari Sax True Blue .....\$36.75

**SLA17** Tenor/Bari Sax Black Fire .....\$36.75

**SLA16** Tenor/Bari Sax Afro-Cuban .....\$36.75

### RICO PADDED SAX STRAP WITH PLASTIC SNAP HOOK

The padded strap is made from plush memory foam, providing extra comfort on your neck.

**SJA18** Soprano/Alto Sax .....\$38.00

**SLA18** Tenor/Bari Sax .....\$38.00



## RICO CLARINET STRAP

Designed to fit most Bb and A clarinets, the Rico Clarinet strap features easy-slide adjuster, and a sturdy leather tab to connect strap to the thumb rest.

**CCA01** With Thumb Rest .....\$27.25

## AMERICAN MUSIC PRODUCTS



1" wide, deluxe, padded strap with metal snap.

**MTLBK** Black .....\$19.95

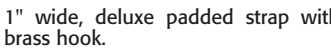

1" wide, deluxe padded strap with brass hook.

**BHKBK** Black .....\$19.95

**DXSMETSBK** Swivel .....\$19.95



1" wide, without pad.

**STBK** Black .....\$10.95



1" wide, deluxe, padded strap with plastic snap. Available in: (R) red, (PB) pacific blue, (SI) silver, (BU) burgundy, and (BK) black, (GO) Gold, (PU) Purple, & (CA) Camouflage.

**SNP** .....\$19.95



1" wide bass clarinet strap with 2-1/2" pad.

**BCLAR** Black .....\$24.95



2" wide, deluxe, padded sax sling.

**SXSLG** Black .....\$24.95

Makes it possible to stand and play tuba in complete comfort.

**TUBA** .....\$24.95



Fully adjustable sax harness strap, adjusts to assure a custom and comfortable fit.

**HAR** Blue Note .....\$24.95

# VALENTINO REPAIR PRODUCTS

## TRAVEL REPAIR KIT



Over 400 pieces: pads for flute, clarinet and saxophone, brass instrument water key cork replacements, saxophone neck cork replacements, and clarinet joint cork replacements.

**TTRK** .....\$407.00

## STANDARD REPAIR KIT



Over 250 pieces of the most often used pads for flute, clarinet and saxophone; and brass instrument water keys.

**VSRK** .....\$266.00  
**MFSK** Flute.....208.40

## EMERGENCY KIT



Designed to fit inside most clarinet cases. It contains assorted pads, a register key cork pad, a thumb rest cushion, tenon joint corks, and tools.

**ECKC** .....\$56.00

## STUCK SLIDE KIT



Gripping cloth, slide hammer, slide paddle, and all the equipment, and tools you'll need to free stuck tuning slides.

**VSSRK** .....\$198.50  
**700051** Mpc Dent Tool.....42.75

## SAMPLER KIT



Assorted pads and key corks for flute, clarinet and saxophone; and water key cork replacement pads for brass instruments.

**VPSK** .....\$182.50

## DELUXE REPAIR KIT



The top layer is a brass repair kit containing stuck slide tools, water key corks replacements, and other valuable products. The lower section is complete with clarinet, saxophone, and flute pads, cork grease, key and tenon corks, and all the tools necessary to keep your woodwind students playing every day.

**VDRK** .....\$602.00

## ACCESSORIES

<b>700321</b>	Clarinet Joint Cork Complete Set (synthetic - 5 pk) .....	<b>\$19.50</b>
<b>CICB</b>	Clarinet Joint Cork Bundy (Synthetic - 4 pk) .....	<b>15.00</b>
<b>CICC</b>	Clarinet Joint Cork Center Joints (Synthetic - 4 pk) .....	<b>15.00</b>
<b>CJCM</b>	Clarinet Mouthpiece Cork Replacements (Synthetic - 4 pk) .....	<b>15.00</b>
<b>FD#C</b>	Flute D# Cork .....	<b>3.30</b>
<b>700342</b>	Sax Neck Cork for Alto, Tenor and Baritone (Synthetic - 4 pk) .....	<b>24.00</b>
<b>700655</b>	8.5mm w/Keycorks	<b>700663</b> 10.5mm w/Keycorks
<b>700657</b>	9.0mm w/Keycorks	<b>700665</b> 11.0mm w/Keycorks
<b>700658</b>	9.5mm w/Keycorks	<b>700667</b> 11.5mm w/Keycorks
<b>700661</b>	10.0mm w/Keycorks	<b>700669</b> 12.0mm w/Keycorks
	<b>\$10.45/dz.</b>	<b>\$10.45/dz.</b>
<b>CTRC</b>	Thumb Cushion .....	<b>\$8.30/dz.</b>
<b>KCFC</b>	Key Clamp .....	<b>7.00</b>
<b>700060</b>	Spring Tool .....	<b>14.00</b>
<b>700051</b>	Mpc Dent Tool .....	<b>42.75</b>
<b>VLVSA</b>	Sax Key Bumper .....	<b>26.80/48</b>
<b>700362</b>	1/32 Ky/Ck Switch .....	<b>6.00</b>
<b>VJMP</b>	Mpc Puller .....	<b>98.45</b>
<b>700551</b>	Valve Instr Washer .....	<b>21.60/24</b>
<b>113026</b>	Pad Juice, 4 oz. ....	<b>25.10</b>

## NEOTECH WORK MATS



Soft rubberized surface grips to keep small parts in place and it resists the effects of cleaning chemicals and oils.

<b>WM1624</b>	16" x 24" .....	<b>\$10.80</b>
<b>WM2032</b>	20" x 32" .....	<b>13.80</b>
<b>WM2442</b>	24" x 42" .....	<b>18.35</b>
<b>TWBK</b>	Seat Wedge, Black.....	<b>10.85</b>

## DR. DAN'S HORN SOAP

**OSDOC1** .....\$8.95

## LEAK LIGHT



**236077** Rope Style.....\$33.75B

## PIANO TUNING HAMMERS



**K&M**  
**KM166** Star Head .....
 **\$34.99** || **KM1661** | Square Head ..... | **39.99** |

**TROPHY**  
**8024** Star Head .....
 **\$28.00** || **8025** | Square Head ..... | **28.00** |
| **8026** | Star Head only ..... | **14.05** |

## HOLLYWOOD WINDS HORN BLOWERS



The Horn Blower takes just seconds to place in position and to turn on. It is compact and easily fits in most instrument cases.

<b>HBTRPD</b>	Trumpet w/Timer .....	<b>\$89.00B</b>
<b>HBTRPB</b>	Trumpet .....	<b>49.00B</b>
<b>HBASXD</b>	Alto Sax w/Timer.....	<b>85.00B</b>
<b>HBASXB</b>	Alto Sax .....	<b>45.00B</b>
<b>HBTSXD</b>	Tenor Sax w/ Timer .....	<b>85.00B</b>
<b>HBTSXB</b>	Tenor Sax.....	<b>45.00B</b>

## MUSEDO METRONOME/TUNERS



**CHROMATIC TUNER/METRONOME**  
Metronome w/Meters and Beat Subdivision, Includes External Clip On Pickup, Scale Tone Generator w/Volume  
**MT30** .....\$21.65



**SCALE TONE GENERATOR W/VOLUME**  
40-208 bpm, Metronome w/Meters and Beat Subdivision, 9 Options of Beat Tones.  
**M11** .....\$20.25

# METRONOMES

## TAKTELL



Housed in colored plastic casing. Only 5 1/2" high, yet equal in performance to full size models.

<b>W831</b>	Dark Brown .....	<b>\$58.00B</b>
<b>W832</b>	Ivory .....	<b>58.00B</b>
<b>W834</b>	Ruby Red.....	<b>58.00B</b>
<b>W835</b>	Lite Brown .....	<b>58.00B</b>
<b>W836</b>	Black.....	<b>58.00B</b>
<b>W830</b>	<b>Specify color*</b> .....	<b>61.50B</b>
<b>W830U7</b>	Key .....	<b>1.50</b>
<b>W830U4</b>	Weight.....	<b>1.65</b>

\*231 (O), 361 (PI), 371 (LILAC), 391 (TURQ), 421 (G), 471 (VIOLET)

## TAKTELL SUPER MINI



Small enough to fit into pocket! High-impact plastic housing. Precision built with same accuracy and durability as larger Metronomes. 4" high, 1 1/8" wide, 1 7/8" deep.

<b>W882</b>	Ivory .....	<b>\$50.85B</b>
<b>W884</b>	Ruby Red.....	<b>50.85B</b>
<b>W886</b>	Black.....	<b>50.85B</b>
<b>W880</b>	Walnut Wood Case .....	<b>115.00B</b>
<b>W880U7</b>	Key .....	<b>1.50</b>
<b>W880U4</b>	Weights .....	<b>1.65</b>

## TAKTELL PICCOLINO



Very small metronome yet loud enough to be heard. High impact plastic housing.

<b>W896</b>	Black Piccolino .....	<b>\$60.25B</b>
<b>W894</b>	Red Piccolino.....	<b>60.25B</b>

## TAKTELL CLASSIC



Plastic housing. Extremely accurate.

<b>W829161</b>	Black/Silver .....	<b>\$68.55B</b>
<b>W829561</b>	Black/Gold .....	<b>79.55B</b>

## WITTNER



Housed in fine wood grain cabinet. Precision built and extremely accurate.

<b>W806M</b>	Black .....	<b>\$149.65B</b>
<b>W806BK</b>	Black Ultra High Gloss .....	<b>170.00B</b>
<b>W803M</b>	Walnut .....	<b>149.65B</b>
<b>W801M</b>	Mahogany.....	<b>149.65B</b>
<b>W811M</b>	Mahogany W/Bell.....	<b>167.15B</b>
<b>W813M</b>	Walnut W/Bell .....	<b>167.15B</b>
<b>W816M</b>	Black W/Bell.....	<b>167.15B</b>
<b>W800U7</b>	Key .....	<b>1.50</b>
<b>W800U4</b>	Weight .....	<b>1.65</b>

Pyramid shape in plastic housing

<b>W804K</b>	Walnut, Clear Cover.....	<b>\$68.65B</b>
<b>W806K</b>	Black, Clear Cover .....	<b>68.65B</b>
<b>W845111</b>	Mahogany, Wood Grain .....	<b>74.25B</b>
<b>W845131</b>	Walnut, Wood Grain.....	<b>74.25B</b>
<b>W845161</b>	Black, Wood Grain .....	<b>74.25B</b>

Animal shaped Metronome. Precision built and as accurate as traditional style Metronomes.

<b>W839011</b>	Penguin.....	<b>\$103.95B</b>
<b>W839021</b>	Cat.....	<b>103.95B</b>
<b>W839031</b>	Owl .....	<b>103.95B</b>
<b>W839KEY</b>	Key .....	<b>1.50</b>



## QUARTZ



KMA1

Quartz Metronomes featuring virtually perfect temposettings and a 440 tone for ease of tuning instruments.

<b>KMA1</b>	Korg (B) Blue or (R) Red .....	<b>\$21.99</b>
<b>KMCM1</b>	Micro Metronome Clip Blue or Red .....	<b>14.99B</b>
<b>MT50</b>	Wittner .....	<b>35.99B</b>
<b>MT60</b>	Wittner with LEDs .....	<b>53.99B</b>
<b>MT70</b>	Digital, LED Pendulum .....	<b>64.99B</b>



KORG

## METRONOME AND THERMOMETER & HUMIDITY DETECTOR

Thermometer, hygrometer, metronome, and clock monitors the instrument. LED beat indicator. 9 Time signatures; 5 patterns: (duplets, triplets, quadruplets). Measures temperature and humidity. Beat-counting LCD screen. Pendulum steps, full steps, or tap tempo.

<b>HB1</b>	.....	<b>\$59.99</b>
------------	-------	----------------

(W) White, (BK) Black

## QWIK TIME



QT5

Accurate, yet inexpensive.

<b>QT5</b>	Mini.....	<b>\$13.95B</b>
<b>QT3</b>	Quartz .....	<b>21.95B</b>
<b>QT7</b>	Accent Beat .....	<b>24.95B</b>

## POCKET



Credit card size, audible/visible beat or visual only. Variable speeds from 35-250 beats.

<b>MT40</b>	Wittner.....	<b>\$30.99B</b>
-------------	--------------	-----------------

## SEIKO



SDM51

### CLIP-STYLE METRONOME

Digital metronome with clock function, easy volume control, high contrast LCD, available in Black (BK) and Silver (SI)

<b>SDM51</b>	.....	<b>\$34.99B</b>
--------------	-------	-----------------

### FULL FUNCTION POCKET-SIZED DIGITAL METRONOME

Easy operation, clear sound, sound generation, built in stand, high contrast LCD, available in Black (BK) and Silver (SI)

<b>SDM71</b>	.....	<b>\$43.65</b>
--------------	-------	----------------

## YAMAHA



### YAMAHA

<b>YAMQTI</b>	Quartz .....	<b>\$60.00*</b>
<b>YME55BK</b>	Clip-on Black .....	<b>37.99B</b>

## WITTNER



Electronic Metronome featuring audio/visual beat and infinitely variable tempo selection

<b>W877</b>	.....	<b>\$60.00B</b>
-------------	-------	-----------------

(\* = CALL FOR DEALER NET)



# METRONOMES MATRIX



### QUARTZ

Tempo from 40 to 208 beats per minute and an A440Hz (standard "A") freq. tone generator to assist in tuning just about any instrument.

MR500 .....\$30.99B  
MR550 .....42.99B



### QUARTZ

8 L.E.D. for pendulum simulation. Fully adjustable tempo. Earphone out. Compact Size.

MR800 .....\$33.99B



### QUARTZ

This is the one. Don't be fooled by imitations! Includes earphone

MR600 .....\$55.99

## SEIKO

### Full Function Pocket-Sized Digital Metronome

- Easy operation
- Clear sound
- Sound generation
- Built in stand
- High contrast LCD
- Available in Black (BK) and Silver (SI)

SDM71 .....\$43.65



### Clip-Style Metronome

- Digital metronome with clock function
- Easy volume control
- High contrast LCD
- Available in Black (BK) and Silver (SI)

SDM51 .....\$34.99B



### Multi-Function Quartz Metronome with "Tap In" Function

- Available in Black (BK)

SDM100 .....\$61.00

### Quartz Metronome with Easy Operation Tempo Dial

- Tempo range: 39 steps
- Tone generation: A4 (440Hz)
- Available in Black

SSQ50V .....\$42.95

SSQ70 2 Selectable Tempo Sounds .....102.85



## PLANET WAVES METRONOME/TUNER

The full featured Metronome includes a loud woodblock tone while tempo, beats per measure and time division variations make the most basic to complicated rhythms possible.

PWMT01 .....\$25.50

The full featured metronome includes loud woodblock tone, tempo, beats per measure, and time division variations making the most basic to complicated rhythms possible. Precision chromatic tuner, pitch pipe and easy-to-navigate menu.

PWMT02.....\$33.65

## PETERSON BODY BEAT



The BodyBeat Sync features a complex metronome engine capable of producing endless combinations of rhythmic patterns. Meter or Time Signature parameters are independently adjustable allowing 1-12 beats per measure over a beat value of 2, 4, 8 or 16.

BBS1 .....\$179.00B

## CHERUB



### Intelligent Metronome

- Tempo Range: 40-208 bpm ( $\pm \leq 5\%$ )
- Beats: 0, 1, 2, 3, 4, 5(2\_3), 5(3 x 2), 6
- Tempos forte beat, piano beat and pre-beat
- Clicking and bell sound (Mute available)
- Tone generation C, D, E, F, G, A, B, bD, bE, bG, bA
- Earphone Jack (2.5 mm)
- Power Supply 3V 1.5Vx2 (AAA Size)

WSM001ABK .....\$21.95



### Tuner-Metronome Combo

The auto-chromatic tuner has an ultra-wide range to accommodate most wind and string instruments. Features selectable key (for tuning a variety of instruments), chromatic tuner, calibration, full-function metronome w/ear bud.

- Tuning range: A0(27.5Hz)-A3(1760Hz)
- A4:435-445Hz • C, F, B, E

WMT555C.....\$27.95



### Mechanical Metronome

Select between 40 and 208 beats per minute, 4 selectable accents, or no accent at all. A loud click and crystal clearbell help you keep time. Available in Gloss Black (B).

WSM330B .....\$51.95

# GEAR & ACCESSORIES

## SHIRTS

SIZE PART# MSRP

### Classic T, Black

S	T3001	\$19.95*
M	T3002	\$19.95*
L	T3003	\$19.95*
XL	T3004	\$19.95*
XXL	T3005	\$19.95*
XXXL	T3006	\$19.95

### Classic T, Chocolate

S	T4411	\$19.95
M	T4412	\$19.95
L	T4413	\$19.95
XL	T4414	\$19.95
XXL	T4415	\$19.95
XXXL	T4416	\$19.95

### Kids Black Classic T

M	T4462	\$14.95
L	T4464	\$14.95
XL	T4467	\$14.95

### Military Green T

S	T5631	\$19.95*
M	T5632	\$19.95*
L	T5633	\$19.95*
XL	T5634	\$19.95*
XXL	T5635	\$19.95*
XXXL	T5636	\$19.95*

### Heathered Blue T

M	T6742	\$19.95
L	T6743	\$19.95
XL	T6744	\$19.95
XXL	T6745	\$19.95

### Biker T

S	T6801	\$24.95
M	T6802	\$24.95
L	T6803	\$24.95
XL	T6804	\$24.95
XXL	T6805	\$24.95

### Camo Logo

S	T4551	\$19.95
M	T4552	\$19.95
L	T4553	\$19.95
XL	T4554	\$19.95

## SHIRTS (Cont.)

SIZE PART# MSRP

### Monkey T

S	T6811	\$19.95
M	T6812	\$19.95
L	T6813	\$19.95
XL	T6814	\$19.95

### Classic Black Tank Top

S	T4521	\$19.95
M	T4522	\$19.95
L	T4523	\$19.95
XL	T4524	\$19.95

### Skull T

M	T5742	\$19.95
L	T5743	\$19.95
XL	T5744	\$19.95
XXL	T5745	\$19.95
XXXL	T5746	\$19.95

### Women's Trademark T

M	T6102	\$19.95
L	T6103	\$19.95
XL	T6104	\$19.95

### Women's Bling T, Black

S	T7131	\$24.95
M	T7132	\$24.95
L	T7133	\$24.95
XL	T7134	\$24.95

### Women's Bling T, Linen

M	T7142	\$24.95
L	T7143	\$24.95
XL	T7144	\$24.95

### Long Sleeve T, Black

M	T4122	\$24.95
L	T4123	\$24.95
XL	T4124	\$24.95

### Zildjian Polo

S	T6351	\$24.95
M	T6352	\$24.95
L	T6353	\$24.95
XL	T6354	\$24.95

## HATS

SIZE PART# MSRP

### Black on Black Flexfit® Cap

T3219 \$19.95\*

### Black Baseball Cap w/Gold Logo

T3200 \$12.95\*

### Ranger Cap

T3205 \$14.95\*

### Classic Patch Beanie, Black

T7160 \$19.95

### Classic Patch Beanie, Grey

T7161 \$19.95

### Five Panel Hat, Black

T4540 \$19.95

### Five Panel Hat, Camo

T4541 \$19.95

### Classic Flat Bill Hat

T4542 \$19.95

## ATHLETICS

SIZE PART# MSRP

### Zildjian Stamp Thermal Shirt

M	T6752	\$24.95
L	T6753	\$24.95
XL	T6754	\$24.95
XXL	T6755	\$24.95

### Classic Zildjian Sweatshirt

S	T7101	\$34.95
M	T7102	\$34.95
L	T7103	\$34.95
XL	T7104	\$34.95

### Classic Zildjian Sweatpants

S	T7111	\$29.95
M	T7112	\$29.95
L	T7113	\$29.95
XL	T7114	\$29.95

### Long Sleeve Lightweight Hoodie

S	T7121	\$29.95
M	T7122	\$29.95
L	T7123	\$29.95
XL	T7124	\$29.95

### Basketball Jersey

M	T4532	\$59.95
L	T4533	\$59.95
XL	T4534	\$59.95
XXL	T4535	\$59.95
XXL	T4536	\$59.95

Best Sellers = \*

New/Re-released Models = 

New price effective June 1st = \*\*

# MERCHANDISE BAGS

## POLY BAGS



Ideal for each dealer "check out" location in store. Weighs 50% less than paper\*, waterproof, four most popular sizes in addition to T-Shirt size, recyclable.

<b>6595</b>	6 1/2" x 9 1/2".....	<b>\$117.05 per 1000</b>
<b>8511</b>	8 1/2" x 11".....	<b>170.05 per 1000</b>
<b>1215</b>	12" x 15".....	<b>221.60 per 1000</b>
<b>1515</b>	15" x 15".....	<b>258.10 per 1000</b>
<b>12721</b>	12" x 7" x 21" (T-S).....	<b>306.70 per 1000</b>
<b>BAGS1</b>	Stand for 12721.....	<b>116.25 ea.</b>



## PAPER BAGS

For Records, Sheet Music, or Accessories  
**WHITE BAGS**  
Brown Pattern on White Paper

<b>8902</b>	.....	<b>\$ 30.80 per 500</b>
Accessory Bag, 6" x 9" for small parts		
<b>9911</b>	.....	<b>96.05 per 500</b>
General Bag, 8 1/2" x 11"		
<b>8906</b>	.....	<b>62.60 per 500</b>
Standard Bag, 12" x 15" for sheet music, books		
<b>9915</b>	.....	<b>208.00 per 500</b>
Oversize Bag, 15" x 15"		
<b>9901</b>	.....	<b>144.00 per 500</b>
Drum Stick Bag		
<b>9909</b>	.....	<b>50.45 per 500</b>
Accessory Bag, 3" x 5" for picks and parts		
<b>EV185</b>	.....	<b>5.75 per 100</b>
2" x 3" zip close plastic bag		
<b>EV186</b>	.....	<b>9.25 per 100</b>
3" x 4" zip close plastic bag		

# TELLENO AWARD PINS



**AP7**  
Violin



**AP4**  
Guitar



**AP39**  
Baritone



**AP3**  
Saxophone



**AP5**  
Trumpet



**AP43**  
Trombone



**AP40**  
Sousaphone



**AP38**  
French Horn



**AP8B**  
Clef



**AP15**  
Drum



**AP35**  
Perfect Attendance



**AP1225**  
Bassoon



**AP12B**  
Clarinet



**AP42G**  
Organ



**AP6W White**  
**AP6G Gold**  
**AP6B Black**



**AP1217**  
Oboe



**AP41S**  
Flute



**AP36**  
Honor



**AP29**  
Band



**AP28**  
Music



**AP30**  
Orchestra



**AP27**  
Choir



**AP32**  
Chorus



**AP6H**  
Piano Honor

All Telleno Award Pins are gold plated, individually boxed, enamel filled  
**\$4.80 Each**

### BLUE ENAMEL



**7021B BRONZE**  
**7021S SILVER**  
**7021G GOLD**



**7065 BRONZE**  
**7065S SILVER**  
**7065G GOLD**



RED, WHITE & BLUE  
GROS GRAIN SILK RIBBON



**9025B BRONZE**  
**9025S SILVER**  
**9025G GOLD**



**6235B BRONZE**  
**6235 GOLD**

**MEDALS WITH RIBBONS - \$7.30**

**Add Suffix "R" To Model #**  
**IE: 7021BR • Medal with Ribbon**

**MEDALS WITHOUT RIBBONS - \$6.40**

# HARMONY JEWELRY



## PINS

FPP547	Clarinet.....	\$21.90
FPP568	Oboe.....	15.00
FPP537G	Drumsticks.....	15.00
FPP542G	Tenor Sax.....	15.00
FPP545G	Gold Trumpet.....	15.00
FPP545S	Silver Trumpet.....	15.00
FPP546S	Flute.....	15.00
FPP549G	Drumset.....	15.00
FPP550G	Gold T-Bone.....	15.00
FPP558G	French Horn.....	15.00
FPP566G	Alto Sax.....	18.00
FPP573G	Tuba.....	15.00
FPP577G	Bari Sax.....	15.00
FPP598M	Bassoon.....	22.05
FPP605G	Gold Euphon.....	27.30
FPP543GM	Violin.....	15.00
FPP596BZ	Cello.....	27.30
FPP597BZ	String Bass.....	27.30
FPP517GBK	Blk Les Paul.....	18.90
FPP520GBK	Black Strat.....	18.90
FPP521GBK	Black Tele.....	15.00
FPP524GWG	Martin Guitar.....	18.90
FPP529GBK	Steinway.....	18.90
FPP531GGD	G Clef.....	15.00
FPP532GGD	1/8 Note.....	15.00
FPP578SBK	Snare Drum.....	15.00

## NECKLACES

FPN547	Clarinet.....	\$23.10
FPN545G	Gold Trumpet.....	23.10
FPN545S	Silver Trumpet.....	23.10
FPN546S	Flute.....	23.10
FPN566G	Alto Sax.....	23.10
FPN543GM	Gold Violin.....	23.10
FPGCHAIN	Gold Chain.....	9.00

## EARRINGS

FPE547	Clarinet.....	\$23.10 PR
FPE546S	Flute.....	23.10 PR

# AIM MUSIC GIFTS



## MAGNETS .....\$3.00

AIM1000	Piano Keys
1001	Hands on Piano Keys
1002	Floating Keyboard
1004	Grand Piano with Notes
1007	G-clef
1009	8th Note
1010	16th Note
1011	Music Staff
1014	"I Love Music"
1021	Bach
1027	Violin
1029	Flute
1030	Clarinet
1031	aSaxophone
1032	Trumpet
1033	Trombone
1038	Acoustic Guitar
1048	7 pc. Drum Set
1049	5 pc. Drum Set

## STICKY PADS .....\$2.30B

AIM4600	Grand Piano
4601	Upright Piano
4602	8th Note
4603	Quick Note

## WRITING TABLETS .....\$3.35B

AIM 4401	Sheet Music
4402	Violin
4403	"Key Notes"
4405	"Love Notes"
4407	"Shopping Liszt"
4412	Trumpet

## HOUSEHOLD ITEMS

(SHEET MUSIC DESIGN)  
AIM 8606 Coasters..... .95

## TOTEBAGS .....\$15.55

AIM2300	Grand Piano white
2302	Grand Piano blue
2306	"Entertainer" blue
2308	G-Clef white
2309	G-Clef red
2310	G-Clef blue
2313	Violin red
2314	Violin blue
2317	Band red
2325	Instrument
2327	Grand Piano
2328	Entertainer
2329	G-Clef
2330	Violin
2331	Keyboard

## SHEET MUSIC TOTE

AIM2351	.....	\$15.55
---------	-------	---------

## BUTTONS .....\$1.70

AIM350	Luv Music
--------	-----------

## SUSPENDERS .....\$19.15

AIM5900	Keyboard white
---------	----------------

## LICENSE PLATES .....\$6.40B

AIM 8309	Drums
8312	I Love Country Music

## COOKIE CUTTERS .....\$1.70B

AIM8701	1/8 Note
AIM8705	Guitar

# HALBE STATUETTES



Height 4 1/2", Base 2". Made of the finest vinyl plastic .....\$4.25B

BACH	HANDEL	RACHMANINOFF
BEETHOVEN	HAYDN	SCHUBERT
BRAHMS	LISZT	SCHUMANN
CHOPIN	MACDOWELL	STRAUSS, J.
DEBUSSY	MENDELSSOHN	TSCHAIKOWSKY
GRIEG	MOZART	WAGNER

Height 5" TO 5 1/2" .....\$5.00B

BACH	LISZT	SCHUMANN
BEETHOVEN	MENDELSSOHN	TSCHAIKOWSKY
BRAHMS	MOZART	VERDI
CHOPIN	SCHUBERT	WAGNER

# AIM MUSIC GIFTS



## MINI PINS

.....\$6.15

## KEYCHAINS

.....\$8.35

### GUITARS

- AIM1A L.P. Custom (Blk)
- 1B L.P. Custom (Wh)
- 1C L.P. Custom (Gold)
- 1D L.P. Std. (Sunburst)
- 11A S.G. Doubleneck (Wh)
- 11B S.G. Doubleneck (Red)
- 13 Martin D-45
- 14A Classical Guitar (Cedar)
- 14B Classical Guitar (Spruce)
- 15 Ovation Legend
- 18 B.C. Rich Doubleneck
- 23 335 (Red)
- 25 GRETSCH
- 27 Ibanez Iceman
- 8898 Display Card .....\$5.50B



### PAGE CLIP

- AIM9400 The Solution .....\$5.95

### DOOR MATS

.....\$39.95B

- AIM5500 Music Staff
- 5501 Keyboard

### BENCILS

.....\$3.15B

- (G clef formed pencils)
- AIM1600 Black
- 1601 Red
- 1602 Blue
- 1603 Yellow
- 1604 Hot Pink
- 1605 Purple
- 1606 Green

### AMPS

- AIM37 Marshall Stack

### MIKES & RECORDING

- AIM40 Shure Microphone

### KEYBOARDS

- AIM45A Grand Piano (Blk)
- 45B Grand Piano (Wh)
- 45C Grand Piano (Rosewood)
- 45D Upright Piano (Blk)
- 51A Accordion (Blk)

### PERCUSSION

- AIM52B 5 pc. Drum Set (Red)
- 53A 7 pc. Drum Set (Blk)
- 53B 7 pc. Drum Set (Wh)
- 53C 7 pc. Drum Set (Red)
- 54A Double Bass Drum Set (Blk)
- 54C Double Bass Drum Set (Red)
- 55 Snare Drum
- 56 Drum Sticks

### BAND & ORCHESTRA

- AIM61 Flute
- 62 Trumpet
- 63 Trombone
- 64 Clarinet
- 65 Oboe
- 67A Alto Saxophone
- 67B Tenor Saxophone
- 68 Baritone Saxophone
- 69 French Horn
- 70 Sousaphone
- 71 Upright Tuba

### GOT MUSIC?

#### HATS

- AIM6419B Blue .....\$18.85
- 6419PI Pink .....18.85

### BAND & ORCHESTRA

- AIM66 Recorder
- 73 F-5 Mandolin
- 74A Violin
- 74B Viola
- 75 Cello
- 76 Bass Violin
- 77 Dobro D-60
- 78 Banjo
- 79 Pedal Steel Guitar
- 80 Harmonica 1896 M.B.

### MUSICAL MOTIFS

- AIM81 G-Clef
- 81D Bass Clef
- 82 Eighth Note
- 83 16th Note
- 88 Heart w/8th Note (Ass't colors)
- 94 Floating Keyboard

### PIN GIFT BOX

- AIM8807 .....\$1.00

### I.D. TAGS

.....\$3.00

For instrument cases & luggage

- AIM1700 Keyboard
- 1701 G-clef
- 1702 Staff
- 1704 "Music Is My Bag"
- 1705 Violin
- 1706 Flute
- 1707 Clarinet
- 1708 Sax
- 1709 Trumpet
- 1710 Trombone
- 1711 French Horn
- 1712 Acoustic Guitar
- 1718 7 pc. Drum Set
- 1723 Tuba
- 1724 Band
- 1725 Orchestra
- 1730 Bassoon
- 1731 Oboe

### SCARVES

.....\$28.10B

- AIM6600 Keyboard winter

### AWARD CERTIFICATES

.....\$4.00

- Gold Paper
- AIM13307 Excellence band
- 13309 Excellence piano



# PLAYERS PRIVATE LABEL PROGRAM

## PRIVATE LABEL PLAYERS MAINTENANCE KITS

- Min. order 36 kits any mix. *One time set up charge \$45.00.*
- 144 kits or more any mix. *No set up charge.*
- Record your store message, promotion, instrument lines, lessons, repairs, rentals, etc. on side II of instruction cassette in each kit. Send your pre-recorded message (up to 7 minutes long). *No set up charge.*
- Regular kit prices apply.

## BULK

### PRIVATE LABEL BRUSHES 100% NYLON HANDLES

<b>RBBR2BPL</b> Brass	36 .....	<b>\$4.10 ea.</b>
<b>RBWWB1PL</b> Woodwind	144 .....	<b>4.10 ea.</b>
<b>RBTR3BPL</b> Valve	250 .....	<b>4.10 ea.</b>
	500+ .....	<b>4.10 ea.</b>

- One time set up charge of \$45.00 net and artwork up to 2 lines in block letters. Special artwork estimate upon request.

## PRIVATE LABEL POLISHING CLOTHS (PLAIN AND TREATED) PREMIUM DOUBLE NAPPED COTTON FLANNEL

QUANTITIES	36	72	144	250	500	1000
<b>S M A L L</b> BA-PC-SBPL PLAIN 8X11"	\$4.10 <input type="checkbox"/>	<input type="checkbox"/>	<input type="checkbox"/>	<input type="checkbox"/>	<input type="checkbox"/>	<input type="checkbox"/>
BA-LQ-SBPL LACQUER 8X11"	<input type="checkbox"/>	<input type="checkbox"/>	<input type="checkbox"/>	<input type="checkbox"/>	<input type="checkbox"/>	<input type="checkbox"/>
<b>L A R G E</b> BA-SL-SBPL SILVER-TREATED 7X8"	\$4.10 <input type="checkbox"/>	<input type="checkbox"/>	<input type="checkbox"/>	<input type="checkbox"/>	<input type="checkbox"/>	<input type="checkbox"/>
BA-PC-LBPL PLAIN 12X14"	\$5.50 <input type="checkbox"/>	<input type="checkbox"/>	<input type="checkbox"/>	<input type="checkbox"/>	<input type="checkbox"/>	<input type="checkbox"/>
BA-SL-LBPL SILVER 7X16"	\$5.50 <input type="checkbox"/>	<input type="checkbox"/>	<input type="checkbox"/>	<input type="checkbox"/>	<input type="checkbox"/>	<input type="checkbox"/>
BA-SP-PL 1-8X8" PLAIN 1-7X8" SILVER 2 IN 1 CLOTH/SILVER & PLAIN	\$2.41 <input type="checkbox"/>	<input type="checkbox"/>	<input type="checkbox"/>	<input type="checkbox"/>	<input type="checkbox"/>	<input type="checkbox"/>

Mix total quantity of plain, lacquer, silver cloths for maximum discount.

All cloths bulk unpackaged. Add 10¢ for zip lock bag.

- One time set up charge of \$45.00 with your artwork. Special artwork estimate upon request.

## PRIVATE LABEL CASE ID TAGS

100 PIECES @ \$2.60 EACH

TAG-PL

TAGD-PL

"DELUXE" VINYL RIGID TAG W/INSERT

100 PIECES @ \$3.30 EACH

CHOICE OF TAG COLORS: WHITE  BLACK   
CHOICE OF INK: White  Black  Red  Gold

STOCK TAG COLORS: WHITE  BLACK

- One time art set-up charge of \$45.00 for up to 4 lines of block letters w/camera ready artwork. Special artwork estimate upon request.

ALLOW UP TO 4 WEEKS FOR SPECIAL ORDERED COLORS:

Red  Orange  Yellow  Lt. Blue  Drk. Blue  Green  
 Lt. Brown  Drk. Brown

## PRIVATE LABEL PREMIUM OILS

QTY.	Combination Valve/Slide/Key Oil Odorless				CLEAR	MIXED COLORS
	VO-S-BPL	SO-S-BPL	KEY-O-BPL	C-VSK-BPL		
36	<input type="checkbox"/>	<input type="checkbox"/>	<input type="checkbox"/>	<input type="checkbox"/>	<input type="checkbox"/>	\$3.80 <input type="checkbox"/>
72	<input type="checkbox"/>	<input type="checkbox"/>	<input type="checkbox"/>	<input type="checkbox"/>	<input type="checkbox"/>	\$3.80 <input type="checkbox"/>
144	<input type="checkbox"/>	<input type="checkbox"/>	<input type="checkbox"/>	<input type="checkbox"/>	<input type="checkbox"/>	\$3.80 <input type="checkbox"/>
250	<input type="checkbox"/>	<input type="checkbox"/>	<input type="checkbox"/>	<input type="checkbox"/>	<input type="checkbox"/>	\$3.80 <input type="checkbox"/>
500	<input type="checkbox"/>	<input type="checkbox"/>	<input type="checkbox"/>	<input type="checkbox"/>	<input type="checkbox"/>	\$3.80 <input type="checkbox"/>

- One time set-up charge of \$45.00 for each item and artwork up to 3 lines in block letters. Special artwork estimate upon request.

### 36 ONE ITEM BLUK UNPACKAGED /72 OR MORE ANY MIX

QTY.	CG-S-BPL	MPGSBPL
36	\$2.60 <input type="checkbox"/>	<input type="checkbox"/>
72	\$2.60 <input type="checkbox"/>	<input type="checkbox"/>
144	\$2.60 <input type="checkbox"/>	<input type="checkbox"/>
250	\$2.60 <input type="checkbox"/>	<input type="checkbox"/>
500	\$2.60 <input type="checkbox"/>	<input type="checkbox"/>

- One time set-up charge of \$45.00 for each item and artwork up to 2 lines in block letters. Special artwork estimate upon request. Items may not be combined to attain maximum discount.

## HOT STICKS CUSTOM LABEL HICKORY DRUMSTICKS

This line of high quality American Hickory Drumsticks has been developed for customers who want the best value in a custom labelled stick. The sticks are available in standard models and are block imprinted in red, blue, purple or black metallic foil with no set-up fee. They are packaged 12 pair in a plastic bag with a minimum order of 144 pair, with a minimum of 48 pair per model (assorted between wood and nylon). A maximum of 27 characters can be printed.

144 pair minimum quantity is required with at least 48 pair in any given model (any mix of wood or nylon).  
**The list price is \$4.50 per pair.**

Imprint Colors Choices  
(One Only)  
Black  
Red  
Purple  
Blue

Model	Wood	Nylon
HI7A		
HIROCK		
HI5A		
HI5B		
HI2B		
HI3S		X

# HOHNER CUSTOMIZED MUSICAL INSTRUMENTS

Pricing includes all die, set up and standard imprint charges, making pricing a breeze.

## Harmonica Screen Printed

100 Piece Minimum

Model #569P

\$7.99(B)

Key of C  
FOB Glen Allen, VA

10 Hole Diatonic Harmonica  
Imprint Area 2½"L x ½"H

## Harmonica Laser Engraved

100 Piece Minimum

Model #569L

\$9.90(B)

Key of C  
FOB VA or WI

10 Hole Diatonic Harmonica  
Imprint Area 2½"L x ½"H

## Mini Harmonica

250 Piece Minimum

Model 38BCSP

\$3.50(B)

FOB Glen Allen, VA

Mini Harmonicas  
Imprint Area ¼" H x ⅞" L

## Mini Harmonica Keychain

250 Piece Minimum

Model 107SP

\$4.85(B)

FOB Glen Allen, VA

Mini Harmonica with Keychain  
Imprint Area ¼" H x ⅞" L

## Translucent Harmonica

100 Piece Minimum

Model 1110SP

\$5.00(B)

Key of C  
FOB Glen Allen, VA

Translucent 10 hole Harmonica  
Imprint Area 2½"L x ½"H

Colors Available: Red, Yellow, Green, Blue, Purple and Orange

## Plastic Kazoo

500 Piece Minimum

Model #KC1

\$1.30(B)

FOB Cleveland, OH

4-3/4" Long  
Imprint Area 1-5/8" L x 1/2" H

Colors Available: Red, White, Blue, Yellow, Green, Purple and Orange.

Box Imprint available on models 569-SP, 569L and 38BCSP – \$2.60(B)

# LEVY'S GUITAR STRAP DISPLAYS



34" X 17", 16-prong, 4-sided, free-standing, guitar strap floor display. Holds 144 straps.

LEVYL1 .....\$170.19\*



7-prong, slat-wall guitar strap display. Holds 72 straps.

LEVYL2 .....\$30.20\*



6-prong, compact slat-wall guitar strap display. Holds 24 straps.

LEVYL4 .....\$79.55\*

• = CALL FOR DEALER PRICING  
FREE WITH QUANTITY PURCHASE OF LEVY'S STRAPS

# INGLES SHO ALL

## WIRE GRID GUITAR HOLDERS

Now you can easily add guitars to your wire grid displays. Two holder styles provide unlimited setups. Fits standard and slat-style grid panels. Padded yoke and black finish to match black grid panels.

- SA-110** Front Facing/Black...**\$18.00**  
**SA-111** Swivel/Black.....**16.90**



SA301

## TROMBONE HOLDER

A holder design similar to the traditional trombone stand. Adjusts to fit various sized instruments. Designed with a short stem to make it easier to remove the horn. Fits slatwall or slat-style grid.

- SA-302** .....**\$44.00**



SA303

## CLARINET/FLUTE HOLDER

Holder becomes almost visually transparent behind clarinets. Dual shaped peg fits both flutes and clarinets. Special peg covering protects instrument. Fits slatwall or slat-style grid.

- SA-304** .....**\$25.90**

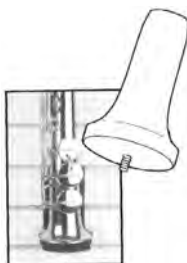

SA305

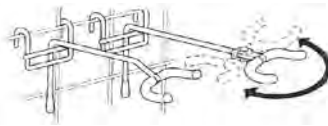

SA110

## VIOLIN/VIOLA HOLDER

Finally a holder to display stringed instruments. The yolk swivels to accommodate the different peg heights – allowing the instrument to hang straight. Fits all size instruments from a 1/8 size violin to a full size viola. Protective pads at all contact points. Holder becomes almost transparent behind the instrument. Fits slatwall or slat-style grid.

- SA-306** .....**\$21.00**  
**SA-316S** Swivel .....**25.00**

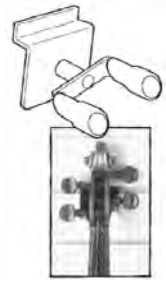

SA306

## TRUMPET HOLDER

This holder displays the instrument in the playing position. Display multiple horns, all at the same angle, to make a very dramatic display. Fits most trumpets, cornets, flugelhorns and even bugles. Protective pads at all contact points. Holder becomes almost transparent behind the horn. Fits slatwall or slat-style grid.

- SA-301** .....**\$29.00**  
**DSP511B** .....**40.99**

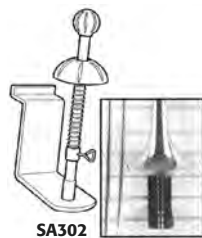

SA302

## ALTO/TENOR SAX HOLDER

Designed for ease of taking instrument in and out of holder. Supports similar to the traditional sax stand. Adjusts for alto or tenor saxophone. Fits slatwall or slat-style grid.

- SA-303** .....**\$42.00**



## SOPRANO SAX PEG

Use this special bell-shaped peg to convert the SA-304 Clarinet/Flute holder into a soprano sax holder. Wood peg mounting screw fits same threads. Peg has special covering to protect horn.

*MUST USE WITH SA-304.*

- SA-305** .....**\$31.50**  
**SA-305B** Complete.....**43.00**

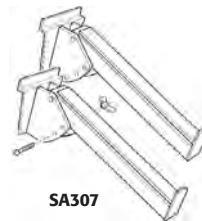

SA307

## KEYBOARD DISPLAY ARMS

Sho-All makes it easy and affordable to display any keyboard or synthesizer. The heavy-duty support arms are angle adjustable with bolt and wing nut that speeds setup and assures stability. Two arms provide adjustable width for any size keyboard. Black coated with padded contact points. Fits slatwall.

- SA-307** .....**\$79.00 pr.**

## GUITAR HOLDERS

One of the best buys in the industry. Extra heavy-duty guitar hooks with a main support rod that will not bend. Arms are padded to protect the instrument. Fits peg-board, slatwall or slat-style grid. Black or chrome finish.

- 2335L** Left Facing/Chrome.....**\$15.75**  
**2335R** Right Facing/Chrome.....**15.75**  
**2335F** Front Facing/Chrome.....**15.75**  
**2335BKL** Left Facing/Black.....**14.65**  
**2335BKR** Right Facing/Black .....**14.65**  
**2335BKF** Front Facing/Black .....**14.65**

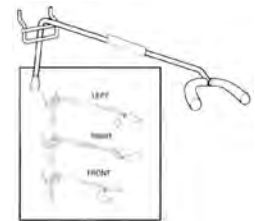

2335

## SLATWALL GUITAR HOLDERS

Features a flat plate style slatwall mount that distributes the weight more evenly in the groove. Arms are padded to protect the instrument. Fits slatwall or slat-style grid.

- 2135BKL** Left Facing/Black.....**\$16.90**  
**2135BKR** Right Facing/Black ....**16.90**  
**2135BKF** Front Facing/Black ....**16.90**



2135BK

## SWIVEL GUITAR HOLDERS

The yolk swivels to hold guitar in either left, right or front facing position. You can change your display direction without having to buy new hooks. Yoke is padded. Fits pegboard, slatwall or slat-style grid.

- 2335A** Chrome.....**\$14.65**  
**2335ABK** Black .....**13.50**



2335A

## SWIVEL SECURITY GUITAR HOLDERS

Holds guitar in either left, right or front facing position. The "Security Lock" mechanism is added to keep those electric guitars with the unique headstock shapes from slipping out of the hook. Yoke is padded. Fits pegboard, slatwall or slat-style grid.

- 2235A** Chrome .....**\$15.75**  
**2235ABK** Black .....**15.75**



2235A

## ROTATING HOOK

Yolk that rotates to adjust to uneven headstocks, and the padded arms are ribbed to keep the guitar from twisting out of the hook.

- SA-341BKL** Left Facing/Black .....**\$18.99**  
**SA-341BKR** Right Facing/Black .....**18.00**  
**SA-341BKF** Front Facing/Black .....**18.00**



SA341



# INGLES SHO ALL

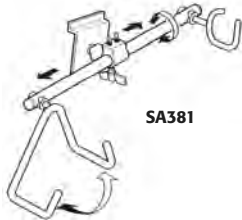

SA381

## ANGLED GUITAR HOLDER

Build exciting guitar displays. Holder adjusts to display guitar at any angle, yet guitar can easily be removed. Multiple adjustments make anything possible. Fits slatwall or slat-style grid.

- SA-381 For Electrics .....\$56.00
- SA-382 For Acoustics .....\$7.00

## FRENCH HORN/ BARITONE HOLDER

Use the main cradle section for french horn display, or add the upper support arm for display of baritone or euphonium horns. Adjusts for various size horns. Fits slatwall or slat-style grid.

- SA-312 .....\$42.00



SA312

## HEAVY SCANNER HOOK FOR CABLES

Finally a hook with the "brute" strength to hold heavy cables without sagging. Large 3/8" diameter wire with increased distance between arms to fit bulky cable coils. Black hook fits both slatwall and pegboard. Must Order Label Holders Separately.

- SA-420 8" .....\$10.10



SA420

## METAL WALL PLATE

Basic black! The "safe" design choice that always looks great with any home decor. Popular wall hugging, front face style with sturdy metal wall plate. Mounting screws and wall anchors included.

- SA30 .....\$19.70



SA30

## COMBO WALL PLATE

Destined to be your hottest seller. Designed specifically for the "contemporary" tastes of the 15 to 35 age group. A young generation that loves the look of traditional wood, but wants to add their own finishing touches of natural metals. The result is a very striking design statement that has even swayed many of the older generation. Mounting screws and wall anchors included.

- SA36 .....\$26.25



SA36

## STAND/POLE CLIPS

Clips convert any Sho-All label or sign holder for mounting on stands of any size including: music stands, mic stands, drum hardware, and large diameter speaker/light stands and rack tubing.

- SA-609 Small Pole.....\$.95
- SA-610 Medium Pole......95

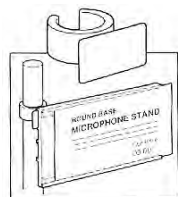

SA609

## MODULAR STRING RACKS

Here's a string rack that really works. The 24" rack width fits perfectly on the SA-4W 4-Way display or wire grid panels, or use them side-by-side on a wall for longer rows. Rack is tilted upward to keep strings from flipping forward and to make it easy to see into lower racks. The label holder fits standard 1.25" x 3" price tickets. The guitar rack has 5 bins and the bass rack has 3 bins. Bin holds up to 14 string sets. The bass rack also fits CD's. Fits slatwall or pegboard. Black coated.

- SA-781 Guitar String Rack/5 bin .....\$54.00

- SA-782 Bass Rack/3 bin .....\$61.00

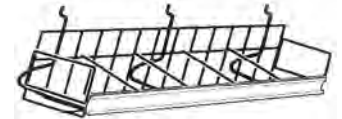

SA781

## ADHESIVE HANG TABS

Add to boxes and packages to convert to hanging style of display. The double-style tabs fit both single and double hooks. The J-style tab makes it possible to remove items from the back of the hook, without removing the other items.

- SA-480 J-Hook.....\$.12



SA480

## WOOD WALL PLATE

New elegant concave shape. It's not surprising that the rich, traditional look of wood is often preferred by acoustic players. But even the "plugged-in" electric players will appreciate how nicely this lightly oiled, natural oak wall plate blends into any room setting. Mounting screws and wall anchors included.

- SA32 .....\$26.95



SA32

## ADJUSTABLE ANGLE TRAY

An innovative idea to solve a variety of accessory display needs. The Ingles' Sho-All modular Accessory Tray with angle/slope adjustment makes it easy to convert from one application to another.

- SA235 .....\$92.25



SA235

## MALLET BASKET

Anyone selling mallets quickly discovers they can eat up a lot of valuable display space. Ingles' Sho-All Mallet Baskets will allow you to display the same amount of inventory in as little as 1/3 the space. That's a huge space savings! Five dividers are included and can be positioned at any point along the width. A label holder is included for standard 1.25" X 3" price tickets.

- SA705 .....\$93.40



SA705

# INGLES SHO ALL

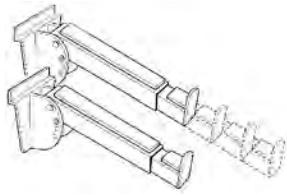

SA308

## ADJUSTABLE KEYBOARD ARMS

4-stop, length adjustable keyboard arms quickly adjust from 13" to 19" (or anywhere in-between) with just a push of a button. Use for either keyboards or mixers. Great for 3-tier setups where you can extend each lower tier further out - making them easier to see and access. Each arm is also angle adjustable. Padded contact points. Fits slatwall.

SA-308 Black.....\$100.15



SA701

## SLATWALL CYMBAL ARM

Sho-All cymbal arms accommodate different cymbal sizes. This feature makes it possible to make compact cymbal display setups. Black coated with special rubber tip.

SA-701 12.5" .....\$18.25  
SA-708 9.5" .....18.25

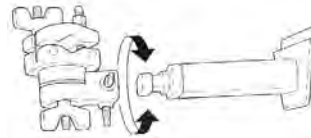

SA725

## SLATWALL GRABBER CLAMP

The possibilities are endless. This universal grabber clamp assembly makes it possible to display a wide variety of products on slatwall. When combined with drum rack hardware it works like an erector set where you are limited only by your imagination.

SA-725 .....\$84.40

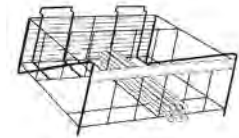

SA704

## MODULAR DRUMSTICK RACK

Drumstick display has never been easier. This modular, 6 bin rack can be stacked 3 or 4 high on a counter top or shelf. It can also be hung on slatwall in multiples to create a drumstick wall. Each stick bin holds up to 19 pair (114 pair per rack). Black coated. 15" d x 19.5" w x 6" h.

SA-704 .....\$84.40

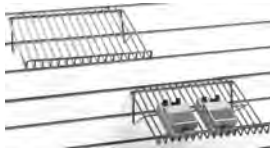

SA752

## ELECTRONICS SHELF

Designed specifically for the display of small electronics. Shelf is angled to enhance product presentation. Wire construction makes it easy to secure electronics to shelf with Sho-All cable ties. 12" w x 10.5" d. Black.

SA-752 .....\$46.15

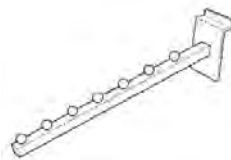

SA209

## CLOTHING WATERFALL

Display your "logo wear" clothing products just like the department stores. This slatwall waterfall bracket makes it easy. Fits slatwall and slat-style wire grid. Black coated.

SA-209 .....\$24.75

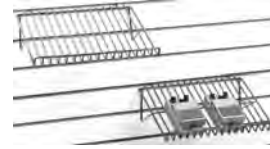

SA752

## ELECTRONICS SHELF

Designed specifically for the display of small electronics. Shelf is angled to enhance product presentation. Wire construction makes it easy to secure electronics to shelf with Sho-All cable ties. 12" w x 10.5" d. Black.

SA-752 .....\$46.15



SA402

## SINGLE HOOKS

Sho-All single hooks are not only more affordable, they have more features. They fit both slatwall and pegboard and have a 1/4" ball-end tip to provide a safe display environment. Black coating is standard.

SA-402 6" Hook .....\$1.26

**FAX & E-MAIL ORDERS FOR  
PRINTED MUSIC WILL GET AN EXTRA  
5% DISCOUNT**

**FAX:  
(708) 496-2130 • (888) 983-5537**

**E-MAIL:  
sales@harristeller.com**



SA230

## ROTATING STRAP HANGER

More straps can now be displayed in less space. Rotating slatwall rack is designed to accommodate even the widest strap. Holds over 50 straps. Use on freestanding fixtures (such as SA-4W 4-Way display) or wall mounted. Black coated.

SA-230 .....\$56.25

# INGLES SHO ALL

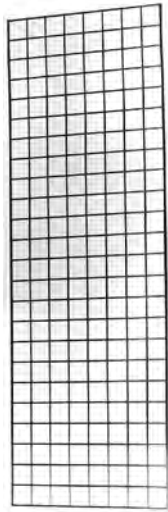

## STANDARD GRID PANEL

A 2 ft. by 6 ft. wire grid panel. Made of 1/4 inch rod, 3 inch on center (horizontal & vertical) with double side bars. All SHO-ALL grid hooks and accessories fit on this grid panel. Black coated.

SA-WG1 .....\$114.75

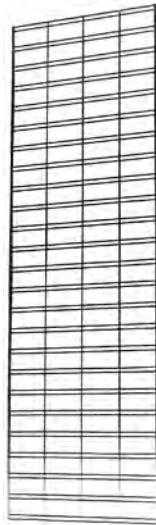

## SLAT-STYLE GRID PANEL

Our most popular 2 ft. by 6 ft. wire grid panel. Made with 1/4 inch rods (3/4 inch on center) that match a slatwall channel. Many SHO-ALL "slatwall" hooks and accessories fit on this special grid panel. Black coated.

SA-WG2 .....\$151.90

## JOINER CLIP

Use this clip to connect multiple grid panels. Virtually any configuration is possible. Black coated. 4 pack.

SA-103 .....\$12.40

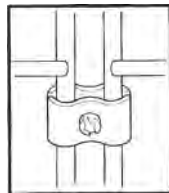

SA103

## T-LEG FOR GRID PANELS

Legs bolt onto each side of the wire grid to convert a single grid panel into a freestanding display. T-shaped leg makes it possible to display product on both sides of the panel. Black coated to match the black grid. 2 pack.

SA-101 .....\$86.65

SA101

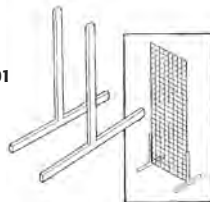

## WALL MOUNTING BRACKETS FOR GRID

Use these brackets to secure wire grid panels to a wall. Holds grid away from the wall surface to accommodate for attaching and removing hooks and accessories. 2 pack. Black coated.

SA-102 .....\$15.75

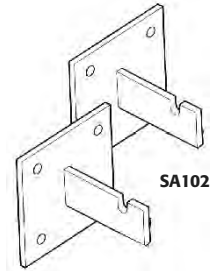

SA102

## WIRE SHELF FOR GRID

A 24" wide by 15" shelf made of wire for use on wire grid panels. Perfect for display of boxed products and larger items. Shelf width matches width of grid panels. Black coated.

SA-104 .....\$51.75

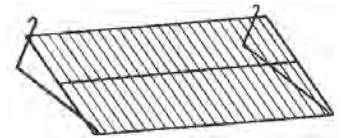

SA104

## WIRE DISPLAY BASKETS

Fill them with product to draw attention, or use them as dump bins for closeout products. The tighter wire spacing of the SA-205 and SA-206 makes it possible to display even the smallest items without fear of them slipping through. Fits slatwall or peg-board. Black coated.

SA-204 Basket 12"Wx12"Dx8"H...\$54.00

SA-206 Basket 12"Wx6"Dx6"H.....\$9.65



SA204

## VIDEO/BOOK SHELF

Here's a modular shelf that makes display of videos, audio tapes and special manuals a snap. It's angled towards the back to keep items from falling forward. Use it individually or end-to-end for greater lengths. 24" wide by 5" deep. Fits slatwall. Black coated.

SA-208 .....\$31.50



SA208

## REMARKABLE SWIVEL HOLDER

All of the exclusive "Remarkable" features with a yolk that swivels to hold guitar in either left, right or front facing position. You can change your display direction without having to buy new hooks. Ribbed yolk and locking slatwall plate.

SA341SBK Black .....\$21.00



## ASK ABOUT OUR PRINT MUSIC DEPARTMENT

FAX:  
(708) 496-2130  
(888) 983-5537

E-MAIL:  
sales@harristeller.com

FAX & E-MAIL ORDERS  
FOR PRINTED MUSIC  
WILL GET AN EXTRA  
**5% DISCOUNT**

# INGLES SHO ALL

## MODULAR WIRE SHELF

It's sized to fit perfectly on a 4-way display or slat-style grid panel. Place end-to-end on a wall or gondola when a longer length is desired. Surface wires are tightly spaced to make it possible to display smaller items. A label holder is included that holds standard 1.25" x 3" price tickets. Black coated. 24" w X 12" d.

SA-218 .....\$70.90



SA218

## CLEAR FRONT 1.25" X 3" LABEL HOLDER

Sign tickets are fully enclosed. Clear plastic cover keeps signs clean and secure in the holder. 1.25" x 3" label holder fits scanner hooks, all mounting clips and easel adapters.

SA-603 .....\$1.50



SA603



SA201

## SHELF BRACKETS

You won't find a better priced pair of brackets. Quality steel brackets can be used with glass or wood shelves of any length. Fits slatwall and slat gridwall. Black coated.

SA-201 8" .....\$29.25 Pr.  
SA-202 10" .....\$31.50 Pr.  
SA-203 12" .....\$29.25 Pr.  
SA-210 14" .....\$32.65 Pr.

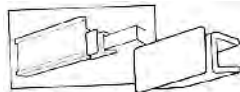

SA607

## SHELF CLIPS

Use to convert any Sho-All label or sign holder for mounting on wood or glass shelf front.

SA-607 Glass Shelf .....\$1.90  
SA-608 Wood shelf .....\$.90



SA901

## STANDARD/FLAT SECURITY CABLE

A Sho-All exclusive "dual fastening" product connector makes it possible to use high-strength adhesive pads, cable ties or both pads and ties for worry free connection to the product.

SA-901 .....\$24.75



SA207

## LITERATURE HOLDER

This clever holder is made in two pieces to make it possible to adjust the width. Fits virtually any brochure, catalog or sales literature. Use the holder on your displays to keep sales literature right next to the product. Fits slatwall. Black coated.

SA-207 Literature Rack/  
slatwall .....\$24.75

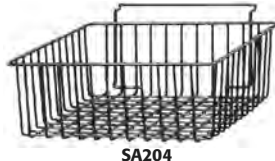

SA204

## WIRE DISPLAY BASKETS

They are so handy you'll want to have a few in each size. Fill them with smaller products or use them as dump bins for closeout products. Fits slatwall. Black coated.

SA-204 Basket 12"Wx12"Dx8"H. ....\$54.00  
SA-206 Basket 12"Wx6"Dx6"H .....\$59.65



SA902

## UNIVERSAL/CURVED SECURITY CABLE

The unique curved surface product connector makes it perfect for microphones, stands/hardware, horns and other hard-to-connect items. The flat side of the connector can also be used, making it possible to use this universal cable for most products in your store.

SA-902 .....\$24.75



SA208

## VIDEO/BOOK SHELF

Here's a modular shelf that makes display of videos, audio tapes and special manuals a snap. It's angled towards the back to keep items from falling forward. Use it individually or end-to-end for greater lengths. 24" wide by 5" deep. Fits slatwall. Black coated.

SA-208 .....\$31.50

## ONE-PIECE LITERATURE HOLDERS

SA-211 Regular Holder/1.25" deep .....\$20.25  
SA-212 Deep Holder/2.375" deep .....\$20.25

## 4/STEPPED LITERATURE HOLDER

SA-216 .....\$56.25



SA216

## ADJUSTABLE ANGLE TRAY

An innovative idea to solve a variety of accessory display needs. The Ingles' Sho-All modular Accessory Tray with angle/slope adjustment makes it easy to convert from one application to another.

SA235 .....\$92.25



## SLATWALL SCANNER HOOKS

### SINGLE SLATWALL SCANNER HOOK

SA-427 4" .....\$2.90  
SA-428 6" .....\$3.50  
SA-429 8" .....\$3.95



SA427

## MODULAR DRUMHEAD BASKET

A fast and easy way to organize your drumhead inventory. Each drumhead basket can accommodate most popular drumhead sizes (even many bass drumheads). Two dividers are included and can be inserted at any point along the width of the basket. Each basket holds up to 32 heads. Folds compact for shipping. Black coated. 24" w X 15" d X 12" h.

SA-706 .....\$58.50



SA706

# STRING SWING SLATWALL HOLDERS



**HH17BK** Saxophone .....\$39.00  
**HH18BK** French Horn .....28.80



**HH12BK** Trumpet.....\$23.99  
**HH12HBK**TPT, Horizontal .....18.90  
**HH16BK** Trombone .....35.98



**HH11BK** Soprano Sax.....\$28.80  
**HH13BK** Clarinet .....18.80



**HH14BK** Baritone.....\$46.20



**HH15BK** Flute.....\$13.40  
**HH15PBK** Piccolo.....10.20



**CC16M** 1 Microphone .....\$14.70  
**CC166** 6 Microphone .....41.98



**SCH6BK** 6" Hook .....\$7.50  
**SCH10BK** 10" Hook .....7.50  
**HH196BK** 6" Padded Hook.....10.50  
**HH1910BK** 10" Padded Hook..10.50



Multi Angle Cymbal Arm  
**CD9MABK** 6"-14" Cymbal .....\$15.60  
**CD12MABK** 14"-22" Cymbal .....15.90  
 Straight Cymbal Arm  
**CD12** 14" - 22" Cymbal .....\$12.60



**BANJO HOOKS**  
**CBF** .....\$14.10  
**CC03RL3B** Multi Angle.....17.10



**VIOLIN HOOKS**  
**CVF** Front Facing.....\$13.20  
**CC01V** w/BowHolder.....14.70  
**MA5V** Multi Angle.....18.50  
**CC04V** Mic Stand Hook.....15.00



**CELLO/BASS**  
**HH08BK** Neck Support .....\$18.00  
**HH10BK** Bass Wall Stand .....96.00



**VIOLIN/MANDOLIN**  
 2 Pc. Holder  
**CC155** .....\$39.30



**TUBA/SOUSAPHONE**  
**HH09BK** .....\$96.00



**BARI SAX**  
**HH27BK** .....\$47.70



**DRUM ACCESSORY POLE**  
 For Slat Wall  
**DAP** .....\$25.80



Sliding Display Shelf. 12" wide.  
 Displays drum machines, etc.  
**CC09S** Slanted.....\$44.98

# STRING SWING SLATWALL HOLDERS



**PARKER GUITAR**  
**PKF** Front .....\$13.80  
**PKL** Left .....13.80  
**PKR** Right.....13.80



**PARKER GUITAR**  
**PKFB** Full Body .....\$19.50



**KICK PEDAL DISPLAY**  
**KPD** Holds 10 .....\$195.00



**CC31** P/U Jack Tool.....\$21.00B  
**CC18** Ferrule Tool .....21.00B



**STRING RACKS**  
**GSR** Guitar, holds  
 9 dz. sets .....\$119.99  
**BSR** Bass, holds 4 dz. sets 104.99



**DISPLAY HOOKS**  
 Wood Base, Mounts On Wall  
**CC01UK** Uke/Mandolin.....\$14.70  
**CC01D** Dulcimer .....14.70



**CCKTA** 3 Angle, 12"-22"  
 Adjustable .....\$66.00 pr.



**DJEMBE HOLDERS**  
**SSHH30** 10" Holder .....\$22.20  
**SSHH31** 14" Holder .....27.00  
**SSHH33** 7 1/2" Holder.....21.00



**CC01B** Banjo, Wood  
 Bracket.....\$14.70  
**CC03RL3B** Banjo, Multi Facing ..17.10



**CC01V** Violin w/Bow  
 Holder .....\$14.70



**CC01UK** Uke Holder.....\$14.70



**CC01N**.....\$13.65

www.stringswing.com

## GRIP STUDIOS

### WALL MOUNT HOLDERS

Machined and balanced so your instrument fits securely.



**FEMALE  
 HAND STANDS**  
 (Face Left)



<b>LHGH118</b> Purple Sparkle (Female).....	<b>\$47.95</b>	<b>LHGH104</b> Pearlized White.....	<b>\$47.99</b>
<b>LHGH119</b> Pink Sparkle (Female).....	<b>47.95</b>	<b>RHGH104R</b> Pearlized White.....	<b>47.95</b>
<b>LHGH120</b> Silver Sparkle (Female).....	<b>47.95</b>	<b>LHGH105</b> PennyWise.....	<b>47.99</b>
<b>LHGH121</b> Ocean Turquoise (Female).....	<b>47.95</b>	<b>RHGH105R</b> PennyWise.....	<b>47.95</b>
<b>LHGH122</b> Lake Placid Blue (Female).....	<b>47.95</b>	<b>LHGH111</b> Bluester.....	<b>47.99</b>
<b>LHGH123</b> Shoreline Gold (Female).....	<b>47.95</b>	<b>LHGH111R</b> Bluester.....	<b>47.99</b>
<b>LHGH101</b> Metal Mayhem.....	<b>47.99</b>	<b>AXCENT SERIES</b>	
<b>RHGH101R</b> Metal Mayhem.....	<b>47.99</b>	<b>LHGH103</b> Grip Reaper.....	<b>\$48.95</b>
<b>LHGH102</b> Red Rum.....	<b>47.99</b>	<b>LHGH107</b> Monster-Green.....	<b>48.95</b>
<b>RHGH102R</b> Red Rum.....	<b>47.95</b>	<b>LHGH108</b> Monster-Red.....	<b>48.95</b>
<b>LHGH106</b> Black Pearl.....	<b>47.99</b>	<b>LHGH114</b> Bella Rose.....	<b>55.00B</b>
<b>RHGH106R</b> Black Pearl.....	<b>47.95</b>	<b>LHGH115</b> Ent-Wistle.....	<b>55.00B</b>
		<b>LHGH117</b> Torch Tip Black/Silver.....	<b>55.00B</b>
		<b>LUMPY STUMPY</b>	
		<b>GH114</b> .....	<b>\$39.99</b>

## WRISTIES



Uses: outdoor performances, chilly venues, injury prevention. Materials and care: 49% Polyester, 38% Nylon, 13% Spandex. Machine wash, warm, tumble low or line dry. Made in USA.

**WRPS** Small .....\$24.99 pr.  
**WRPM** Medium.....24.99 pr.  
**WRPL** Large.....24.99 pr.

## Men's Wear



### Spaghetti Logo T-Shirt

100% pre-shrunk cotton, with full front screen prints, taped neck and shoulders, and double-needle stitching. The Fender spaghetti logo is on the front.

<b>1000306</b>	Black S .....	<b>\$21.99</b>
<b>1000406</b>	Black M .....	<b>21.99</b>
<b>1000506</b>	Black L .....	<b>21.99</b>
<b>1000606</b>	Black XL .....	<b>21.99</b>
<b>1000806</b>	Black XXL .....	<b>24.99</b>



### Rock On T-Shirt

100% pre-shrunk cotton, with full front screen prints, taped neck and shoulders, and double-needle stitching. The Fender logo with "Rock On" hand symbol – front.

<b>1001346</b>	Army Green S .....	<b>\$21.99</b>
<b>1001446</b>	Army Green M .....	<b>21.99</b>
<b>1001546</b>	Army Green L .....	<b>21.99</b>
<b>1001646</b>	Army Green XL .....	<b>21.99</b>
<b>1001846</b>	Army Green XXL .....	<b>24.99</b>



### Amp Logo T-Shirt

50/50 poly/cotton, with full front screen prints, taped neck and shoulders, and double-needle stitching. The Fender amp logo is on the front.

<b>0010304</b>	Blue S .....	<b>\$21.99</b>
<b>0010404</b>	Blue M .....	<b>21.99</b>
<b>0010804</b>	Blue XXXL .....	<b>24.99</b>



### Lightning Bolt Logo T-Shirt

100% pre-shrunk cotton, with full front screen prints, taped neck and shoulders, and double-needle stitching. The lightning bolt logo was used by Leo Fender in 1946 on a Fender® lap steel guitar – front.

<b>1008421</b>	Brown M .....	<b>\$21.99</b>
<b>1008521</b>	Brown L .....	<b>21.99</b>
<b>1008621</b>	Brown XL .....	<b>21.99</b>
<b>1008821</b>	Brown XXL .....	<b>24.99</b>



### Amp Logo T-Shirt

50/50 poly/cotton, with full front screen prints, taped neck and shoulders, and double-needle stitching. The Fender amp logo is on the front.

<b>0010369</b>	Charcoal S .....	<b>\$21.99</b>
<b>0010469</b>	Charcoal M .....	<b>21.99</b>
<b>0010569</b>	Charcoal L .....	<b>21.99</b>
<b>0010669</b>	Charcoal XL .....	<b>21.99</b>
<b>0010869</b>	Charcoal XXXL .....	<b>24.99</b>



### Trademark T-Shirt

100% pre-shrunk cotton, with full front screen prints, taped neck and shoulders, and double-needle stitching. The Genuine Trademark Fender is on the front.

<b>1009321</b>	Sand S .....	<b>\$21.99</b>
<b>1009421</b>	Sand M .....	<b>21.99</b>
<b>1009521</b>	Sand L .....	<b>21.99</b>
<b>1009821</b>	Sand XXL .....	<b>24.99</b>



### Amp Logo T-Shirt

50/50 poly/cotton, with full front screen prints, taped neck and shoulders, and double-needle stitching. The Fender amp logo is on the front.

<b>0010321</b>	Chocolate S .....	<b>\$21.99</b>
<b>0010421</b>	Chocolate M .....	<b>21.99</b>
<b>0010521</b>	Chocolate L .....	<b>21.99</b>
<b>0010621</b>	Chocolate XL .....	<b>21.99</b>



### Revival T-Shirt

100% pre-shrunk cotton, with full front screen prints, taped neck and shoulders, and double-needle stitching. Revival artwork is on the back.

<b>1010343</b>	Grey S .....	<b>\$21.99</b>
<b>1010443</b>	Grey M .....	<b>21.99</b>
<b>1010543</b>	Grey L .....	<b>32.85</b>
<b>1010643</b>	Grey XL .....	<b>32.85</b>
<b>1010843</b>	Grey XXL .....	<b>24.99</b>

(BACK OF SHIRT)

## Men's & Women's Wear/Barstools



### Taking Over Me T-Shirt

100% pre-shrunk cotton, with full front screen prints, taped neck and shoulders, and double-needle stitching. Fender Custom Shop logo on the front and a Jaguar guitar print on the back.

<b>1020306</b>	Black S.....	<b>\$21.99</b>
<b>1020406</b>	Black M.....	<b>21.99</b>
<b>1020506</b>	Black L.....	<b>21.99</b>
<b>1020606</b>	Black XL.....	<b>21.99</b>
<b>1020806</b>	Black XXL.....	<b>24.99</b>



### Heavens Gate T-Shirt

100% pre-shrunk cotton, with full front screen prints, taped neck and shoulders, and double-needle stitching. Fender Custom Shop logo with an intricate swirl design on the front.

<b>1040306</b>	Black S.....	<b>\$21.99</b>
<b>1040406</b>	Black M.....	<b>21.99</b>
<b>1040506</b>	Black L.....	<b>21.99</b>
<b>1040606</b>	Black XL.....	<b>21.99</b>
<b>1040806</b>	Black XXL.....	<b>24.99</b>



### Blue Bird T-Shirt

100% pre-shrunk cotton, with full front screen prints, taped neck and shoulders, and double-needle stitching. Logo banner across the top of a Fender eagle on front.

<b>1030306</b>	Black S.....	<b>\$21.99</b>
<b>1030406</b>	Black M.....	<b>21.99</b>
<b>1030506</b>	Black L.....	<b>21.99</b>
<b>1030606</b>	Black XL.....	<b>21.99</b>
<b>1030806</b>	Black XXL.....	<b>24.99</b>



### Ladies' Spotlight T-Shirt

100% cotton. Step into the spotlight with this classic black ladies tee. The classic logo is reminiscent of the early days on Pomona Avenue.

<b>0042306</b>	Black S.....	<b>\$21.99</b>
<b>0042506</b>	Black L.....	<b>21.99</b>
<b>0042606</b>	Black XL.....	<b>21.99</b>



### Custom Shop Pinstripe Barstool

This premium quality Custom Shop Pinstripe barstool is constructed from a heavy gauge 1" tubular steel frame with a lustrous chrome plated finish. The thick foam padded seat top consists of commercial grade vinyl and displays the Custom Shop Spade logo. The seat also rotates on a 360 degree revolving swivel. Some assembly is required. Available in 24" and 30" heights.

<b>0230010</b>	30" high.....	<b>\$99.99</b>
<b>0230020</b>	24" high.....	<b>89.99</b>



### Logo Barstool

This 24" "Shorty" barstool is perfect for sitting and playing, and you don't have to fall quite so far either! Or, you can belly up the bar with the 30" barstool! This baby will make you feel like you're in a place where, well, everybody knows your name! Cheers! Some assembly required.

<b>0205010</b>	30" high.....	<b>\$99.99</b>
<b>0205020</b>	24" high.....	<b>107.45</b>



## Head Wear & Collectibles



### Logo Stretch Caps

Classic stretch twill baseball cap fits comfortably without adjustment. Raised embroidery shows the Fender logo across the front and a Fender guitar pick with the Fender "F" on the back. Both comfy and cool!

<b>6000306</b>	Black S/M .....	<b>\$21.99B</b>
<b>6000506</b>	Black L/XL .....	<b>21.99B</b>
<b>6000302</b>	Blue S/M .....	<b>21.99B</b>
<b>6000502</b>	Blue L/XL .....	<b>21.99B</b>



### Beanies

For more than 60 years the Fender® brand has been synonymous with the Spirit of Rock & Roll™. Fender Headwear is based on this rock & roll history and the rock legends that use Fender instruments. Available in Black. One size fits most.

<b>6111706</b>	Black .....	<b>\$17.99B</b>
----------------	-------------	-----------------



### Logo Stretch Cap – Red

Classic stretch twill baseball cap fits comfortably without adjustment. Raised embroidery shows the Fender logo across the front and a Fender guitar pick with the Fender "F" on the back. Both comfy and cool!

<b>6000309</b>	Red S/M .....	<b>\$21.99B</b>
<b>6000509</b>	Red L/XL .....	<b>21.99B</b>



### Beanies

For more than 60 years the Fender® brand has been synonymous with the Spirit of Rock & Roll™. Fender Headwear is based on this rock & roll history and the rock legends that use Fender instruments. Available in Red. One size fits most.

<b>6111709</b>	Red .....	<b>\$17.99B</b>
----------------	-----------	-----------------



### Logo Stretch Cap – White

Classic stretch twill baseball cap fits comfortably without adjustment. Raised embroidery shows the Fender logo across the front and a Fender guitar pick with the Fender "F" on the back. Both comfy and cool!

<b>6000305</b>	White S/M .....	<b>\$21.99B</b>
<b>6000505</b>	White L/XL .....	<b>21.99B</b>



### Beanies

For more than 60 years the Fender® brand has been synonymous with the Spirit of Rock & Roll™. Fender Headwear is based on this rock & roll history and the rock legends that use Fender instruments. Available in White. One size fits most.

<b>6111705</b>	White .....	<b>\$17.99B</b>
----------------	-------------	-----------------



### "Big F" Logo Stretch Cap – Black

Classic baseball cap made of stretch twill so it will fit comfortably without needing adjustment. Raised embroidery features a large Spaghetti Logo "F" in the center.

<b>6010306</b>	Black S/M .....	<b>\$24.99B</b>
<b>6010506</b>	Black L/XL .....	<b>24.99B</b>
<b>6010309</b>	Red S/M .....	<b>24.99B</b>
<b>6010509</b>	Red L/XL .....	<b>24.99B</b>



### Headstock Logo Keychain

Made from pewter. Stratocaster headstock.

<b>0550117</b>	.....	<b>\$9.99B</b>
----------------	-------	----------------



### Pick Logo Keychain

Made from pewter.

<b>0550217</b>	.....	<b>\$9.99B</b>
----------------	-------	----------------



### Custom Shop Stretch Cap – Black

Classic stretch twill baseball cap fits comfortably without adjustment. Raised embroidery shows the Custom Shop logo and "When You're Ready" across the front.

<b>6011306</b>	Black S/M .....	<b>\$21.99B</b>
<b>6011506</b>	Black L/XL .....	<b>21.99B</b>



### Bass Tuning Key Logo Keychain

Made from pewter.

<b>0550317</b>	.....	<b>\$9.99B</b>
----------------	-------	----------------

# ERNIE BALL APPAREL



**King of Strings T-Shirt M**  
EB4701 Male.....\$22.00



**King of Strings T-Shirt L**  
EB4702 Male.....\$22.00



**King of Strings T-Shirt XL**  
EB4703 Male.....\$22.00



**King of Strings T-Shirt XXL**  
EB4704 Male.....\$22.00



**Strings & Things T-Shirt Medium**  
EB4189 Male.....\$18.00  
EB4621 Female (Small).....\$32.00



**Strings & Things T-Shirt Large**  
EB4190 Male.....\$18.00  
EB4622 Female (Medium) ..\$32.00



**Strings & Things T-Shirt XL**  
EB4191 Male.....\$18.00  
EB4623 Female (Large).....\$32.00



**Ernie Ball Large/X-Large Cap**  
Flex Fit  
EB4169.....\$22.00



**Aluminum Bronze T-Shirt M**  
EB4745 Male.....\$32.00



**Aluminum Bronze T-Shirt L**  
EB4746 Male.....\$32.00



**Aluminum Bronze T-Shirt XL**  
EB4747 Male.....\$32.00



**Mason Large/X-Large Cap**  
Flex Fit  
EB4171 .....\$22.00

# INDEX

## A

A B Boxes 275, 309  
A/C Adaptors 285, 287, 300, 339  
Accordions 346  
Accordion Straps 346  
Ace Straps 42, 422  
Acme Whistles 160  
Adamas Strings 55  
Afuche (Cabasa) 156, 161  
Agogo Bells 156  
AIM Music Gifts 428, 429  
Alisyn Lubricants 69, 419  
Alto Sax 402  
Amplifiers 304, 332, 335, 336  
  Belcat 334  
  Blackstar 304  
  Boulder Creek 332  
  Honeytone 336  
  Hot Spot 337  
  Johnson 335  
  Pignose 336  
  VOX 304, 335  
Amplifier Casters 330  
Amplifier Corners 330  
Amplifier Glides 330  
Amplifier Handles 330  
Amplifier Speaker Parts 330  
Amplifier Stands 333, 334  
Angel Recorders 349  
Aquarian Drum Heads 218, 219  
Aquila Strings 61  
ART 308, 309  
Atlas Stands 250  
Attack Heads 217  
Aubert Bridges 374  
Audio Adaptors 260, 261, 268, 270, 271  
Audio Technica Headphones 246  
Audio Technica Mics 235-237, 242, 243  
Audix Microphones 241  
Augustine Strings 58  
Aulos Recorders 349  
Award Pins 427-429

## B

Bach Mouthpieces 392  
Bach Mutes 396  
Baggs, L.R. Pickups 284  
Bagpipes 171  
Bags, Band Instruments 403  
  Cello/Bass 371  
  Cymbal 142, 182, 183  
  Drum 182, 183  
  Guitar 19, 21, 91  
  Keyboard 339, 341  
  Music Stand 357-359  
  Paper 427  
  Poly 427  
  Stick/Mallet 207, 208  
Ball, Ernie Apparel 442  
Ball, Ernie Picks 103  
Ball, Ernie Pedals 290  
Ball, Ernie Polish 71  
Ball, Ernie Pots 95  
Ball, Ernie Straps 41  
Ball, Ernie Strings 52, 53  
Ball, Ernie Switches 95  
Balter Mallets 200, 201  
Band Instrument Accessories 381-425  
Band Instrument Cases 403  
Band Instrument Stands 404-407  
Band Instrument Straps 420-422  
Banjos 4, 5, 6, 13  
Banjo Arm Rests 117  
Banjo Bridges 100  
Banjo Capos 73  
Banjo Cases 19, 21  
Banjo Heads 214  
Banjo Lug Sets 117

Banjo Mutes 117  
Banjo Pegs 117  
Banjo Pitch Pipes 69  
Banjo Straps 32, 41, 42, 44  
Banjo Tailpieces 117  
Banjo Wrenches 117  
Bari Mouthpieces 389  
Bari Reeds 384  
Baritone Ukles 12, 13, 15, 17  
Bass Bags 371  
Bass Bows 370  
Bass Drum Kick Pads 230  
Bass Drum Pedals 143, 144, 146, 180  
Bass Drum Pedal Beaters 146, 154  
Bass Drum Pedal Springs 146, 149  
Bass Guitars 6, 7  
Bass Guitar Machines 112-116  
Bass Violins 368-370  
Bass Violin Bridges 374  
Bass Violin Endpins 371  
Bass Violin Strings 377-380  
Bassoon Reeds 381, 382  
Batons 352, 353  
Batteries 286  
Beato Bags 183  
Bell Sets 173  
Berp Extensions 391  
Berg Larsen Mouthpieces 389  
Bigsby Vibratos 99  
Black Diamond Strings 62, 380  
Black Swamp Percussion 175, 177, 198  
Blackstar Pedals 305, 306  
Blessing Instruments 400, 401  
Blessing Mouthpieces 393  
Blue Juice 419  
Bois Ligatures 412  
Bonade Ligatures 410  
Bongos 162, 163, 170  
Bongo Heads 162-164, 214, 215, 228  
Bongo Stands 163  
Boom Arms 250-255  
Boomwhackers 207  
Bore Cleaners 408, 415  
Boss Pedals 295  
Bottleneck Slides 74, 75  
Boulder Creek Amps 332  
Bow Hair 372  
Bows 370  
Brace Guard 395  
Bridges 84, 96-100  
Bridge Pins 94, 95  
Brillhart Mouthpieces 390  
Bugles 402  
Bulb Horn 160  
Bundy Mouthpieces 390

## C

Cabasa 156, 161  
Cable Tester 263, 268  
Cable Ties 249  
CAD Audio 238, 239  
Cajons 163, 166  
Cambridge Recorders 349  
Cannon Percussion 150, 151  
Capos 73  
Cases, Band Instrument 403  
  Banjo 19, 21  
  Drum 182  
  Guitar 19-22  
  Microphone 244  
  Rock Mount 330-332  
  Violin 371  
Case Handles 17  
Case Hardware 17  
Case Tags 403, 429, 430  
Casio Keyboards 338, 339  
Cass, Al Oil 419  
Castanets 161, 198

Cellos 368-370  
Cello Bags 371  
Cello Bows 370  
Cello Bridges 374  
Cello Endpins 371  
Cello Stand 372  
Cello Strings 377-380  
Chartier Reeds 381  
Chauvet Lighting 325-328  
Cherub Metronomes 425  
Cherub Tuners 319, 324  
Chime Trees 123, 124  
Chop Saver 391, 395  
Choral Filing Boxes 359  
Choral Folders 359  
Chord Stamps 72  
Chromaharps 18  
Claricord Strap 420  
Clarinet Outfits 402  
Claude Lakey Mouthpieces 391  
Claves 161  
Clayton Picks 110  
Cleartone Strings 62  
Clip Light 362  
Concert Bass Drum Stands 179  
Concert Cymbal Stands 143  
Concert Snare Stands 143  
Concertinas 346  
Congas 164  
Conga Bags 164, 183  
Conga Heads 164, 214, 215, 228  
Conga Stands 164  
Conquest Sound Cords 264, 265  
Conn Lubricants 419  
Cool Cat Pedals 290  
Cords 261-273  
Cork Grease 419  
Cowbell Holders 158  
Cowbells 156, 158  
Crotales & Holders 139  
Crown, Tom Mutes 397  
Cruz Tools 23  
Cry Baby Pedals 287  
Cymbals 125-141  
Cymbal Arms 142, 150  
Cymbal Cases 142, 182, 183  
Cymbal Pads 139  
Cymbal Polish 141  
Cymbal Pouches 142, 182, 183  
Cymbal Sizzler 141  
Cymbal Springs 141  
Cymbal Stands 143, 144, 147, 180

## D

D'Addario Strings 46-50, 378  
D'Andrea Straps 42  
Dampits 22, 376, 417  
D'Andrea Picks 103, 104  
D'Angelico Strings 58  
Danelectro 290, 292, 293  
Darco Strings 51  
Dava Picks 109  
DEG Accessories 394, 404, 412  
DEG Mouthpieces 393  
Didjeridoos 160  
DiMarzio Parts 87  
DiMarzio Pick-Ups 278, 279  
DiMarzio Straps 44  
Direct Boxes 274, 275, 308, 309  
Directors Batons 352, 353  
Disinfectants 410  
Display Products 118, 432-438  
Djembes 165-170  
Djembes Bags 165, 182  
Djembes Stands 165, 167  
Don't Fret 377  
Drink Holders 153  
Drum Brushes 205, 206

Drum Carriers 182  
Drum Cases 182, 183  
Drum Covers 182, 183  
Drum Heads 209-229  
Drum Holz 230  
Drum Hoops 152  
Drum Keys 154  
Drum Kick Pads 230  
Drum Mallets 185-203  
Drum Mufflers 230, 231  
Drum Parts 148-154  
Drum Pedals 143, 144, 146, 180  
Drum Practice Pads 184  
Drum Rug 153  
Drum Sets 179, 181  
Drum Slings 182  
Drum Spurs 150, 152  
Drum Stands 143, 144, 147, 180  
Drum Sticks 185-199, 204, 205  
Drum Stick Bags 207, 208  
Drum Stick Tape 207  
Drum Torque 154  
Drum Triggers 277  
Drum Workshop Hardware 146, 147  
Drummer's Gloves 148  
Drummer's Thrones 144-145, 147, 179, 180  
Dukoff Mouthpieces 388  
Dulcimers 18  
Dunlop Capos 73  
Dunlop Fret Wire 101  
Dunlop Guitar Packs 69  
Dunlop Picks 102, 105-107  
Dunlop Polish 70  
Dunlop Slides 74, 75  
Dunlop Straps 36  
Dunlop Strings 63  
Duratech Sticks 205

## E

E Bow 290  
E Rings 230  
EZ Guitar Trainer 76  
Ear Plugs 259  
Earthwood Strings 52, 53  
Ebtech 319  
Egg Shakers 155  
Electro Harmonix 298-302  
Electro Voice Mics 235  
Elixir Strings 68  
EMG Pickups 282, 283  
Emerald Reeds 381, 384  
Eminence Speakers 247, 248  
End Pin Jacks 277, 280  
Engelhardt Basses & Cellos 370  
EPM Pick Ups 277  
Equipment Cases & Bags 330-332  
Ethnic Percussion 155-165  
Evans Drumheads 220-229  
Everly Strings 62

## F

Farkas Mouthpieces 392  
Fast Fret 69  
Faxx Mouthpieces 389, 393  
Feedback Buster 23  
Felt Picks 103  
Fender Accessories 90, 91  
Fender Headwear & Collectibles 439-441  
Fender Picks 102  
Fender Pick Ups 282  
Fender Straps 44  
Fender Strings 60  
Fender T-Shirts 439, 440  
Fibracell Reeds 384  
Finger & Thumb Picks 102, 104, 109  
Finger Board Oils 69, 70  
Finger Cymbals 141

Finger Ease 69  
Finger Exercisers 23  
Firth Mallets 186-188  
Firth Sticks 186-188  
Fishman Transducers 280, 281  
Five Star Banjo Heads 214  
Flageolets 350  
Flavor Reeds 385  
Flip Folders 359  
Flute Plugs 413  
Flutes 402  
Flutist Friend Lyres 412  
Flutophones 349  
Foot Switches 269  
Fort Bryan Straps 43  
Fret Rest 101  
Fret Wire 101  
Fruit Shakers 171  
Furman 318  
Fuses 330

## G

GHS Strings 64-67  
Galaxy Audio 337  
Gem Swabs 414  
Gig Bags 19, 20-22, 91  
Gigliotti Mouthpieces 389  
Goldentone Mouthpieces 390  
Gongs 139  
Goose Necks 249  
Graph Tech Parts 78-86  
Graph Tech Picks 78, 104  
Great Dane Beaters 199  
Grip Master 23  
Grip Studio Hangers 118, 438  
Groove Tubes 258  
Grover Machines 112, 113  
Grover Pro Percussion 124, 177, 203  
Guiros 161  
Guitars 6-12, 18  
Guitar Backplates 92  
Guitar Bags 19-22  
Guitar Bodies 77  
Guitar Bridge Pins 94  
Guitar Bridges 96-100  
Guitar Cables 262-273  
Guitar Capos 73  
Guitar Cases 19-22  
Guitar Cleaners 69-71  
Guitar Effect Pedals 286-302, 305, 306  
Guitar End Pin Jacks 277, 280  
Guitar Foot Stool 23  
Guitar Hooks 118-122, 432-438  
Guitar Humidifiers 22  
Guitar Knobs 77, 87-91, 95  
Guitar Machines 112-116  
Guitar Necks 77  
Guitar Pick Holders 104  
Guitar Pickguards 91, 92  
Guitar Pick Ups 276-284  
Guitar Pitch Pipes 69  
Guitar Polishes 69-71  
Guitar Pots 77, 87, 90, 95  
Guitar Saddles 76, 79-85, 97, 99  
Guitar Slides 74, 75  
Guitar Sound Hole Covers 23  
Guitar Stands 118-122  
Guitar Straps 24-44  
Guitar Strings 46-68  
Guitar Switches 77, 87-90, 95  
Guitar Tailpieces 96-99  
Guitar Tools 23

## H

Hamel Batons 352  
Hamilton Music Stands 357  
Hamilton Microphone & Speaker Stands 255  
Hand Carts 231  
Handles 17, 330  
Hardware Bags 182, 183

Harmon Mutes 397  
Harmonicas 344-346  
Harmonica Belts & Cases 345  
Harmonica Holders 345  
Harmonica Microphones 312, 345  
HarpArm 345  
Hawkins Mouthpieces 388  
Heads, Banjo 214  
Heads, Conga 164, 215, 228  
Heads, Drum 209, 229  
Headphones 244-246  
Headphone Amps 302-304  
Hemke Reeds 385  
Herco Maint. Kits 416  
Hercules Stands 121, 253, 359, 404, 405  
Hetman Lubricants 418  
Hi-Hat Stands 143-144, 147, 179, 180  
Hipshot 96, 116  
Hite Mouthpieces 388  
Hodge, Ann Swabs 414  
Hohner Concertina 346  
Hohner Guitars 11  
Hohner Harmonicas 344, 345  
Hohner Melodicas 348  
Hohner Recorders 349  
Holton Mouthpieces 394  
Holton Oils 419  
Holz 230  
Hosa Adapters 261  
Hosa Cables 262, 263, 271  
Hot Spot Monitors 337  
Hot Sticks 205  
House of Troy Lamps 360-362  
Huang Harmonicas 346  
Hum Eliminators 319  
Humitron Humidifiers 22

## I

Ibanez Effect Pedals 291  
Innovative Perc. Mallets 196-198  
Interfaces, MIDI 307, 308  
Intellitouch Tuners 324  
iPad & Tablet Holders 355

## J

JJ Tubes 258  
Jam Blocks 153  
Jargar Strings 380  
Jaw Harps 351  
Jet Tone Mouthpieces 394  
Jewel Mouthpieces 389  
Jo-ral Mutes 396  
Juice Goose 329

## K

K & M Stands 119, 120, 122, 254, 358, 404, 406  
Kazoos 351  
Kelly, Fred Picks 109  
Keyboards 338-340  
Keyboard Bags 339, 341  
Keyboard Benches 342  
Keyboard Pedals 290, 302, 339  
Keyboard Stands 339, 342, 343  
Kickport 231  
Kid's Rhythm Instruments 169, 347, 354  
Knobs 77, 87-91, 95  
Kohala Ukcs 14, 15  
Korg Tuners 320, 321  
Koss Headphones 245  
Kun Shoulder Rests 374  
Kyser Capos 73

## L

Labella Strings 59, 380  
Lag Ukcs 14  
Lakey, Claude Mouthpieces 391  
Lamps 329, 360-363  
Lap Harps 171

Latch Lake Slides 75  
La Voz Reeds 385  
LP Claw 142, 153  
LP Products 124, 142, 156, 157, 177  
Legere Reeds 384  
Levy's Gig Bags 20  
Levy's Straps 24-32  
Ligatures 408-412  
Lighting Products 325-328  
Lighting Stands 253, 326, 343  
Lightsnake 270, 307  
Line Transformers 256  
Link, Otto Mouthpieces 389  
Littlite 329  
LM Straps 40-42, 420, 422  
Lubricants 418, 419  
Ludwig Mallets 202  
Ludwig Pedals 143  
Ludwig Stands 143  
Ludwig Tambourine 176  
Lurie, Mitchell Reeds 385  
Lute Holes 23  
Luyben Ligatures 409  
Lyres 408, 412

## M

Maestro Batons 352  
Maintenance Kits 416-418  
Malletech Mallets 193  
Mallets 185-203  
Mandolins 4-6  
Mandolin Bridges 100  
Mandolin Cases 19, 21, 22  
Mandolin Machines 115, 117  
Mandolin Straps 32, 34, 41, 44  
Mandolin Tailpieces 117  
Manhasset Stands 356  
Maracas 155, 156, 160  
Marching Band Covers 359  
Marching Gloves 420  
Marcinkiewicz Mpcs 392  
Markley, Dean Strings 54, 55  
Martin Strings 56, 57  
Marvel Guitars 11  
Marvel Guitar Straps 37  
Mathias Thoma Bases, Cellos & Violins 368  
Matrix Metronomes 425  
Matrix Tuners 322  
Maxon Effect Pedals 294  
Medals, Award 427  
Megaphones 240  
Melody Harp 353  
Melodicas 348  
Metronomes 423-425  
Meyer Mouthpieces 389  
Mic Eze 142, 256, 355  
Microphones 232-243, 312, 337  
Microphone Bell Clamps 256  
Microphone Cases & Bags 232, 244  
Microphone Holders 256, 257  
Microphone Line Transformers 256  
Microphone Mixers 275  
Microphone Pop Filters 256  
Microphone Stands 249-255  
Microphone Windscreens 256, 257  
Mighty Bright 363  
Mighty Mite Parts 77, 95  
MISI Pick Ups 277  
Mixers 275, 309  
Mollard Batons 352, 353  
Monitors 337  
Moody Screwdrivers 413  
Moon Gels 230  
Morley Pedals 286  
Moshay Picks 102  
Mouthpieces 386-394  
Mouthpiece Caps 408-412  
Mouthpiece Pullers 395  
Mouthpiece Savers 395  
Muck, Rudy Mouthpieces 392

Music Clips 359  
Music Stands 157, 356-359  
Music Stand Lights 329, 360-363  
Music Stand Storage Carts 356, 357  
Musical Spoons 160  
Musser Mallets 202  
Mutec Mouthpieces 393  
Mutec Mutes 399  
Mutes 396-399  
MXR Effects 296, 297

## N

National Picks 103  
Neck Position Markers 72, 76  
Neotech Straps 44, 421  
Neutrik Adapters & Plugs 261, 268  
Noise Filters 259

## O

Oasis Humidifiers 22  
Oboe Reeds 381-383  
Ocarinas 160, 351  
Oils 418, 419  
On-Stage Products  
Guitar Accessories 20, 23, 45, 73, 323  
Guitar Stands 119  
Drum Accessories 142, 145, 183, 199  
Keyboard Stands 342  
Keyboard Accessories 339, 341  
Amp/Mixer Stands 333  
Microphone Stands 250, 251  
Microphone Accessories 249-251, 256  
Orchestra Stands 358  
Band 407  
Lighting and Speaker Stands and Accessories 253  
Cables 269  
Snake Boxes 269  
Pedal Tuner 294  
Option Knob 289  
Oskar, Lee Harmonicas 346  
Oud 171  
O Port 72

## P

P.A. Cabinets 332, 334-336  
Pacific Drum Hardware 180  
Pacific Drum 179, 181  
Pad Savers 415  
Pad Sets 416  
Palatino Violins 369  
Pan Pipes 160  
Paper Bags 427  
Parduba Mouthpieces 392  
Patch Bay 263  
Pearse, John Strings 63  
Peavey  
Bags & Cases 20  
Guitar Straps 38, 39  
Headphones 244  
Straplocks & Buttons 45  
Strings 51  
Polish/Cloths 71  
Slides 75  
Tuner/Recorder 72  
Picks/Jack Daniel's, Marvel Picks 108  
Microphones/Packaging 232  
Portable P.A. Messenger 233, 317  
Portable P.A. Escort 3000, 5000 234, 316  
Marvel Guitars 234, 316  
Mic/Speaker Stands 252  
Microphone Holders/Windscreens 257  
Tubes 258  
Cables/Batteries/Connectors 268  
Direct Interface Boxes 274  
Peavey Accessories 310-317  
Amp Accessories 330

Pedal Beaters 146, 154  
Pedal Boards 307, 331  
Pedal Juice 285  
Peg Winders 72  
Penny Whistles 350  
Percussion Accessories 123-231  
Peterson Metronome 425  
Peterson Tuners 322  
Phantom Power Supplies 237, 309  
Piano Benches 342  
Piano Lamps 360-363  
Piano Tuning Hammers 423  
Pick Guards 91, 92  
Picks 78, 101-111  
Pick-ups 276-284  
Pignose Amps 336  
Ping Machines 114  
Pins, Award 427-429  
Pirastro Strings 380  
Pitch Pipes 69  
Planet Waves Cables 270-273  
Planet Waves Machines 115  
Planet Waves Picks 111  
Planet Waves Straps 33-35  
Planet Waves Metronome/Tuners 425  
Planet Waves Tuner 323  
Play On Air Shoulder Rest 373  
Players Care Kits 417  
Pocket Piks 109  
Pocket Rock It 302  
Pocket Tones 72  
Poehland Shoulder Rest 374  
Polish 69-71, 372, 413  
Portnoy Mouthpieces 388  
Power Conditioners 308, 318, 329  
Power Supplies 285  
Practice Pads 184  
Preamps 308  
Prim Strings 380  
Pro Arte Strings 47, 378  
Pro Co Cables 269  
Profile Guitar Bags 20  
Pro Mark Brushes 206  
Pro Mark Drum Sticks 190-192  
Pure Sound Snares 154

## Q

Q Parts 45, 88-89, 95  
Quik Lok 120, 251, 342  
Qwik Time 424  
Qwik Tune 324

## R

Rack Cases 330-332  
Rapco Horizon Cables 267  
Rain Sticks 161  
Rat Distortion Box 290  
Ratchets 161  
Reaction Effects 289  
Recorders, Wood, Plastic 348-350  
Recording King Banjos 5  
Recording King Guitars 7-9, 12  
Reed Cards 383  
Reeds 381-386  
Reed Trimmers 382, 383  
Regal Tip Sticks 185  
Remo Drum Heads 209-216  
Remo Ethnic Percussion 166-171  
Remo Kids Percussion 170  
Remo Muffs 230  
Remo Practice Pads 184  
Remo Rototoms 179  
Remo Tambourines 176  
Resonans Shoulder Rest 373  
Rhythm Band Instruments 347  
Rhythm Tech Tambourines 175  
Rico Mouthpieces 388  
Rico Reeds 384, 385  
Riptide Ukles 16, 17  
Roche Thomas 69, 419

Rock Stops 371  
Rock 'n' Roller Carts 231  
Rocktron Effects 288, 289  
Rosin 376  
Rototoms 179  
Rovner Ligatures 409  
Ruby Tubes 258  
Runyon Mouthpieces 388  
Russell, Bill Capos 73

## S

Sacconi Tailgut 375  
Savarez Strings 58  
Saxophones 402  
Sax Stands 404-407  
Sax Straps 420-422  
Schaller Bridges 97, 99  
Schaller Machines 115  
Schaller Pick-Ups 280  
Schaller Tremolos 99  
Schilke Mouthpieces 393  
Scratcher, Guiro 161  
Seiko Metronomes 425  
Seiko Tuners 319  
Select Pick-Ups 283  
Selmer Accessories 382, 390, 392, 403, 408, 410, 418  
Selmer Lubricants 418  
Selmer Maintenance Kits 418  
Selmer Mouthpieces 390, 392  
Selmer Mutes 396  
Selmer Reeds 382  
Sennheiser Mics 240  
Shadow Pick-Ups 276, 277  
Shakers (Shekeres) 159  
Sheet Cork 413  
Sheet Music Covers 359  
Sho-All Display Equipment 432-436  
Shoulder Rests & Pads 373, 374  
Shubb Capos 73  
Silver Fox Sticks, Mallets 189  
SIT Strings 55  
Sizzler 141  
SKB Cases 22, 182, 244, 331, 332, 341, 403  
Sleigh Bells 160  
Slide Oil 418, 419  
Slide O Mix 418  
Slide Whistles 160, 351  
Smith, Ken Strings 62  
Snappy Snares 154  
Snare Cases 182  
Snare Drums 174, 181  
Snare Drum Bags 174, 182, 183  
Snare Stands 143-144, 147, 180  
Snare Wires 154  
Snark Tuners 323  
Snarling Dog Strings 51  
Song Flutes 349  
Sonnus 322  
Soundoffs 231  
Sound Post Setters 376  
Sousaphone Pads 422  
Sovtek Tubes 258  
Speaker Cables 263-271  
Speakers, Replacement 247, 248  
Speaker Stands 252-255  
Speakon Adapters & Plugs 261, 268, 313  
Speed Knobs 77, 87-91, 95  
Sperzel Machines 112  
Spider Capo 73  
Staff Liner 359  
Stage Trix 307  
Starline Batons 353  
Statuettes 428  
Steinberger String Sets 58  
Sterisol 410  
Stevens Steel 74  
Stick Caddies 208  
Stork Mouthpieces 392  
Strap Buttons 45

Strap Lock 45  
Straps 24-44, 420-422  
String Adjusters 373  
String Bases 368-370  
Strings 46-68, 377-380  
String Swing 118, 437, 438  
String Winders 72  
Super-Sensitive Strings 377  
Super Slick 419  
Super Slick Maintenance Kits 416  
Surge Protectors 318  
Sustain Pedals 302, 339  
Swabs 414, 415  
Swirlygig 153  
Switchcraft 260, 261

## T

Tablas 165  
Tablet & iPad Holders 355  
Tailgut Adjusters 373  
Tambourines 175-178  
Taktell Metronomes 424  
Talk Box 288, 296  
Tayne Mouthpieces 389  
Tee Shirts 439, 440, 442  
Telex Wireless Mics 243  
Thomastik Strings 57, 379  
Thumb Eez 413  
Tiki Ukuleles 14  
Timbales 172  
Tin Whistles 350  
Toca Tambourine 178  
Tom Tom Holders 147, 150, 152, 180  
Tone Drums 160, 178  
Tone Pro Machines 112  
Tone Pros 98, 112  
Tourte Mutes 373  
Treeworks Windchimes 123  
Tremolo Arms 77, 90, 96, 99  
Tremolo Setters 23  
Triangles 124, 178, 198  
Triangle Accessories 124, 198  
Trombone 401, 402  
Trumpet 400, 402  
Truss Rod Tools 23  
Tubes, Replacement 258, 310  
Tudor Recorders 349  
Tuners 319-324  
Tuning Forks 69  
Tuning Mics 280, 321, 324  
Twirling Batons 353

## U

Uke Bags, Cases 15, 19-21  
Uke Pegs 117  
Uke Strings 49, 57, 61, 63, 66  
Ukuleles 12-17  
Ultimate Support 343

## V

V Tech Megaphones 240  
V Tech Microphones 240  
Valentino Repair Parts 423  
Valve Guards 420  
Valve Oil 418, 419  
Vandoren Accessories 383, 395, 411, 419  
Vandoren Ligatures 411  
Vandoren Mouthpieces 387  
Vandoren Reeds 386  
Vater Drumsticks 204  
Vega Strings 51  
Veri Sonic Drum Sticks 205  
Vibra Slap 156, 160  
Violas 369  
Viola Adjusters 373  
Viola Bows 370  
Viola Outfits 369  
Viola Strings 377-380  
Violins 368, 369  
Violin Adjusters 373

Violin Bows 370  
Violin Bridges 374  
Violin Cases 371  
Violin Chinrests 373  
Violin Endpins 375  
Violin Mutes 373  
Violin Nuts 376  
Violin Outfits 368, 369  
Violin Pegs 374  
Violin Pick-ups 276, 277, 281, 284, 375  
Violin Polish 372  
Violin Rosins 376  
Violin Saddles 376  
Violin Shoulder Pads 373, 374  
Violin Stands 372  
Violin Strings 377-380  
Violin Tailpieces 375  
Violin Tools 372-377  
Visual Sound (One Spot) 285, 294  
Vito Mouthpieces 388  
Vox Tone Garage Pedals 305  
Vox Headphone Amps 303, 304

## W

Wabash Picks 103  
WD Pickguards 91, 92  
Wedgie Picks 103  
Whistles 160  
Wick, Denis Mouthpieces 394  
Wick, Denis Mutes 396  
Windchimes 123, 124  
Windscreens 256, 257  
Windy City Mutes 397, 398  
Wittner Metronomes 424  
Wolf Shoulder Rests 373  
Woodblock Holders 158  
Woodblocks 158  
Wright Way Products 354  
Wristies 438

## Y

Yamaha Care Kits 417  
Yamaha Cleaning Accessories 414  
Yamaha Headphones 246  
Yamaha Keyboards 340  
Yamaha Lubricants 419  
Yamaha Mallets 199  
Yamaha Metronomes 424  
Yamaha Mouthpieces 391  
Yamaha Mutes 399  
Yamaha Pianicas 348  
Yamaha Recorders 350  
Yamaha Silent Brass 399  
Yamaha Tuners 323, 324  
Yanagisawa Mouthpieces 391

## Z

Zerorings 230  
Zildjian 125-140, 194, 195  
Zildjian Basics 426  
Zildjian, K 126, 127, 129-131, 138  
Zildjian, Sticks 194, 195  
Zildjian A/A Custom 126, 132, 133, 138, 139  
Zildjian, ZBT 126, 136, 139  
Zildjian, ZHT 126, 135, 139  
Zildjian, FX 134  
Zildjian, Gen 137  
Zildjian Gear & Accessories 139, 140, 426  
Zildjian Gongs & Crotales/Professional Crotales 139  
Zonda Reeds 385